



中国认可  
国际互认  
检测  
TESTING  
CNAS L0446



Certificate # 2861.01



# TEST REPORT

Verified Code: 150430

<b>Report No.:</b>	E20210426746801-2	<b>Application No.:</b>	E20210426746801
<b>Client:</b>	Lumi United Technology Co., Ltd.		
<b>Address:</b>	8th Floor, JinQi Wisdom Valley, No.1 Tangling Road, Liuxian Ave, Taoyuan Residential District, Nanshan District, Shenzhen.China		
<b>Sample Description:</b>	Camera Hub G3		
<b>Model:</b>	CH-H03		
<b>Test Specification:</b>	ETSI EN 300 328 V2.2.2 (2019-07)Wideband transmission systems; Data transmission equipment operating in the 2,4 GHz band; Harmonised Standard for access to radio spectrum		
<b>Receipt Date:</b>	2021-06-09		
<b>Test Date:</b>	2021-06-14 to 2021-08-19		
<b>Issue Date:</b>	2021-08-24		
<b>Test Result:</b>	Pass		
<b>Prepared By:</b> Test Engineer  Yu Shanshan.	<b>Reviewed By:</b> Technical Manager  Wu Haoting	<b>Approved By:</b> Manager  Johnson	
<b>Other Aspects:</b>			
Note:/			
Abbreviations: ok / P = passed; fail / F = failed; n.a. / N = not applicable;			
The test result in this test report refers exclusively to the presented test sample. This report shall not be reproduced except in full, without the written approval of GRGT.			



### **DIRECTIONS OF TEST**

- 1. This station carries out test task according to the national regulation of verifications which can be traced to National Primary Standards and BIPM.**
- 2. The test report merely corresponds to the test sample. It is not permitted to copy extracts of these test result without the written permission of the test laboratory.**
- 3. If there is any objection concerning the test, the client should inform the laboratory within 15 days from the date of receiving the test report.**

## TABLE OF CONTENTS

<b>1</b>	<b>TEST RESULT SUMMARY.....</b>	<b>4</b>
<b>2</b>	<b>GENERAL DESCRIPTION OF EUT .....</b>	<b>5</b>
2.1	APPLICANT INFORMATION .....	5
2.2	MANUFACTURER.....	5
2.3	BASIC DESCRIPTION OF EUT .....	5
2.4	TEST MODE.....	6
2.5	DESCRIPTION OF ADAPTIVE EQUIPMENT .....	6
<b>3</b>	<b>LABORATORY AND ACCREDITATIONS .....</b>	<b>7</b>
3.1	LABORATORY.....	7
3.2	ACCREDITATIONS .....	7
3.3	MEASUREMENTS UNCERTAINTY .....	7
<b>4</b>	<b>EQUIPMENT AND TOOLS USED DURING TEST .....</b>	<b>9</b>
4.1	TEST EQUIPMENT AND TOOLS .....	9
4.2	LOCAL SUPPORTIVE INSTRUMENTS.....	10
4.3	TEST SOFTWARE.....	10
<b>5</b>	<b>RADIO TECHNICAL REQUIREMENT SPECIFICATION .....</b>	<b>11</b>
5.1	RF OUTPUT POWER .....	11
5.1.1	<i>LIMIT</i> .....	11
5.1.2	<i>TEST CONFIGURATION</i> .....	11
5.1.3	<i>TEST PROCEDURES</i> .....	11
5.1.4	<i>TEST RESULTS</i> .....	12
5.2	POWER SPECTRAL DENSITY .....	15
5.2.1	<i>LIMIT</i> .....	15
5.2.2	<i>TEST CONFIGURATION</i> .....	15
5.2.3	<i>TEST PROCEDURES</i> .....	15
5.2.4	<i>TEST RESULTS</i> .....	16
5.3	ADAPTIVITY .....	19
5.3.1	<i>LIMIT</i> .....	19
5.3.2	<i>TEST CONFIGURATION</i> .....	19
5.3.3	<i>TEST PROCEDURES</i> .....	19
5.3.4	<i>TEST RESULTS</i> .....	20
5.4	OCCUPIED CHANNEL BANDWIDTH .....	28
5.4.1	<i>LIMIT</i> .....	28
5.4.2	<i>TEST CONFIGURATION</i> .....	28
5.4.3	<i>TEST PROCEDURES</i> .....	28
5.4.4	<i>TEST RESULTS</i> .....	29
5.5	TRANSMITTER UNWANTED EMISSIONS IN THE OUT-OF-BAND DOMAIN.....	33
5.5.1	<i>LIMIT</i> .....	33
5.5.2	<i>TEST CONFIGURATION</i> .....	33
5.5.3	<i>TEST PROCEDURES</i> .....	33
5.5.4	<i>Test Results</i> .....	34
5.6	TRANSMITTER UNWANTED EMISSIONS IN THE SPURIOUS DOMAIN.....	37
5.6.1	<i>LIMIT</i> .....	37
5.6.2	<i>TEST CONFIGURATION</i> .....	38
5.6.3	<i>TEST PROCEDURES</i> .....	38
5.6.4	<i>DATA SAMPLE</i> .....	39
5.6.5	<i>TEST RESULTS</i> .....	40
5.7	RECEIVER SPURIOUS EMISSIONS .....	56
5.7.1	<i>LIMIT</i> .....	56
5.7.2	<i>TEST CONFIGURATION</i> .....	56
5.7.3	<i>TEST PROCEDURES</i> .....	57
5.7.4	<i>DATA SAMPLE</i> .....	58
5.7.5	<i>TEST RESULTS</i> .....	59
5.8	RECEIVER BLOCKING.....	71

5.8.1	<i>LIMIT</i> .....	71
5.8.2	<i>TEST CONFIGURATION</i> .....	73
5.8.3	<i>TEST PROCEDURES</i> .....	73
5.8.4	<i>TEST RESULTS</i> .....	75
<b>6</b>	<b>APPENDIX A. PHOTOGRAPH OF THE TEST CONNECTION DIAGRAM</b> .....	<b>76</b>
<b>7</b>	<b>APPENDIX B. PHOTOGRAPH OF THE EUT</b> .....	<b>76</b>

## 1 TEST RESULT SUMMARY

Test Item	Test mode	Test Requirement	Test Method	Class / Severity	Test Result
<b>1. Transmitter Part</b>					
RF Output Power	TX mode	EN300 328 V2.2.2/4.3.2.2	EN300 328 V2.2.2/5.4.2.2.1	Meet requirements: EN300 328 V2.2.2/4.3.2.2	PASS
Power Spectral Density	TX mode	EN300 328 V2.2.2/4.3.2.3	EN300 328 V2.2.2/5.4.3.2.1	Meet requirements: EN300 328 V2.2.2/4.3.2.3	PASS
Duty Cycle, Tx-sequence, Tx-gap	TX mode	EN300 328 V2.2.2/4.3.2.4	EN300 328 V2.2.2/5.4.2.2.1	Meet requirements: EN300 328 V2.2.2/4.3.2.4	N/A
Medium Utilisation (MU) factor	TX mode	EN300 328 V2.2.2/4.3.2.5	EN300 328 V2.2.2/5.4.2.2	Meet requirements: EN300 328 V2.2.2/4.3.2.5	N/A
Adaptivity	TX mode	EN300 328 V2.2.2/4.3.2.6	EN300 328 V2.2.2/5.4.6.2.1	Meet requirements: EN300 328 V2.2.2/4.3.2.6	PASS
Occupied Channel Bandwidth	TX mode	EN300 328 V2.2.2/4.3.2.7	EN300 328 V2.2.2/5.4.7.2.1	Meet requirements: EN300 328 V2.2.2/4.3.2.7	PASS
Transmitter unwanted emissions in the out-of-band domain	TX mode	EN300 328 V2.2.2/4.3.2.8	EN300 328 V2.2.2/5.4.8.2.1	Meet requirements: EN300 328 V2.2.2/4.3.2.8	PASS
Transmitter unwanted emissions in the spurious domain	TX mode	EN300 328 V2.2.2/4.3.2.9	EN300 328 V2.2.2/5.4.9.2.2	Meet requirements: EN300 328 V2.2.2/4.3.2.9	PASS
<b>2. Receiver Part</b>					
Receiver spurious emissions	RX mode	EN300 328 V2.2.2/4.3.2.10	EN300 328 V2.2.2/5.4.10.2.2	Meet requirements: EN300 328 V2.2.2/ 4.3.2.10	PASS
Receiver Blocking	RX mode	EN300 328 V2.2.2/4.3.2.11	EN300 328 V2.2.2/5.4.11.2.1	Meet requirements: EN300 328 V2.2.2/ 4.3.2.11	PASS

Note: N/A = Not Applicable

## 2 GENERAL DESCRIPTION OF EUT



### 2.1 APPLICANT INFORMATION

Name: Lumi United Technology Co., Ltd.  
Address: 8th Floor, JinQi Wisdom Valley, No.1 Tangling Road, Liuxian Ave,  
Taoyuan Residential District, Nanshan District, Shenzhen.China

### 2.2 MANUFACTURER

Name: Lumi United Technology Co., Ltd.  
Address: 8th Floor, JinQi Wisdom Valley, No.1 Tangling Road, Liuxian Ave,  
Taoyuan Residential District, Nanshan District, Shenzhen.China

### 2.3 BASIC DESCRIPTION OF EUT

Product Name: Camera Hub G3  
Product Model: CH-H03  
Adding Model: /  
Trade Name: Aqara  
Adapter 1-EU Plug  
Model:A70-050200U-EU1  
Input:100-240V~ 50/60Hz 0.35A  
Output:5.0V  2.0A 10.0W  
Power Supply:  
Adapter 2-UK Plug  
Model:A812-050200U-UK1  
Input:100-240V~ 50/60Hz 0.35A  
Output:5.0V  2.0A 10.0W  
Frequency Band: 2412MHz-2472MHz for 802.11b/g/n HT20,  
2422MHz-2462MHz for 802.11n HT40,  
DSSS for 802.11b mode;  
Modulation Type: OFDM for 802.11g mode;  
OFDM for 802.11n mode.  
Antenna  
Specification: Internal antenna with 3dBi gain (Max.)  
Temperature  
Range: -10°C~40°C  
Hardware  
Version: A20-GHC01-MIAN-X4  
Software  
Version: 3.2.8\_0003.0004  
Sample  
submitting way:  Provided by customer  Sampling  
Sample No: E20210426746801-0004, E20210426746801-0008  
Note: /

## 2.4 TEST MODE

Mode No.	Description of the modes
1	2.4G Wi-Fi TX mode
2	2.4G Wi-Fi RX mode
3	Normal 2.4G Wi-Fi mode

## 2.5 DESCRIPTION OF ADAPTIVE EQUIPMENT

The type of modulation used by the equipment	<input type="checkbox"/> FHSS	<input checked="" type="checkbox"/> other forms of modulation	<input type="checkbox"/> Non-FHSS	
Adaptive / non-adaptive equipment	<input type="checkbox"/> Non-adaptive Equipment	<input checked="" type="checkbox"/> adaptive Equipment without the possibility to switch to a non-adaptive mode	<input type="checkbox"/> adaptive Equipment which can also operate in a non-adaptive mode	
The equipment has an implemented	<input type="checkbox"/> Frame Based equipment	<input checked="" type="checkbox"/> Load Based equipment	<input type="checkbox"/> non-LBT based DAA mechanism	<input type="checkbox"/> other
Device Class	<input checked="" type="checkbox"/> Wi-Fi	<input type="checkbox"/> BT 2.1/3.0	<input type="checkbox"/> BT 4.0	<input type="checkbox"/> BT 5.0
Wi-Fi Channel Bandwidth	<input checked="" type="checkbox"/> 20MHz	<input checked="" type="checkbox"/> 40MHz	<input type="checkbox"/> 80MHz	<input type="checkbox"/> 160MHz
Antenna Gain	<input checked="" type="checkbox"/> Antenna1 3dBi	<input type="checkbox"/> Antenna 2 dBi	<input type="checkbox"/> Antenna 3 dBi	<input type="checkbox"/> Antenna 4 dBi
Beamforming Gain	<input type="checkbox"/> Yes, dBi	<input checked="" type="checkbox"/> No		
Extreme operating conditions	<input checked="" type="checkbox"/> Operating temperature range:	<input checked="" type="checkbox"/> Min -10°C	<input checked="" type="checkbox"/> Max 40°C	
Blocking	<input checked="" type="checkbox"/> PER	<input type="checkbox"/> The manufacturer may declare alternative performance criteria		
Geo-location capability supported by the equipment	<input type="checkbox"/> Yes	<input checked="" type="checkbox"/> No		

### 3 LABORATORY AND ACCREDITATIONS

#### 3.1 LABORATORY

The tests & measurements refer to this report were performed by Shenzhen EMC Laboratory of Guangzhou GRG Metrology & Test Co.,Ltd.

Addr.: No.1301 Guanguang Road Xinlan Community, Guanlan Street, Longhua District Shenzhen, 518110, People's Republic of China.

P.C.: 518000

Tel : 0755-61180008

Fax: 0755-61180008

#### 3.2 ACCREDITATIONS

Our laboratories are accredited and approved by the following approval agencies according to GB/T 27025(ISO/IEC 17025:2017)

**USA** A2LA(Certificate#:2861.01)  
**China** CNAS(L0446)

The measuring facility of laboratories has been authorized or registered by the following approval agencies.

**Canada** Industry Canada  
**USA** FCC

Copies of granted accreditation certificates are available for downloading from our web site, <http://www.grgtest.com>

#### 3.3 MEASUREMENTS UNCERTAINTY

Where relevant, the following measurement uncertainty levels have been estimated for tests performed on the EUT as specified in ETSI EN TR 100 028-1 (i.15) and ETSI EN 100 028-2 (i.8):

Measurement		Frequency	Uncertainty
Radiated Emission	Horizontal	30MHz~1000MHz	4.3dB
		1GHz~18GHz	5.6dB
	Vertical	30MHz~1000MHz	4.3dB
		1GHz~18GHz	5.6dB

Measurement		Frequency	Uncertainty
Radiated Emission	Horizontal	30MHz~1000MHz	4.3dB
		1GHz~18GHz	5.6dB
	Vertical	30MHz~1000MHz	4.3dB
		1GHz~18GHz	5.6dB
Conduction Emission		9 kHz ~ 150 kHz	2.8 dB
		150 kHz ~ 10 MHz	2.8 dB
		10 MHz ~ 30 MHz	2.2 dB



Measurement	Uncertainty
RF frequency	$6.0 \times 10^{-6}$
RF power conducted	0.78 dB
Occupied channel bandwidth	0.4 dB
Unwanted emission, conducted	0.68 dB
Humidity	6 %
Temperature	2 °C

This uncertainty represents an expanded uncertainty factor of  $k=2$ .

## 4 EQUIPMENT AND TOOLS USED DURING TEST

### 4.1 TEST EQUIPMENT AND TOOLS

Name of Equipment	Manufacturer	Model	Serial Number	Calibration Due
<b>Maximum transmit power &amp; Maximum e.i.r.p. spectral density &amp; occupied channel bandwidth &amp; Transmitter unwanted emissions in the out-of-band domain</b>				
Simultaneous sampling DAQ	Tonscend	JS0806-2	186060020	2021-10-08
Spectrum Analyzer	Agilent	N9020A	MY50510140	2021-12-15
Temperature & humidity chamber	HOSON	HS01060SDF	1910008401	2021-10-15
BT/Wi-Fi System	tonscend	Js1120-3		
<b>Transmitter unwanted emissions in the spurious domain &amp; Receiver spurious emissions</b>				
EXA signal analyzer	Agilent	N9020A	MY52221469	2022-04-16
Bi-log Antenna	Schwarzbeck	VULB9163	01279	2022-02-25
Horn Antenna	Schwarzbeck	BBHA9120D (1201)	02143	2021-12-17
Horn Antenna	Schwarzbeck	BBHA9170	BBHA9170-497	2021-11-05
Amplifier	tonscend	TAP9E6343	AP20E806065	2022-06-03
Amplifier	tonscend	TAP01018048	AP20E8060075	2022-06-07
Test S/W	tonscend	JS36-RSE/2.5.1.5		
<b>Adaptivity</b>				
Spectrum Analyzer	Agilent	N9020A	MY50510140	2021-12-15
Vector Signal Generator	Agilent	N5182A	MY50142870	2021-10-08
Signal Generator	Anritsu	MG3694A	#050125	2022-04-23
BT/Wi-Fi System	tonscend	Js1120-3		
<b>Receiver Blocking</b>				
Vector Signal Generator	Agilent	N5182A	MY50142870	2021-10-08
Wideband radio Communication Tester	R&S	CMW500	144611-nC	2022-06-10
BT/Wi-Fi System	tonscend	Js1120-3		

#### 4.2 LOCAL SUPPORTIVE INSTRUMENTS

Name of Equipment	Manufacturer	Model	Serial Number	Note
Notebook	LENOVO	TianYi 310-14ISK	MP18DLC6	/
/	/	/	/	/
<b>Cable</b>				
/	/	/	/	/

Note: <sup>(1)</sup> The notebook is just used to produce fixed frequency transmitting.

#### 4.3 TEST SOFTWARE

Software version	Test level
QCOM_V1.0	11b:44, 11g:52, 11n:52

## 5 RADIO TECHNICAL REQUIREMENT SPECIFICATION

### 5.1 RF OUTPUT POWER

Test Requirement: EN300 328 V2.2.2/ 4.3.2.2

Test Method: EN300 328 V2.2.2/5.4.2.2.1

#### 5.1.1 LIMIT

The RF output power for non-FHSS equipment shall be equal to or less than 20 dBm.

#### 5.1.2 TEST CONFIGURATION

Conducted measurement:

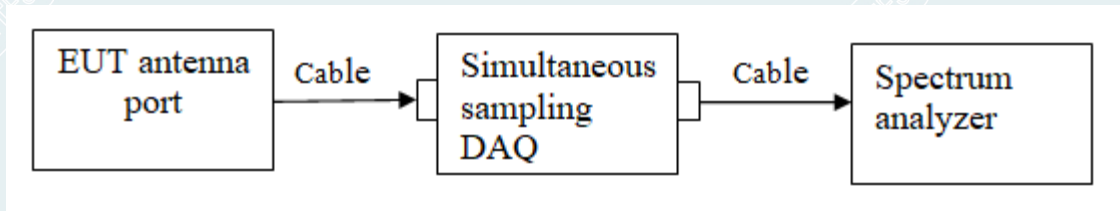

#### 5.1.3 TEST PROCEDURES

Test procedure: Test procedure is according to Clause 5.4.2.2.1 of EN 300 328 V2.2.2

Test channel: 2412MHz, 2442MHz, 2472MHz for 802.11b/g/n HT20

2422MHz, 2442MHz, 2462MHz for 802.11n HT40

Test condition: Normal and extreme test conditions.

Test condition	Temperature(°C)
Normal condition	23.4°C
Extreme condition	Minimum Temperature: -10°C
	Maximum Temperature: 40°C

Remark: /

**5.1.4 TEST RESULTS**

Test Date (yy-mm-dd): 2021-07-29

Test environment: Normal condition: Temp: 23.4 Humid:49%

Extreme test conditions: Minimum Temp: -10°C

Maximum Temp: 40°C

Type: 802.11b

Test content		Max. e.i.r.p. Limit(dBm)	Test Data (dBm)			Conclusion
			Conducted Power (dBm)	Antenna Gain (dBi)	e.i.r.p. (dBm)	
<b>(1). Measurement Temperature: Minimum</b>						
Test Frequency	Lowest frequency channel 2412MHz	20	15.77	3	18.77	PASS
	Middle frequency channel 2442MHz	20	15.10	3	18.10	PASS
	Highest frequency channel 2472MHz	20	14.77	3	17.77	PASS
<b>(2). Measurement Temperature: Normal</b>						
Test Frequency	Lowest frequency channel 2412MHz	20	15.60	3	18.60	PASS
	Middle frequency channel 2442MHz	20	14.89	3	17.89	PASS
	Highest frequency channel 2472MHz	20	14.56	3	17.56	PASS
<b>(3). Measurement Temperature: Maximum</b>						
Test Frequency	Lowest frequency channel 2412MHz	20	15.15	3	18.15	PASS
	Middle frequency channel 2442MHz	20	14.90	3	17.90	PASS
	Highest frequency channel 2472MHz	20	14.58	3	17.58	PASS

Type: 802.11g

Test content		Max. e.i.r.p. Limit(dBm)	Test Data (dBm)			Conclusion
			Conducted Power (dBm)	Antenna Gain (dBi)	e.i.r.p. (dBm)	
(1). Measurement Temperature: Minimum						
Test Frequency	Lowest frequency channel 2412MHz	20	14.09	3	17.09	PASS
	Middle frequency channel 2442MHz	20	14.09	3	17.09	PASS
	Highest frequency channel 2472MHz	20	13.97	3	16.97	PASS
(2). Measurement Temperature: Normal						
Test Frequency	Lowest frequency channel 2412MHz	20	14.11	3	17.11	PASS
	Middle frequency channel 2442MHz	20	14.11	3	17.11	PASS
	Highest frequency channel 2472MHz	20	13.82	3	16.82	PASS
(3). Measurement Temperature: Maximum						
Test Frequency	Lowest frequency channel 2412MHz	20	13.89	3	16.89	PASS
	Middle frequency channel 2442MHz	20	13.96	3	16.96	PASS
	Highest frequency channel 2472MHz	20	13.86	3	16.86	PASS

Type: 802.11n20

Test content		Max. e.i.r.p. Limit(dBm)	Test Data (dBm)			Conclusion
			Conducted Power (dBm)	Antenna Gain (dBi)	e.i.r.p. (dBm)	
(1). Measurement Temperature: Minimum						
Test Frequency	Lowest frequency channel 2412MHz	20	14.19	3	17.19	PASS
	Middle frequency channel 2442MHz	20	13.96	3	16.96	PASS
	Highest frequency channel 2472MHz	20	13.37	3	16.37	PASS
(2). Measurement Temperature: Normal						
Test Frequency	Lowest frequency channel 2412MHz	20	13.98	3	16.98	PASS
	Middle frequency channel 2442MHz	20	13.94	3	16.94	PASS
	Highest frequency channel 2472MHz	20	13.54	3	16.54	PASS
(3). Measurement Temperature: Maximum						
Test Frequency	Lowest frequency channel 2412MHz	20	13.93	3	16.93	PASS
	Middle frequency channel 2442MHz	20	13.63	3	16.63	PASS
	Highest frequency channel 2472MHz	20	13.28	3	16.28	PASS

Type: 802.11n40

Test content		Max. e.i.r.p. Limit(dBm)	Test Data (dBm)			Conclusion
			Conducted Power (dBm)	Antenna Gain (dBi)	e.i.r.p. (dBm)	
<b>(1). Measurement Temperature: Minimum</b>						
Test Frequency	Lowest frequency channel 2422MHz	20	13.72	3	16.72	PASS
	Middle frequency channel 2442MHz	20	13.58	3	16.58	PASS
	Highest frequency channel 2462MHz	20	13.59	3	16.59	PASS
<b>(2). Measurement Temperature: Normal</b>						
Test Frequency	Lowest frequency channel 2422MHz	20	13.89	3	16.89	PASS
	Middle frequency channel 2442MHz	20	13.94	3	16.94	PASS
	Highest frequency channel 2462MHz	20	13.74	3	16.74	PASS
<b>(3). Measurement Temperature: Maximum</b>						
Test Frequency	Lowest frequency channel 2422MHz	20	13.56	3	16.56	PASS
	Middle frequency channel 2442MHz	20	13.44	3	16.44	PASS
	Highest frequency channel 2462MHz	20	13.36	3	16.36	PASS

## 5.2 POWER SPECTRAL DENSITY

Test Requirement: EN300 328 V2.2.2/4.3.2.3

Test Method: EN300 328 V2.2.2/5.4.3.2.1

### 5.2.1 LIMIT

This requirement applies to all types of equipment using wide band modulations other than FHSS.

For equipment using wide band modulations other than FHSS, the maximum Power Spectral Density is limited to 10 dBm per MHz.

### 5.2.2 TEST CONFIGURATION

Conducted measurement:

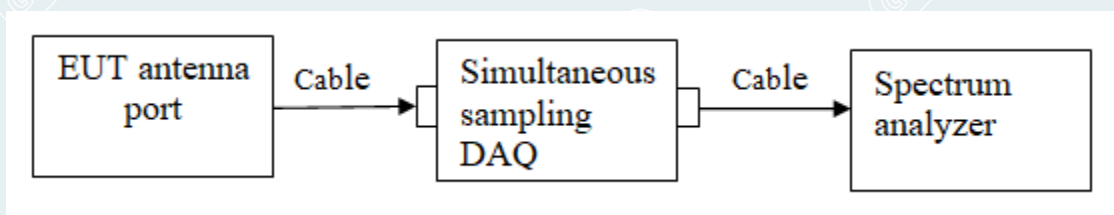

### 5.2.3 TEST PROCEDURES

Test condition: Normal test conditions

Test channel: 2412MHz, 2442MHz, 2472MHz for 802.11b/g/n HT20

2422MHz, 2442MHz, 2462MHz for 802.11n HT40

Test procedure: Test procedure is according to Clause 5.4.3.2.1 of EN 300 328 V2.2.2

Remark: /



**5.2.4 TEST RESULTS**

Test Date (yy-mm-dd): 2021-08-06

Test environment: Normal condition:

Temp: 23.4°C, Humid:49%

TestMode	Antenna	Channel	PSD[dBm/MHz]	Limit[dBm/MHz]	Verdict
802.11b	antenna 1	2412	9.63	10	PASS
	antenna 1	2442	9.02	10	PASS
	antenna 1	2472	8.54	10	PASS
802.11g	antenna 1	2412	5.54	10	PASS
	antenna 1	2442	5.58	10	PASS
	antenna 1	2472	5.50	10	PASS
802.11 N20	antenna 1	2412	5.23	10	PASS
	antenna 1	2442	5.20	10	PASS
	antenna 1	2472	4.83	10	PASS
802.11 N40	antenna 1	2422	2.21	10	PASS
	antenna 1	2442	2.13	10	PASS
	antenna 1	2462	2.04	10	PASS

Test Graphs  
Type: 802.11b

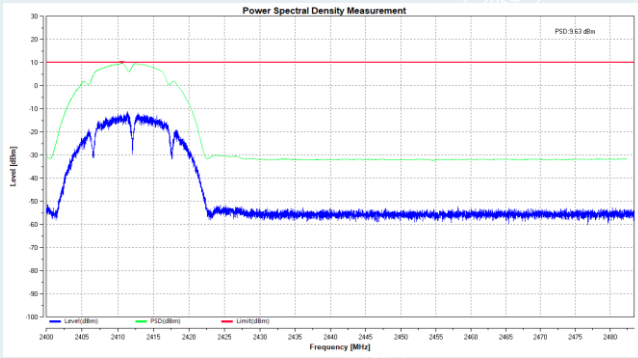

Lowest Frequency: 2412MHz

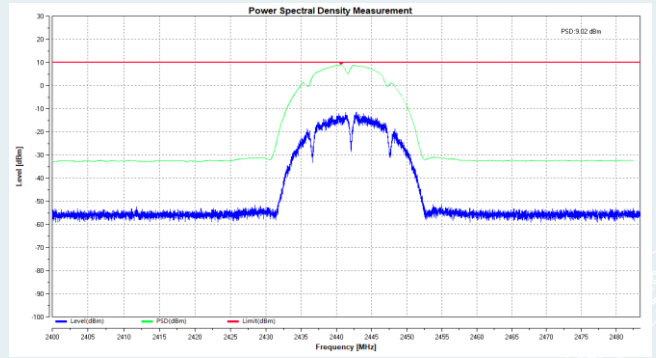

Middle Frequency: 2442MHz

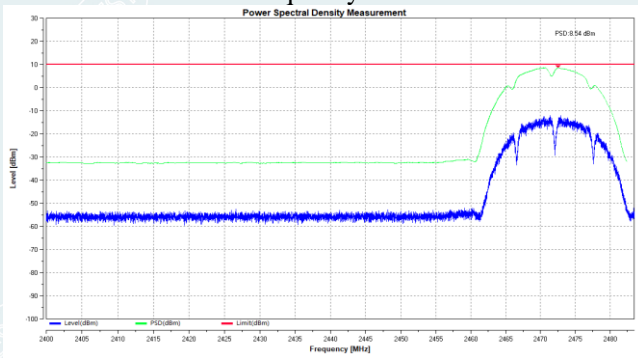

Highest Frequency: 2472MHz

Type: 802.11g

Lowest Frequency: 2412MHz

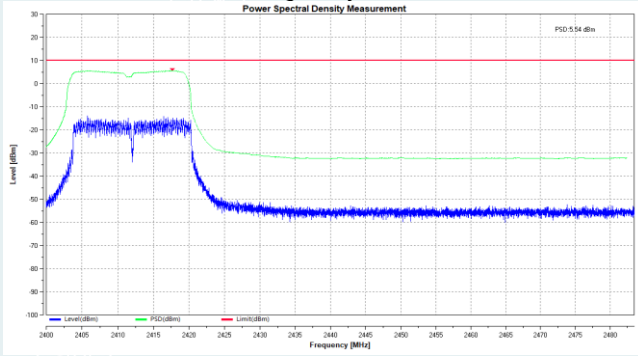

Middle Frequency: 2442MHz

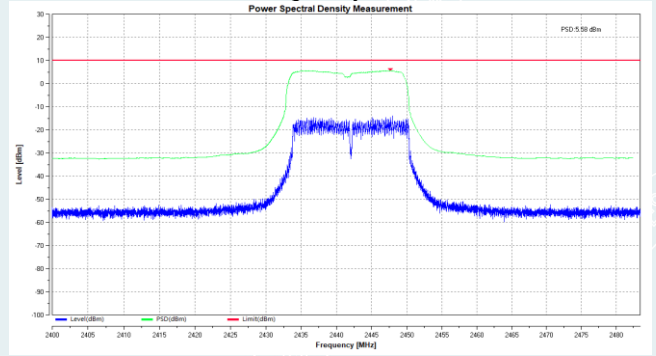

Highest Frequency: 2472MHz

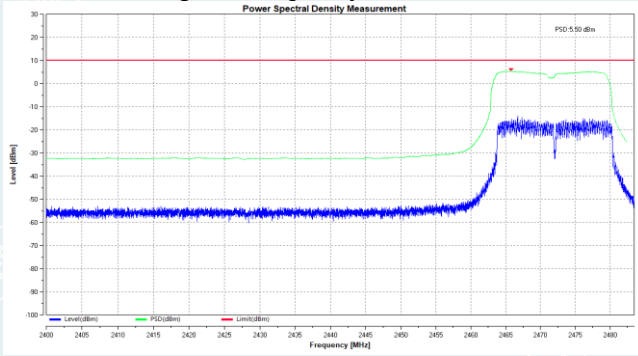

Type: 802.11n20

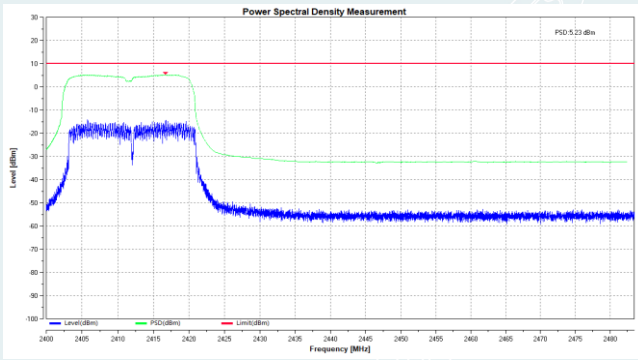

Lowest Frequency: 2412MHz

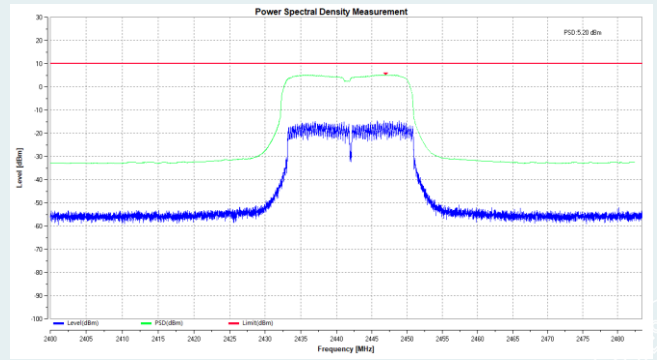

Middle Frequency: 2442MHz

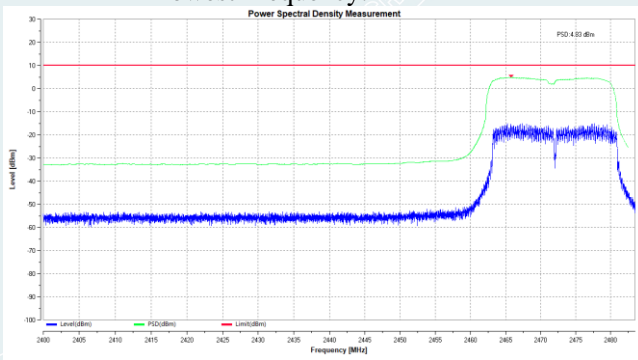

Highest Frequency: 2472MHz

Type: 802.11n40

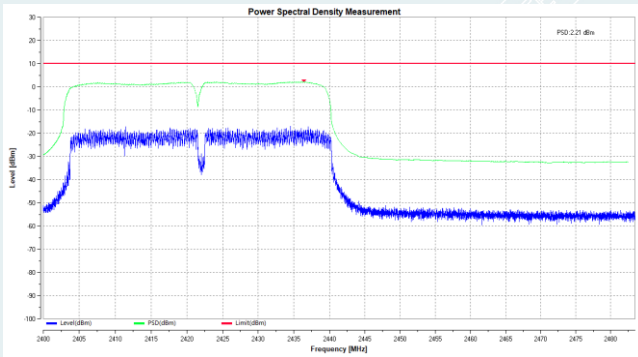

Lowest Frequency: 2422MHz

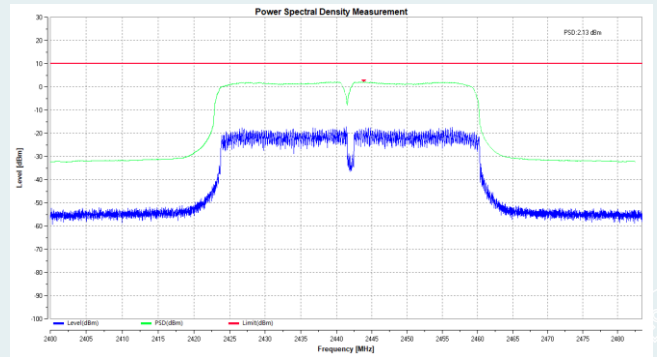

Middle Frequency: 2442MHz

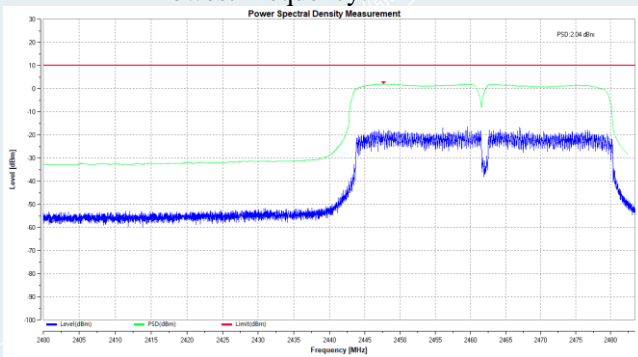

Highest Frequency: 2462MHz

### 5.3 ADAPTIVITY

Test Requirement: EN300 328 V2.2.2/ 4.3.2.6

Test Method: EN300 328 V2.2.2/5.4.6.2.1

#### 5.3.1 LIMIT

For Adaptive Non-FHSS equipment

Clear Channel Assessment 18us - 160us

Channel Occupancy time < 13ms

Short Control Signaling Transmissions shall have a maximum TxOn/(TxOn+TxOff) ratio of 10% within any observation period of 50ms or within an observation period equal to the dwell time, whichever is less.

#### 5.3.2 TEST CONFIGURATION

Conducted measurement:

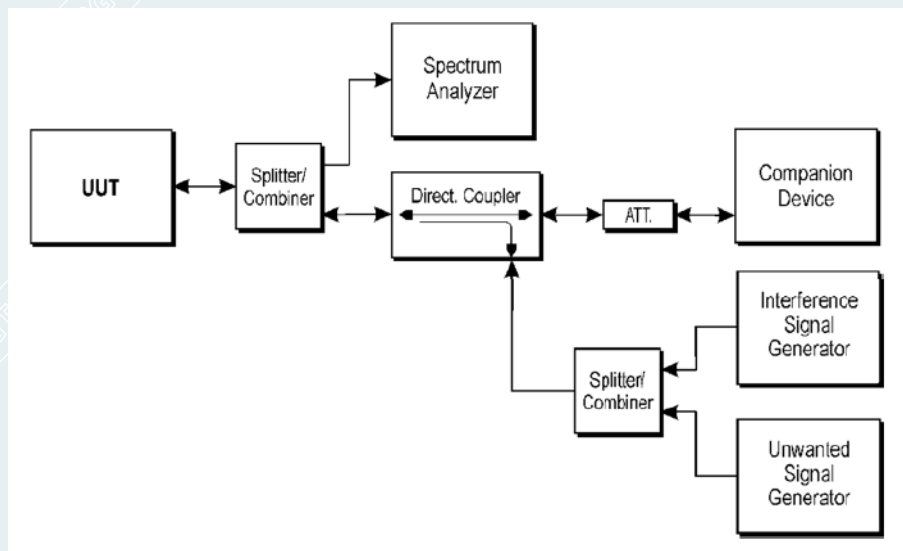

#### 5.3.3 TEST PROCEDURES

Test condition: Normal test conditions

Test channel: 2412MHz, 2472MHz for 802.11b/g/n HT20

2422MHz, 2462MHz for 802.11n HT40

Test procedure: Test procedure is according to Clause 5.4.6.2.1 of EN 300 328 V2.2.2

Remark: /

### 5.3.4 TEST RESULTS

Test Date (yy-mm-dd): 2021-08-06

Test environment: Normal condition:

Temp: 23.4°C, Humid:49%

TestMode	Antenna	Channel	Max.COT [ms]	Limit[ms]	Min.Idle Time[ms]	Limit[ms]	Verdict
11b	Ant1	2412	1.517	13	0.467	0.018	PASS
		2472	1.518	13	0.274	0.018	PASS
11g	Ant1	2412	2.161	13	0.079	0.018	PASS
		2472	0.295	13	0.028	0.018	PASS
11n20	Ant1	2412	3.182	13	0.066	0.018	PASS
		2472	2.414	13	0.054	0.018	PASS
11n40	Ant1	2422	1.249	13	0.062	0.018	PASS
		2462	2.663	13	0.063	0.018	PASS

TestMode	Antenna	Channel	Add Signal Type	Add Signal Time[ms]	Add Signal Level[dbm]	Max. Short Time[%]	Limit [%]	Verdict
11b	Ant1	2412	AWGN	3000	-68.60	1.40	10	PASS
			CW	65998	-32.00	0.00	10	PASS
		2472	AWGN	3000	-67.56	1.40	10	PASS
			CW	65998	-32.00	0.00	10	PASS
11g	Ant1	2412	AWGN	3000	-67.11	1.40	10	PASS
			CW	65998	-32.00	0.00	10	PASS
		2472	AWGN	3000	-66.82	1.40	10	PASS
			CW	65998	-32.00	0.00	10	PASS
11n20	Ant1	2412	AWGN	3000	-66.98	1.40	10	PASS
			CW	65998	-32.00	0.00	10	PASS
		2472	AWGN	3000	-66.54	0.00	10	PASS
			CW	65998	-32.00	0.00	10	PASS
11n40	Ant1	2422	AWGN	3000	-66.89	1.60	10	PASS
			CW	65998	-32.00	0.00	10	PASS
		2462	AWGN	3000	-66.74	1.40	10	PASS
			CW	65998	-32.00	0.00	10	PASS

Test Graphs

Station mode:

802.11b

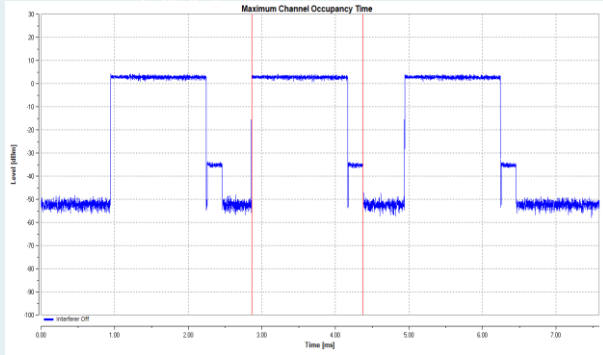

Lowest Frequency: 2412MHz

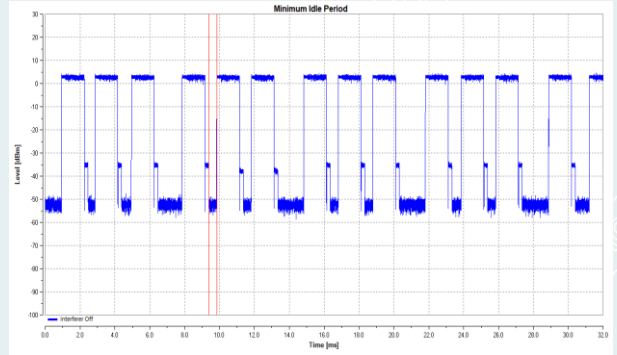

Lowest Frequency: 2412MHz

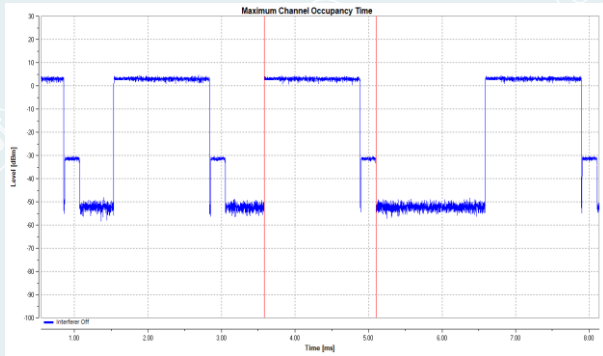

Highest Frequency: 2472MHz

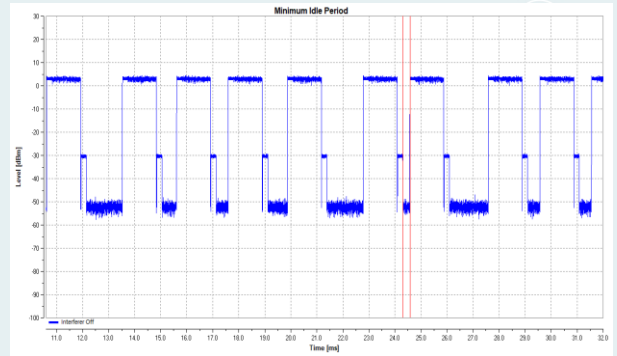

Highest Frequency: 2472MHz

802.11g

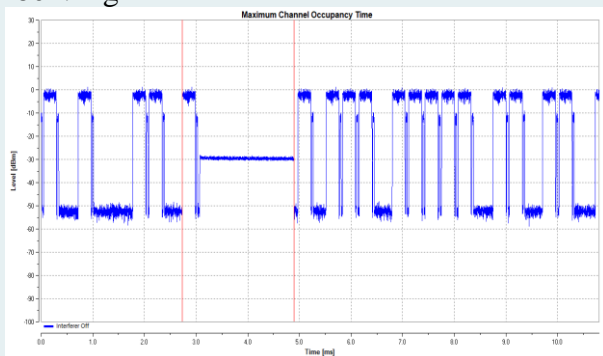

Lowest Frequency: 2412MHz

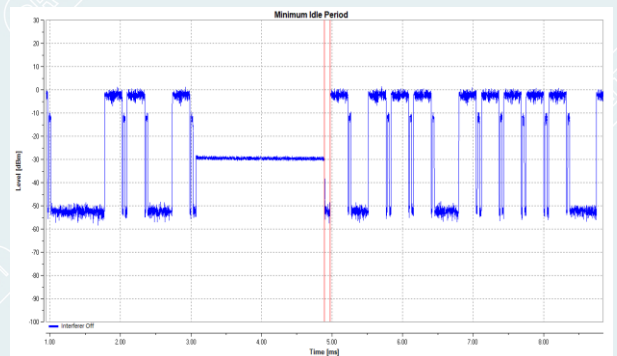

Lowest Frequency: 2412MHz

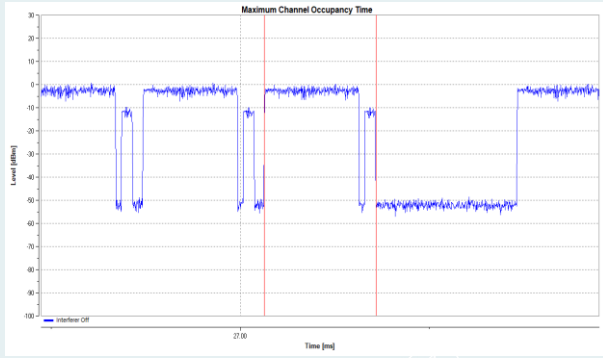

Highest Frequency: 2472MHz

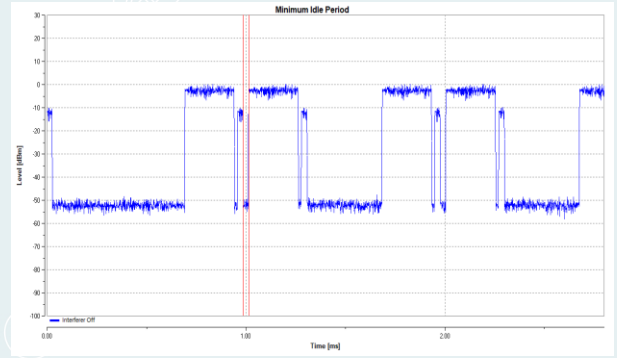

Highest Frequency: 2472MHz

802.11n20SISO

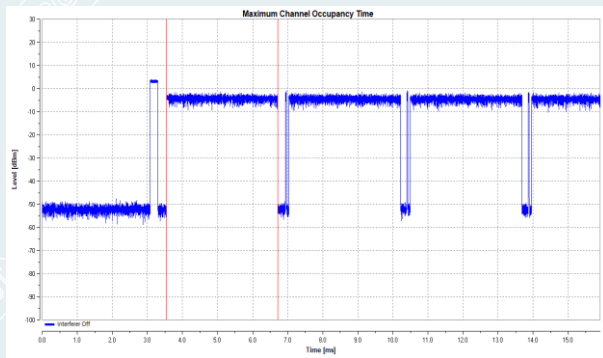

Lowest Frequency: 2412MHz

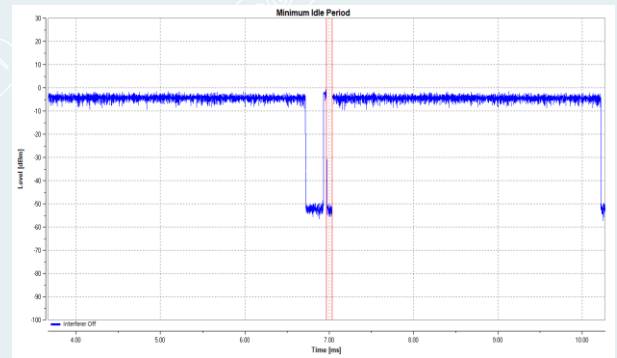

Lowest Frequency: 2412MHz

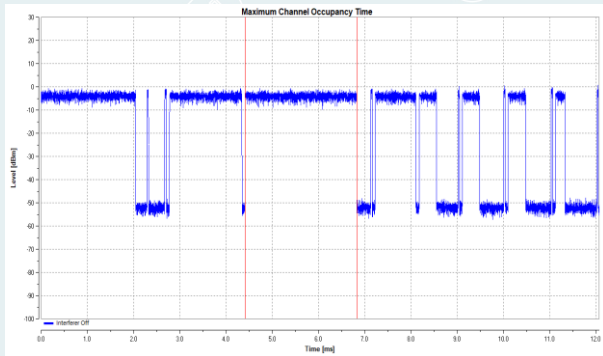

Highest Frequency: 2472MHz

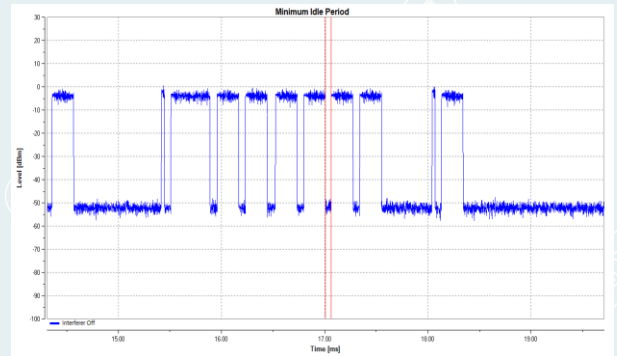

Highest Frequency: 2472MHz

### 802.11n40SISO

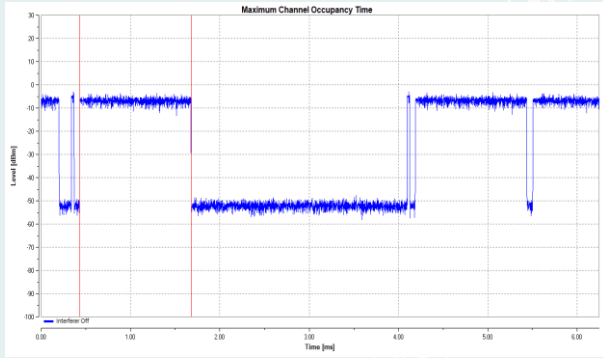

Lowest Frequency: 2422MHz

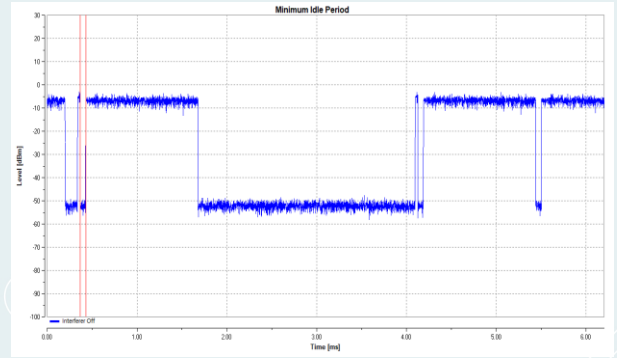

Lowest Frequency: 2422MHz

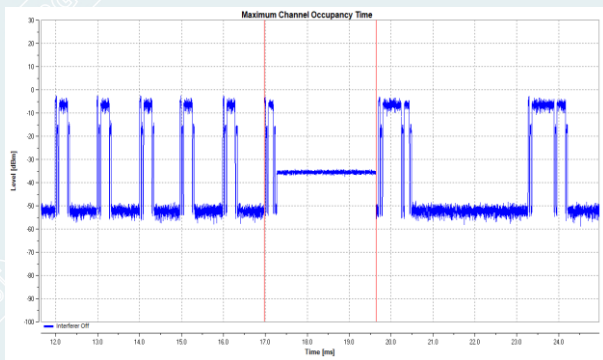

Highest Frequency: 2462MHz

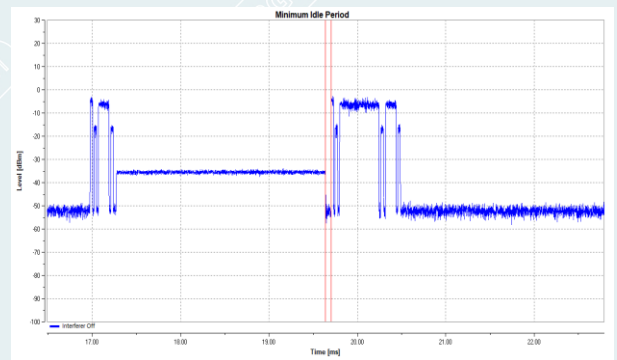

Highest Frequency: 2462MHz

### AP mode:

### 802.11b

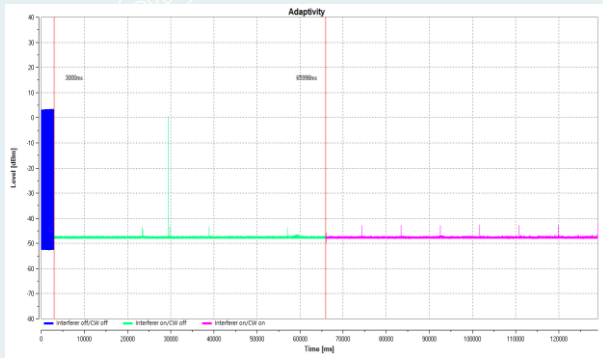

Lowest Frequency: 2412MHz

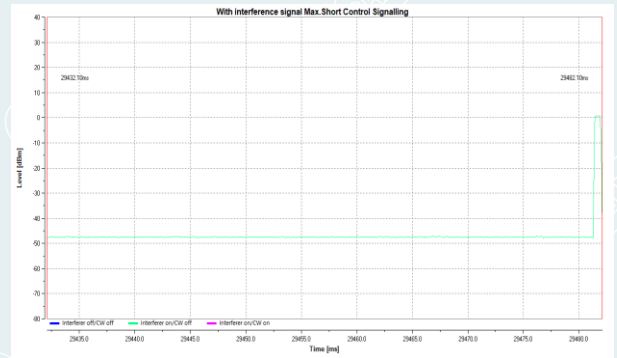

Lowest Frequency: 2412MHz

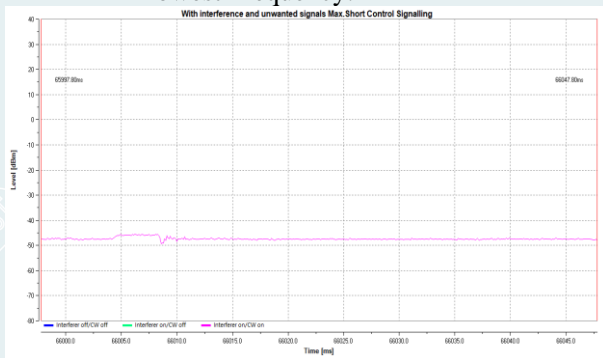

Lowest Frequency: 2412MHz



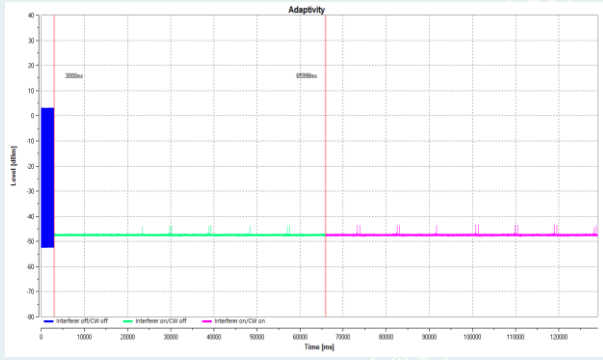

Highest Frequency: 2472MHz

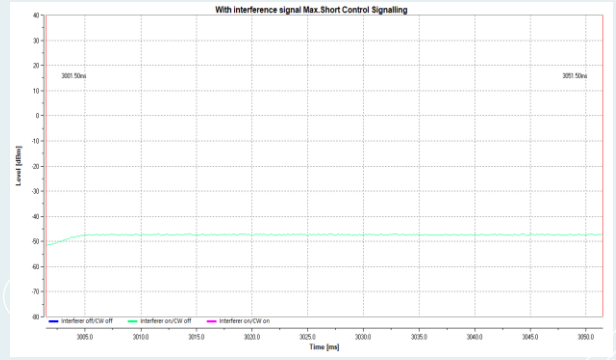

Highest Frequency: 2472MHz

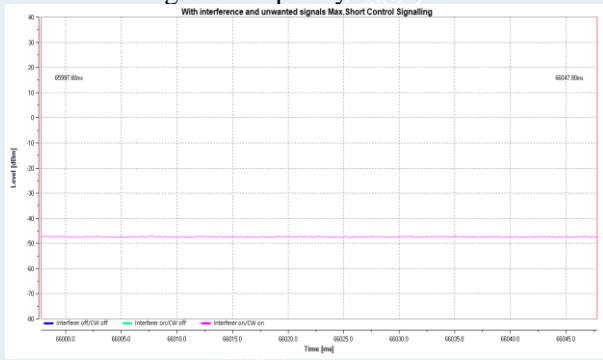

Highest Frequency: 2472MHz

802.11g

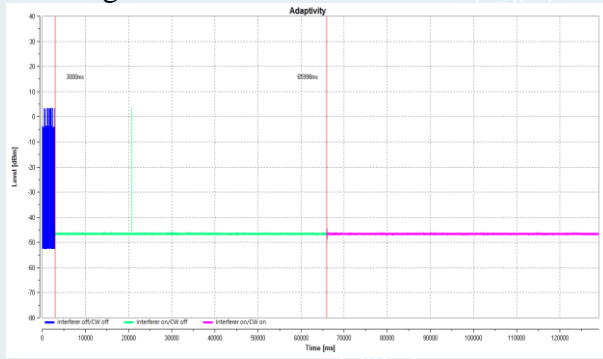

Lowest Frequency: 2412MHz

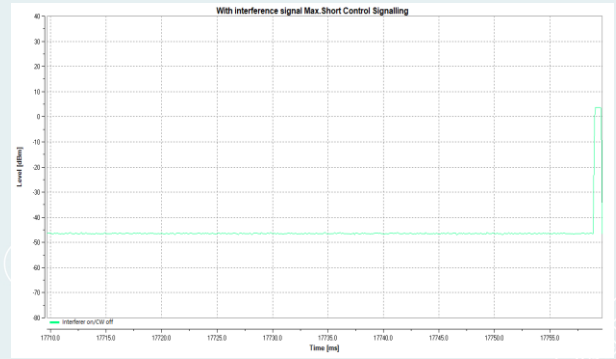

Lowest Frequency: 2412MHz

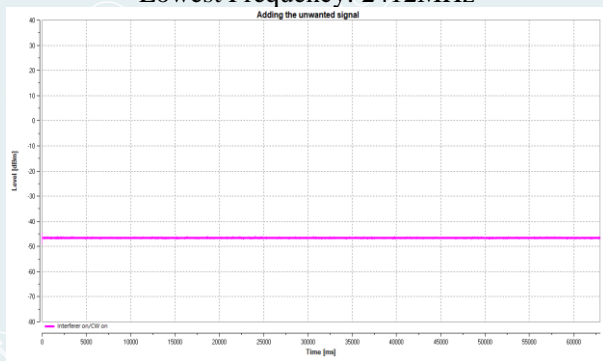

Lowest Frequency: 2412MHz

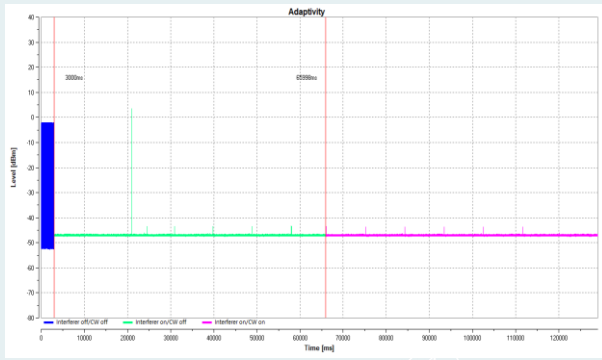

Highest Frequency: 2472MHz

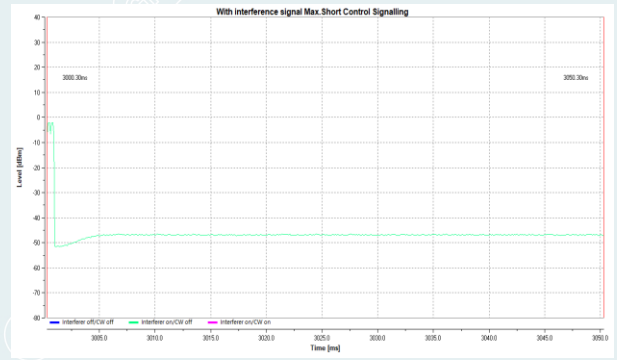

Highest Frequency: 2472MHz

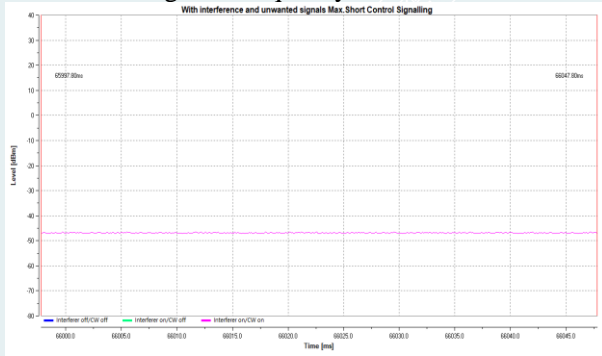

Highest Frequency: 2472MHz

802.11n20SISO

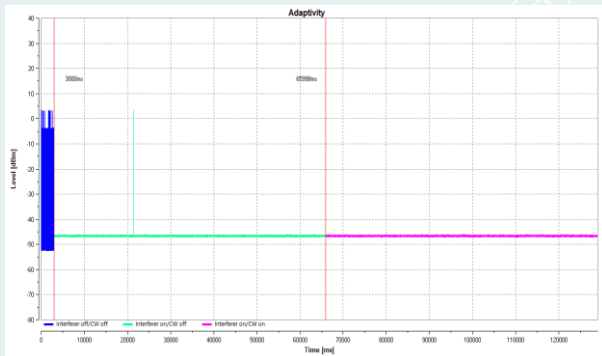

Lowest Frequency: 2412MHz

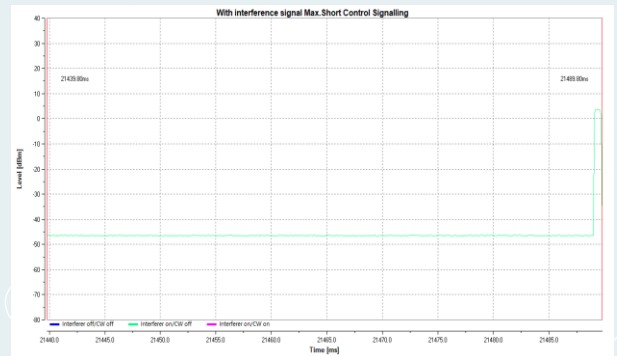

Lowest Frequency: 2412MHz

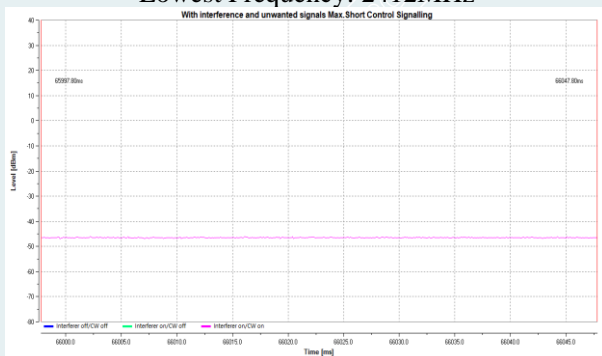

Lowest Frequency: 2412MHz

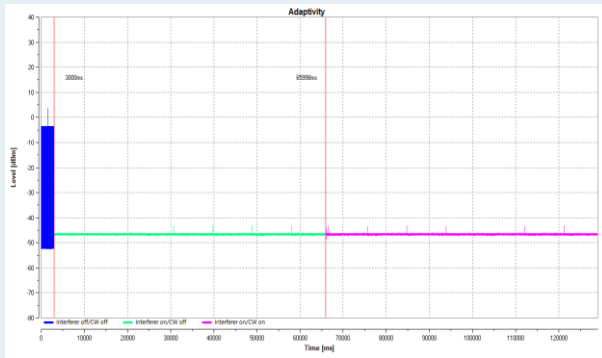

Highest Frequency: 2472MHz

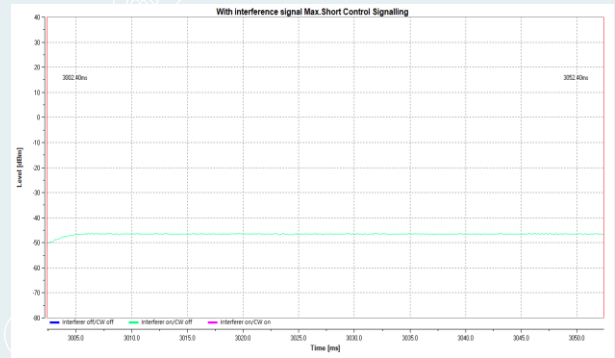

Highest Frequency: 2472MHz

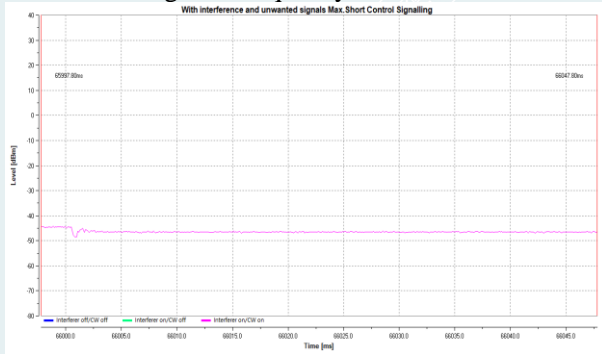

Highest Frequency: 2472MHz

802.11n40SISO

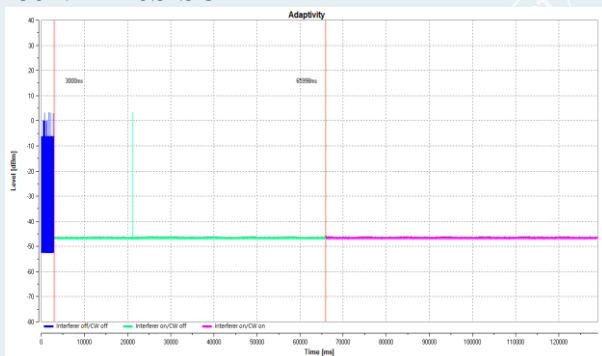

Lowest Frequency: 2422MHz

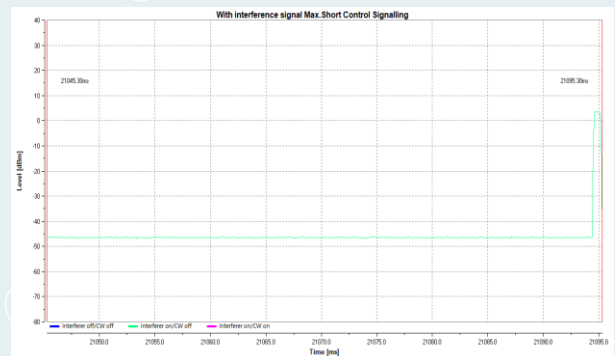

Lowest Frequency: 2422MHz

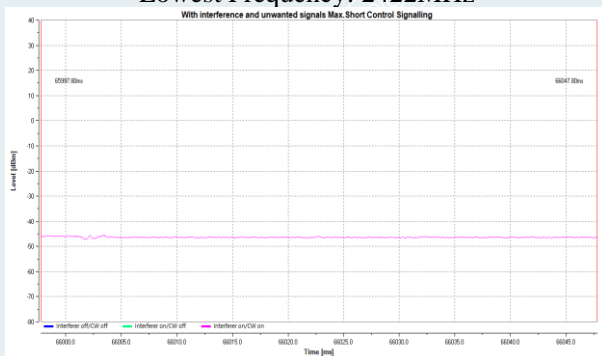

Lowest Frequency: 2422MHz

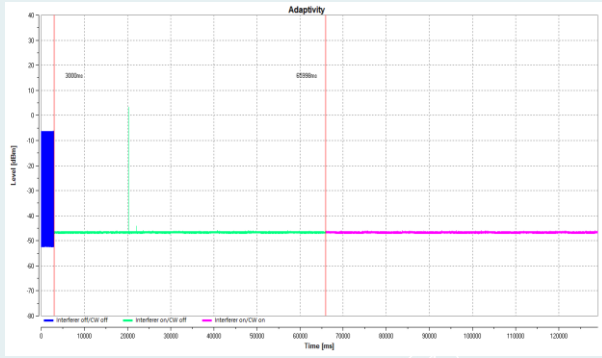

Highest Frequency: 2462MHz

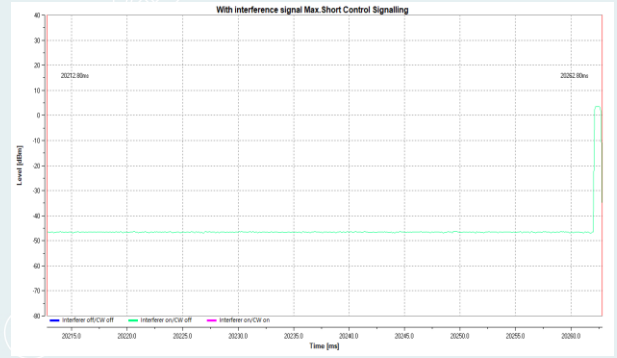

Highest Frequency: 2462MHz

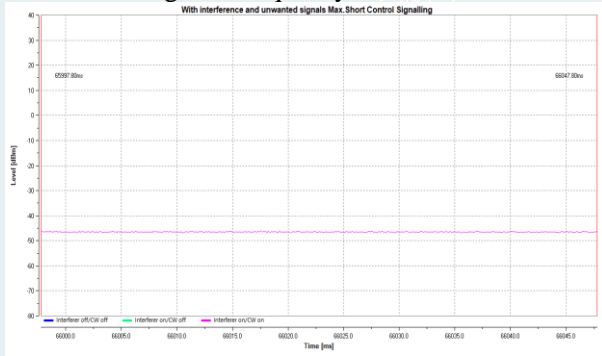

Highest Frequency: 2462MHz

## 5.4 OCCUPIED CHANNEL BANDWIDTH

Test Requirement: EN300 328 V2.2.2/ 4.3.2.7

Test Method: EN300 328 V2.2.2/5.4.7.2.1

### 5.4.1 LIMIT

This requirement applies to all types of non-FHSS equipment.

The Occupied Channel Bandwidth shall fall completely within the band given in table 2.

In addition, for non-adaptive equipment using wide band modulations other than FHSS and with e.i.r.p. greater than 10 dBm, the occupied channel bandwidth shall be less than 20 MHz.

Table 2: Service frequency bands

	Service frequency bands
Transmit	2 400 MHz to 2 483,5 MHz
Receive	2 400 MHz to 2 483,5 MHz

### 5.4.2 TEST CONFIGURATION

Conducted measurement:

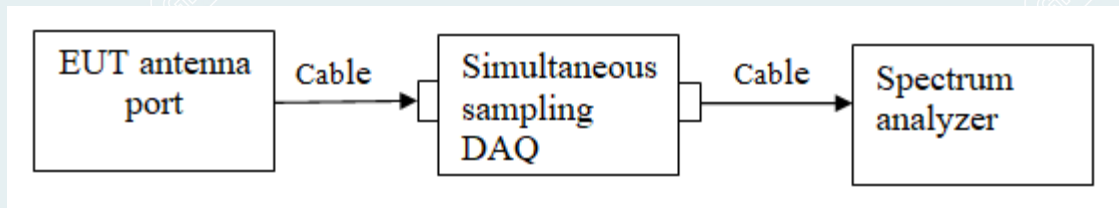

### 5.4.3 TEST PROCEDURES

Test condition: Normal test conditions.

Test channel: 2412MHz, 2442 MHz, 2472MHz for 802.11b/g/n HT20  
2422MHz, 2442MHz, 2462MHz for 802.11n HT40

Test procedure: Test procedure is according to Clause 5.4.7.2.1 of EN 300 328 V2.2.2

Remark: /

**5.4.4 TEST RESULTS**

Test Date (yy-mm-dd): 2021-06-14

Test environment: Normal condition:

Temp: 23.5°C, Humid:49%

TestMode	Antenna	Channel	OCB[MHz]	FL[MHz]	FH[MHz]	Limit[MHz]	Verdict
11b	Ant1	2412	14.999	2404.5545	2419.5535	2400 to 2483.5	PASS
		2442	14.974	2434.5804	2449.5544	2400 to 2483.5	PASS
		2472	14.993	2464.5191	2479.5121	2400 to 2483.5	PASS
11g	Ant1	2412	16.571	2403.7642	2420.3352	2400 to 2483.5	PASS
		2442	16.572	2433.7554	2450.3274	2400 to 2483.5	PASS
		2472	16.565	2463.7464	2480.3114	2400 to 2483.5	PASS
11n20SISO	Ant1	2412	17.695	2403.2036	2420.8986	2400 to 2483.5	PASS
		2442	17.703	2433.1995	2450.9025	2400 to 2483.5	PASS
		2472	17.697	2463.1834	2480.8804	2400 to 2483.5	PASS
11n40SISO	Ant1	2422	36.191	2403.9699	2440.1609	2400 to 2483.5	PASS
		2442	36.180	2423.9566	2460.1366	2400 to 2483.5	PASS
		2462	36.179	2443.9291	2480.1081	2400 to 2483.5	PASS

Test screenshots

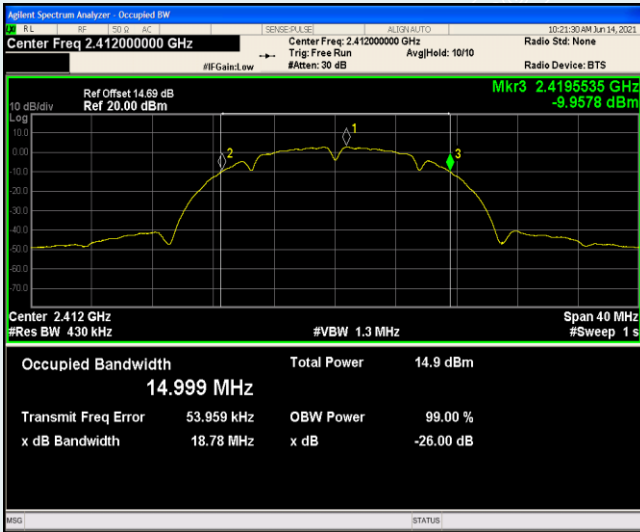

11b\_2412

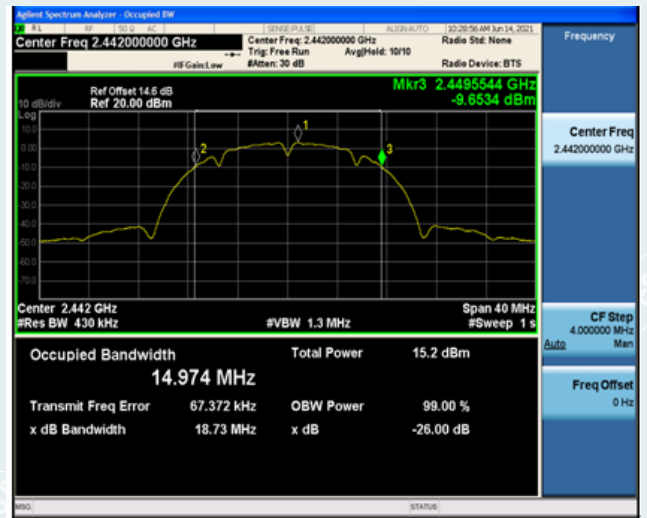

11b\_2442

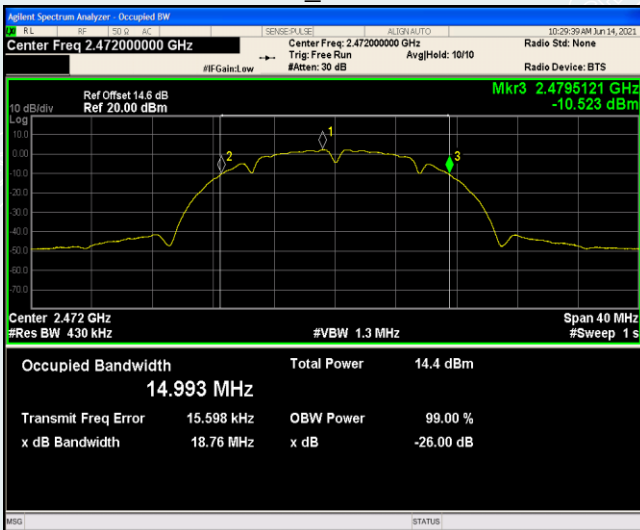

11b\_2472

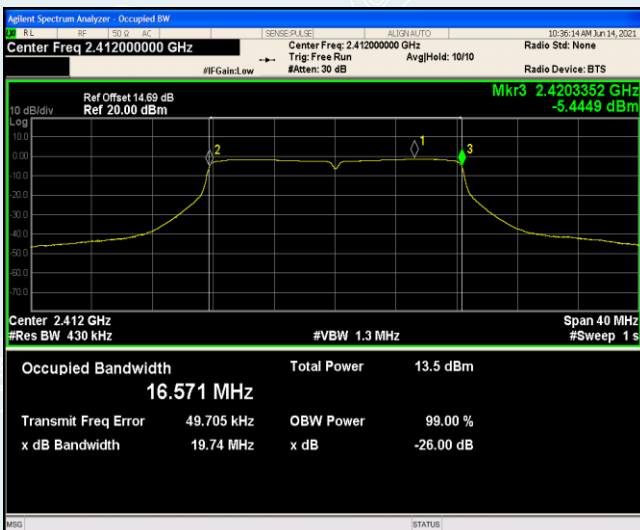

11g\_2412

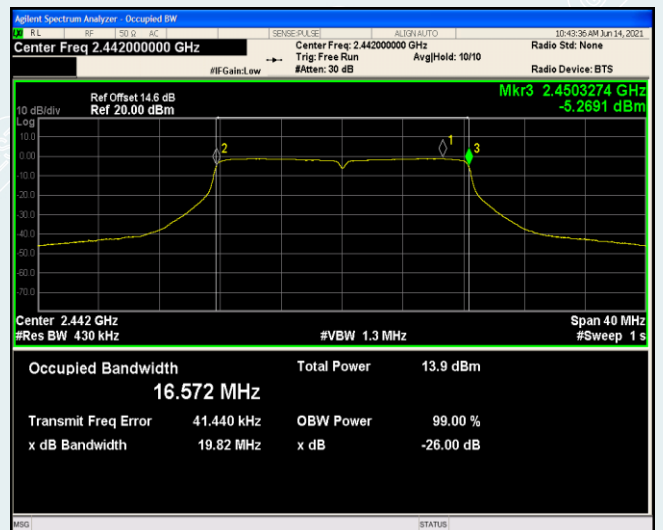

11g\_2442

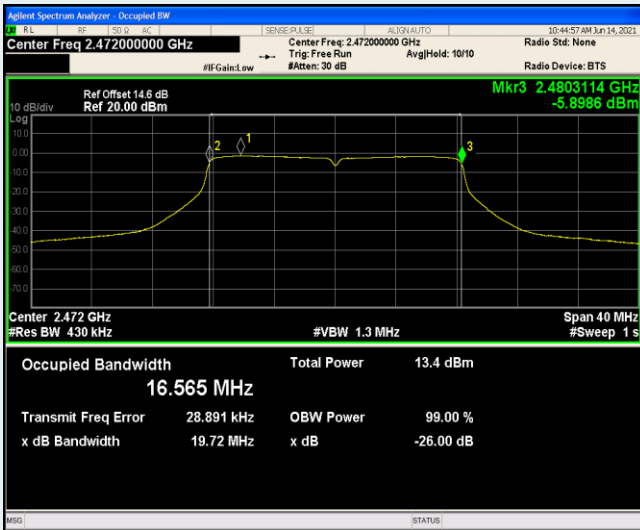

11g\_2472

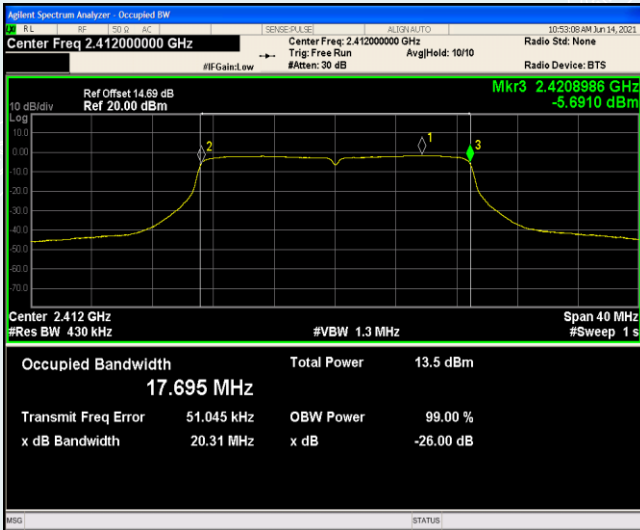

11n20\_2412

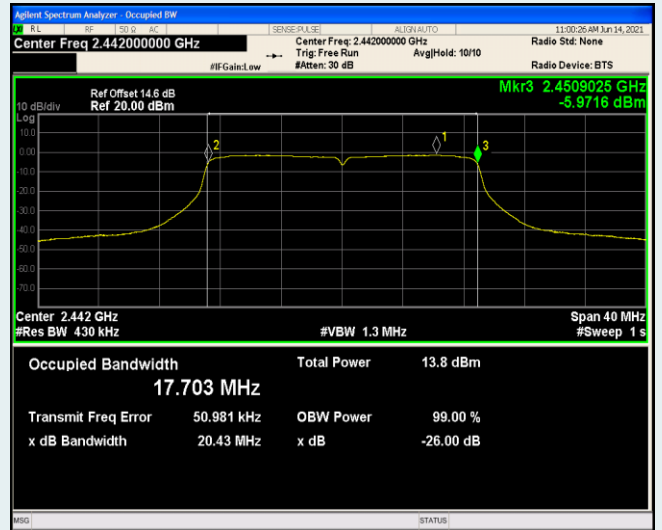

11n20\_2442

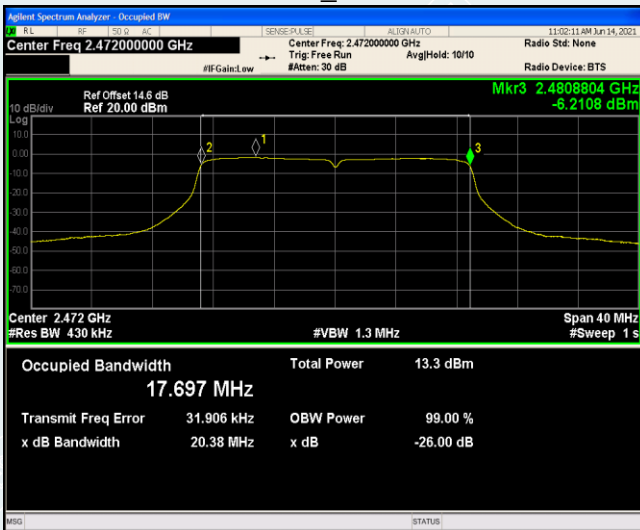

11n20\_2472



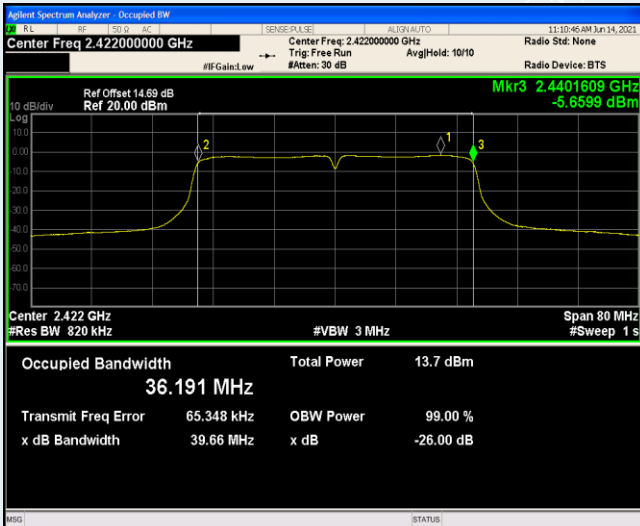

11n40\_2422

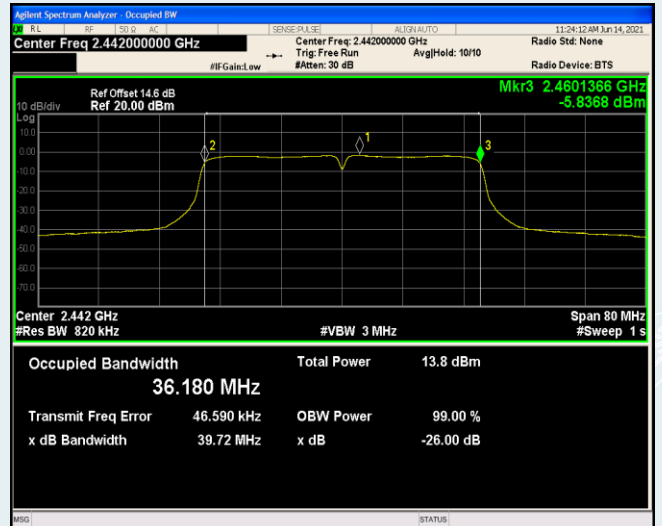

11n40\_2442

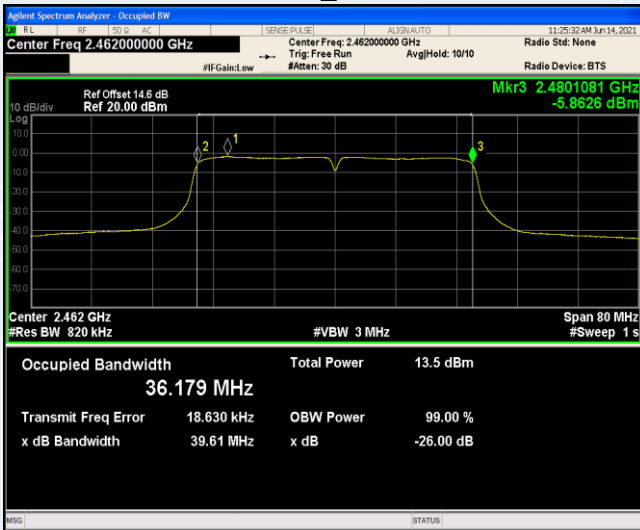

11n40\_2462

### 5.5 TRANSMITTER UNWANTED EMISSIONS IN THE OUT-OF-BAND DOMAIN

Test Requirement: EN300 328 V2.2.2/ 4.3.2.8

Test Method: EN300 328 V2.2.2/5.4.8.2.1

#### 5.5.1 LIMIT

This requirement applies to all types of FHSS equipment and all types of non-FHSS equipment.

The transmitter unwanted emissions in the out-of-band domain but outside the allocated band, shall not exceed the values provided by the mask in figure 3.

Within the band specified in table 3, the Out-of-band emissions are fulfilled by compliance with the Occupied Channel Bandwidth requirement in clause 6.10.1.1 and 6.10.1.2.

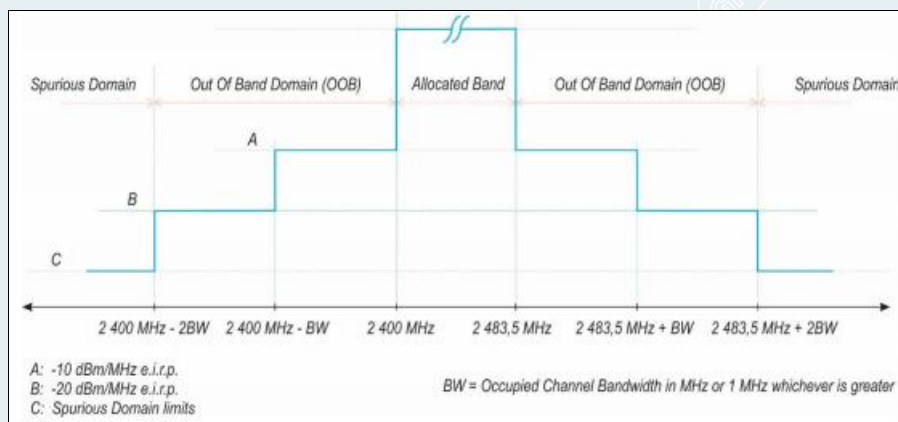

#### 5.5.2 TEST CONFIGURATION

Conducted measurement:

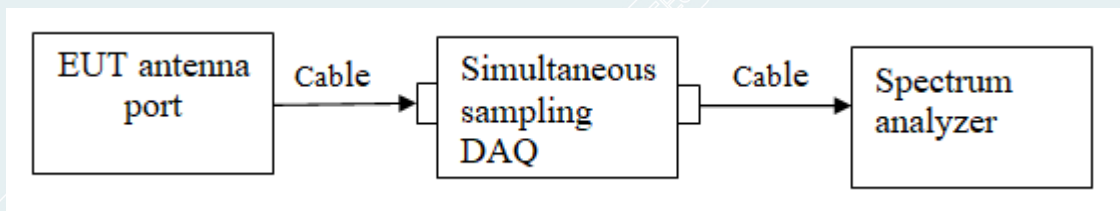

#### 5.5.3 TEST PROCEDURES

Test condition: Normal test conditions.

Test channel: 2412MHz, 2472MHz for 802.11b/g/n HT20

2422MHz, 2462MHz for 802.11n HT40

Test procedure: Test procedure is according to Clause 5.4.8.2.1 of EN 300 328 V2.2.2

Remark: /

### 5.5.4 Test Results

Test Date (yy-mm-dd): 2021-08-06

Test environment: Normal condition:

Temp: 23.4°C, Humid:49%

Type: 802.11b\_2412MHz

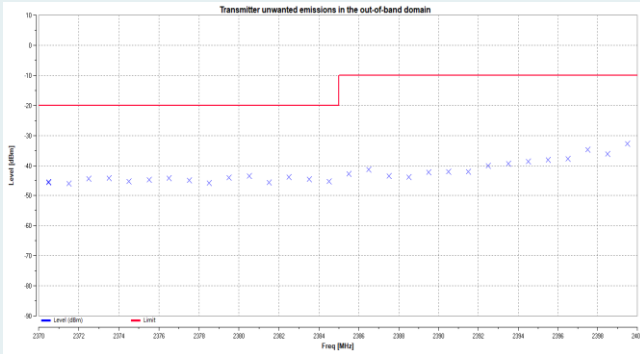

Left side of working frequency band

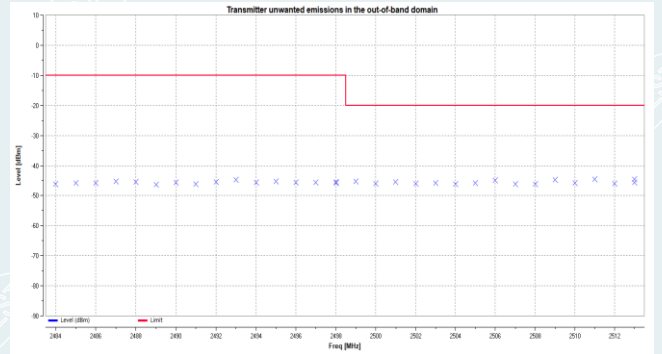

Right side of working frequency band

Type: 802.11b\_2472MHz

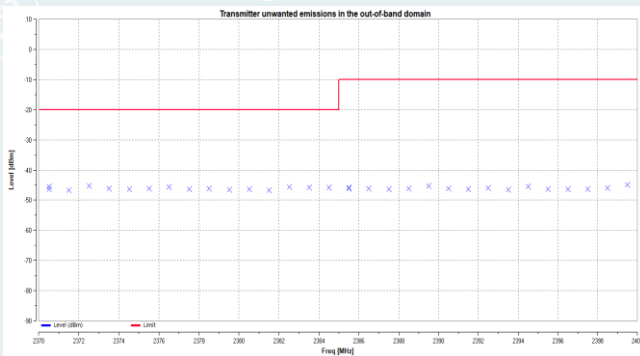

Left side of working frequency band

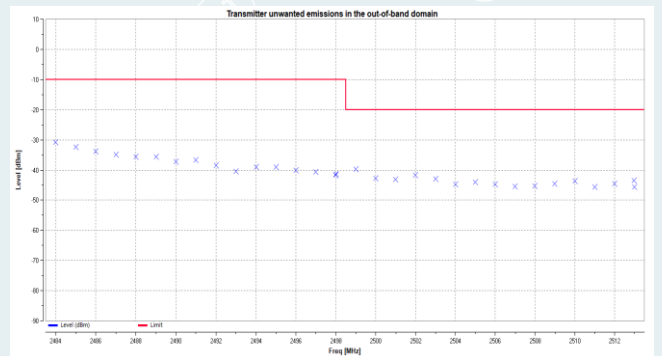

Right side of working frequency band

Type: 802.11g\_2412MHz

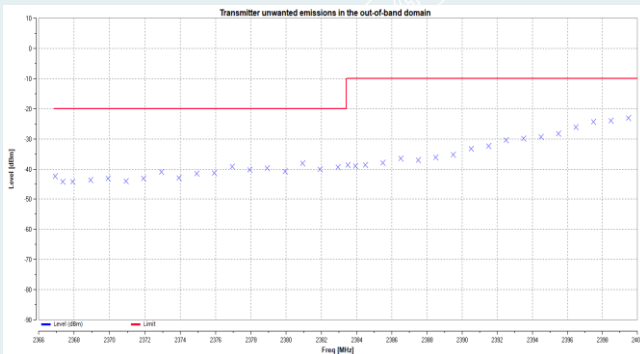

Left side of working frequency band

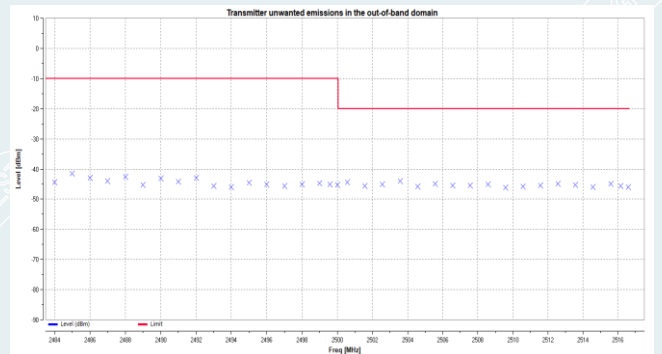

Right side of working frequency band

Type: 802.11g\_2472MHz

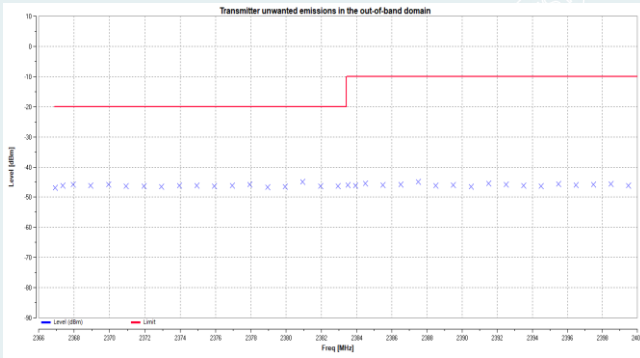

Left side of working frequency band

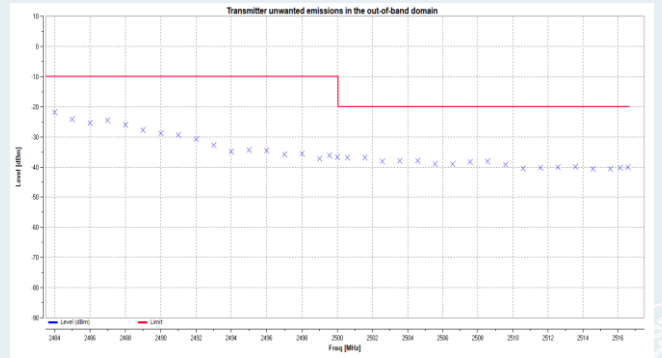

Right side of working frequency band

Type: 802.11n20\_2412MHz

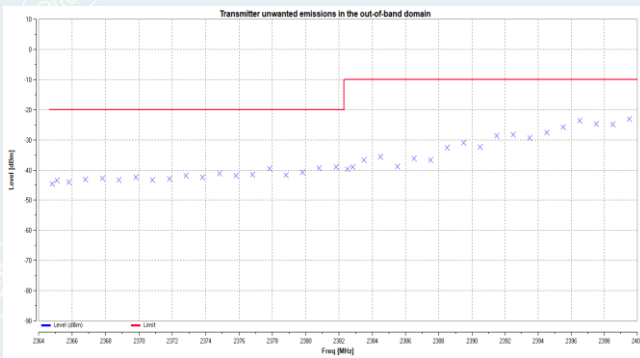

Left side of working frequency band

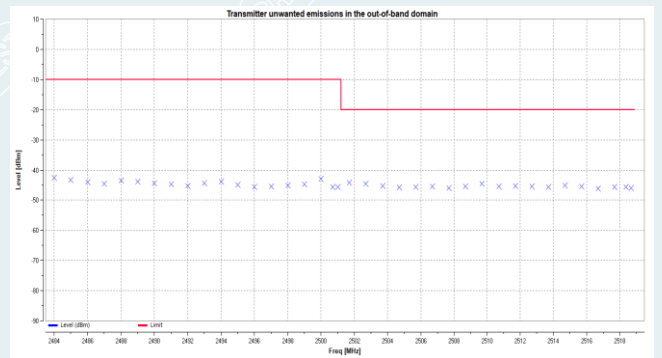

Right side of working frequency band

Type: 802.11n20\_2472MHz

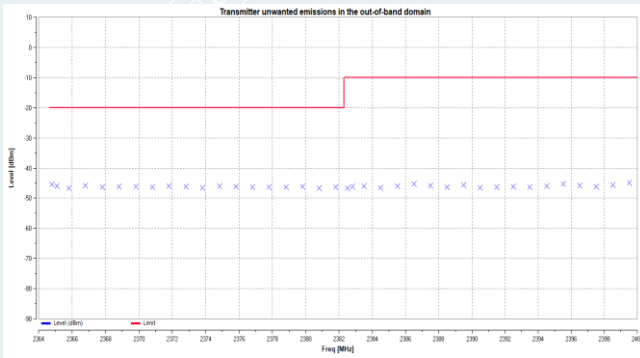

Left side of working frequency band

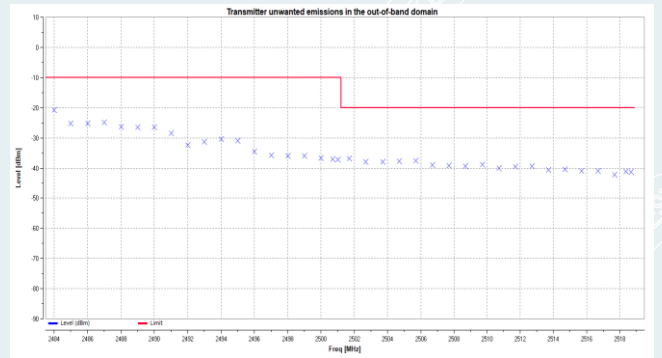

Right side of working frequency band

Type: 802.11n40\_2422MHz

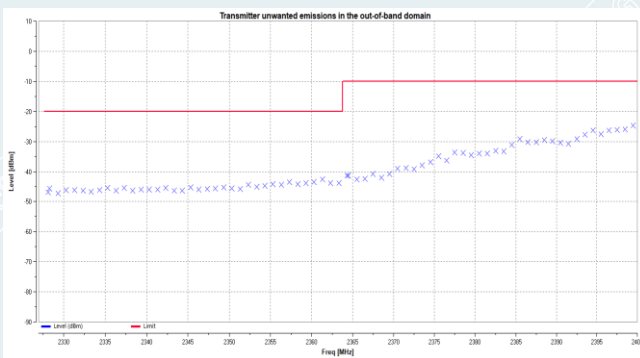

Left side of working frequency band

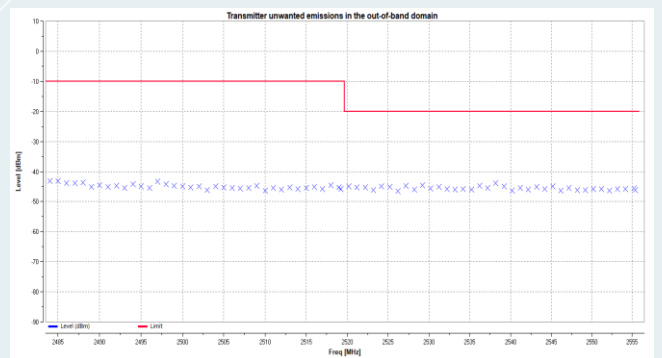

Right side of working frequency band

Type: 802.11n40\_2462MHz

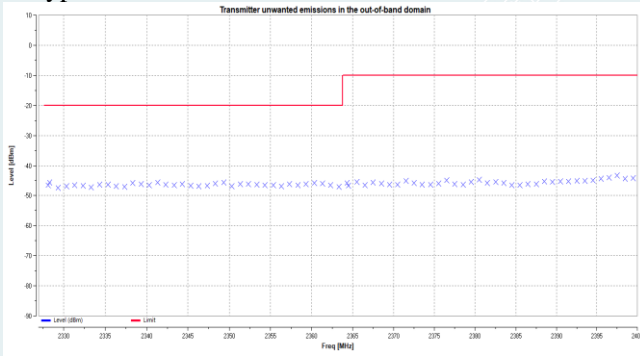

Left side of working frequency band

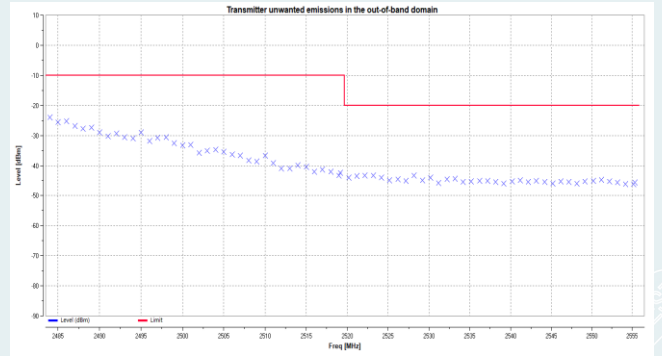

Right side of working frequency band

## 5.6 TRANSMITTER UNWANTED EMISSIONS IN THE SPURIOUS DOMAIN

Test Requirement: EN300 328 V2.2.2/ 4.3.2.9

Test Method: EN300 328 V2.2.2/5.4.9.2.2

### 5.6.1 LIMIT

This requirement applies to all types of FHSS equipment and all types of non-FHSS equipment.

The transmitter unwanted emissions in the spurious domain shall not exceed the values given in table 2. In case of equipment with antenna connectors, these limits apply to emissions at the antenna port (conducted). For emissions radiated by the cabinet or emissions radiated by integral antenna equipment (without antenna connectors), these limits are e.r.p. for emissions up to 1 GHz and as e.i.r.p. for emissions above 1 GHz.

Note: This test uses conducted emissions measurement and Radiated emissions measurement.

Table 2: Transmitter limits for spurious emissions

Frequency range	Maximum power	Bandwidth
30 MHz to 47 MHz	-36 dBm	100 kHz
47 MHz to 74 MHz	-54 dBm	100 kHz
74 MHz to 87,5 MHz	-36 dBm	100 kHz
87,5 MHz to 118 MHz	-54 dBm	100 kHz
118 MHz to 174 MHz	-36 dBm	100 kHz
174 MHz to 230 MHz	-54 dBm	100 kHz
230 MHz to 470 MHz	-36 dBm	100 kHz
470 MHz to 694 MHz	-54 dBm	100 kHz
694 MHz to 1 GHz	-36 dBm	100 kHz
1 GHz to 12,75 GHz	-30 dBm	1 MHz

### 5.6.2 TEST CONFIGURATION

#### (1) 30MHz~1000MHz

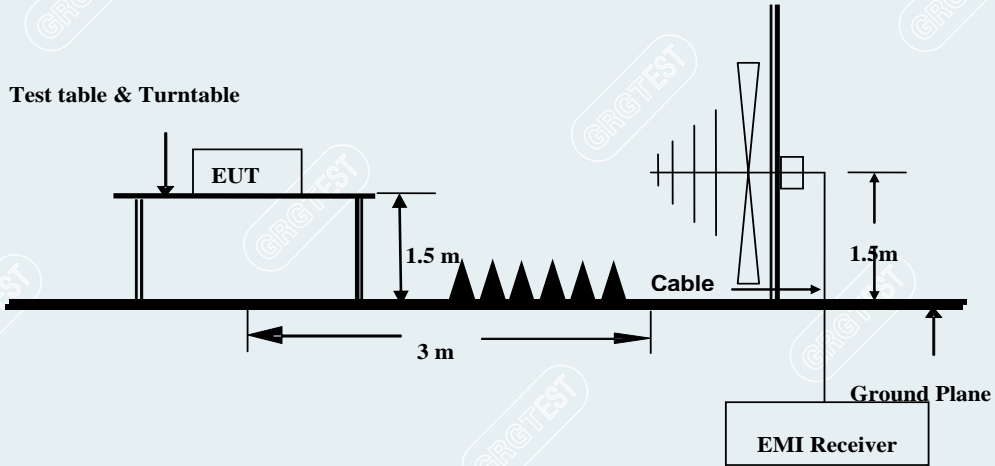
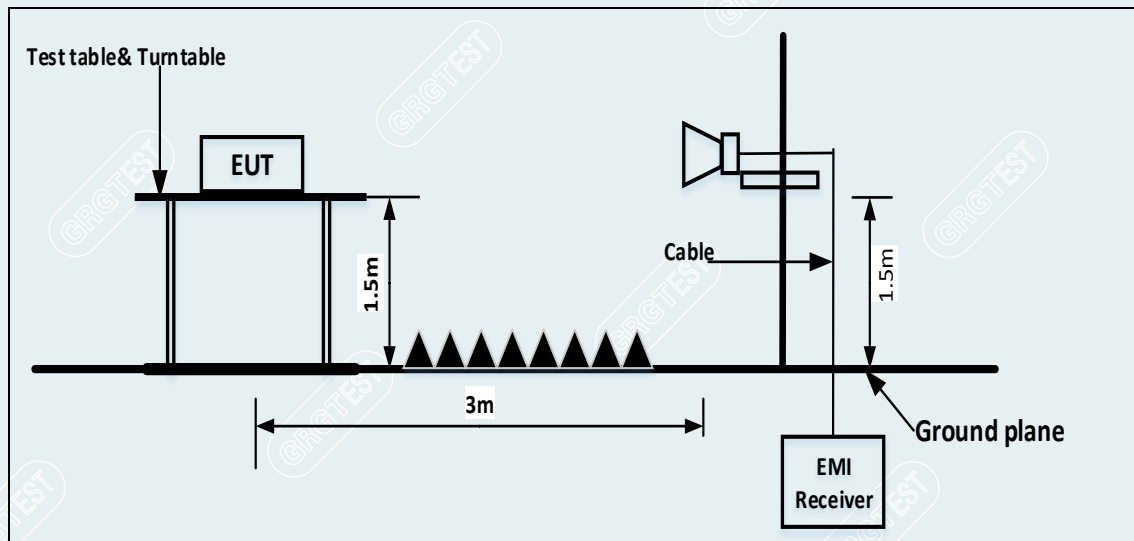

Figure 6.8-1: 30MHz-1000MHz measurement arrangement

#### (2) 1000MHz~12750MHz



### 5.6.3 TEST PROCEDURES

Test condition: Normal test conditions.

Test channel: 2412MHz, 2472MHz for 802.11b/g/n HT20  
2422MHz, 2462MHz for 802.11n HT40

Test procedure: Test procedure is according to Clause 5.4.9.2.1 of EN 300 328 V2.2.2

Remark: Pre-test all data rate and channel, found that 802.11b mode is the worst case, so only record the worst data.

**5.6.4 DATA SAMPLE**

Freq. [MHz]	Reading [dBm]	Level [dBm]	Limit [dBm]	Margin [dB]	Factor [dB/m]	Detector	Polarity
XXX	-49.71	-57.90	-30.00	27.90	-8.19	RMS	Horizontal

Frequency (MHz)	= Emission frequency in MHz
Reading (dBm)	= Uncorrected Analyzer / Receiver reading
Correct Factor (dB/m)	= Antenna factor + Cable loss – Amplifier gain
Result (dBm)	= Reading (dBm) + Corr. Factor (dB/m)
Limit (dBm)	= Limit stated in standard
Margin (dB)	= Result (dBm) – Limit(dBm)
RMS	= Root Mean Square



### 5.6.5 TEST RESULTS

Below 1GHz

Recorded the worst case results in this report (IEEE 802.11b)

Adapter 1:

Project No	E20210426746801	EUT:	Camera Hub G3
Model:	CH-H03	Sample No:	E20210426746801-0008
Mode:	TX 802.11b 2412MHz	Voltage:	AC230V/50Hz
Environment:	Temp:24.5°C ;Humi:59%	Engineer:	Chen Xiacong

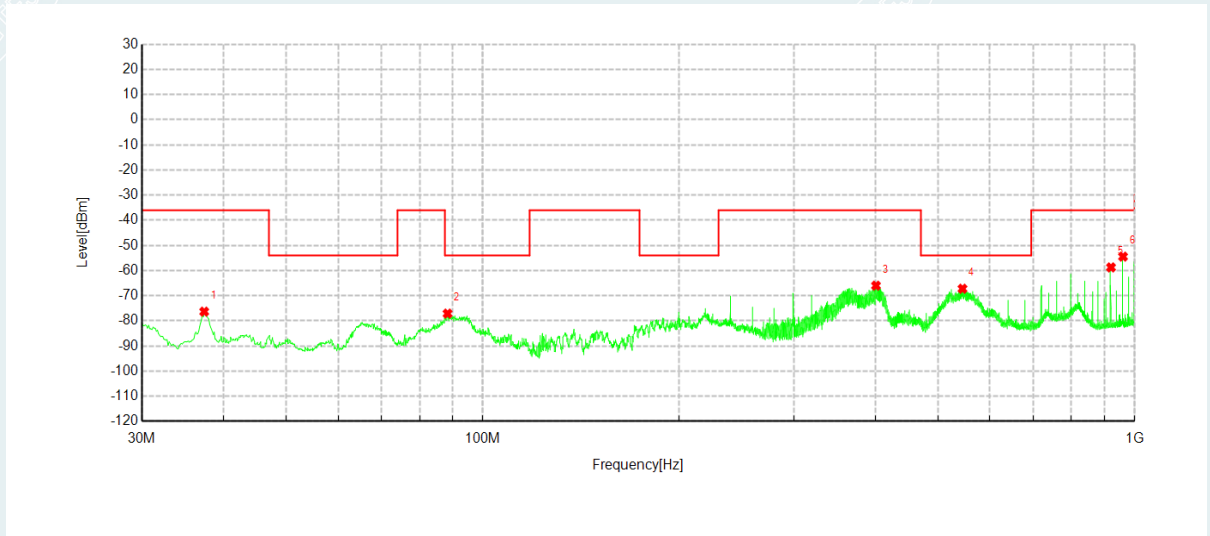

Suspected Data List								
NO.	Freq. [MHz]	Reading [dBm]	Level [dBm]	Limit [dBm]	Margin [dB]	Factor [dB]	Detector	Polarity
1	37.3963	-63.93	-76.34	-36.00	40.34	-12.41	RMS	Horizontal
2	88.3213	-52.97	-77.12	-54.00	23.12	-24.15	RMS	Horizontal
3	401.1463	-53.50	-66.01	-36.00	30.01	-12.51	RMS	Horizontal
4	544.4638	-57.17	-67.23	-54.00	13.23	-10.06	RMS	Horizontal
5	919.9750	-53.83	-58.74	-36.00	22.74	-4.91	RMS	Horizontal
6	959.9875	-50.19	-54.46	-36.00	18.46	-4.27	RMS	Horizontal

Project No	E20210426746801	EUT:	Camera Hub G3
Model:	CH-H03	Sample No:	E20210426746801-0008
Mode:	TX 802.11b 2412MHz	Voltage:	AC230V/50Hz
Environment:	Temp:24.5℃;Humi:59%	Engineer:	Chen Xiacong

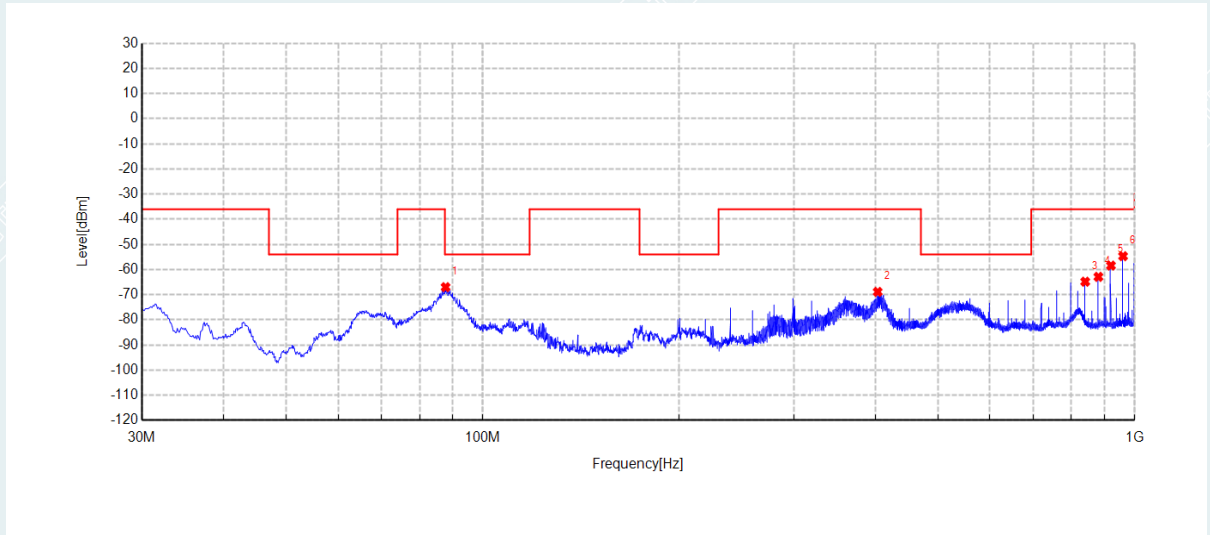

Suspected Data List								
NO.	Freq. [MHz]	Reading [dBm]	Level [dBm]	Limit [dBm]	Margin [dB]	Factor [dB]	Detector	Polarity
1	87.7150	-48.33	-67.00	-54.00	13.00	-18.67	RMS	Vertical
2	403.5713	-55.92	-68.88	-36.00	32.88	-12.96	RMS	Vertical
3	839.9500	-58.63	-64.83	-36.00	28.83	-6.20	RMS	Vertical
4	879.9625	-57.71	-62.90	-36.00	26.90	-5.19	RMS	Vertical
5	919.9750	-53.52	-58.42	-36.00	22.42	-4.90	RMS	Vertical
6	959.9875	-50.00	-54.68	-36.00	18.68	-4.68	RMS	Vertical

Project No	E20210426746801	EUT:	Camera Hub G3
Model:	CH-H03	Sample No:	E20210426746801-0008
Mode:	TX 802.11b 2472MHz	Voltage:	AC230V/50Hz
Environment:	Temp:24.5℃;Humi:59%	Engineer:	Chen Xiacong

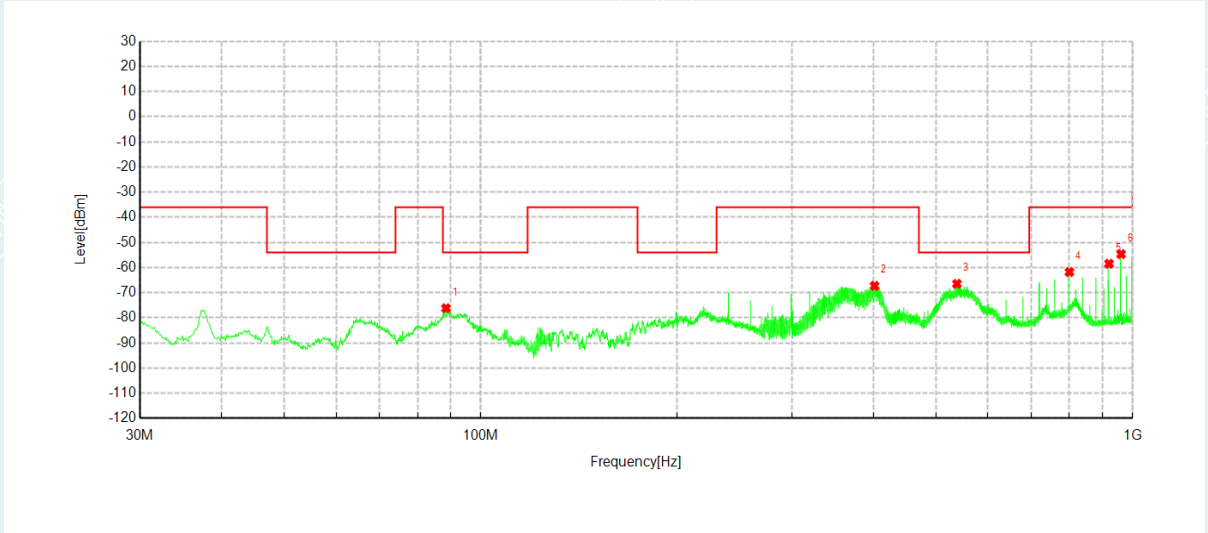

**Suspected Data List**

NO.	Freq. [MHz]	Reading [dBm]	Level [dBm]	Limit [dBm]	Margin [dB]	Factor [dB]	Detector	Polarity
1	88.4425	-52.04	-76.18	-54.00	22.18	-24.14	RMS	Horizontal
2	401.8738	-54.81	-67.28	-36.00	31.28	-12.47	RMS	Horizontal
3	537.6738	-56.21	-66.48	-54.00	12.48	-10.27	RMS	Horizontal
4	799.9375	-56.14	-61.79	-36.00	25.79	-5.65	RMS	Horizontal
5	919.9750	-53.57	-58.48	-36.00	22.48	-4.91	RMS	Horizontal
6	959.9875	-50.39	-54.66	-36.00	18.66	-4.27	RMS	Horizontal

Project No	E20210426746801	EUT:	Camera Hub G3
Model:	CH-H03	Sample No:	E20210426746801-0008
Mode:	TX 802.11b 2472MHz	Voltage:	AC230V/50Hz
Environment:	Temp:24.5℃;Humi:59%	Engineer:	Chen Xiacong

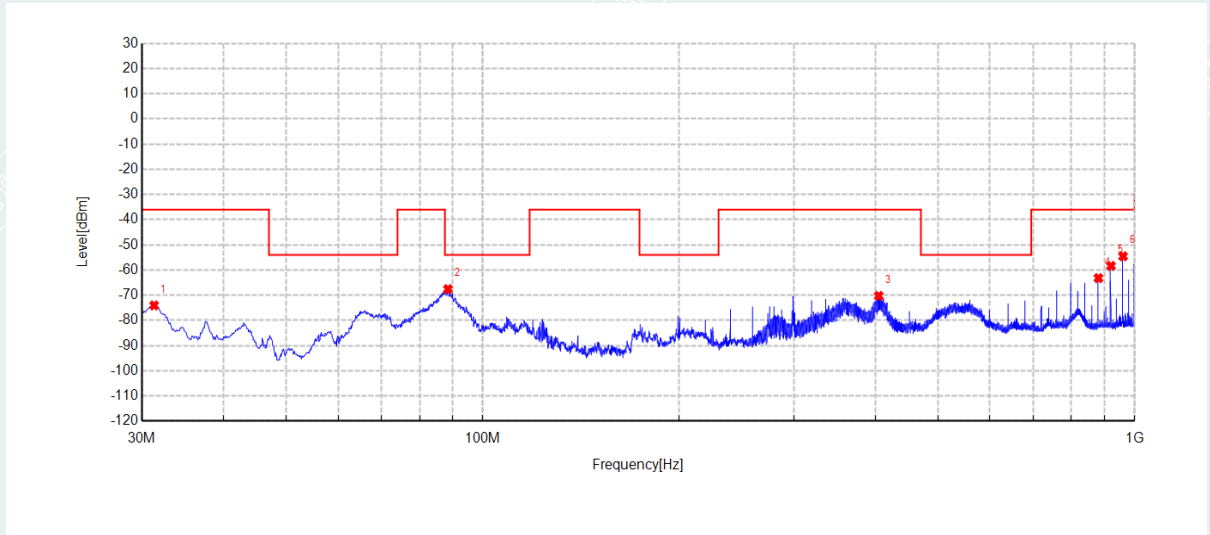

Suspected Data List								
NO.	Freq. [MHz]	Reading [dBm]	Level [dBm]	Limit [dBm]	Margin [dB]	Factor [dB]	Detector	Polarity
1	31.3338	-50.35	-74.04	-36.00	38.04	-23.69	RMS	Vertical
2	88.4425	-49.42	-67.58	-54.00	13.58	-18.16	RMS	Vertical
3	405.0263	-57.36	-70.26	-36.00	34.26	-12.90	RMS	Vertical
4	879.9625	-58.01	-63.20	-36.00	27.20	-5.19	RMS	Vertical
5	919.9750	-53.46	-58.36	-36.00	22.36	-4.90	RMS	Vertical
6	959.9875	-49.86	-54.54	-36.00	18.54	-4.68	RMS	Vertical

Adapter 2:

Project No	E20210426746801	EUT:	Camera Hub G3
Model:	CH-H03	Sample No:	E20210426746801-0008
Mode:	TX 802.11b 2412MHz	Voltage:	AC230V/50Hz
Environment:	Temp:24.8°C;Humi:52%	Engineer:	Chen Xiacong

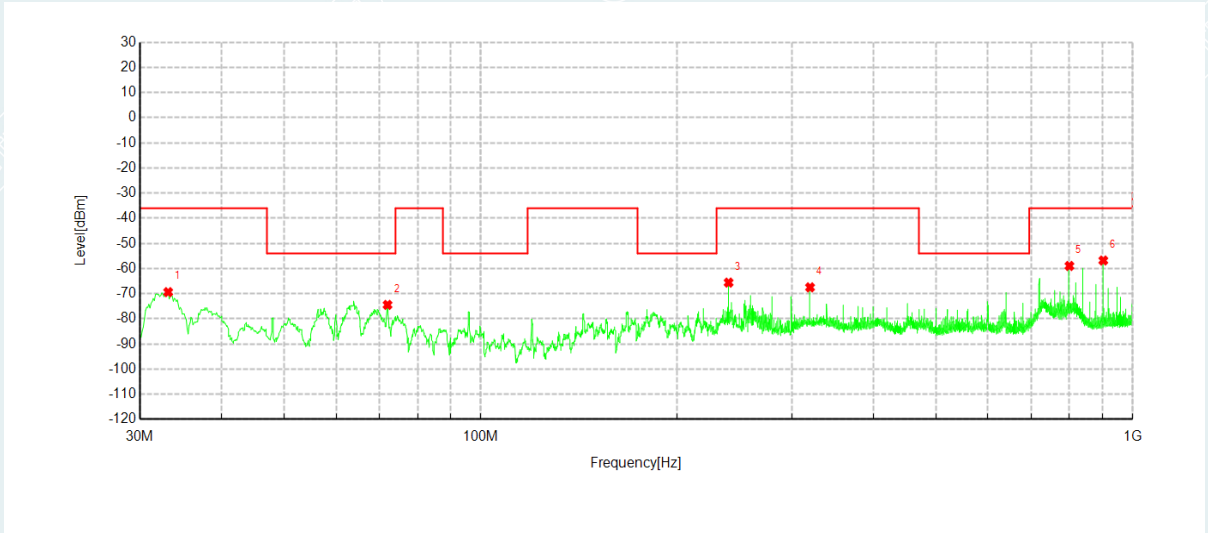

Suspected Data List								
NO.	Freq. [MHz]	Reading [dBm]	Level [dBm]	Limit [dBm]	Margin [dB]	Factor [dB]	Detector	Polarity
1	33.1525	-55.51	-69.37	-36.00	33.37	-13.86	RMS	Horizontal
2	71.9525	-52.47	-74.44	-54.00	20.44	-21.97	RMS	Horizontal
3	240.0050	-51.63	-65.59	-36.00	29.59	-13.96	RMS	Horizontal
4	320.0300	-51.09	-67.48	-36.00	31.48	-16.39	RMS	Horizontal
5	799.9375	-53.32	-58.97	-36.00	22.97	-5.65	RMS	Horizontal
6	901.6663	-51.46	-56.79	-36.00	20.79	-5.33	RMS	Horizontal

Project No	E20210426746801	EUT:	Camera Hub G3
Model:	CH-H03	Sample No:	E20210426746801-0008
Mode:	TX 802.11b 2412MHz	Voltage:	AC230V/50Hz
Environment:	Temp:24.8°C ;Humi:52%	Engineer:	Chen Xiacong

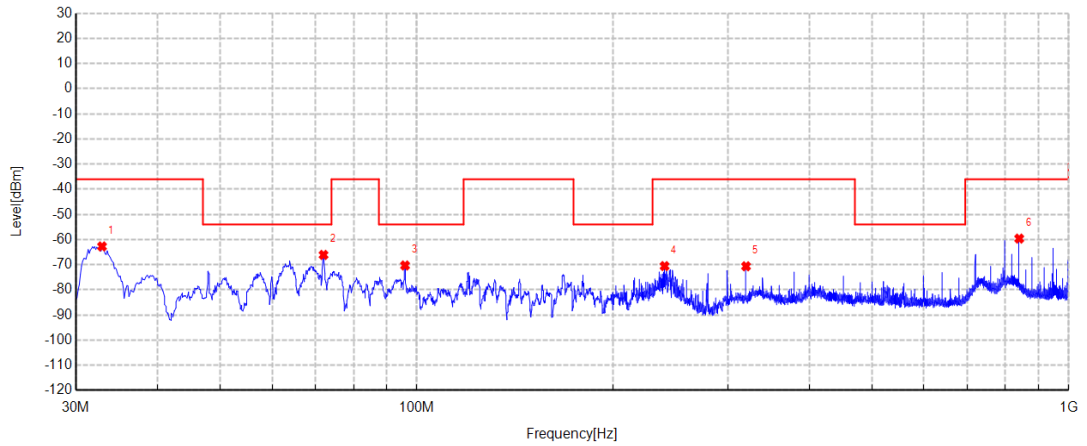

**Suspected Data List**

NO.	Freq. [MHz]	Reading [dBm]	Level [dBm]	Limit [dBm]	Margin [dB]	Factor [dB]	Detector	Polarity
1	32.9100	-39.78	-62.74	-36.00	26.74	-22.96	RMS	Vertical
2	71.9525	-43.27	-66.11	-54.00	12.11	-22.84	RMS	Vertical
3	95.9600	-54.56	-70.31	-54.00	16.31	-15.75	RMS	Vertical
4	240.0050	-51.09	-70.56	-36.00	34.56	-19.47	RMS	Vertical
5	320.0300	-55.84	-70.63	-36.00	34.63	-14.79	RMS	Vertical
6	839.9500	-53.42	-59.62	-36.00	23.62	-6.20	RMS	Vertical

Project No	E20210426746801	EUT:	Camera Hub G3
Model:	CH-H03	Sample No:	E20210426746801-0008
Mode:	TX 802.11b 2472MHz	Voltage:	AC230V/50Hz
Environment:	Temp:24.8°C;Humi:52%	Engineer:	Chen Xiacong

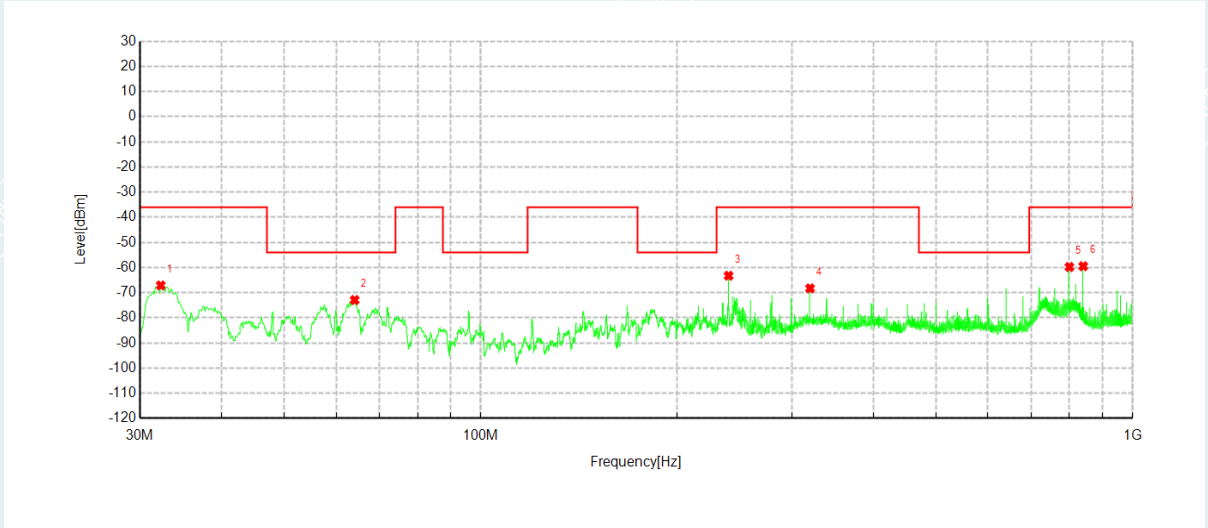

Suspected Data List								
NO.	Freq. [MHz]	Reading [dBm]	Level [dBm]	Limit [dBm]	Margin [dB]	Factor [dB]	Detector	Polarity
1	32.3038	-52.96	-67.11	-36.00	31.11	-14.15	RMS	Horizontal
2	64.0713	-54.81	-72.92	-54.00	18.92	-18.11	RMS	Horizontal
3	240.0050	-49.30	-63.26	-36.00	27.26	-13.96	RMS	Horizontal
4	320.0300	-51.90	-68.29	-36.00	32.29	-16.39	RMS	Horizontal
5	799.9375	-54.13	-59.78	-36.00	23.78	-5.65	RMS	Horizontal
6	839.9500	-53.34	-59.47	-36.00	23.47	-6.13	RMS	Horizontal

Project No	E20210426746801	EUT:	Camera Hub G3
Model:	CH-H03	Sample No:	E20210426746801-0008
Mode:	TX 802.11b 2472MHz	Voltage:	AC230V/50Hz
Environment:	Temp:24.8℃;Humi:52%	Engineer:	Chen Xiacong

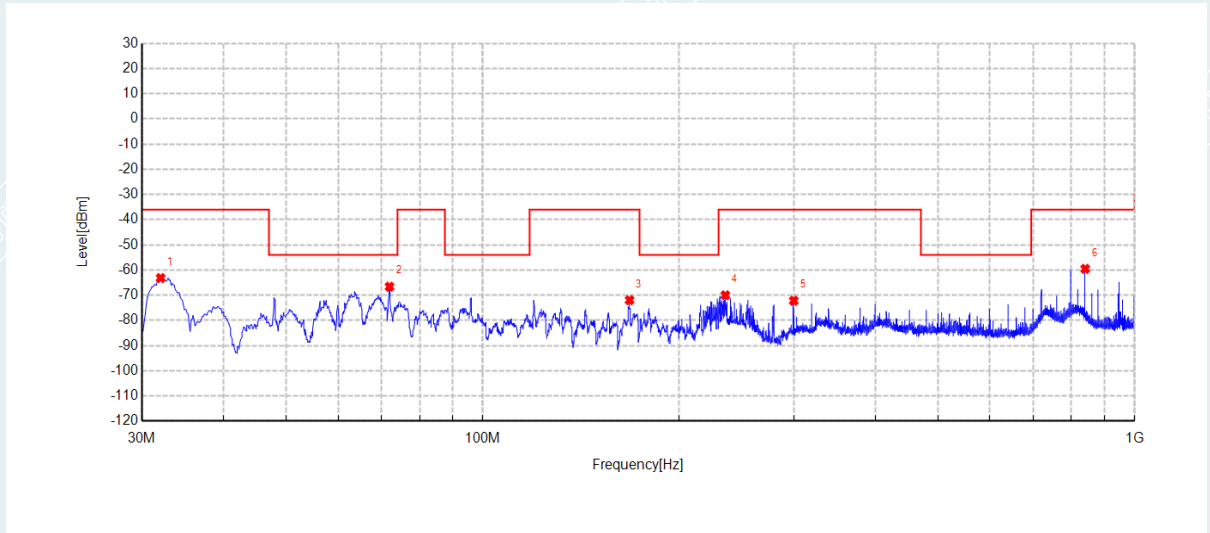

Suspected Data List								
NO.	Freq. [MHz]	Reading [dBm]	Level [dBm]	Limit [dBm]	Margin [dB]	Factor [dB]	Detector	Polarity
1	32.0613	-39.80	-63.15	-36.00	27.15	-23.35	RMS	Vertical
2	71.9525	-43.75	-66.59	-54.00	12.59	-22.84	RMS	Vertical
3	167.9825	-50.09	-71.95	-36.00	35.95	-21.86	RMS	Vertical
4	235.6400	-50.41	-70.01	-36.00	34.01	-19.60	RMS	Vertical
5	300.0238	-56.65	-72.17	-36.00	36.17	-15.52	RMS	Vertical
6	839.9500	-53.32	-59.52	-36.00	23.52	-6.20	RMS	Vertical



Above 1GHz

Adapter 1:

Project No	E20210426746801	EUT:	Camera Hub G3
Model:	CH-H03	Sample No:	E20210426746801-0008
Mode:	TX 802.11b 2412MHz	Voltage:	AC230V/50Hz
Environment:	Temp:24.5℃;Humi:59%	Engineer:	Chen Xiacong

**Suspected Data List**

NO.	Freq. [MHz]	Reading [dBm]	Level [dBm]	Limit [dBm]	Margin [dB]	Factor [dB]	Detector	Polarity
1	1399.100	-39.74	-51.69	-30.00	21.69	-11.95	RMS	Horizontal
2	1595.400	-44.09	-57.75	-30.00	27.75	-13.66	RMS	Horizontal
3	2413.600	-31.56	-40.32	-30.00	10.32	-8.76	RMS	Horizontal
4	4806.675	-50.95	-49.04	-30.00	19.04	1.91	RMS	Horizontal
5	6432.000	-58.69	-54.98	-30.00	24.98	3.71	RMS	Horizontal
6	8804.175	-67.84	-54.44	-30.00	24.44	13.40	RMS	Horizontal

**Suspected Data List**

NO.	Freq. [MHz]	Reading [dBm]	Level [dBm]	Limit [dBm]	Margin [dB]	Factor [dB]	Detector	Polarity
1	1390.000	-47.48	-59.72	-30.00	29.72	-12.24	RMS	Vertical
2	1596.500	-45.78	-59.22	-30.00	29.22	-13.44	RMS	Vertical
3	2414.300	-34.89	-43.38	-30.00	13.38	-8.49	RMS	Vertical
4	2596.700	-47.08	-56.20	-30.00	26.20	-9.12	RMS	Vertical
5	4806.675	-52.63	-50.65	-30.00	20.65	1.98	RMS	Vertical
6	6432.000	-56.43	-52.43	-30.00	22.43	4.00	RMS	Vertical

Project No	E20210426746801	EUT:	Camera Hub G3
Model:	CH-H03	Sample No:	E20210426746801-0008
Mode:	TX 802.11b 2472MHz	Voltage:	AC230V/50Hz
Environment:	Temp:24.5°C;Humi:59%	Engineer:	Chen Xiacong

**Suspected Data List**

NO.	Freq. [MHz]	Reading [dBm]	Level [dBm]	Limit [dBm]	Margin [dB]	Factor [dB]	Detector	Polarity
1	1592.800	-43.02	-56.72	-30.00	26.72	-13.70	RMS	Horizontal
2	1995.900	-54.14	-61.91	-30.00	31.91	-7.77	RMS	Horizontal
3	2473.300	-27.95	-36.96	-30.00	6.96	-9.01	RMS	Horizontal
4	4806.675	-50.79	-48.88	-30.00	18.88	1.91	RMS	Horizontal
5	4944.150	-52.13	-50.38	-30.00	20.38	1.75	RMS	Horizontal
6	6591.900	-57.86	-53.18	-30.00	23.18	4.68	RMS	Horizontal

**Suspected Data List**

NO.	Freq. [MHz]	Reading [dBm]	Level [dBm]	Limit [dBm]	Margin [dB]	Factor [dB]	Detector	Polarity
1	1596.600	-42.58	-56.02	-30.00	26.02	-13.44	RMS	Vertical
2	2471.100	-32.09	-41.14	-30.00	11.14	-9.05	RMS	Vertical
3	4806.675	-52.49	-50.51	-30.00	20.51	1.98	RMS	Vertical
4	4944.150	-54.57	-52.82	-30.00	22.82	1.75	RMS	Vertical
5	6591.900	-60.01	-55.73	-30.00	25.73	4.28	RMS	Vertical

Project No	E20210426746801	EUT:	Camera Hub G3
Model:	CH-H03	Sample No:	E20210426746801-0008
Mode:	TX 802.11g 2412MHz	Voltage:	AC230V/50Hz
Environment:	Temp:24.5℃;Humi:59%	Engineer:	Chen Xiacong

**Suspected Data List**

NO.	Freq. [MHz]	Reading [dBm]	Level [dBm]	Limit [dBm]	Margin [dB]	Factor [dB]	Detector	Polarity
1	1598.900	-39.03	-52.64	-30.00	22.64	-13.61	RMS	Horizontal
2	1920.100	-52.90	-60.53	-30.00	30.53	-7.63	RMS	Horizontal
3	2417.400	-33.48	-42.23	-30.00	12.23	-8.75	RMS	Horizontal
4	4806.675	-51.09	-49.18	-30.00	19.18	1.91	RMS	Horizontal
5	6432.000	-58.32	-54.61	-30.00	24.61	3.71	RMS	Horizontal
6	8076.825	-67.12	-56.98	-30.00	26.98	10.14	RMS	Horizontal

**Suspected Data List**

NO.	Freq. [MHz]	Reading [dBm]	Level [dBm]	Limit [dBm]	Margin [dB]	Factor [dB]	Detector	Polarity
1	1378.100	-39.93	-52.81	-30.00	22.81	-12.88	RMS	Vertical
2	1593.600	-38.86	-52.37	-30.00	22.37	-13.51	RMS	Vertical
3	2416.900	-36.00	-44.51	-30.00	14.51	-8.51	RMS	Vertical
4	3199.875	-55.01	-60.50	-30.00	30.50	-5.49	RMS	Vertical
5	4806.675	-52.56	-50.58	-30.00	20.58	1.98	RMS	Vertical
6	6432.000	-55.99	-51.99	-30.00	21.99	4.00	RMS	Vertical

Project No	E20210426746801	EUT:	Camera Hub G3
Model:	CH-H03	Sample No:	E20210426746801-0008
Mode:	TX 802.11g 2472MHz	Voltage:	AC230V/50Hz
Environment:	Temp:24.5°C;Humi:59%	Engineer:	Chen Xiacong

**Suspected Data List**

NO.	Freq. [MHz]	Reading [dBm]	Level [dBm]	Limit [dBm]	Margin [dB]	Factor [dB]	Detector	Polarity
1	1599.300	-42.27	-55.87	-30.00	25.87	-13.60	RMS	Horizontal
2	2475.000	-34.56	-43.60	-30.00	13.60	-9.04	RMS	Horizontal
3	4806.675	-50.99	-49.08	-30.00	19.08	1.91	RMS	Horizontal
4	4945.125	-59.50	-57.74	-30.00	27.74	1.76	RMS	Horizontal
5	6591.900	-57.62	-52.94	-30.00	22.94	4.68	RMS	Horizontal
6	10798.05	-70.21	-53.22	-30.00	23.22	16.99	RMS	Horizontal

**Suspected Data List**

NO.	Freq. [MHz]	Reading [dBm]	Level [dBm]	Limit [dBm]	Margin [dB]	Factor [dB]	Detector	Polarity
1	1055.800	-45.25	-60.24	-30.00	30.24	-14.99	RMS	Vertical
2	1597.100	-39.82	-53.25	-30.00	23.25	-13.43	RMS	Vertical
3	2470.900	-33.69	-42.73	-30.00	12.73	-9.04	RMS	Vertical
4	4806.675	-52.60	-50.62	-30.00	20.62	1.98	RMS	Vertical
5	6591.900	-59.61	-55.33	-30.00	25.33	4.28	RMS	Vertical
6	7237.350	-65.40	-55.93	-30.00	25.93	9.47	RMS	Vertical

Project No	E20210426746801	EUT:	Camera Hub G3
Model:	CH-H03	Sample No:	E20210426746801-0008
Mode:	TX 802.11n20 2412MHz	Voltage:	AC230V/50Hz
Environment:	Temp:24.5°C;Humi:59%	Engineer:	Chen Xiacong

**Suspected Data List**

NO.	Freq. [MHz]	Reading [dBm]	Level [dBm]	Limit [dBm]	Margin [dB]	Factor [dB]	Detector	Polarity
1	1597.700	-42.44	-56.07	-30.00	26.07	-13.63	RMS	Horizontal
2	2418.500	-36.28	-45.03	-30.00	15.03	-8.75	RMS	Horizontal
3	3199.875	-59.41	-64.95	-30.00	34.95	-5.54	RMS	Horizontal
4	4806.675	-50.93	-49.02	-30.00	19.02	1.91	RMS	Horizontal
5	6432.000	-58.61	-54.90	-30.00	24.90	3.71	RMS	Horizontal
6	10796.10	-70.17	-53.29	-30.00	23.29	16.88	RMS	Horizontal

**Suspected Data List**

NO.	Freq. [MHz]	Reading [dBm]	Level [dBm]	Limit [dBm]	Margin [dB]	Factor [dB]	Detector	Polarity
1	1596.700	-39.54	-52.97	-30.00	22.97	-13.43	RMS	Vertical
2	2418.300	-34.15	-42.66	-30.00	12.66	-8.51	RMS	Vertical
3	3595.725	-60.88	-62.51	-30.00	32.51	-1.63	RMS	Vertical
4	4806.675	-52.59	-50.61	-30.00	20.61	1.98	RMS	Vertical
5	6432.000	-55.73	-51.73	-30.00	21.73	4.00	RMS	Vertical
6	10800.00	-70.39	-53.67	-30.00	23.67	16.72	RMS	Vertical

Project No	E20210426746801	EUT:	Camera Hub G3
Model:	CH-H03	Sample No:	E20210426746801-0008
Mode:	TX 802.11n20 2472MHz	Voltage:	AC230V/50Hz
Environment:	Temp:24.5°C;Humi:59%	Engineer:	Chen Xiacong

**Suspected Data List**

NO.	Freq. [MHz]	Reading [dBm]	Level [dBm]	Limit [dBm]	Margin [dB]	Factor [dB]	Detector	Polarity
1	1178.000	-44.98	-59.36	-30.00	29.36	-14.38	RMS	Horizontal
2	1599.100	-42.79	-56.39	-30.00	26.39	-13.60	RMS	Horizontal
3	2474.900	-35.32	-44.36	-30.00	14.36	-9.04	RMS	Horizontal
4	4806.675	-50.86	-48.95	-30.00	18.95	1.91	RMS	Horizontal
5	6591.900	-58.07	-53.39	-30.00	23.39	4.68	RMS	Horizontal
6	10799.02	-70.51	-53.46	-30.00	23.46	17.05	RMS	Horizontal

**Suspected Data List**

NO.	Freq. [MHz]	Reading [dBm]	Level [dBm]	Limit [dBm]	Margin [dB]	Factor [dB]	Detector	Polarity
1	1593.800	-40.00	-53.50	-30.00	23.50	-13.50	RMS	Vertical
2	2471.000	-35.85	-44.90	-30.00	14.90	-9.05	RMS	Vertical
3	2994.200	-54.41	-61.51	-30.00	31.51	-7.10	RMS	Vertical
4	3599.625	-58.76	-60.25	-30.00	30.25	-1.49	RMS	Vertical
5	4806.675	-52.45	-50.47	-30.00	20.47	1.98	RMS	Vertical
6	6591.900	-59.80	-55.52	-30.00	25.52	4.28	RMS	Vertical

Project No	E20210426746801	EUT:	Camera Hub G3
Model:	CH-H03	Sample No:	E20210426746801-0008
Mode:	TX 802.11n40 2422MHz	Voltage:	AC230V/50Hz
Environment:	Temp:24.5°C;Humi:59%	Engineer:	Chen Xiacong

**Suspected Data List**

NO.	Freq. [MHz]	Reading [dBm]	Level [dBm]	Limit [dBm]	Margin [dB]	Factor [dB]	Detector	Polarity
1	1599.100	-44.01	-57.61	-30.00	27.61	-13.60	RMS	Horizontal
2	2386.100	-35.81	-44.41	-30.00	14.41	-8.60	RMS	Horizontal
3	3594.750	-61.49	-63.48	-30.00	33.48	-1.99	RMS	Horizontal
4	4806.675	-50.99	-49.08	-30.00	19.08	1.91	RMS	Horizontal
5	6458.325	-59.41	-55.55	-30.00	25.55	3.86	RMS	Horizontal
6	8805.150	-68.36	-54.99	-30.00	24.99	13.37	RMS	Horizontal

**Suspected Data List**

NO.	Freq. [MHz]	Reading [dBm]	Level [dBm]	Limit [dBm]	Margin [dB]	Factor [dB]	Detector	Polarity
1	1599.300	-37.75	-51.13	-30.00	21.13	-13.38	RMS	Vertical
2	2381.200	-36.11	-44.44	-30.00	14.44	-8.33	RMS	Vertical
3	3595.725	-61.04	-62.67	-30.00	32.67	-1.63	RMS	Vertical
4	4806.675	-52.45	-50.47	-30.00	20.47	1.98	RMS	Vertical
5	6459.300	-58.28	-54.43	-30.00	24.43	3.85	RMS	Vertical
6	9217.575	-67.88	-54.61	-30.00	24.61	13.27	RMS	Vertical

Project No	E20210426746801	EUT:	Camera Hub G3
Model:	CH-H03	Sample No:	E20210426746801-0008
Mode:	TX 802.11n40 2462MHz	Voltage:	AC230V/50Hz
Environment:	Temp:24.5°C;Humi:59%	Engineer:	Chen Xiacong

**Suspected Data List**

NO.	Freq. [MHz]	Reading [dBm]	Level [dBm]	Limit [dBm]	Margin [dB]	Factor [dB]	Detector	Polarity
1	1000.000	-41.31	-55.19	-30.00	25.19	-13.88	RMS	Horizontal
2	1597.800	-43.89	-57.51	-30.00	27.51	-13.62	RMS	Horizontal
3	2474.900	-38.98	-48.02	-30.00	18.02	-9.04	RMS	Horizontal
4	4806.675	-51.06	-49.15	-30.00	19.15	1.91	RMS	Horizontal
5	6565.575	-57.04	-52.90	-30.00	22.90	4.14	RMS	Horizontal
6	8823.675	-67.95	-55.05	-30.00	25.05	12.90	RMS	Horizontal

**Suspected Data List**

NO.	Freq. [MHz]	Reading [dBm]	Level [dBm]	Limit [dBm]	Margin [dB]	Factor [dB]	Detector	Polarity
1	1000.000	-39.39	-52.36	-30.00	22.36	-12.97	RMS	Vertical
2	1598.400	-36.72	-50.12	-30.00	20.12	-13.40	RMS	Vertical
3	2503.900	-38.00	-47.44	-30.00	17.44	-9.44	RMS	Vertical
4	4806.675	-52.51	-50.53	-30.00	20.53	1.98	RMS	Vertical
5	6565.575	-57.82	-54.11	-30.00	24.11	3.71	RMS	Vertical
6	9221.475	-67.98	-54.72	-30.00	24.72	13.26	RMS	Vertical



### 5.7 RECEIVER SPURIOUS EMISSIONS

Test Requirement: EN300 328 V2.2.2/ 4.3.2.10

Test Method: EN300 328 V2.2.2/5.4.10.2.2

#### 5.7.1 LIMIT

The spurious emissions of the receiver shall not exceed the values given in table 3.

In case of equipment with antenna connectors, these limits apply to emissions at the antenna port (conducted). For emissions radiated by the cabinet or for emissions radiated by integral antenna equipment (without antenna connectors), these limits are e.r.p. for emissions up to 1 GHz and e.i.r.p. for emissions above 1 GHz.

This device uses Radiated measurement.

Table 3: Spurious emission limits for receivers

Frequency range	Maximum power	Bandwidth
30 MHz to 1 GHz	-57 dBm	100 kHz
1 GHz to 12,75 GHz	-47 dBm	1 MHz

#### 5.7.2 TEST CONFIGURATION

(1) 30MHz-1000MHz

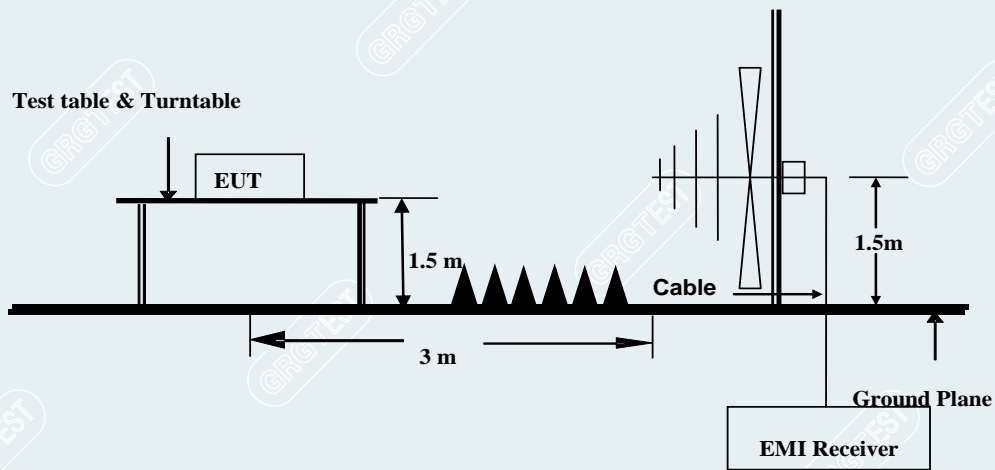

## (3) 1000MHz-12750MHz

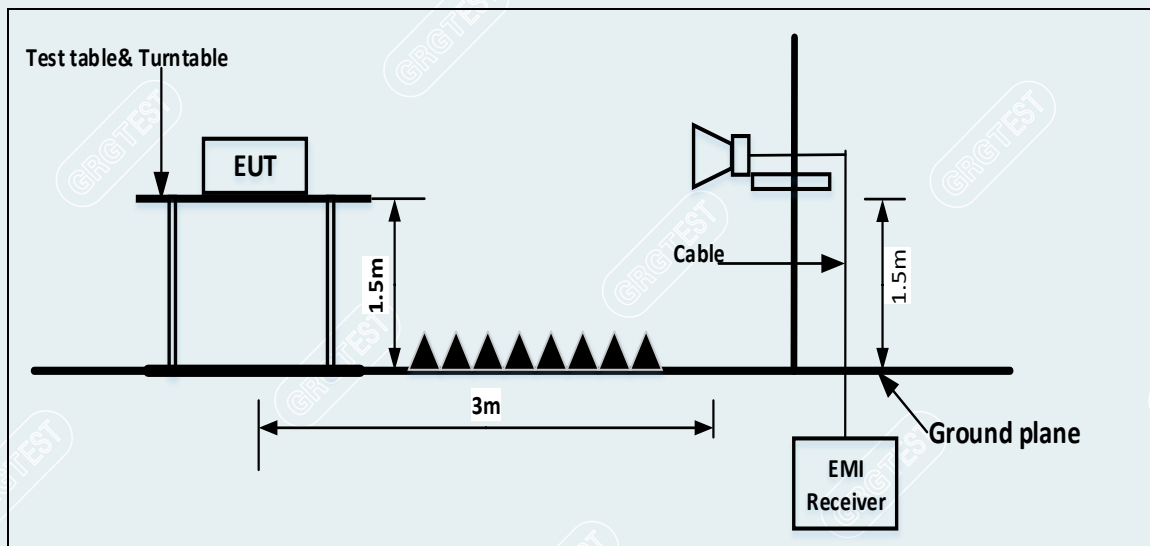

## 5.7.3 TEST PROCEDURES

Test channel: 2412MHz, 2472MHz for 802.11b/g/n HT20

2422MHz, 2462MHz for 802.11n HT40

Test condition: Normal test conditions.

Test procedure: Test procedure is according to Clause 5.4.10.2.2 of EN 300 328 V2.2.2

1. The EUT shall be performed at the receiver mode and Interface cables, loads, and devices should be connected to at least one of each type of the interface ports of the EUT and, where practical, each cable shall be terminated in a device typical for its actual use. EUT shall be placed at the 1.5m support on the turntable.
2. The test antenna at a horizontal distance of 3 m .It shall be raised and Lowested from 1m to 4m until a maximum signal level is detected by the measuring receiver. Then the turntable should be rotated through 360 ° in the horizontal plane, until the maximum signal level is detected by the measuring receiver. In both the vertical and the horizontal polarization. Record the reading level, antenna position, polarization and turntable position.
3. Remove the EUT and replace it with a substitution antenna.
4. Feed the substitution antenna at the EUT end with a signal generator connected to the antenna by a cable. With the antennas at both ends vertically polarized, and with the signal generator tuned to a particular test frequency, raise and Lowest the test antenna to obtain a maximum reading at the spectrum analyzer. Adjust the level of the signal generator output until the previously recorded maximum reading for this set of conditions is obtained. This should be done carefully repeating the adjustment of the test antenna and generator output.
5.  $ERP(dBm) = Pg(dBm) - \text{cable loss (dB)} + \text{antenna gain (dBd)}$   
 $EIRP(dBm) = Pg(dBm) - \text{cable loss (dB)} + \text{antenna gain (dBi)}$

Remark:

Where:Pg is the generator output power into the substitution antenna  
 Pre-test all data rate and channel, found that 802.11b is the worst case, so only record the worst data.

**5.7.4 DATA SAMPLE**

Freq. [MHz]	Reading [dBm]	Level [dBm]	Limit [dBm]	Margin [dB]	Factor [dB/m]	Detector	Polarity
XXX	-58.02	-73.33	-57.00	16.33	-15.31	RMS	Horizontal

Frequency (MHz)	= Emission frequency in MHz
Reading (dBm)	= Uncorrected Analyzer / Receiver reading
Correct Factor (dB/m)	= Antenna factor + Cable loss – Amplifier gain
Result (dBm)	= Reading (dBm) + Corr. Factor (dB/m)
Limit (dBm)	= Limit stated in standard
Margin (dB)	= Result (dBm) – Limit(dBm)
RMS	= Root Mean Square

### 5.7.5 TEST RESULTS

Below 1GHz

Recorded the worst case results in this report (IEEE 802.11b)

Adapter1:

Project No	E20210426746801	EUT:	Camera Hub G3
Model:	CH-H03	Sample No:	E20210426746801-0008
Mode:	RX 802.11b 2412MHz	Voltage:	230V/50Hz
Environment:	Temp:24.5°C ;Humi:59%	Engineer:	Chen Xiacong

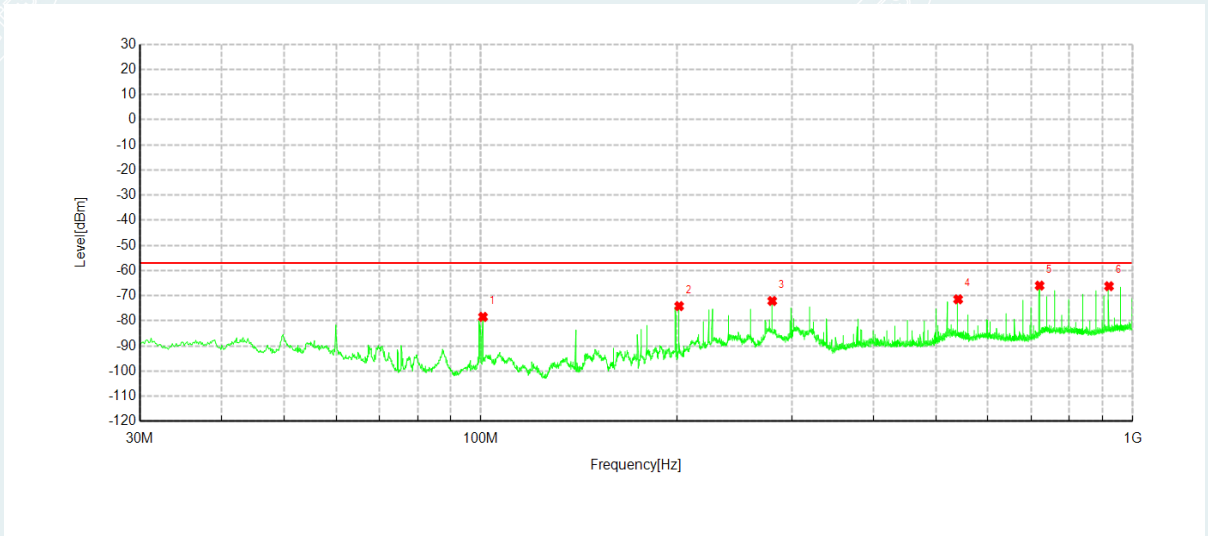

Suspected Data List								
NO.	Freq. [MHz]	Reading [dBm]	Level [dBm]	Limit [dBm]	Margin [dB]	Factor [dB]	Detector	Polarity
1	100.8100	-55.71	-78.43	-57.00	21.43	-22.72	RMS	Horizontal
2	201.5688	-54.79	-74.15	-57.00	17.15	-19.36	RMS	Horizontal
3	280.0175	-56.36	-72.11	-57.00	15.11	-15.75	RMS	Horizontal
4	539.9775	-61.29	-71.44	-57.00	14.44	-10.15	RMS	Horizontal
5	720.0338	-58.03	-65.99	-57.00	8.99	-7.96	RMS	Horizontal
6	919.9750	-61.32	-66.23	-57.00	9.23	-4.91	RMS	Horizontal

Project No	E20210426746801	EUT:	Camera Hub G3
Model:	CH-H03	Sample No:	E20210426746801-0008
Mode:	RX 802.11b 2412MHz	Voltage:	230V/50Hz
Environment:	Temp:24.5℃;Humi:59%	Engineer:	Chen Xiacong

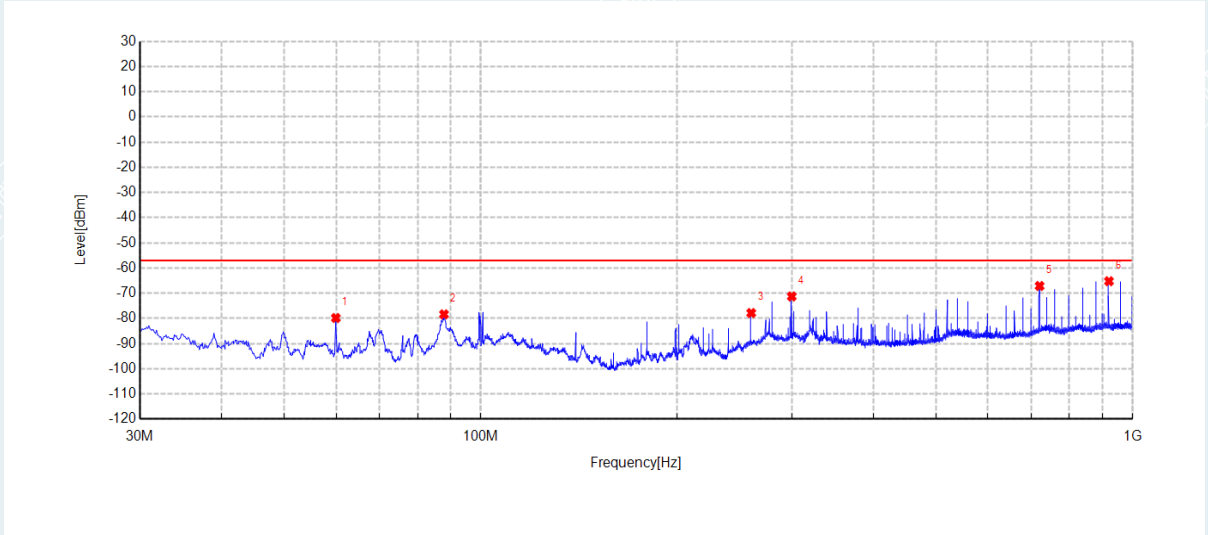

Suspected Data List								
NO.	Freq. [MHz]	Reading [dBm]	Level [dBm]	Limit [dBm]	Margin [dB]	Factor [dB]	Detector	Polarity
1	59.9488	-59.98	-79.83	-57.00	22.83	-19.85	RMS	Vertical
2	87.8363	-59.78	-78.37	-57.00	21.37	-18.59	RMS	Vertical
3	260.0113	-60.17	-77.85	-57.00	20.85	-17.68	RMS	Vertical
4	300.0238	-55.75	-71.27	-57.00	14.27	-15.52	RMS	Vertical
5	720.0338	-59.78	-67.11	-57.00	10.11	-7.33	RMS	Vertical
6	919.9750	-60.33	-65.23	-57.00	8.23	-4.90	RMS	Vertical

Project No	E20210426746801	EUT:	Camera Hub G3
Model:	CH-H03	Sample No:	E20210426746801-0008
Mode:	RX 802.11b 2472MHz	Voltage:	230V/50Hz
Environment:	Temp:24.5°C ;Humi:59%	Engineer:	Chen Xiacong

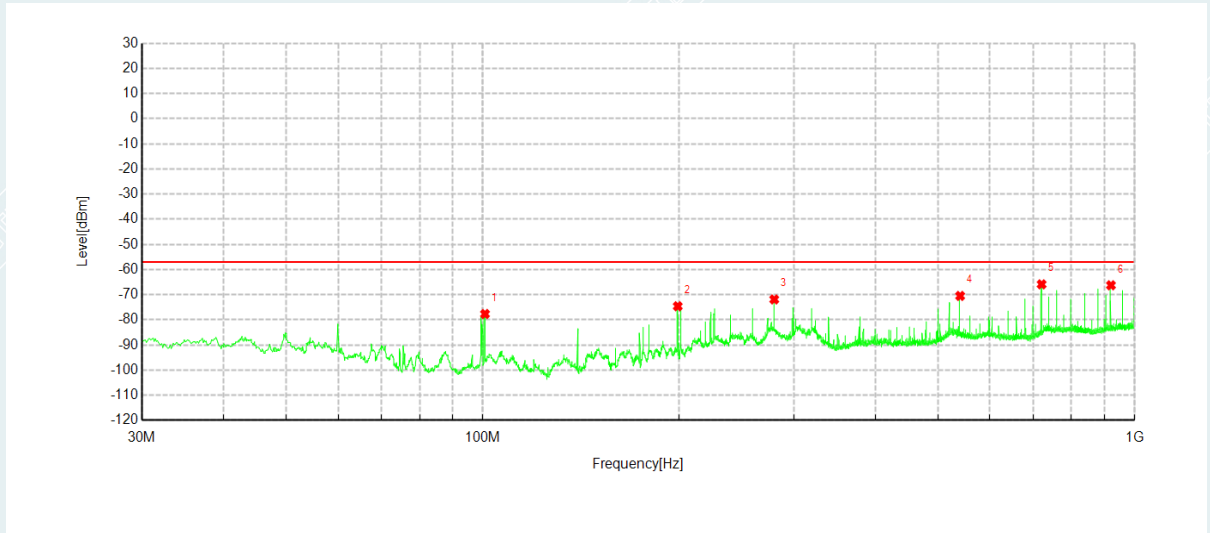

Suspected Data List								
NO.	Freq. [MHz]	Reading [dBm]	Level [dBm]	Limit [dBm]	Margin [dB]	Factor [dB]	Detector	Polarity
1	100.8100	-54.94	-77.66	-57.00	20.66	-22.72	RMS	Horizontal
2	199.1438	-55.09	-74.59	-57.00	17.59	-19.50	RMS	Horizontal
3	280.0175	-56.14	-71.89	-57.00	14.89	-15.75	RMS	Horizontal
4	539.9775	-60.34	-70.49	-57.00	13.49	-10.15	RMS	Horizontal
5	720.0338	-57.91	-65.87	-57.00	8.87	-7.96	RMS	Horizontal
6	919.9750	-61.34	-66.25	-57.00	9.25	-4.91	RMS	Horizontal

Project No	E20210426746801	EUT:	Camera Hub G3
Model:	CH-H03	Sample No:	E20210426746801-0008
Mode:	RX 802.11b 2472MHz	Voltage:	230V/50Hz
Environment:	Temp:24.5°C ;Humi:59%	Engineer:	Chen Xiacong

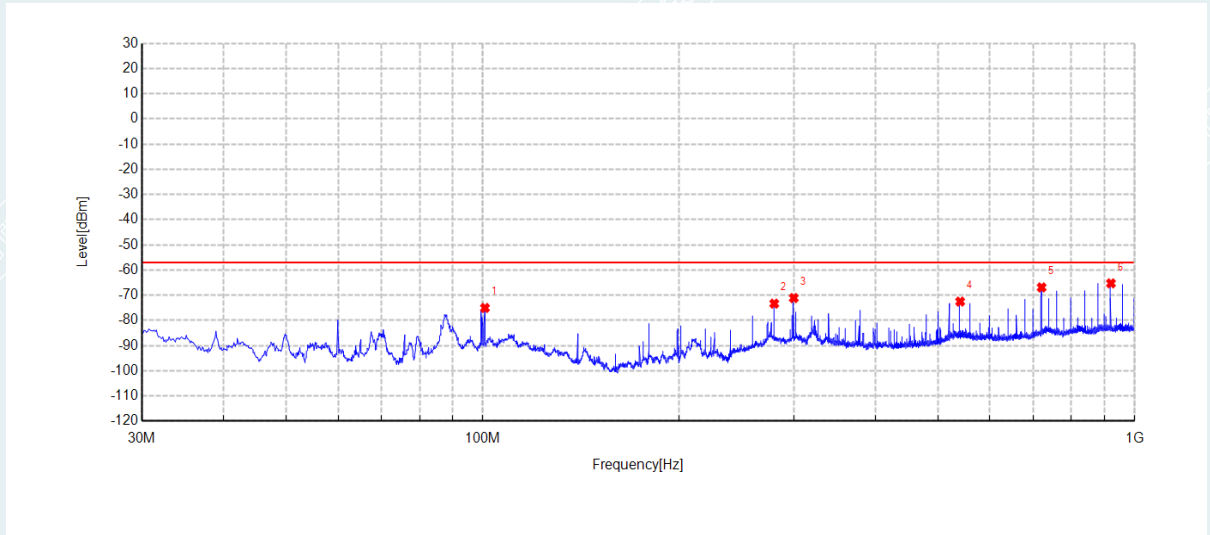

Suspected Data List								
NO.	Freq. [MHz]	Reading [dBm]	Level [dBm]	Limit [dBm]	Margin [dB]	Factor [dB]	Detector	Polarity
1	100.8100	-60.46	-75.04	-57.00	18.04	-14.58	RMS	Vertical
2	280.0175	-57.04	-73.32	-57.00	16.32	-16.28	RMS	Vertical
3	300.0238	-55.59	-71.11	-57.00	14.11	-15.52	RMS	Vertical
4	539.9775	-62.06	-72.51	-57.00	15.51	-10.45	RMS	Vertical
5	720.0338	-59.56	-66.89	-57.00	9.89	-7.33	RMS	Vertical
6	919.9750	-60.38	-65.28	-57.00	8.28	-4.90	RMS	Vertical

Adapter 2:

Project No	E20210426746801	EUT:	Camera Hub G3
Model:	CH-H03	Sample No:	E20210426746801-0008
Mode:	RX 802.11b 2412MHz	Voltage:	230V/50Hz
Environment:	Temp:25.1 °C;Humi:54%	Engineer:	Chen Xiacong

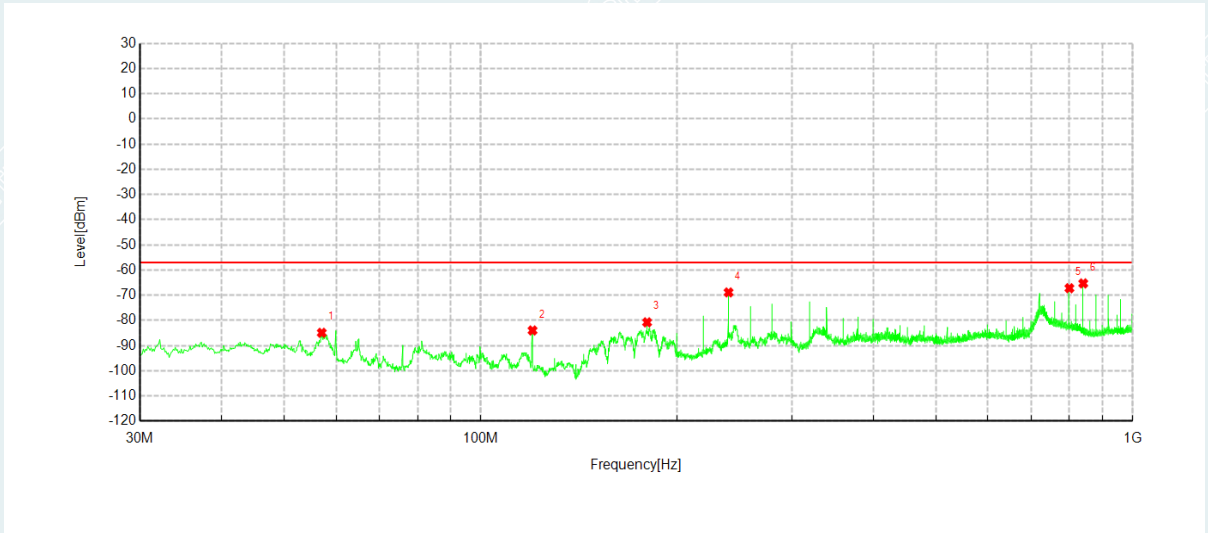

Suspected Data List								
NO.	Freq. [MHz]	Reading [dBm]	Level [dBm]	Limit [dBm]	Margin [dB]	Factor [dB]	Detector	Polarity
1	57.0388	-69.57	-84.91	-57.00	27.91	-15.34	RMS	Horizontal
2	120.0888	-59.05	-83.98	-57.00	26.98	-24.93	RMS	Horizontal
3	179.9863	-58.72	-80.75	-57.00	23.75	-22.03	RMS	Horizontal
4	240.0050	-54.92	-68.88	-57.00	11.88	-13.96	RMS	Horizontal
5	799.9375	-61.57	-67.22	-57.00	10.22	-5.65	RMS	Horizontal
6	839.9500	-59.17	-65.30	-57.00	8.30	-6.13	RMS	Horizontal



Project No	E20210426746801	EUT:	Camera Hub G3
Model:	CH-H03	Sample No:	E20210426746801-0008
Mode:	RX 802.11b 2412MHz	Voltage:	230V/50Hz
Environment:	Temp:25.1 °C;Humi:54%	Engineer:	Chen Xiacong

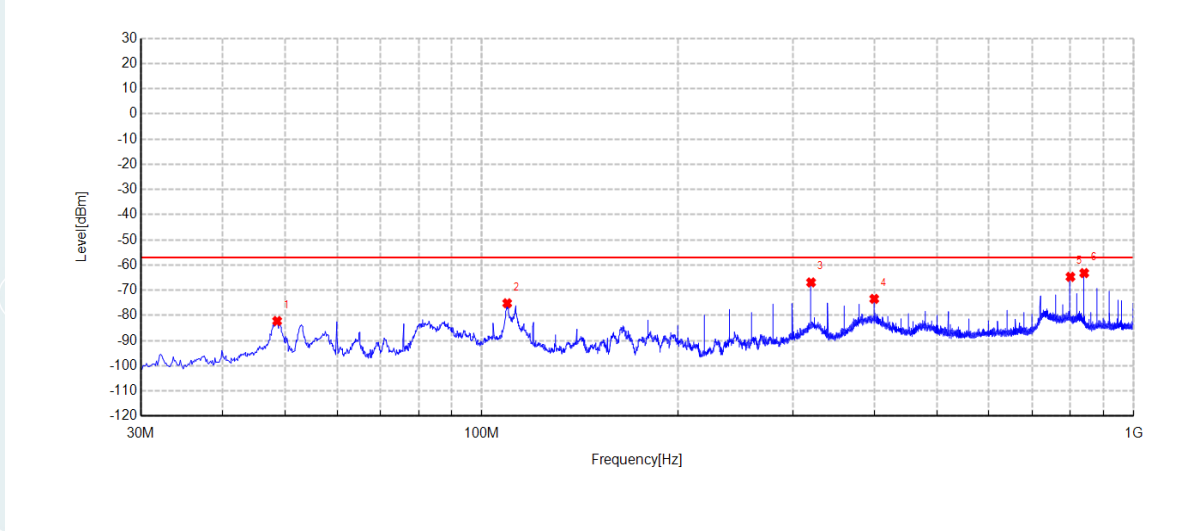

Suspected Data List								
NO.	Freq. [MHz]	Reading [dBm]	Level [dBm]	Limit [dBm]	Margin [dB]	Factor [dB]	Detector	Polarity
1	48.5513	-60.83	-82.21	-57.00	25.21	-21.38	RMS	Vertical
2	109.4188	-63.50	-75.16	-57.00	18.16	-11.66	RMS	Vertical
3	320.0300	-52.11	-66.90	-57.00	9.90	-14.79	RMS	Vertical
4	400.0550	-60.31	-73.43	-57.00	16.43	-13.12	RMS	Vertical
5	799.9375	-58.33	-64.68	-57.00	7.68	-6.35	RMS	Vertical
6	839.9500	-56.99	-63.19	-57.00	6.19	-6.20	RMS	Vertical

Project No	E20210426746801	EUT:	Camera Hub G3
Model:	CH-H03	Sample No:	E20210426746801-0008
Mode:	RX 802.11b 2472MHz	Voltage:	230V/50Hz
Environment:	Temp:25.1℃;Humi:54%	Engineer:	Chen Xiacong

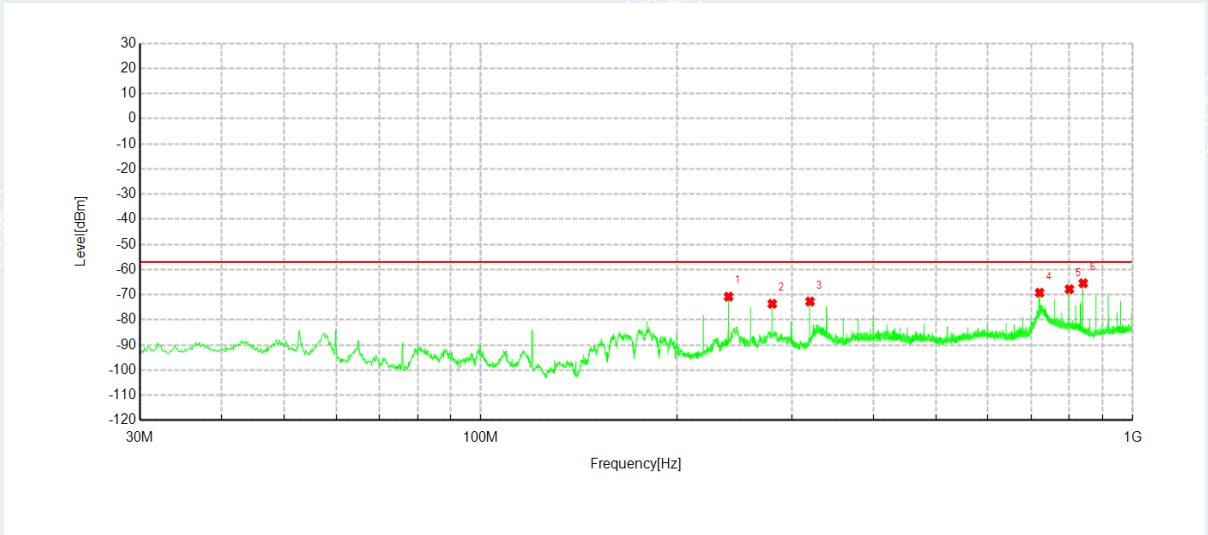

Suspected Data List								
NO.	Freq. [MHz]	Reading [dBm]	Level [dBm]	Limit [dBm]	Margin [dB]	Factor [dB]	Detector	Polarity
1	240.0050	-56.83	-70.79	-57.00	13.79	-13.96	RMS	Horizontal
2	280.0175	-57.88	-73.63	-57.00	16.63	-15.75	RMS	Horizontal
3	320.0300	-56.33	-72.72	-57.00	15.72	-16.39	RMS	Horizontal
4	720.0338	-61.24	-69.20	-57.00	12.20	-7.96	RMS	Horizontal
5	799.9375	-62.16	-67.81	-57.00	10.81	-5.65	RMS	Horizontal
6	839.9500	-59.33	-65.46	-57.00	8.46	-6.13	RMS	Horizontal

Project No	E20210426746801	EUT:	Camera Hub G3
Model:	CH-H03	Sample No:	E20210426746801-0008
Mode:	RX 802.11b 2472MHz	Voltage:	230V/50Hz
Environment:	Temp:25.1 °C ;Humi:54%	Engineer:	Chen Xiacong

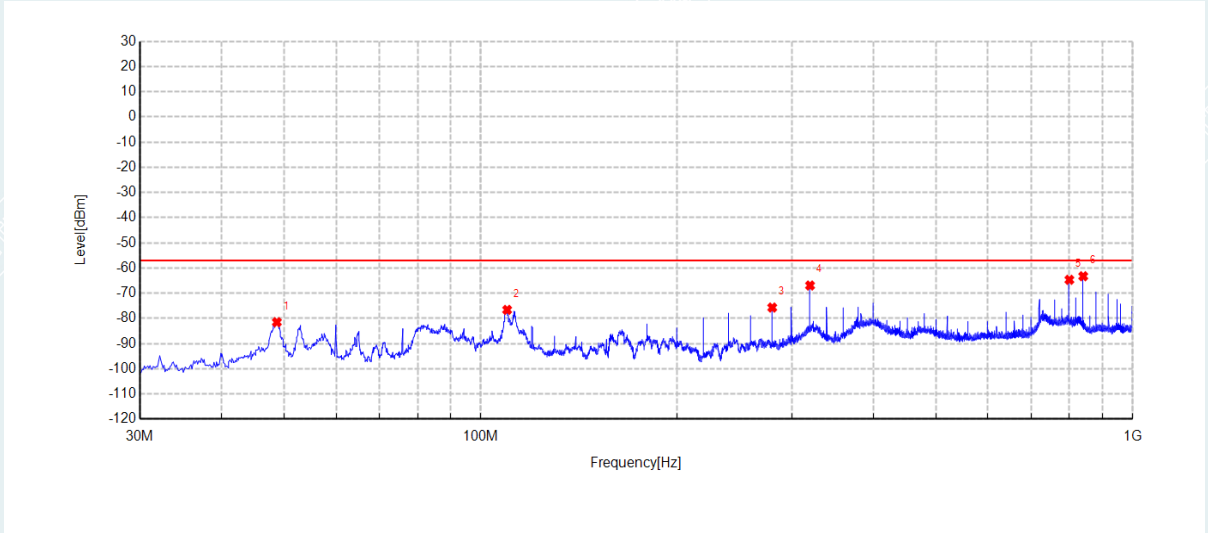

Suspected Data List								
NO.	Freq. [MHz]	Reading [dBm]	Level [dBm]	Limit [dBm]	Margin [dB]	Factor [dB]	Detector	Polarity
1	48.6725	-60.09	-81.49	-57.00	24.49	-21.40	RMS	Vertical
2	109.7825	-65.06	-76.59	-57.00	19.59	-11.53	RMS	Vertical
3	280.0175	-59.41	-75.69	-57.00	18.69	-16.28	RMS	Vertical
4	320.0300	-52.14	-66.93	-57.00	9.93	-14.79	RMS	Vertical
5	799.9375	-58.31	-64.66	-57.00	7.66	-6.35	RMS	Vertical
6	839.9500	-57.04	-63.24	-57.00	6.24	-6.20	RMS	Vertical

Above 1GHz

Adapter 1:

Project No	E20210426746801	EUT:	Camera Hub G3
Model:	CH-H03	Sample No:	E20210426746801-0008
Mode:	RX 802.11b 2412MHz	Voltage:	230V/50Hz
Environment:	Temp:24.5°C;Humi:59%	Engineer:	Chen Xiacong

**Suspected Data List**

NO.	Freq. [MHz]	Reading [dBm]	Level [dBm]	Limit [dBm]	Margin [dB]	Factor [dB]	Detector	Polarity
1	1079.903	-50.81	-65.52	-47.00	18.52	-14.71	RMS	Horizontal
2	1380.245	-54.46	-67.53	-47.00	20.53	-13.07	RMS	Horizontal
3	1809.372	-54.06	-67.00	-47.00	20.00	-12.94	RMS	Horizontal
4	3618.944	-57.25	-60.66	-47.00	13.66	-3.41	RMS	Horizontal
5	4806.682	-58.61	-57.18	-47.00	10.18	1.43	RMS	Horizontal
6	6432.007	-56.79	-53.76	-47.00	6.76	3.03	RMS	Horizontal

**Suspected Data List**

NO.	Freq. [MHz]	Reading [dBm]	Level [dBm]	Limit [dBm]	Margin [dB]	Factor [dB]	Detector	Polarity
1	1000.000	-51.74	-65.22	-47.00	18.22	-13.48	RMS	Vertical
2	1500.100	-52.88	-65.87	-47.00	18.87	-12.99	RMS	Vertical
3	1779.291	-51.42	-63.78	-47.00	16.78	-12.36	RMS	Vertical
4	3618.474	-59.52	-62.68	-47.00	15.68	-3.16	RMS	Vertical
5	4806.682	-60.58	-59.08	-47.00	12.08	1.50	RMS	Vertical
6	6432.007	-54.88	-51.56	-47.00	4.56	3.32	RMS	Vertical

Project No	E20210426746801	EUT:	Camera Hub G3
Model:	CH-H03	Sample No:	E20210426746801-0008
Mode:	RX 802.11b 2472MHz	Voltage:	230V/50Hz
Environment:	Temp:24.5℃;Humi:59%	Engineer:	Chen Xiacong

**Suspected Data List**

NO.	Freq. [MHz]	Reading [dBm]	Level [dBm]	Limit [dBm]	Margin [dB]	Factor [dB]	Detector	Polarity
1	1079.903	-51.21	-65.92	-47.00	18.92	-14.71	RMS	Horizontal
2	1379.775	-54.44	-67.53	-47.00	20.53	-13.09	RMS	Horizontal
3	1809.372	-54.20	-67.14	-47.00	20.14	-12.94	RMS	Horizontal
4	3618.944	-56.63	-60.04	-47.00	13.04	-3.41	RMS	Horizontal
5	4806.682	-58.88	-57.45	-47.00	10.45	1.43	RMS	Horizontal
6	6591.813	-59.47	-55.23	-47.00	8.23	4.24	RMS	Horizontal

**Suspected Data List**

NO.	Freq. [MHz]	Reading [dBm]	Level [dBm]	Limit [dBm]	Margin [dB]	Factor [dB]	Detector	Polarity
1	1079.903	-49.14	-64.92	-47.00	17.92	-15.78	RMS	Vertical
2	1809.372	-53.50	-64.58	-47.00	17.58	-11.08	RMS	Vertical
3	2800.172	-58.05	-66.84	-47.00	19.84	-8.79	RMS	Vertical
4	3618.944	-60.11	-63.28	-47.00	16.28	-3.17	RMS	Vertical
5	4806.682	-60.33	-58.83	-47.00	11.83	1.50	RMS	Vertical
6	6591.813	-60.17	-56.33	-47.00	9.33	3.84	RMS	Vertical

Project No	E20210426746801	EUT:	Camera Hub G3
Model:	CH-H03	Sample No:	E20210426746801-0008
Mode:	RX 802.11n40 2422MHz	Voltage:	230V/50Hz
Environment:	Temp:24.5℃;Humi:59%	Engineer:	Chen Xiacong

**Suspected Data List**

NO.	Freq. [MHz]	Reading [dBm]	Level [dBm]	Limit [dBm]	Margin [dB]	Factor [dB]	Detector	Polarity
1	1079.903	-48.46	-63.17	-47.00	16.17	-14.71	RMS	Horizontal
2	1199.758	-52.09	-66.63	-47.00	19.63	-14.54	RMS	Horizontal
3	1500.100	-56.84	-70.22	-47.00	23.22	-13.38	RMS	Horizontal
4	1809.372	-51.95	-64.89	-47.00	17.89	-12.94	RMS	Horizontal
5	3618.474	-57.46	-60.86	-47.00	13.86	-3.40	RMS	Horizontal
6	6458.798	-55.83	-52.60	-47.00	5.60	3.23	RMS	Horizontal

**Suspected Data List**

NO.	Freq. [MHz]	Reading [dBm]	Level [dBm]	Limit [dBm]	Margin [dB]	Factor [dB]	Detector	Polarity
1	1079.903	-50.17	-65.95	-47.00	18.95	-15.78	RMS	Vertical
2	1279.661	-53.46	-67.60	-47.00	20.60	-14.14	RMS	Vertical
3	1500.100	-52.31	-65.30	-47.00	18.30	-12.99	RMS	Vertical
4	1809.372	-54.41	-65.49	-47.00	18.49	-11.08	RMS	Vertical
5	3618.944	-57.38	-60.55	-47.00	13.55	-3.17	RMS	Vertical
6	6458.798	-56.30	-53.10	-47.00	6.10	3.20	RMS	Vertical

Project No	E20210426746801	EUT:	Camera Hub G3
Model:	CH-H03	Sample No:	E20210426746801-0008
Mode:	RX 802.11n40 2462MHz	Voltage:	230V/50Hz
Environment:	Temp:24.5℃;Humi:59%	Engineer:	Chen Xiacong

**Suspected Data List**

NO.	Freq. [MHz]	Reading [dBm]	Level [dBm]	Limit [dBm]	Margin [dB]	Factor [dB]	Detector	Polarity
1	1079.903	-48.55	-63.26	-47.00	16.26	-14.71	RMS	Horizontal
2	1199.758	-52.30	-66.84	-47.00	19.84	-14.54	RMS	Horizontal
3	1320.082	-53.70	-67.22	-47.00	20.22	-13.52	RMS	Horizontal
4	1809.372	-52.21	-65.15	-47.00	18.15	-12.94	RMS	Horizontal
5	3618.944	-57.65	-61.06	-47.00	14.06	-3.41	RMS	Horizontal
6	6565.492	-56.92	-53.26	-47.00	6.26	3.66	RMS	Horizontal

**Suspected Data List**

NO.	Freq. [MHz]	Reading [dBm]	Level [dBm]	Limit [dBm]	Margin [dB]	Factor [dB]	Detector	Polarity
1	1000.000	-52.42	-65.90	-47.00	18.90	-13.48	RMS	Vertical
2	1280.131	-53.24	-67.36	-47.00	20.36	-14.12	RMS	Vertical
3	1500.100	-52.23	-65.22	-47.00	18.22	-12.99	RMS	Vertical
4	1540.051	-54.18	-68.98	-47.00	21.98	-14.80	RMS	Vertical
5	3618.944	-58.19	-61.36	-47.00	14.36	-3.17	RMS	Vertical
6	6565.492	-57.13	-53.90	-47.00	6.90	3.23	RMS	Vertical

## 5.8 RECEIVER BLOCKING

Test Requirement: EN300 328 V2.2.2/ 4.3.2.11

Test Method: EN300 328 V2.2.2/5.4.11.2.1

### 5.8.1 LIMIT

For equipment that supports a PER or FER test to be performed, the minimum performance criterion shall be a PER or FER less than or equal to 10 %.

For equipment that does not support a PER or a FER test to be performed, the minimum performance criterion shall be no loss of the wireless transmission function needed for the intended use of the equipment.

The blocking levels at specified frequency offsets shall be equal to or greater than the limits defined for.

**Receiver Blocking parameters for Receiver Category 1 equipment**

Wanted signal mean power from companion device (dBm) (see notes 1 and 4)	Blocking Signal frequency (MHz)	Blocking signal power (dBm) (see note 4)	Type of blocking signal
$(-133\text{dBm} + 10 \times \log_{10}(\text{OCBW}))$ or $-68\text{dBm}$ whichever is less (see note 2)	2380 2504	-34	CW
$(-139\text{dBm} + 10 \times \log_{10}(\text{OCBW}))$ or $-74\text{dBm}$ whichever is less (see note 3)	2300 2330 2360 2524 2584 2674		
<p>NOTE 1: OCBW is in Hz.</p> <p>NOTE 2: In case of radiated measurements using a companion device and the level of the wanted signal from the companion device cannot be determined, a relative test may be performed using a wanted signal up to <math>P_{\min} + 26</math> dB where <math>P_{\min}</math> is the minimum level of wanted signal required to meet the minimum performance criteria as defined in clause 4.3.1.12.3 in the absence of any blocking signal.</p> <p>NOTE 3: In case of radiated measurements using a companion device and the level of the wanted signal from the companion device cannot be determined, a relative test may be performed using a wanted signal up to <math>P_{\min} + 20</math> dB where <math>P_{\min}</math> is the minimum level of wanted signal required to meet the minimum performance criteria as defined in clause 4.3.1.12.3 in the absence of any blocking signal.</p> <p>NOTE 4: The level specified is the level at the UUT receiver input assuming a 0 dBi antenna assembly gain. In case of conducted measurements, this level has to be corrected for the (in-band) antenna assembly gain (G). In case of radiated measurements, this level is equivalent to a power flux density (PFD) in front of the UUT antenna with the UUT being configured/positioned as recorded in clause 5.4.3.2.2.</p>			



**Receiver Blocking parameters for Receiver Category 2 equipment**

<b>Wanted signal mean power from companion device (dBm) (see notes 1 and 3)</b>	<b>Blocking Signal frequency (MHz)</b>	<b>Blocking signal power (dBm) (see note 3)</b>	<b>Type of blocking signal</b>
$(-139\text{dBm} + 10 \times \log_{10}(\text{OCBW}) + 10\text{dBm})$ or $(-74\text{dBm} + 10\text{dBm})$ whichever is less (see note 2)	2380 2504 2300 2584	-34	CW
<p>NOTE 1: OCBW is in Hz.</p> <p>NOTE 2: In case of radiated measurements using a companion device and the level of the wanted signal from the companion device cannot be determined, a relative test may be performed using a wanted signal up to <math>P_{\min} + 26</math> dB where <math>P_{\min}</math> is the minimum level of wanted signal required to meet the minimum performance criteria as defined in clause 4.3.1.12.3 in the absence of any blocking signal.</p> <p>NOTE 3: The level specified is the level at the UUT receiver input assuming a 0 dBi antenna assembly gain. In case of conducted measurements, this level has to be corrected for the (in-band) antenna assembly gain (G). In case of radiated measurements, this level is equivalent to a power flux density (PFD) in front of the UUT antenna with the UUT being configured/positioned as recorded in clause 5.4.3.2.2.</p>			

**Receiver Blocking parameters for Receiver Category 3 equipment**

<b>Wanted signal mean power from companion device (dBm) (see notes 1 and 3)</b>	<b>Blocking Signal frequency (MHz)</b>	<b>Blocking signal power (dBm) (see note 3)</b>	<b>Type of blocking signal</b>
$(-139\text{dBm} + 10 \times \log_{10}(\text{OCBW}) + 20\text{dBm})$ or $(-74\text{dBm} + 20\text{dBm})$ whichever is less (see note 2)	2380 2504 2300 2584	-34	CW
<p>NOTE 1: OCBW is in Hz.</p> <p>NOTE 2: In case of radiated measurements using a companion device and the level of the wanted signal from the companion device cannot be determined, a relative test may be performed using a wanted signal up to <math>P_{\min} + 30</math> dB where <math>P_{\min}</math> is the minimum level of wanted signal required to meet the minimum performance criteria as defined in clause 4.3.1.12.3 in the absence of any blocking signal.</p> <p>NOTE 3: The level specified is the level at the UUT receiver input assuming a 0 dBi antenna assembly gain. In case of conducted measurements, this level has to be corrected for the (in-band) antenna assembly gain (G). In case of radiated measurements, this level is equivalent to a power flux density (PFD) in front of the UUT antenna with the UUT being configured/positioned as recorded in clause 5.4.3.2.2.</p>			

## 5.8.2 TEST CONFIGURATION

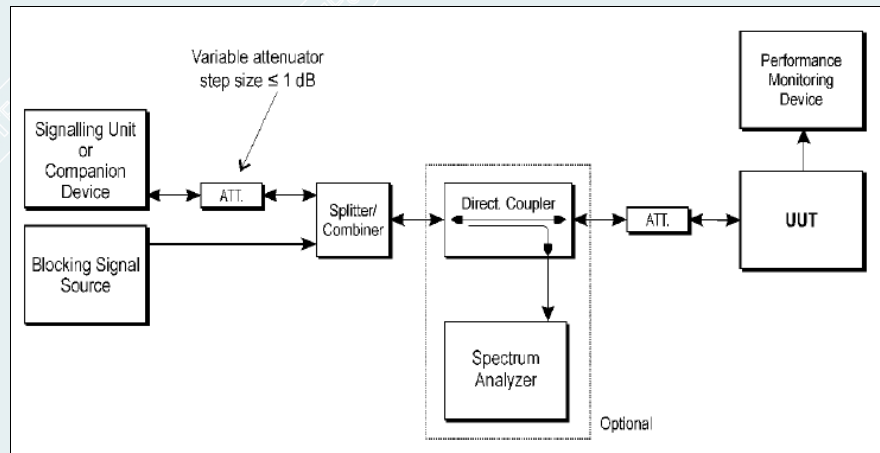

## 5.8.3 TEST PROCEDURES

Test condition: Keep the EUT on the lowest and highest channel working mode.

Test procedure: Step 1:

Test condition: For non-FHSS equipment, the UUT shall be set to the lowest operating channel on which the blocking test has to be performed (see clause 5.4.11.1).

Step 2:

The blocking signal generator is set to the first frequency as defined in the appropriate table corresponding to the receiver category and type of equipment.

Step 3:

With the blocking signal generator switched off, a communication link is established between the UUT and the associated companion device using the test setup shown in figure 6.

Unless the option provided in note 2 of the applicable table referred to in clause 5.4.11.2.1 is used, the level of the wanted signal shall be set to the value provided in the table corresponding to the receiver category and type of equipment. The test procedure defined in clause 5.4.2, and more in particular clause 5.4.2.2.1.2, can be used to measure the (conducted) level of the wanted signal however no correction shall be made for antenna gain of the companion device (step 6 in clause 5.4.2.2.1.2 shall be ignored). This level may be measured directly at the output of the companion device and a correction is made for the coupling loss into the UUT. The actual level for the wanted signal shall be recorded in the test report.

- When the option provided in note 2 of the applicable table referred to in clause 5.4.11.2.1 is used, the attenuation of the variable attenuator shall be increased in 1 dB steps to a value at which the minimum performance criteria as specified in clause 4.3.1.12.3 or clause 4.3.2.11.3 is still met. The resulting level for the wanted signal at the input of the UUT is  $P_{min}$ . This signal level ( $P_{min}$ ) is increased by the value provided in note 2 of the applicable table corresponding to the receiver category and type of equipment.

Step 4:

The blocking signal at the UUT is set to the level provided in the table corresponding to the receiver category and type of equipment.

If the performance criteria as specified in clause 4.3.1.12.3 or clause 4.3.2.11.3 are met then proceed to step 6.

**Step 5:**

If the performance criteria as specified in clause 4.3.1.12.3 or clause 4.3.2.11.3 is not met, step 3 and step 4 shall be repeated after that the frequency of the blocking signal set in step 2 has been increased with a value equal to the Occupied Channel Bandwidth except:

- For the blocking frequency 2 380 MHz, where this frequency offset shall be less than or equal to 10 MHz. If this frequency offset is more than 7 MHz, the level of the wanted signal shall be increased by 3 dB.
- For the blocking frequency 2 503,5 MHz, where this frequency offset shall be less than or equal to 10 MHz. If this frequency offset is more than 7 MHz, the level of the wanted signal shall be decreased by 3 dB.

If the performance criteria as specified in clause 4.3.1.12.3 or clause 4.3.2.11.3 is still not met, step 3 and step 4 shall be repeated after that the frequency of the blocking signal set in step 2 has been decreased with a value equal to the Occupied Channel Bandwidth except:

- For the blocking frequency 2 380 MHz, where this frequency offset shall be less than or equal to 10 MHz. If this frequency offset is more than 7 MHz, the level of the wanted signal shall be decreased by 3 dB.
- For the blocking frequency 2 503,5 MHz, where this frequency offset shall be less than or equal to 10 MHz. If this frequency offset is more than 7 MHz, the level of the wanted signal shall be increased by 3 dB.

If the performance criteria as specified in clause 4.3.1.12.3 or clause 4.3.2.11.3 is still not met, the UUT fails to comply with the Receiver Blocking requirement and step 6 and step 7 are no longer required.

It shall be recorded in the test report whether the shift of blocking frequencies as described in the present step was used.

**Step 6:**

Repeat step 4 and step 5 for each remaining combination of frequency and level for the blocking signal as provided in the table corresponding to the receiver category and type of equipment.

**Step 7**

For non-FHSS equipment, repeat step 2 to step 6 with the UUT operating at the highest operating channel on which the blocking test has to be performed (see clause 5.4.11.1).

**Step 8**

It shall be assessed and recorded in the test report whether the UUT complies with the Receiver Blocking requirement.

Keep the EUT on the lowest and highest channel working mode.

If the equipment can be configured to operate with different Nominal Channel Bandwidths (e.g. 20 MHz and 40 MHz) and different data rates, then the combination of the smallest channel bandwidth and the lowest data rate for this channel bandwidth which still allows the equipment to operate as intended shall be used.

Remark:

Test channel: 2412MHz, 2472MHz for 802.11b

### 5.8.4 TEST RESULTS

Test Date (yy-mm-dd): 2021-08-06

Test environment: Normal condition:

Temp: 23.4°C, Humid:49%

TestMode	Antenna	Channel	Wanted signal[dBm]	Freq.[M Hz]	CW [dBm]	PER[ %]	Limit[ %]	Verdict
802.11b	Ant1	2412	-71	2300	-31	0.60	≤10	PASS
			-71	2330	-31	0.40	≤10	PASS
			-71	2360	-31	0.40	≤10	PASS
			-65	2380	-31	0.20	≤10	PASS
		2472	-65	2504	-31	2.00	≤10	PASS
			-71	2524	-31	1.70	≤10	PASS
			-71	2584	-31	2.10	≤10	PASS
			-71	2674	-31	2.10	≤10	PASS

#### Test screenshots

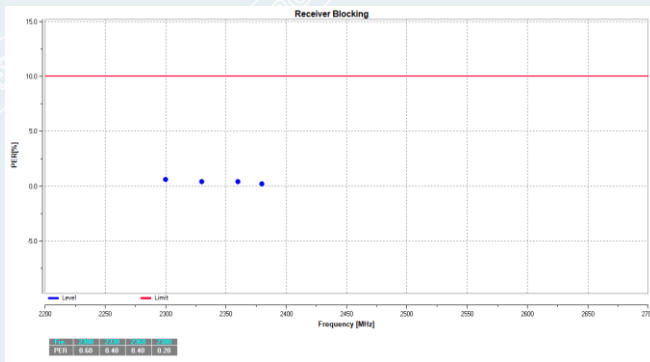

11b\_2412

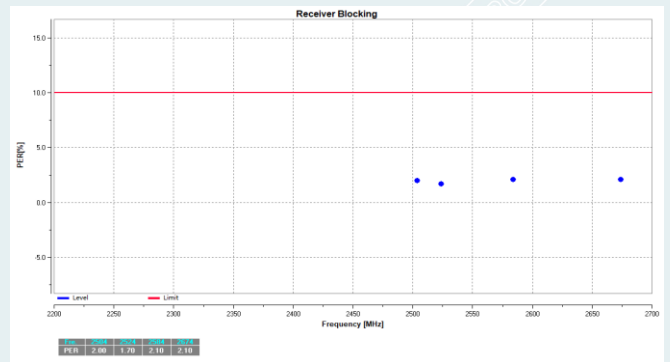

11b\_2472

## 6 APPENDIX A. PHOTOGRAPH OF THE TEST CONNECTION DIAGRAM

Below 1GHz:

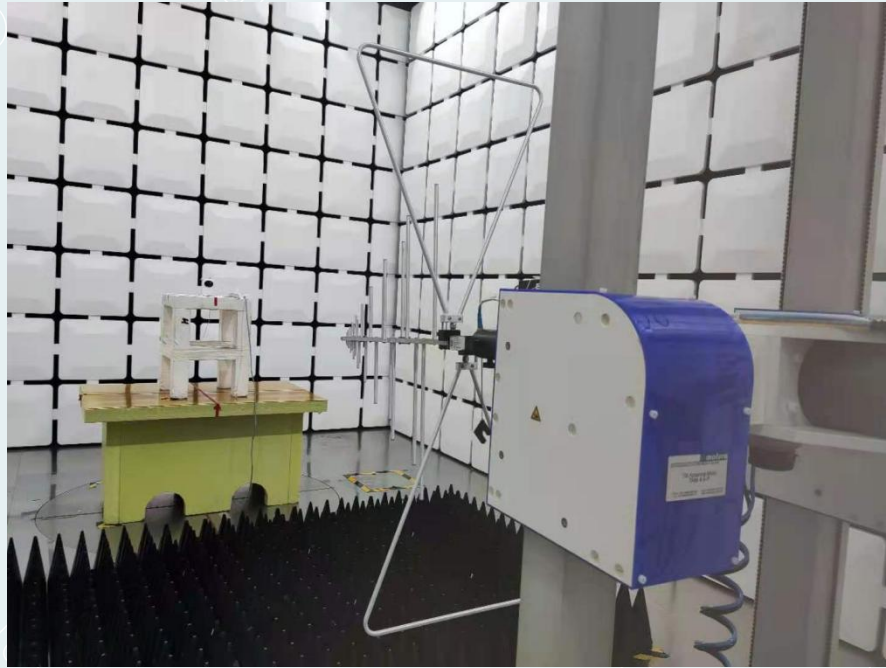

Above 1GHz:

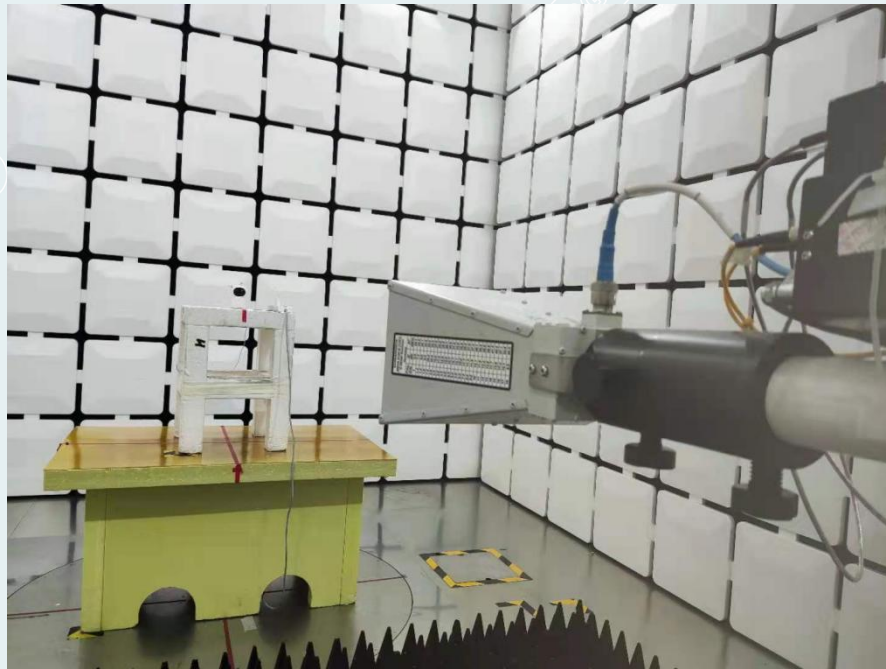

## 7 APPENDIX B. PHOTOGRAPH OF THE EUT

Please refer to the attached document E20210426746801-1-EUT Photo.

-----This is the last page of the report. -----