

# Lumi United Technology Co., Ltd.

## CE TEST REPORT

**SCOPE OF WORK:**

Article 3.2 of RE directive (2014/53/EU) – RF report

**Model:**  
SSM-U02

**REPORT NUMBER:**  
200700673SHA-001

**ISSUE DATE:**  
August 28, 2020

**DOCUMENT CONTROL NUMBER:**  
TTRF300328-02\_V1  
© 2018 Intertek



**Applicant** : Lumi United Technology Co., Ltd.  
8th Floor, JinQi Wisdom Valley, No.1 Tangling Road, Liuxian Ave,  
Taoyuan Residential District, Nanshan District, Shenzhen. China

**Manufacturer** : Same as applicant

**Manufacturing site** : CHINAGPS CO., LTD.  
F1-3, Manufacturing Center, No.1, SEG Navigation Science and  
Technology Park, Baolong Industrial City, Longgang District,  
Shenzhen P.R.China

### Summary

The equipment complies with the requirements according to the following standard(s) or Specification:

**EN 300 328 V2.2.2:** Wideband transmission systems; Data transmission equipment operating in the 2,4 GHz band; Harmonised Standard for access to radio spectrum

**PREPARED BY:**

**REVIEWED BY:**



Project Engineer  
Eric Li

Reviewer  
Wakeyou Wang

This report is for the exclusive use of Intertek's Client and is provided pursuant to the agreement between Intertek and its Client. Intertek's responsibility and liability are limited to the terms and conditions of the agreement. Intertek assumes no liability to any party, other than to the Client in accordance with the agreement, for any loss, expense or damage occasioned by the use of this report. Only the Client is authorized to permit copying or distribution of this report and then only in its entirety. Any use of the Intertek name or one of its marks for the sale or advertisement of the tested material, product or service must first be approved in writing by Intertek. The observations and test results in this report are relevant only to the sample tested. This report by itself does not imply that the material, product, or service is or has ever been under an Intertek certification program.

## Contents

<b>REVISION HISTORY.....</b>	<b>5</b>
<b>MEASUREMENT RESULT SUMMARY .....</b>	<b>6</b>
<b>1 GENERAL INFORMATION .....</b>	<b>7</b>
1.1 DESCRIPTION OF EQUIPMENT UNDER TEST (EUT) .....	7
1.2 RF TECHNICAL INFORMATION .....	8
1.3 DESCRIPTION OF TEST FACILITY .....	9
<b>2 TEST SPECIFICATIONS.....</b>	<b>10</b>
2.1 STANDARDS OR SPECIFICATION .....	10
2.2 MODE OF OPERATION DURING THE TEST.....	10
2.3 TEST PERIPHERALS USED .....	10
2.4 RECORD OF NORMAL AND EXTREME TEST CONDITIONS .....	11
2.5 INSTRUMENT LIST .....	12
2.6 MEASUREMENT UNCERTAINTY .....	14
<b>3 RF OUTPUT POWER .....</b>	<b>15</b>
3.1 LIMIT .....	15
3.2 BLOCK DIAGRAM OF TEST SETUP .....	15
3.2.1 For conducted method .....	15
3.2.2 For radiated method .....	16
3.3 TEST CONDITIONS AND TEST METHOD .....	17
3.4 TEST RESULT.....	18
<b>4 POWER SPECTRAL DENSITY .....</b>	<b>19</b>
4.1 LIMIT .....	19
4.2 BLOCK DIAGRAM OF TEST SETUP .....	19
4.2.1 For conducted method .....	19
4.2.2 For radiated method .....	19
4.3 TEST CONDITIONS AND TEST METHOD .....	20
4.4 TEST RESULT.....	20
<b>5 DUTY CYCLE, TX-SEQUENCE, TX-GAP .....</b>	<b>21</b>
5.1 LIMIT .....	21
5.2 BLOCK DIAGRAM OF TEST SETUP .....	21
5.2.1 For conducted method .....	21
5.2.2 For radiated method .....	22
5.3 TEST CONDITIONS AND TEST METHOD .....	22
5.4 TEST RESULT.....	23
<b>6 MEDIUM UTILISATION (MU) FACTOR .....</b>	<b>24</b>
6.1 LIMIT .....	24
6.2 CALCULATION PROCEDURE .....	24
6.3 TEST RESULT.....	24
<b>7 OCCUPIED CHANNEL BANDWIDTH .....</b>	<b>25</b>
7.1 LIMIT .....	25
7.2 BLOCK DIAGRAM OF TEST SETUP .....	25
7.2.1 For conducted method .....	25
7.2.2 For radiated method .....	26

**TEST REPORT**

7.3 TEST CONDITIONS AND TEST METHOD ..... 26

7.4 TEST RESULT..... 27

**8 TRANSMITTER UNWANTED EMISSIONS IN THE OUT-OF-BAND DOMAIN ..... 29**

8.1 LIMIT ..... 29

8.2 BLOCK DIAGRAM OF TEST SETUP ..... 29

    8.2.1 For conducted method ..... 29

    8.2.2 For radiated method ..... 30

8.3 TEST CONDITIONS AND TEST METHOD ..... 31

8.4 TEST RESULT..... 32

**9 TRANSMITTER UNWANTED EMISSIONS IN THE SPURIOUS DOMAIN ..... 33**

9.1 LIMIT ..... 33

9.2 BLOCK DIAGRAM OF TEST SETUP ..... 33

    9.2.1 For conducted method ..... 33

    9.2.2 For radiated method ..... 34

9.3 TEST CONDITIONS AND TEST METHOD ..... 35

9.4 TEST RESULT..... 36

**10 ADAPTIVITY ..... 38**

10.1 LIMIT ..... 38

10.2 BLOCK DIAGRAM OF TEST SETUP ..... 39

    10.2.1 For conducted method ..... 39

    10.2.2 For radiated method ..... 39

10.3 TEST CONDITIONS AND TEST METHOD..... 40

10.4 TEST RESULT ..... 40

**11 RECEIVER BLOCKING ..... 41**

11.1 LIMIT ..... 41

11.2 BLOCK DIAGRAM OF TEST SETUP ..... 43

    11.2.1 For conducted method ..... 43

    11.2.2 For radiated method ..... 43

11.3 TEST CONDITIONS AND TEST METHOD..... 44

11.4 TEST RESULT ..... 45

**12 RECEIVER SPURIOUS EMISSION ..... 46**

12.1 LIMIT ..... 46

12.2 BLOCK DIAGRAM OF TEST SETUP ..... 46

    12.2.1 For conducted method ..... 46

    12.2.2 For radiated method ..... 47

12.3 TEST CONDITIONS AND TEST METHOD..... 48

12.4 TEST PROTOCOL..... 49

**13 GEO-LOCATION CAPABILITY ..... 50**

13.1 APPLICABILITY..... 50

13.2 REQUIREMENTS..... 50

13.3 DESCRIPTION ..... 50

**APPENDIX I: PHOTOGRAPH OF EQUIPMENT UNDER TEST ..... 51**

**Revision History**

<b>Report No.</b>	<b>Version</b>	<b>Description</b>	<b>Issued Date</b>
200700673SHA-001	Rev. 01	Initial issue of report	July 3, 2020
200700673SHA-001	Rev. 02	Client update the rating voltage 250V~ to 100-250V~, we add the 120V~ data	August 28, 2020

## Measurement result summary

TEST ITEM	TEST RESULT	NOTE
RF Output Power	Pass	
Power Spectral Density	Pass	
Duty Cycle, Tx-sequence, Tx-gap	NA	Only for non-adaptive equipment
Medium Utilization (MU) factor	NA	Only for non-adaptive equipment
Occupied Channel Bandwidth	Pass	
Transmitter unwanted emissions in the out-of-band domain	Pass	
Transmitter unwanted emissions in the spurious domain	Pass	
Adaptivity	NA	Not applied for equipment with e.i.r.p. less than 10dBm
Receiver Blocking	Pass	
Receiver spurious emission	Pass	
Geo-location capability	NA	

Notes: 1: NA =Not Applicable

2. Determination of the test conclusion is based on IEC Guide 115 in consideration of measurement uncertainty.

3. Additions, Deviations and Exclusions from Standards: None.

## 1 GENERAL INFORMATION

### 1.1 Description of Equipment Under Test (EUT)

Product name : Single Switch Module T1 (No Neutral)

Type/Model : SSM-U02

Description of EUT : EUT is a Single Switch Module with Zigbee function. We test it and list the worst data in this report.

Rating : 100-250VAC, Max.5A, 50/60Hz

Hardware version : /

Software version : /

Sample received date : Jun 11, 2020

Date of test : Jun 11~Jun 28, 2020

1.2 RF Technical Information

No.	Protocol	Channel Frequency (MHz)	Channel No.
1	Zigbee	2405 - 2480	16

Modulation: O-QPSK

Antenna information:

No.	Antenna Type	Gain (dBi)	Note
1	External Integral Antenna	2.0	-

Equipment types

Modulation types:

Frequency Hopping Spread Spectrum (FHSS) equipment, further referred to as FHSS equipment.

Other types of Wideband Data Transmission equipment, further referred to as non-FHSS equipment (e.g. DSSS, OFDM, etc.).

Adaptive and non-adaptive equipment:

Non-Adaptive Equipment:

Adaptive Equipment without the possibility to switch to a non-adaptive mode:

Adaptive Equipment which can also operate in non-adaptive mode

Receiver categories:

Receiver category 1:  
Adaptive equipment with a maximum RF output power greater than 10 dBm e.i.r.p.

Receiver category 2:  

- Non-adaptive equipment with a Medium Utilization (MU) factor greater than 1 % and less than or equal to 10 % (irrespective of the maximum RF output power); or
- equipment (adaptive or non-adaptive) with a maximum RF output power greater than 0 dBm e.i.r.p. and less than or equal to 10 dBm e.i.r.p.

Receiver category 3:  

- Non-adaptive equipment with a maximum Medium Utilization (MU) factor of 1 % (irrespective of the maximum RF output power) or
- equipment (adaptive or non-adaptive) with a maximum RF output power of 0 dBm e.i.r.p.

Channel	Frequency	Channel	Frequency	Channel	Frequency
11	2405 MHz	17	2435 MHz	23	2465 MHz
12	2410 MHz	18	2440 MHz	24	2470 MHz
13	2415 MHz	19	2445 MHz	25	2475 MHz
14	2420 MHz	20	2450 MHz	26	2480 MHz
15	2425 MHz	21	2455 MHz	-	-
16	2430 MHz	22	2460 MHz	-	-



**1.3 Description of Test Facility**

Name : Intertek Testing Services Shanghai  
Address : Building 86, No. 1198 Qinzhou Road(North), Shanghai 200233, P.R.  
China  
Telephone : 86 21 61278200  
Telefax : 86 21 54262353

The test facility is recognized, certified, or accredited by these organizations :

- CNAS Accreditation Lab  
Registration No. CNAS L0139
- FCC Accredited Lab  
Designation Number: CN1175
- IC Registration Lab  
CAB identifier.: CN0051
- VCCI Registration Lab  
Registration No.: R-14243, G-10845, C-14723, T-12252
- A2LA Accreditation Lab  
Certificate Number: 3309.02

**Subcontractor:**

<input checked="" type="checkbox"/>	Name	Waltek Services Testing Group Limited
	Address	2/F,2nd Building, Sunlink International Machinery City, Chencun Town, Shunde District, Foshan 528313, Guangdong, China
	Telephone	+86-757-23811398
	CNAS No	L3110

## 2 TEST SPECIFICATIONS

### 2.1 Standards or specification

**EN 300 328 V2.2.2:** Wideband transmission systems; Data transmission equipment operating in the 2,4 GHz band; Harmonised Standard for access to radio spectrum

### 2.2 Mode of operation during the test

While testing transmitting mode of EUT, the continuously transmission was applied by following software.

Software name	Manufacturer	Version	Supplied by
SecureCRT	-	-	Client

The lowest, middle and highest channel were tested as representatives.

Frequency Band (MHz)	Modulation	Lowest (L) (MHz)	Middle (M) (MHz)	Highest (H) (MHz)
2400-2483.5	O-QPSK	2405	2445	2480

### 2.3 Test peripherals used

Item No	Description	Band and Model	S/No
1	Laptop computer	DELL, 5480	NA

**2.4 Record of normal and extreme test conditions**

Test Item	Normal Temperature (°C)	Relative Humidity (%)
RF Output Power	25	53
Duty Cycle, Tx-sequence, Tx-gap		
Medium Utilization (MU) factor		
Occupied Channel Bandwidth		
Transmitter unwanted emissions in the out-of-band domain		
Hopping Frequency Separation, Accumulated Transmit time, Frequency Occupation and Hopping Sequence		
Adaptivity		
Receiver Blocking	23	52
Transmitter unwanted emissions in the spurious domain		
Receiver spurious emission		

Extremes of the operating temperature range as declared by the manufacturer
0°C to 35 °C

Abbreviations	
Tnom	Normal Temperature
Tmin	Extreme Low Temperature
Tmax	Extreme High Temperature

2.5 Instrument list

Conducted Emission						
Item	Equipment	Manufacturer	Model No.	Serial No.	Last Calibration Date	Valid
1	EMI Test Receiver	R&S	ESCI	100947	2019-09-17	2020-09-16
2	LISN	R&S	ENV216	100115	2019-09-17	2020-09-16
3	Cable	Top	TYPE16(3.5M)	-	2019-09-17	2020-09-16
3m Semi-anechoic Chamber for Radiation						
Item	Equipment	Manufacturer	Model No.	Serial No.	Last Calibration Date	Valid
1	Spectrum Analyzer	R&S	FSP30	100091	2020-04-20	2021-04-19
2	Broad-band Horn Antenna	SCHWARZBECK	BBHA 9120 D	667	2020-04-25	2021-04-24
3	Broadband Preamplifier	COMPLIANCE DIRECTION	PAP-1G18	2004	2020-04-20	2021-04-19
4	Coaxial Cable (above 1GHz)	ZT26-NJ-NJ-8M/FA	1GHz-18GHz	NA	2020-04-20	2021-04-19
5	Test Receiver	R&S	ESCI	101296	2020-04-20	2021-04-19
6	Trilog Broadband Antenna	SCHWARZBECK	VULB9160	9160-3325	2020-04-25	2021-04-24
7	Amplifier	ANRITSU	MH648A	M43381	2020-04-20	2021-04-19
8	Cable	HUBER+SUHNER	CBL2	525178	2020-04-20	2021-04-19
Flicker Measuring System						
Item	Equipment	Manufacturer	Model No.	Serial No.	Last Calibration Date	Valid
1	Digital Power Analyzer	SCHAFFNER	CCN 1000-1	72625	2020-04-20	2021-04-19
2	Power Source	SCHAFFNER	NSG 1007	58477	2020-04-20	2021-04-19
Electrostatic Discharge						
Item	Equipment	Manufacturer	Model No.	Serial No.	Last Calibration Date	Valid
1	Electrostatic Discharge Simulator	SCHLODER	SESD 216	606144	2020-04-24	2021-04-23
Radio-frequency electromagnetic fields						
Item	Equipment	Manufacturer	Model No.	Serial No.	Last Calibration Date	Valid
1	Signal Generator	R&S	SMB100A	105942	2019-09-17	2020-09-16
2	RF Power Amplifier	BONN Elektronik	BLWA0830-160/100/40D	128740	2019-09-17	2020-09-16
3	Gestockte Breitband (S tacked ) Log.-per.Antenna	SCHWARZBECK	STLP9128D	043	2019-09-17	2020-09-16

4	Power Meter	R&S	NRP2	102031	2020-04-20	2021-04-19
5	Amplifier	NJNT	NTWPAS-2560025	2560025	2020-04-20	2021-04-19
6	Broad-band Horn Antenna	SCHWARZBECK	BBHA 9120 D	667	2020-04-28	2021-04-27

**Surge, EFT, Voltage dips and Interruption**

Item	Equipment	Manufacturer	Model No.	Serial No.	Last Calibration Date	Valid
1	All Modules Generator	SCHAFFNER	6150	34579	2019-09-17	2020-9-16
2	Capacitive Coupling Clamp	SCHAFFNER	CDN 8014	25311	2019-09-17	2020-9-16
3	Signal and Data Line Coupling Network	SCHAFFNER	CDN 117	25627	2019-09-17	2020-9-16
4	AC Power Supply	HENGYUAN	DTDGC-4	-	2019-09-17	2020-9-16

**Conducted Immunity**

Item	Equipment	Manufacturer	Model No.	Serial No.	Last Calibration Date	Valid
1	RF Generator	TESEQ	NSG4070	25781	2019-09-17	2020-9-16
2	CDN M-Type	TESEQ	CDN M016	25112	2019-09-17	2020-9-16
3	EM-Clamp	TESEQ	KEMZ 801	25453	2019-09-17	2020-9-16
4	Attenuator 6dB	TESEQ	ATN6050	25376	2019-09-17	2020-9-16

**RF Test**

Item	Equipment	Manufacturer	Model No.	Serial No.	Last Calibration Date	Valid
1	EXA Signal Analyzer	Malaysia Keysight	N9010A	MY50520207	2020-04-20	2021-04-19
2	ESG VECTOR SIGNAL GENERATOR	Malaysia Keysight	E4438C	MY45092536	2020-04-20	2021-04-19
3	EXG Analog Signal Generator	Malaysia Keysight	N5171B	MY53050845	2019-09-17	2020-09-16
4	Signal Generator	Agilent	N5182A	MY46240814	2019-09-17	2020-09-16
5	USB Wideband Power Sensor	Malaysia Keysight	U2021XA	SG54400003	2019-09-17	2020-09-16
6	Universal Radio Communication Tester	R&S	CMW500	116543	2019-09-17	2020-09-16

## 2.6 Measurement Uncertainty

Parameter	Uncertainty
Occupied Channel Bandwidth	±5 %
RF output power, conducted	±1.5dB
Power Spectral Density, conducted	±3dB
Unwanted Emissions, conducted	±3dB
All emissions, radiated	±6dB
Time	±5%
Duty Cycle	±5%
Temperature	±1°C
Humidity	±5%
DC and low frequency voltages	±3%
Radiated Emission(30MHz~1GHz)	±5.03dB
Radiated Emission(1GHz~18GHz)	±5.47dB

### 3 RF output power

Test result: Pass

#### 3.1 Limit

Mode	Limit	
	(mW)	(dBm)
Adaptive	100	20
Non-adaptive	100	20

Note: the limit for non-adaptive device is declared by the applicant.

#### 3.2 Block Diagram of Test Setup

##### 3.2.1 For conducted method

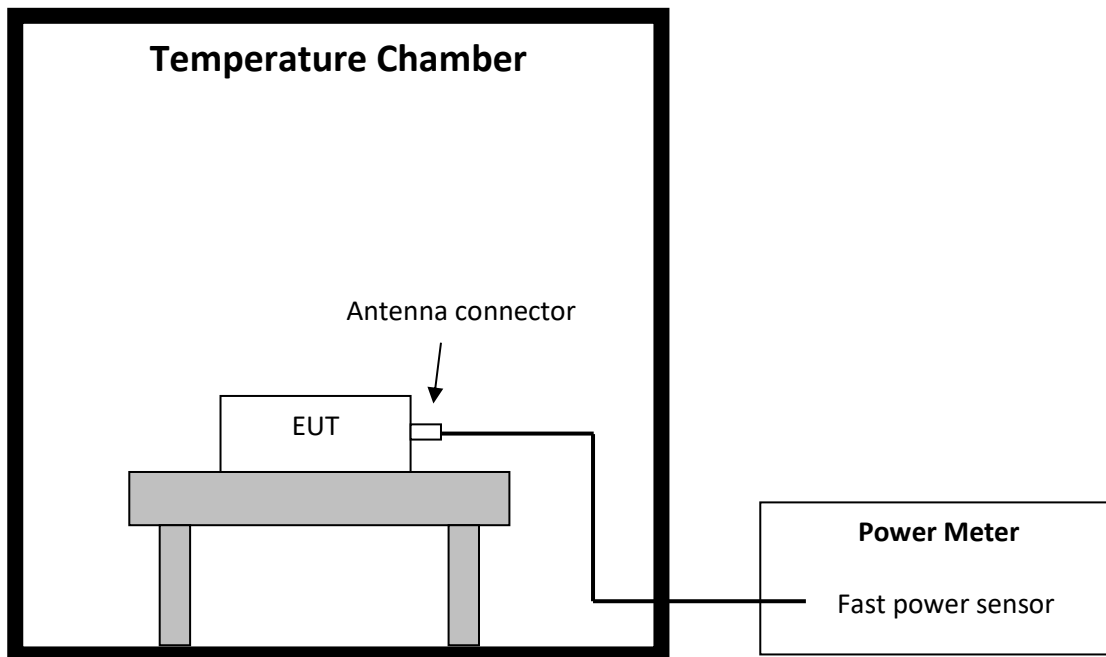

3.2.2 For radiated method

Step one

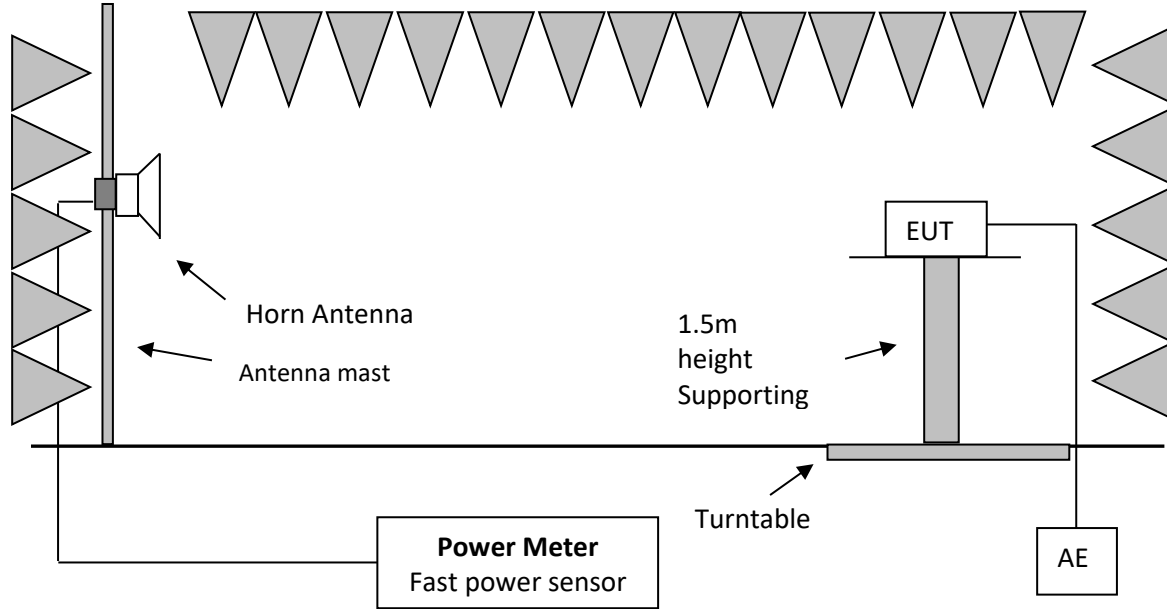

Step two

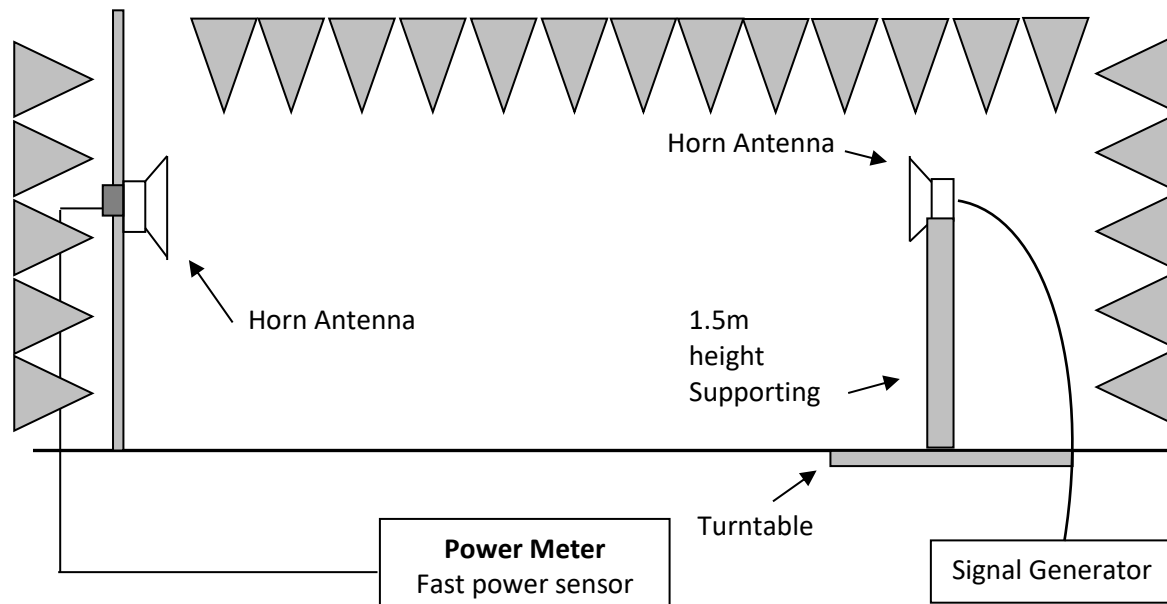



Step three

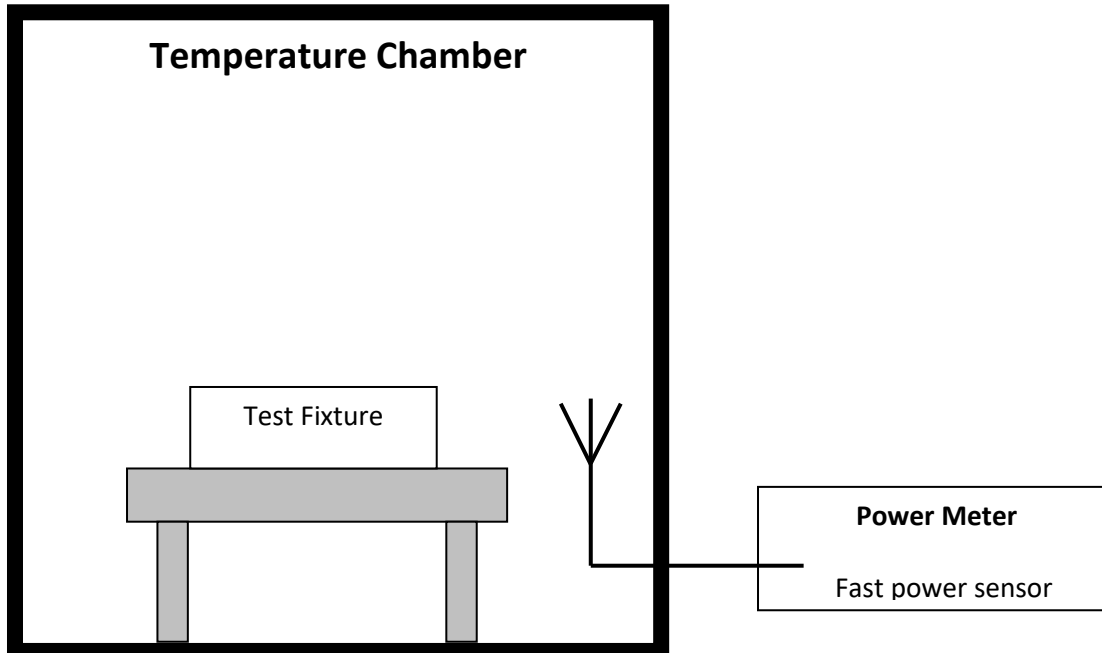

### 3.3 Test Conditions and Test Method

The measurements shall be performed at both normal environmental conditions and at the extremes of the operating temperature range.

The equipment shall be operated under its worst case configuration (for example modulation, bandwidth, data rate, power) with regards to the requirement being tested.

For equipment using FHSS modulation, the measurements shall be performed during normal operation (hopping) and the equipment is assumed to have no blacklisted frequencies (operating on all hopping positions).

For equipment using wide band modulations other than FHSS, the measurement shall be performed at the lowest, the middle, and the highest channel on which the equipment can operate.

For conducted method

The EUT was connected to the power meter directly. Please refer to EN 300 328 Clause 5.4.2.2.1 for test method.

For radiated method

The measurement was applied in a semi-anechoic chamber. Please refer to EN 300 328 Clause 5.4.2.2.2 and for test method.

### 3.4 Test Result

Mode	Channel	Condition	EIRP (dBm)	Limit (dBm)	Pass/Fail
Zigbee	L	Tnom	9.12	20	Pass
		Tmin	9.21		
		Tmax	9.20		
	M	Tnom	9.32	20	Pass
		Tmin	9.39		
		Tmax	9.38		
	H	Tnom	9.46	20	Pass
		Tmin	9.52		
		Tmax	9.50		

## 4 Power Spectral Density

Test result: Pass

### 4.1 Limit

For equipment using wide band modulations other than FHSS, the maximum Power Spectral Density is limited to 10 dBm per MHz.

### 4.2 Block Diagram of Test Setup

#### 4.2.1 For conducted method

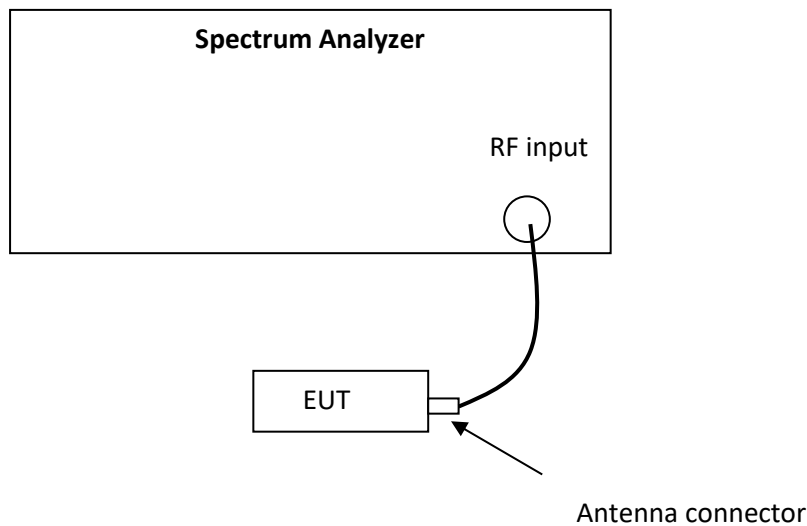

#### 4.2.2 For radiated method

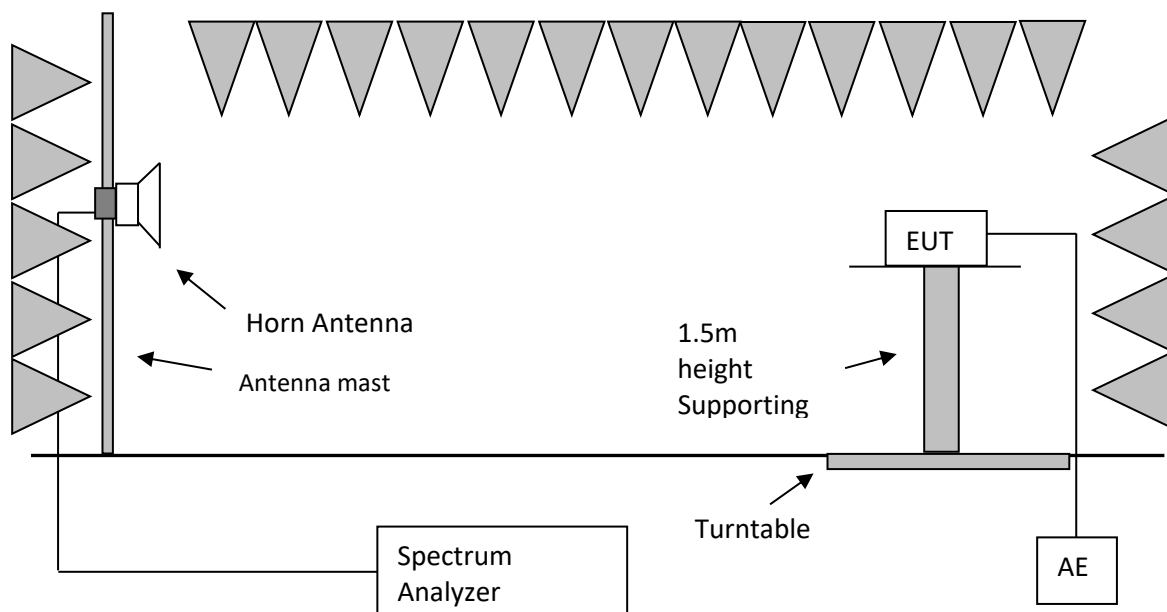

### 4.3 Test Conditions and Test Method

These measurements shall only be performed at normal test conditions.

The measurement shall be repeated for the equipment being configured to operate at the lowest, the middle, and the highest frequency of the stated frequency range. These frequencies shall be recorded.

For conducted method

The EUT was connected to the spectrum analyzer directly. Please refer to EN 300 328 Clause 5.4.3.2.1 for test method.

For radiated method

The measurement was applied in a semi-anechoic chamber. Please refer to EN 300 328 Clause 5.4.3.2.2 for test method.

### 4.4 Test Result

Mode	Channel	Power Density (dBm/MHz)	Limit (dBm/MHz)	Pass/Fail
Zigbee	L	7.84	10	Pass
	M	8.09	10	Pass
	H	8.18	10	Pass

## 5 Duty Cycle, Tx-sequence, Tx-gap

Test result: NA

### 5.1 Limit

Mode	Maximum Duty Cycle (%)	Maximum Tx-sequence (ms)	Minimum Tx-gap (ms)
Non-adaptive	100	10	3.5

Note: 1. The limit for maximum duty cycle is declared by the applicant.  
 2. This test is not applied to the device / mode with EIRP less than 10dBm.

### 5.2 Block Diagram of Test Setup

#### 5.2.1 For conducted method

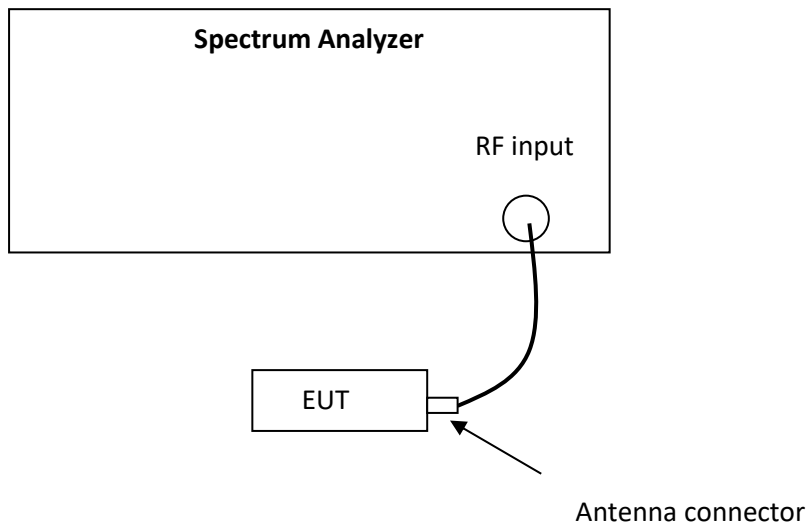

5.2.2 For radiated method

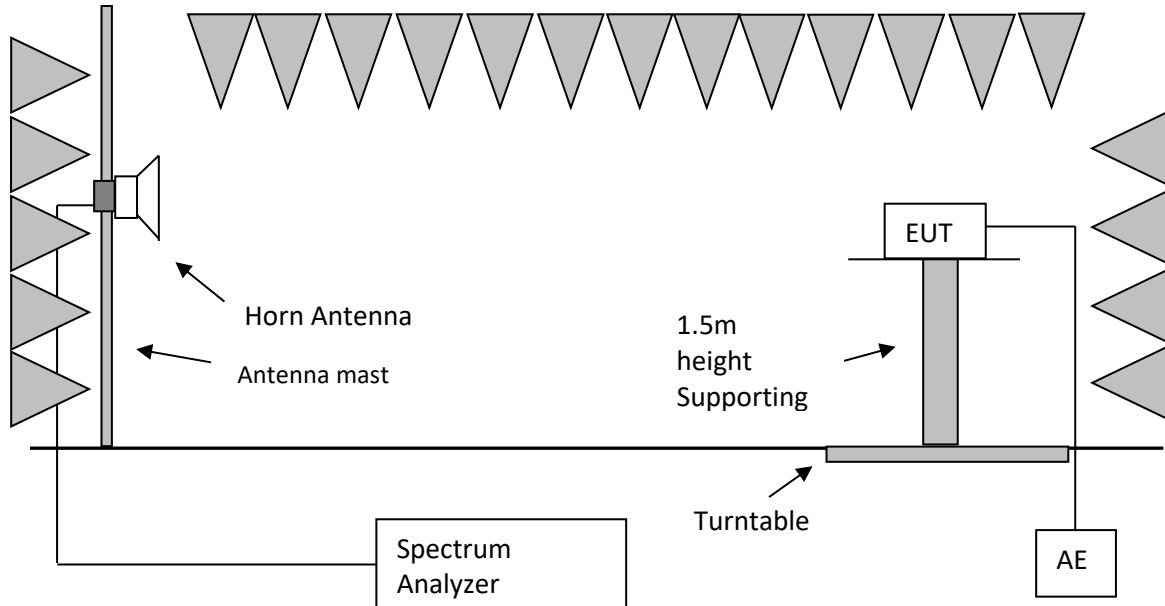

**5.3 Test Conditions and Test Method**

These measurements shall only be performed at normal test conditions.

The equipment shall be operated under its worst case configuration (for example modulation, bandwidth, data rate, power) with regards to the requirement being tested.

For equipment using FHSS modulation, the measurements shall be performed during normal operation (hopping) and the equipment is assumed to have no blacklisted frequencies (operating on all hopping positions).

For equipment using wide band modulations other than FHSS, the measurement shall be performed at the lowest, the middle, and the highest channel on which the equipment can operate. These frequencies shall be recorded.

For conducted method

The EUT was connected to the power meter directly. Please refer to EN 300 328 Clause 5.4.2.2.1 for test method.

For radiated method

The measurement was applied in a semi-anechoic chamber. Please refer to EN 300 328 Clause 5.4.2.2.2 and for test method.

5.4 Test Result

Maximum Duty Cycle			
Channel	Observed value (%)	Limit (%)	Pass/Fail
L		100	
M			
H			

Maximum Tx-sequence			
Channel	Observed value (ms)	Limit (ms)	Pass/Fail
L		10	
M			
H			

Minimum Tx-gap			
Channel	Observed value (ms)	Limit (ms)	Pass/Fail
L		3.5	
M			
H			

## 6 Medium Utilisation (MU) factor

Test result: NA

### 6.1 Limit

Mode	Maximum MU factor (%)
Non-adaptive	10

Note: this requirement does not apply for equipment with a maximum declared RF Output power level of less than 10 dBm e.i.r.p. or for equipment when operating in a mode where the RF Output power is less than 10 dBm e.i.r.p.

### 6.2 Calculation Procedure

MU factor = (RF output power / 100 mW) \* Duty Cycle

### 6.3 Test Result

MU factor			
Channel	Calculated value (%)	Limit (%)	Pass/Fail
L		10	
M			
H			



## 7 Occupied Channel Bandwidth

Test result: Pass

### 7.1 Limit

- Occupied channel Bandwidth shall fall within the band 2400-2483.50MHz.
- For non-adaptive equipment using wide band modulations other than FHSS and with e.i.r.p. greater than 10 dBm, the occupied channel bandwidth shall be less than 20 MHz.

### 7.2 Block Diagram of Test Setup

#### 7.2.1 For conducted method

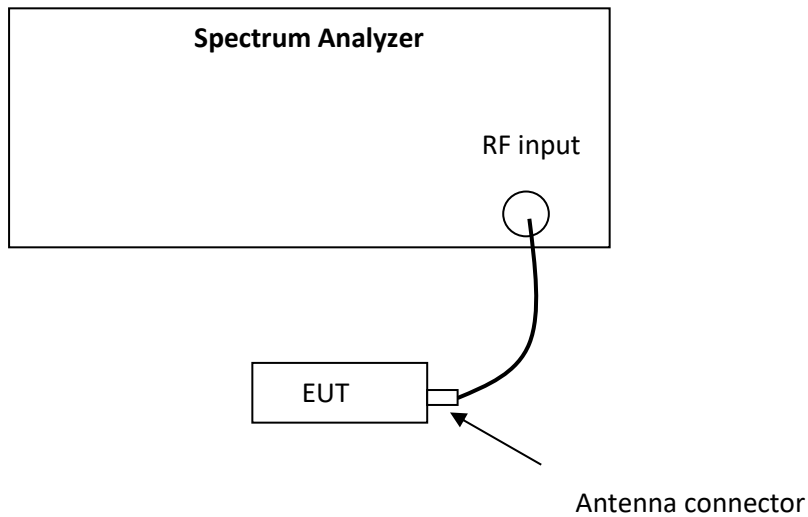

7.2.2 For radiated method

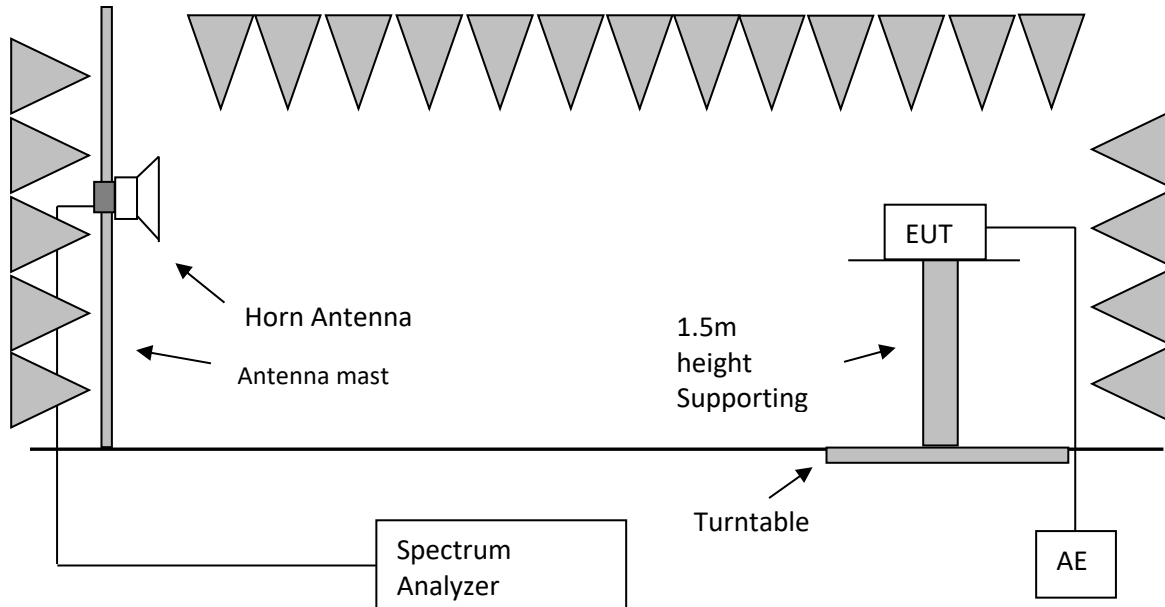

**7.3 Test Conditions and Test Method**

These measurements shall only be performed at normal test conditions.

In case of conducted measurements on smart antenna systems (equipment with multiple transmit chains) measurements need only to be performed on one of the active transmit chains (antenna outputs).

For equipment using FHSS modulation and which have overlapping channels, special software might be required to force the UUT to hop or transmit on a single Hopping Frequency.

The measurement shall be performed only on the lowest and the highest frequency within the stated frequency range. The frequencies on which the tests were performed shall be recorded.

If the equipment can operate with different Nominal Channel Bandwidths (e.g. 20 MHz and 40 MHz), then each channel bandwidth shall be tested separately.

For conducted method

The EUT was connected to the spectrum analyzer directly. Please refer to EN 300 328 Clause 5.4.7.2.1 for test method.

For radiated method

The measurement was applied in a semi-anechoic chamber. Please refer to EN 300 328 Clause 5.4.7.2.2 and for test method.

## 7.4 Test Result

Mode	Channel	99% Bandwidth (MHz)	F <sub>L</sub> at 99% BW (MHz)	F <sub>H</sub> at 99% BW (MHz)	Limit (MHz)	Pass/Fail
Zigbee	L	2.07	2403.96	/	2400 to 2483.5	Pass
	H	2.08	/	2481.03		Pass

99% Bandwidth : 2405MHz

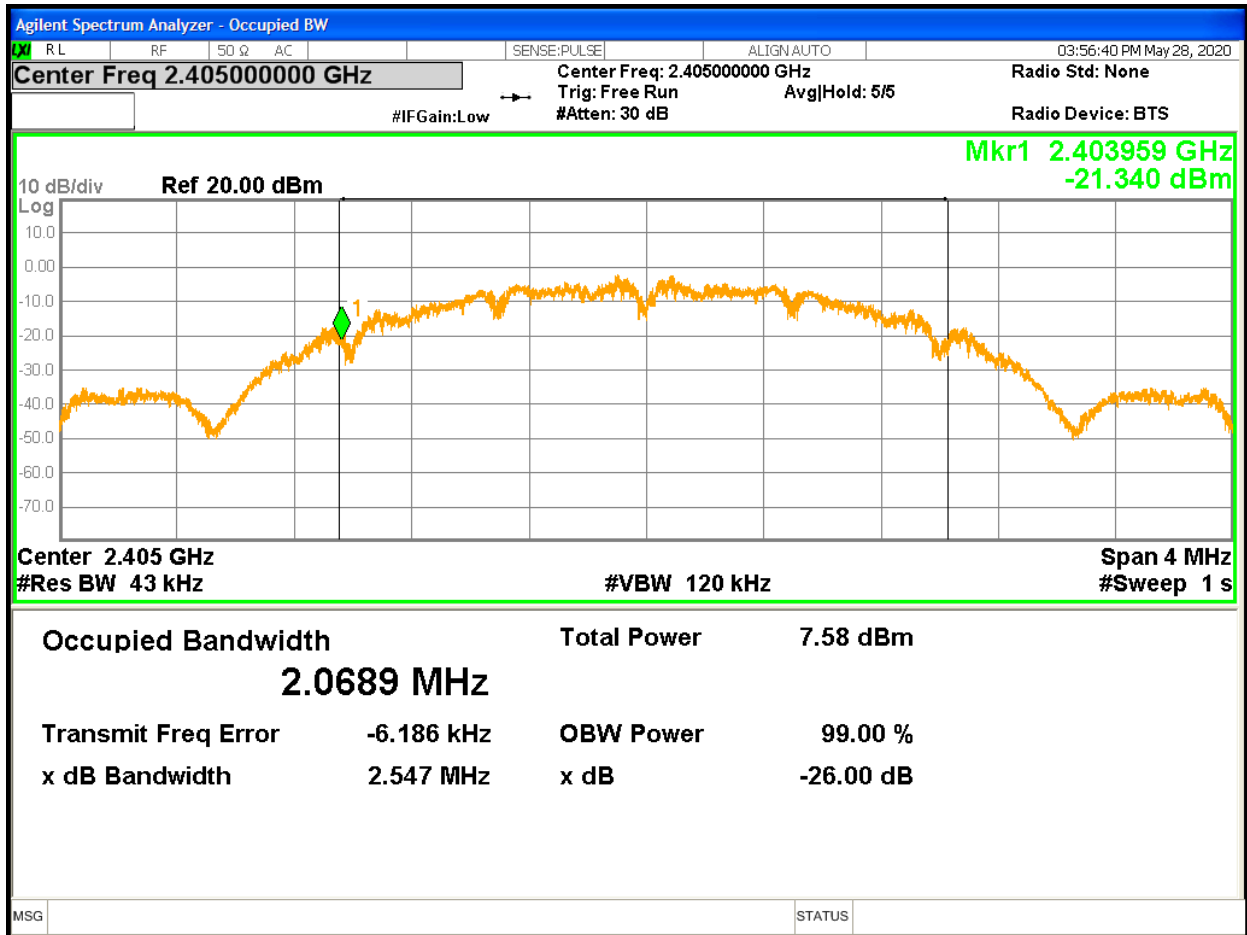

99% Bandwidth : 2480MHz

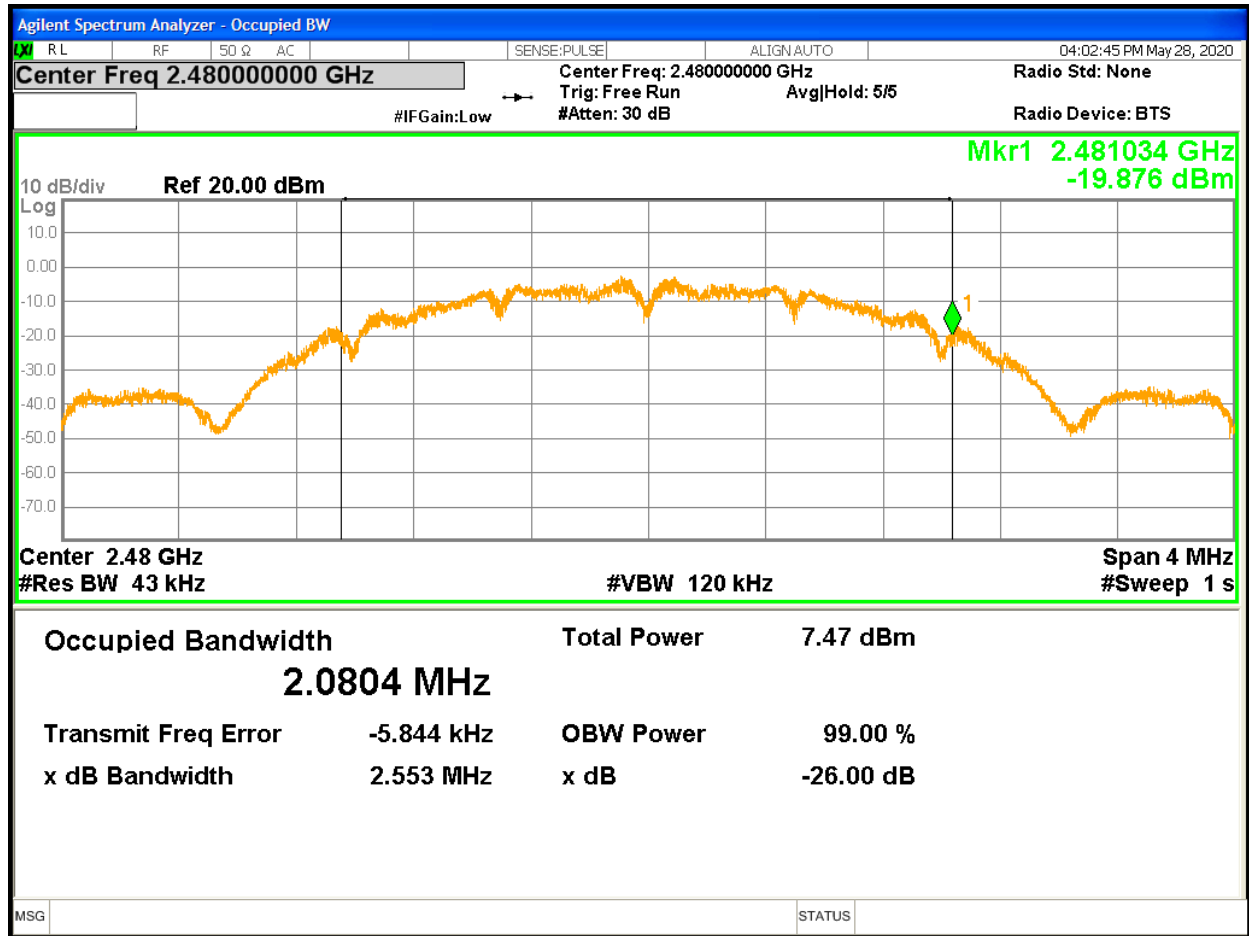

## 8 Transmitter unwanted emissions in the out-of-band domain

Test result: Pass

### 8.1 Limit

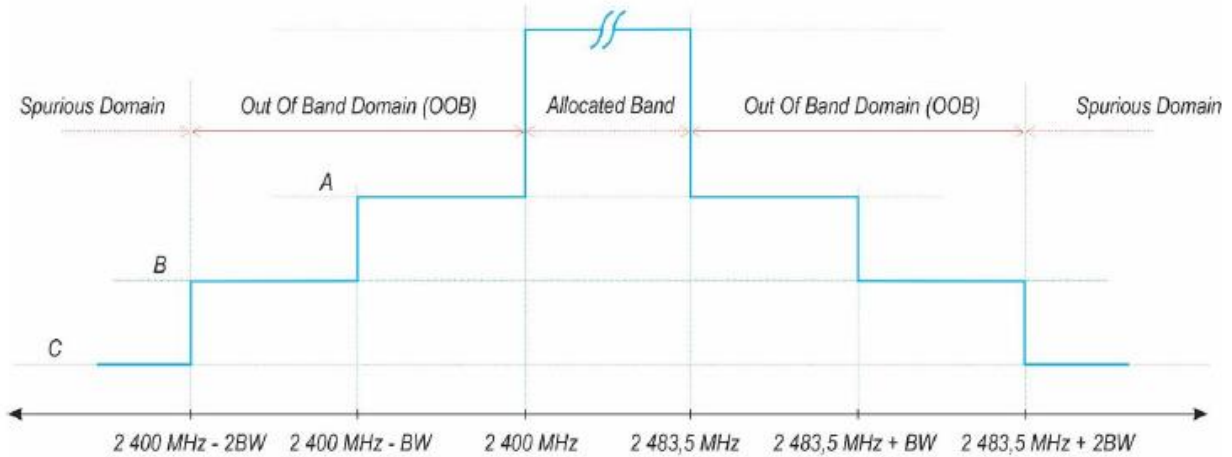

A: -10 dBm/MHz e.i.r.p.  
 B: -20 dBm/MHz e.i.r.p.  
 C: Spurious Domain limits

BW = Occupied Channel Bandwidth in MHz or 1 MHz whichever is greater

### 8.2 Block Diagram of Test Setup

#### 8.2.1 For conducted method

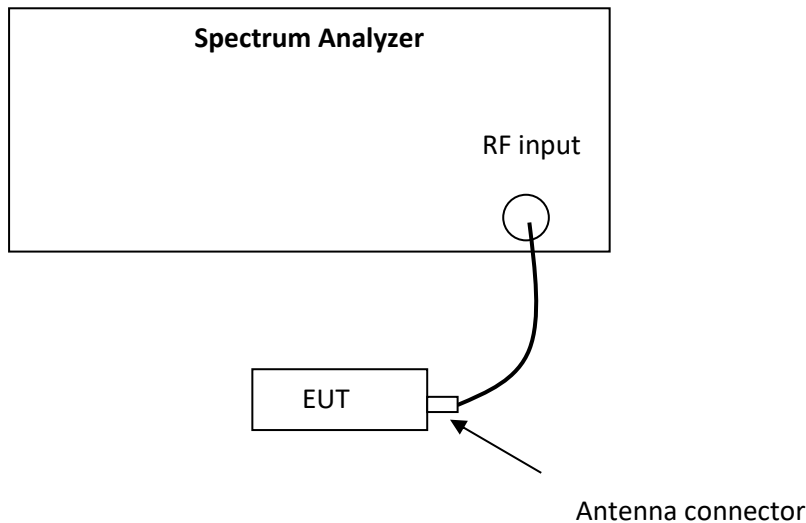

8.2.2 For radiated method

Step one

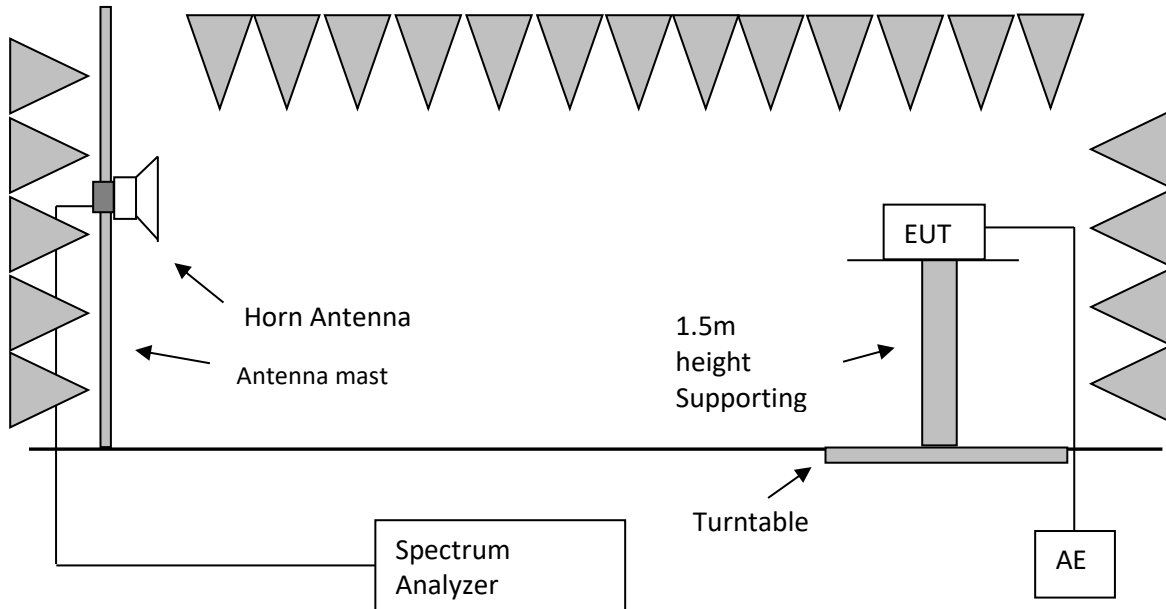

Step two

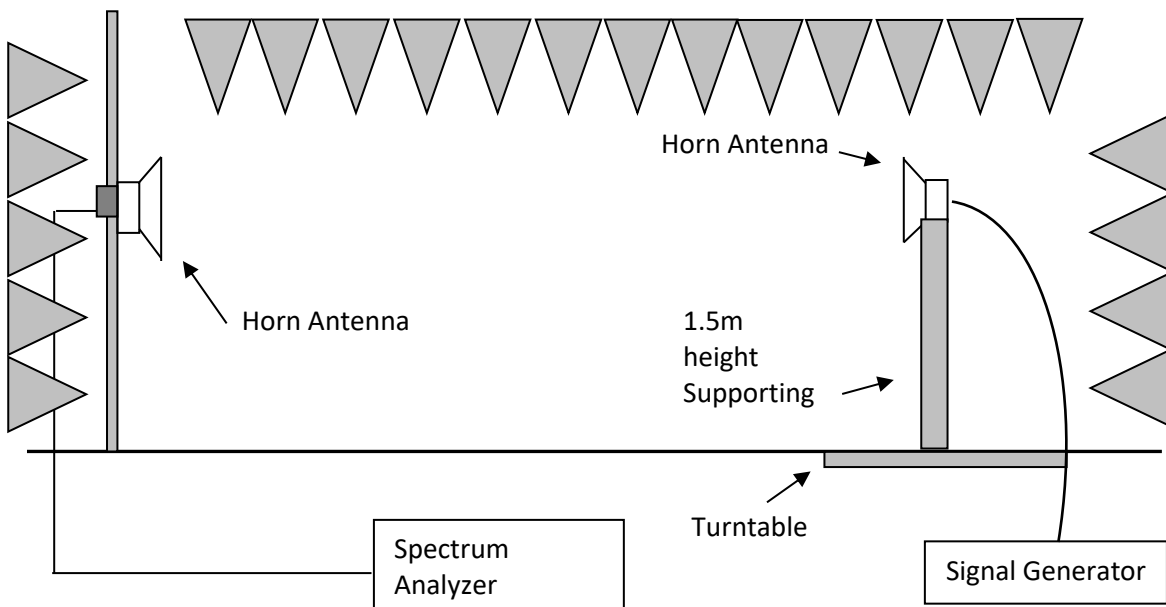

### 8.3 Test Conditions and Test Method

These measurements shall only be performed at normal test conditions.

For equipment using FHSS modulation, the measurements shall be performed during normal operation (hopping).

For equipment using wide band modulations other than FHSS, the measurement shall be performed at the lowest and the highest channel on which the equipment can operate. These operating channels shall be recorded.

The equipment shall be configured to operate under its worst case situation with respect to output power.

If the equipment can operate with different Nominal Channel Bandwidths (e.g. 20 MHz and 40 MHz), then each channel bandwidth shall be tested separately.

For conducted method

The EUT was connected to the spectrum analyzer directly. Please refer to EN 300 328 Clause 5.4.8.2.1 for test method.

For radiated method

The measurement was applied in a semi-anechoic chamber. Please refer to EN 300 328 Clause 5.4.8.2.2 for test method.

## 8.4 Test Result

Mode	Channel	Out-of-band emission			
		Test Frequency (MHz)	OOB Emission (dBm/MHz)	Limit (dBm/MHz)	Pass/Fail
Zigbee	L	2400-BW ~ 2400	-42.22	-10	Pass
		2400-2BW ~ 2400-BW	-53.15	-20	Pass
	H	2483.5 ~ 2483.5+BW	-30.99	-10	Pass
		2483.5+BW ~ 2483.5+2*BW	-31.11	-20	Pass

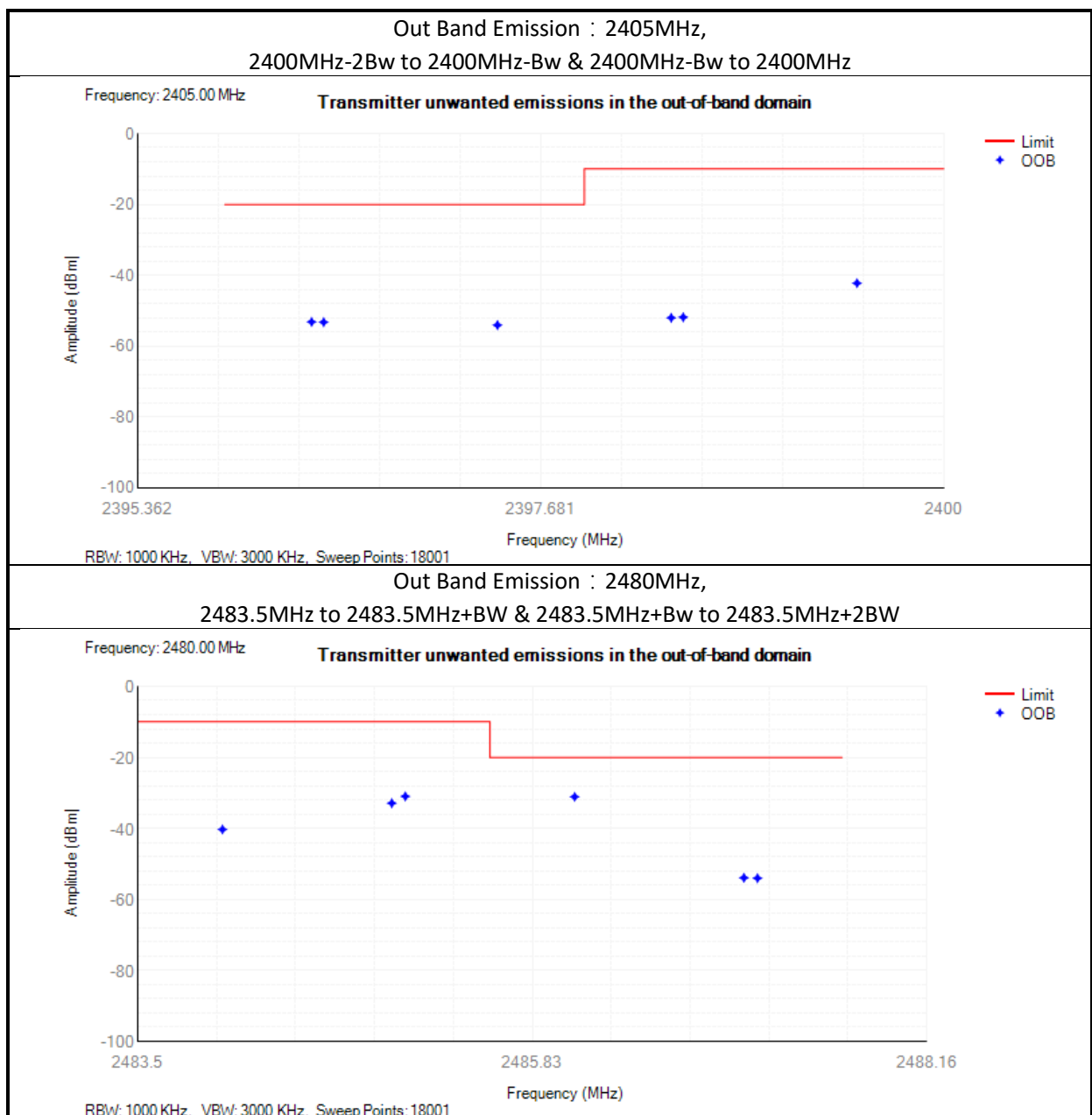



## 9 Transmitter unwanted emissions in the spurious domain

Test result: Pass

### 9.1 Limit

Frequency range	Maximum power, e.r.p. ( $\leq 1$ GHz) e.i.r.p. ( $> 1$ GHz)	Bandwidth
30 MHz to 47 MHz	-36 dBm	100 kHz
47MHz to 74MHz	-54 dBm	100 kHz
74 MHz to 87,5 MHz	-36 dBm	100 kHz
87,5 MHz to 118 MHz	-54 dBm	100 kHz
118 MHz to 174 MHz	-36 dBm	100 kHz
174 MHz to 230 MHz	-54 dBm	100 kHz
230 MHz to 470 MHz	-36 dBm	100 kHz
470 MHz to 694 MHz	-54 dBm	100 kHz
694 MHz to 1 GHz	-36 dBm	100 kHz
1 GHz to 12,75 GHz	-30 dBm	1 MHz

### 9.2 Block Diagram of Test Setup

#### 9.2.1 For conducted method

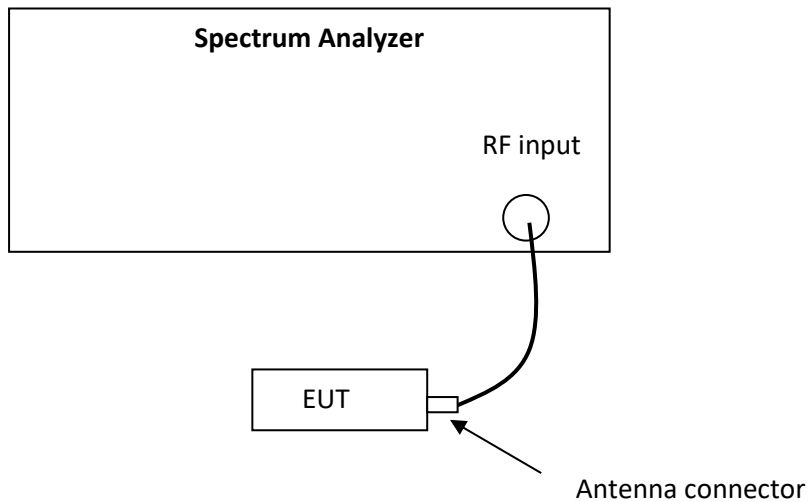

9.2.2 For radiated method

Step one

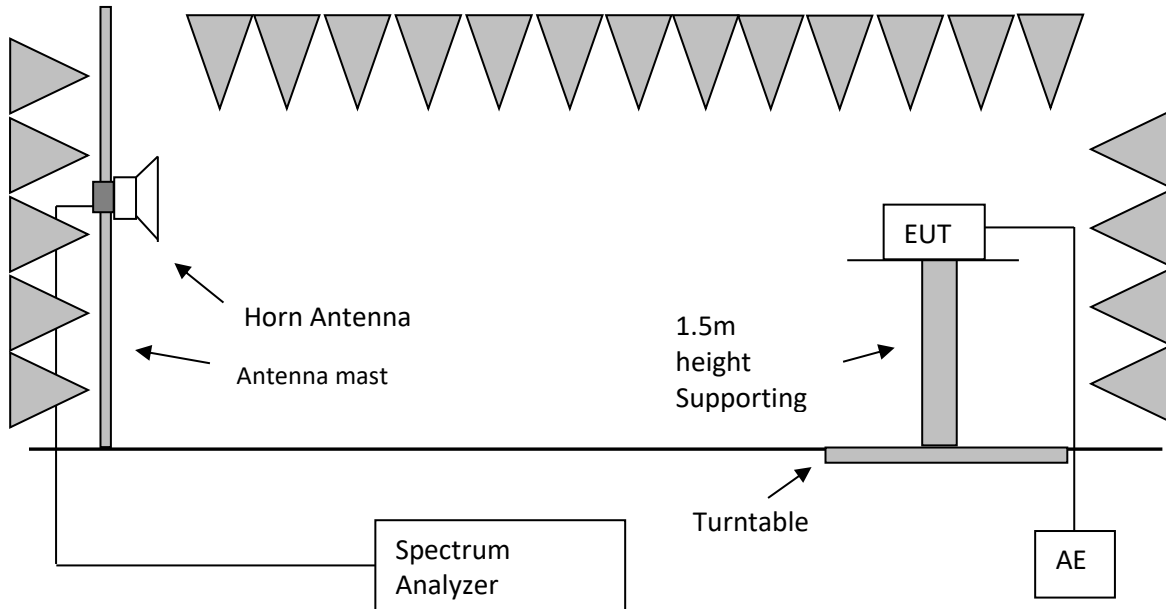

Step two

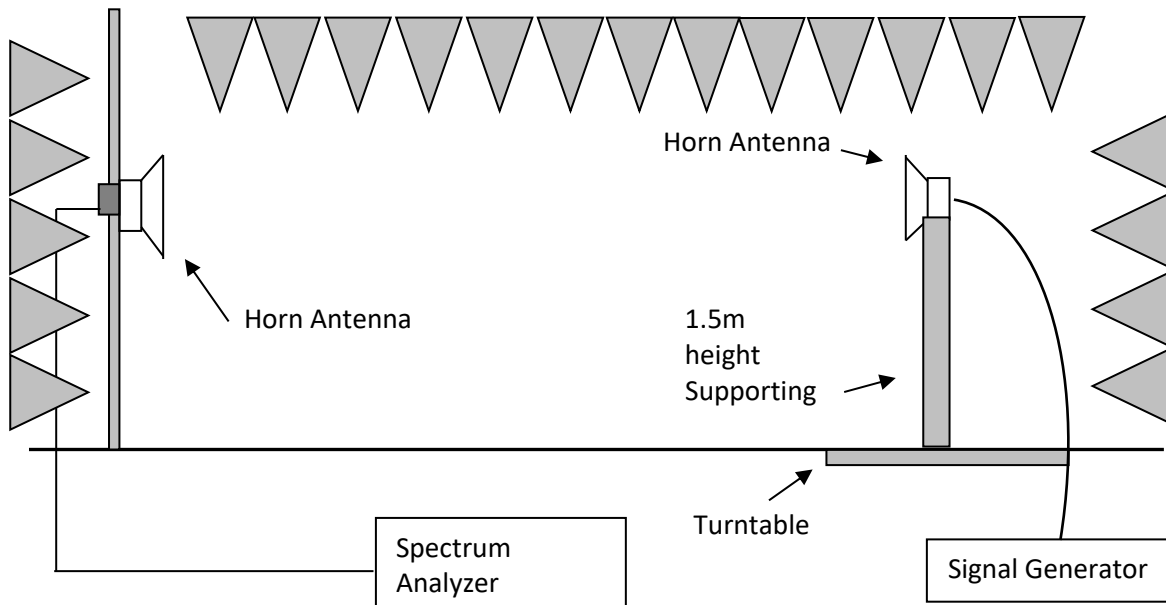

*Note: for frequency lower than the 1GHz, the horn antennas among the two block diagrams above should be replaced with dipole antennas (or other antennas provided they can be referenced to a dipole).*

### 9.3 Test Conditions and Test Method

These measurements shall only be performed at normal test conditions.

For equipment using FHSS modulation, the measurements may be performed when normal hopping is disabled. In this case measurements need to be performed when operating at the lowest and the highest hopping frequency. When this is not possible, the measurement shall be performed during normal operation (hopping).

For equipment using wide band modulations other than FHSS, the measurement shall be performed at the lowest and the highest channel on which the equipment can operate. These operating channels shall be recorded.

The equipment shall be configured to operate under its worst case situation with respect to output power.

If the equipment can operate with different Nominal Channel Bandwidths (e.g. 20 MHz and 40 MHz), then the equipment shall be configured to operate under its worst case situation with respect to spurious emissions.

For conducted method

The EUT was connected to the spectrum analyzer directly. Please refer to EN 300 328 Clause 5.4.9.2.1 for test method.

For radiated method

The measurement was applied in a semi-anechoic chamber. Please refer to EN 300 328 Clause 5.4.9.2.2 for test method.

9.4 Test Result

30MHz-1000MHz

Channel	Frequency (MHz)	Measured Level (dBm)	Limit (dBm)	Antenna Polarization	Pass/Fail
L	38.89	-67.93	-36.00	H	Pass
	90.22	-61.30	-54.00	H	Pass
	166.07	-59.26	-36.00	H	Pass
	248.55	-60.48	-36.00	H	Pass
	416.18	-67.65	-36.00	H	Pass
	798.98	-65.75	-36.00	H	Pass
	45.53	-63.70	-36.00	V	Pass
	88.96	-61.30	-54.00	V	Pass
	133.15	-62.19	-36.00	V	Pass
	232.53	-65.57	-36.00	V	Pass
	417.64	-63.45	-36.00	V	Pass
H	665.80	-64.55	-54.00	V	Pass
	38.89	-66.97	-36.00	H	Pass
	90.22	-61.30	-54.00	H	Pass
	133.15	-61.91	-36.00	H	Pass
	166.07	-58.81	-36.00	H	Pass
	232.53	-60.80	-36.00	H	Pass
	497.68	-65.87	-54.00	H	Pass
	39.02	-64.48	-36.00	V	Pass
	96.10	-61.65	-54.00	V	Pass
	166.65	-64.51	-36.00	V	Pass
	232.53	-65.64	-36.00	V	Pass
414.72	-63.90	-36.00	V	Pass	
668.14	-64.04	-54.00	V	Pass	

1000MHz-12750MHz

Channel	Frequency (MHz)	Measured Level (dBm)	Limit (dBm)	Antenna Polarization	Pass/Fail
L	4807.00	-41.05	-30.00	H	Pass
	7215.00	-42.30	-30.00	H	Pass
	9620.00	-39.37	-30.00	H	Pass
	10494.00	-36.92	-30.00	H	Pass
	11904.00	-35.55	-30.00	H	Pass
	12280.00	-35.27	-30.00	H	Pass
	4807.00	-44.23	-30.00	V	Pass
	7215.00	-43.97	-30.00	V	Pass
	9620.00	-38.83	-30.00	V	Pass
	10682.00	-37.09	-30.00	V	Pass
	11504.50	-35.84	-30.00	V	Pass
	12139.00	-35.33	-30.00	V	Pass
H	4948.00	-38.78	-30.00	H	Pass
	7440.00	-41.65	-30.00	H	Pass
	9920.00	-37.46	-30.00	H	Pass
	11316.50	-37.30	-30.00	H	Pass
	11904.00	-35.45	-30.00	H	Pass
	12397.50	-35.23	-30.00	H	Pass
	4948.00	-45.76	-30.00	V	Pass
	7440.00	-42.50	-30.00	V	Pass
	9920.00	-37.44	-30.00	V	Pass
	11058.00	-36.15	-30.00	V	Pass
	11974.50	-35.02	-30.00	V	Pass
	12468.00	-35.53	-30.00	V	Pass

## 10 Adaptivity

Result: NA

### 10.1 Limit

- For non-FHSS equipment using DAA mechanism, please refer to EN 300 328 clause 4.3.2.6.2;
- For Frame Based Equipment, please refer to EN 300 328 clause 4.3.2.6.3.2.2;
- For Load Based Equipment, please refer to EN 300 328 clause 4.3.2.6.3.2.3;
- For Short Control Signaling Transmissions, please refer to EN 300 328 clause 4.3.2.6.4

Unwanted signal parameters			
Equipment Type	Wanted signal mean power from companion device (dBm)	Unwanted signal frequency (MHz)	Unwanted CW signal power (dBm)
DAA	-30 (see note 2)	2395 or 2488,5 (see note 1)	-35 (see note 2)

NOTE 1: The highest frequency shall be used for testing operating channels within the range 2 400 MHz to 2 442 MHz, while the lowest frequency shall be used for testing operating channels within the range 2 442 MHz to 2 483,5 MHz.

NOTE 2: The level specified is the level at the UUT receiver input assuming a 0 dBi antenna assembly gain. In case of conducted measurements, this level has to be corrected for the (in-band) antenna assembly gain (G). In case of radiated measurements, this level is equivalent to a power flux density in front of the UUT antenna.

Unwanted signal parameters			
Equipment Type	Wanted signal mean power from companion device	Unwanted signal frequency (MHz)	Unwanted CW signal power (dBm)
LBT	sufficient to maintain the link (see note 2)	2395 or 2488,5 (see note 1)	-35 (see note 3)

NOTE 1: The highest frequency shall be used for testing operating channels within the range 2 400 MHz to 2 442 MHz, while the lowest frequency shall be used for testing operating channels within the range 2 442 MHz to 2 483,5 MHz.

NOTE 2: A typical conducted value which can be used in most cases is -50 dBm/MHz.

NOTE 3: The level specified is the level at the UUT receiver input assuming a 0 dBi antenna assembly gain. In case of conducted measurements, this level has to be corrected for the (in-band) antenna assembly gain (G). In case of radiated measurements, this level is equivalent to a power flux density in front of the UUT antenna.

**10.2 Block Diagram of Test Setup**

10.2.1 For conducted method

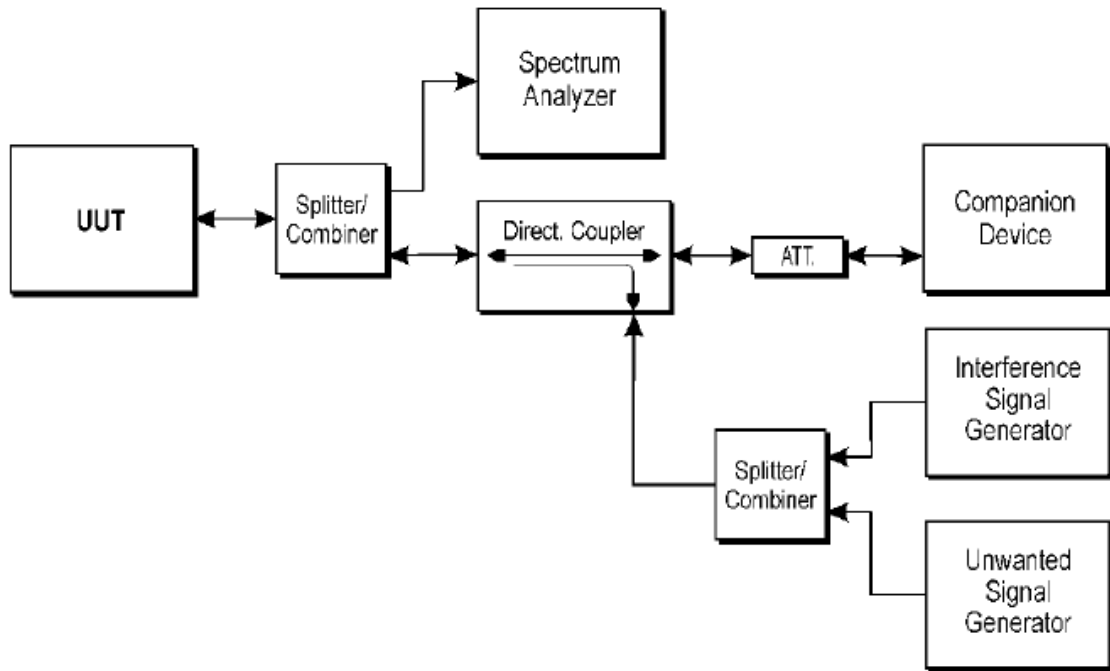

10.2.2 For radiated method

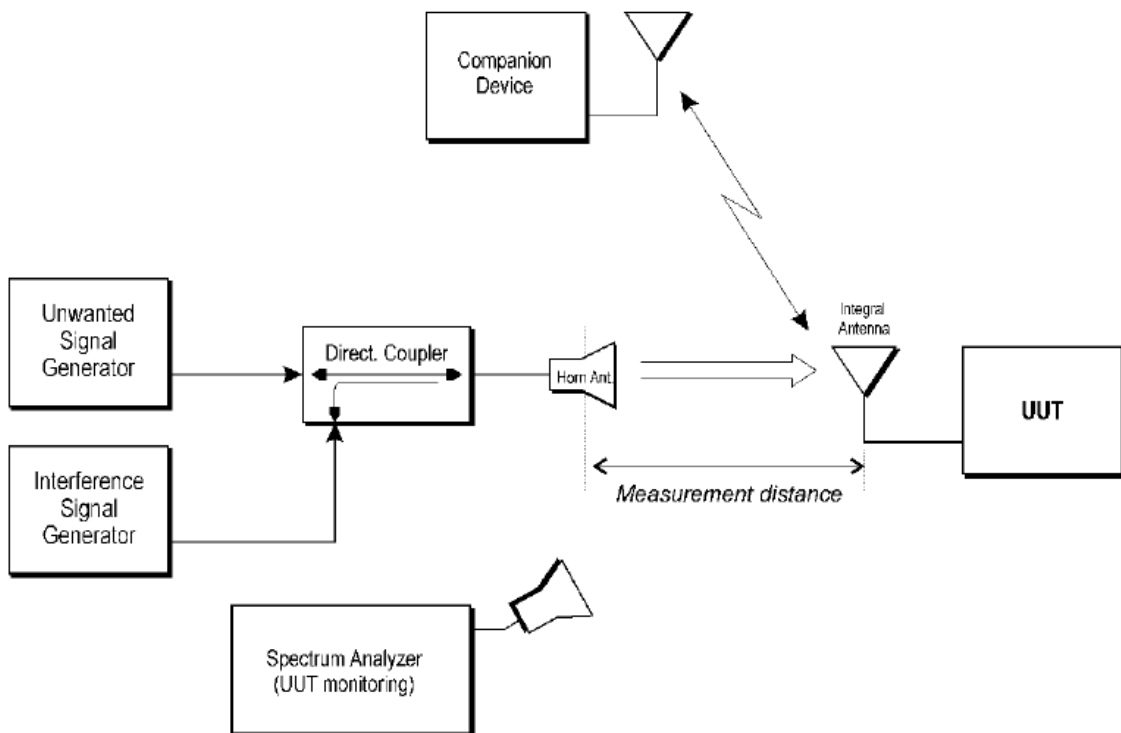

### 10.3 Test Conditions and Test Method

These measurements shall only be performed at normal test conditions.

When supported by the operating frequency range of the equipment, this test shall be performed on two operating (hopping) frequencies randomly selected from the operating frequencies used by the equipment. The first (lower) frequency shall be randomly selected within the range 2 400 MHz to 2 442 MHz while the second (higher) frequency shall be randomly selected within the range 2 442 MHz to 2 483,5 MHz. The equipment shall be in a normal operating (hopping) mode.

For equipment which can operate in an adaptive and a non-adaptive mode, it shall be verified that prior to the test, the equipment is operating in the adaptive mode.

The equipment shall be configured in a mode that results in the longest Channel Occupancy Time.

For conducted method

The EUT was connected to the spectrum analyzer directly. Please refer to EN 300 328 Clause 5.4.6.2.1 for test method.

For radiated method

The measurement was applied in a semi-anechoic chamber. Please refer to EN 300 328 Clause 5.4.6.2.2 for test method.

### 10.4 Test Result

None



## 11 Receiver Blocking

Result: Pass

### 11.1 Limit

Receiver Category 1 Equipment			
Wanted signal mean power from companion device (dBm) (see notes 1 and 4)	Blocking Signal Frequency (MHz)	Blocking Signal Power (dBm) (See note 4)	Type of blocking signal
(-133 dBm + 10 × log <sub>10</sub> (OCBW)) or -68 dBm whichever is less (see note 2)	2 380	-34	CW
	2 504		
(-139 dBm + 10 × log <sub>10</sub> (OCBW)) or -74 dBm whichever is less (see note 3)	2 300		
	2 330		
	2 360		
	2 524		
	2 674		

NOTE 1: OCBW is in Hz.

NOTE 2: In case of radiated measurements using a companion device and the level of the wanted signal from the companion device cannot be determined, a relative test may be performed using a wanted signal up to P<sub>min</sub> + 26 dB where P<sub>min</sub> is the minimum level of wanted signal required to meet the minimum performance criteria as defined in clause 4.3.1.12.3 in the absence of any blocking signal.

NOTE 3: In case of radiated measurements using a companion device and the level of the wanted signal from the companion device cannot be determined, a relative test may be performed using a wanted signal up to P<sub>min</sub> + 20 dB where P<sub>min</sub> is the minimum level of wanted signal required to meet the minimum performance criteria as defined in clause 4.3.1.12.3 in the absence of any blocking signal.

NOTE 4: The level specified is the level at the UUT receiver input assuming a 0 dBi antenna assembly gain. In case of conducted measurements, this level has to be corrected for the (in-band) antenna assembly gain (G). In case of radiated measurements, this level is equivalent to a power flux density (PFD) in front of the UUT antenna with the UUT being configured/positioned as recorded in clause 5.4.3.2.2.

Receiver Category 2 Equipment			
Wanted signal mean power from companion device (dBm) (see notes 1 and 3)	Blocking Signal Frequency (MHz)	Blocking Signal Power (dBm) (See note 3)	Type of blocking signal
(-139 dBm + 10 × log <sub>10</sub> (OCBW) + 10 dB) or (-74 dBm + 10 dB) whichever is less (see note 2)	2 380	-34	CW
	2 504		
	2 300		
	2 584		
<p>NOTE 1: OCBW is in Hz.</p> <p>NOTE 2: In case of radiated measurements using a companion device and the level of the wanted signal from the companion device cannot be determined, a relative test may be performed using a wanted signal up to P<sub>min</sub> + 26 dB where P<sub>min</sub> is the minimum level of wanted signal required to meet the minimum performance criteria as defined in clause 4.3.1.12.3 in the absence of any blocking signal.</p> <p>NOTE 3: The level specified is the level at the UUT receiver input assuming a 0 dBi antenna assembly gain. In case of conducted measurements, this level has to be corrected for the (in-band) antenna assembly gain (G). In case of radiated measurements, this level is equivalent to a power flux density (PFD) in front of the UUT antenna with the UUT being configured/positioned as recorded in clause 5.4.3.2.2.</p>			

Receiver Category 3 Equipment			
Wanted signal mean power from companion device (dBm) (see notes 1 and 3)	Blocking Signal Frequency (MHz)	Blocking Signal Power (dBm) (See note 3)	Type of blocking signal
(-139 dBm + 10 × log <sub>10</sub> (OCBW) + 20 dB) or (-74 dBm + 20 dB) whichever is less (see note 2)	2 380	-34	CW
	2 504		
	2 300		
	2 584		
<p>NOTE 1: OCBW is in Hz.</p> <p>NOTE 2: In case of radiated measurements using a companion device and the level of the wanted signal from the companion device cannot be determined, a relative test may be performed using a wanted signal up to P<sub>min</sub> + 30 dB where P<sub>min</sub> is the minimum level of wanted signal required to meet the minimum performance criteria as defined in clause 4.3.1.12.3 in the absence of any blocking signal.</p> <p>NOTE 3: The level specified is the level at the UUT receiver input assuming a 0 dBi antenna assembly gain. In case of conducted measurements, this level has to be corrected for the (in-band) antenna assembly gain (G). In case of radiated measurements, this level is equivalent to a power flux density (PFD) in front of the UUT antenna with the UUT being configured/positioned as recorded in clause 5.4.3.2.2.</p>			

**11.2 Block Diagram of Test Setup**

11.2.1 For conducted method

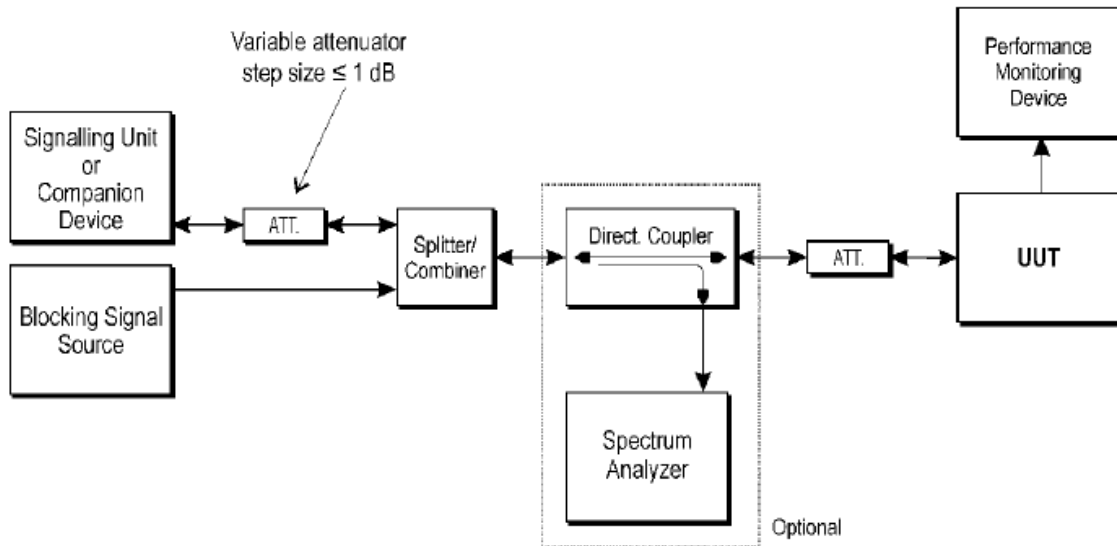

11.2.2 For radiated method

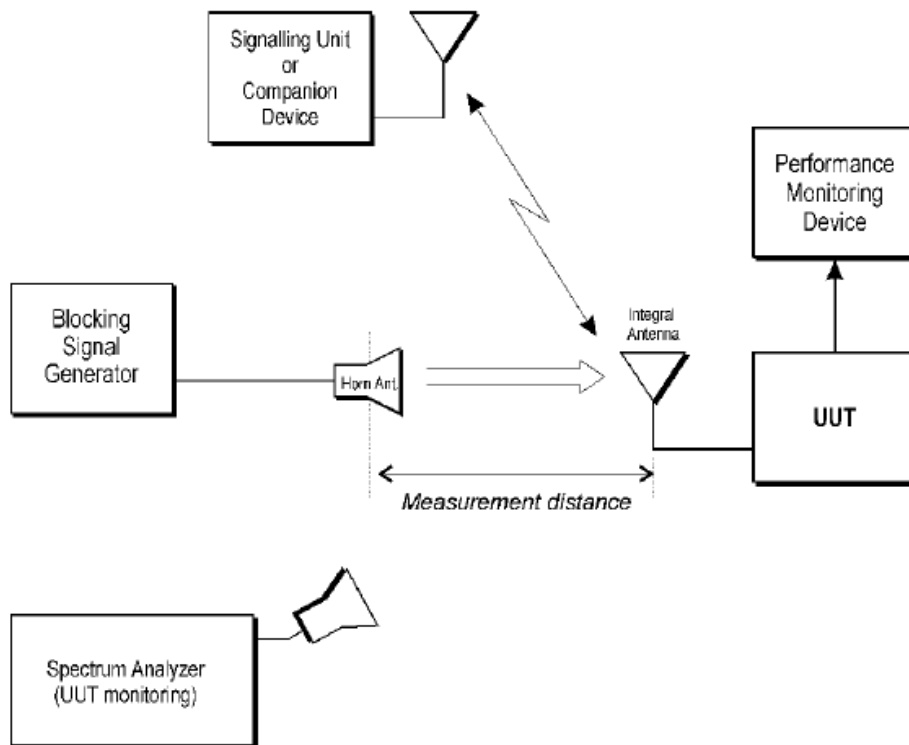

### 11.3 Test Conditions and Test Method

These measurements shall only be performed at normal test conditions.

For non-FHSS equipment, having more than one operating channel, the operating channels on which the testing has to be performed shall be selected as follows:

- For testing blocking frequencies less than 2 400 MHz, the equipment shall operate on the lowest operating channel.
- For testing blocking frequencies greater than 2 500 MHz, the equipment shall operate on the highest operating channel.

Equipment which can change their operating channel automatically (adaptive channel allocation), and where this function cannot be disabled, shall be tested as a FHSS equipment.

If the equipment can be configured to operate with different Nominal Channel Bandwidths (e.g. 20 MHz and 40 MHz) and different data rates, then the combination of the smallest channel bandwidth and the lowest data rate for this channel bandwidth which still allows the equipment to operate as intended shall be used. This mode of operation shall be aligned with the performance criteria defined in clause 4.3.1.12.3 or clause 4.3.2.11.3 and shall be described in the test report.

For conducted method

The EUT was connected to the spectrum analyzer directly. Please refer to EN 300 328 Clause 5.4.11.2.1 for test method.

For radiated method

The measurement was applied in a semi-anechoic chamber. Please refer to EN 300 328 Clause 5.4.11.2.2 for test method.

11.4 Test Result

Mode	Channel	Wanted Signal mean power from companion device (dBm)	Blocking signal (MHz)	Blocking signal power (dBm)	FER (%)	Pass/Fail
Zigbee	L	-65.84	2 380	-32	0	Pass
		-65.82	2 300		0	Pass
	H	-65.84	2 504	-32	1	Pass
		-65.82	2 584		0	Pass

Note 1: OCBW is in Hz.

Note 2: The Performance Criteria is based on the PER less than or equal to 10 %.

Note 3: For the conducted measurements, the actual blocking signal power = blocking signal power + Antenna Gain

## 12 Receiver spurious emission

Test result: Pass

### 12.1 Limit

Frequency range	Maximum power, e.r.p. ( $\leq 1$ GHz) e.i.r.p. ( $> 1$ GHz)	Bandwidth
30 MHz to 1 GHz	-57 dBm	100 kHz
1 GHz to 12,75 GHz	-47 dBm	1 MHz

### 12.2 Block Diagram of Test Setup

#### 12.2.1 For conducted method

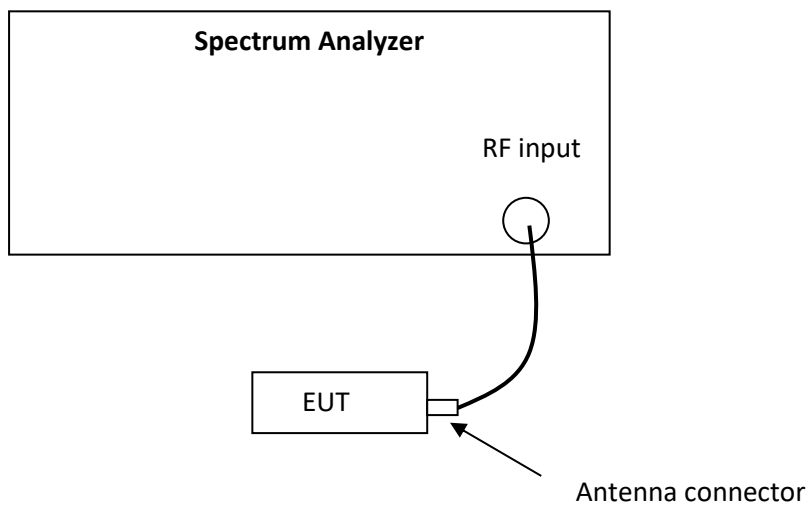

12.2.2 For radiated method

Step one

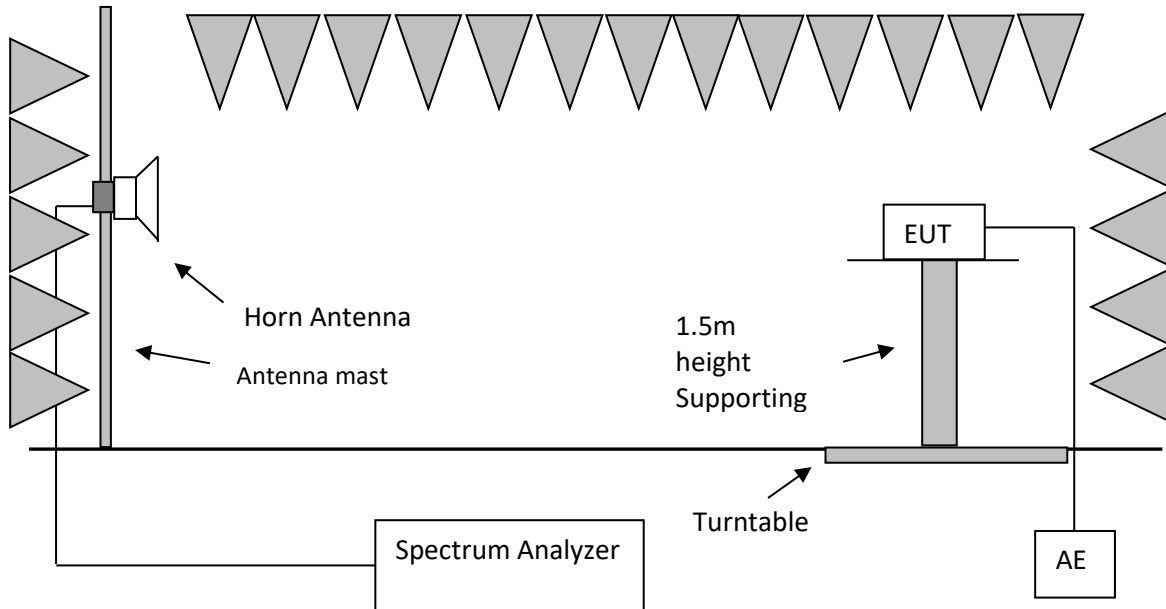

Step two

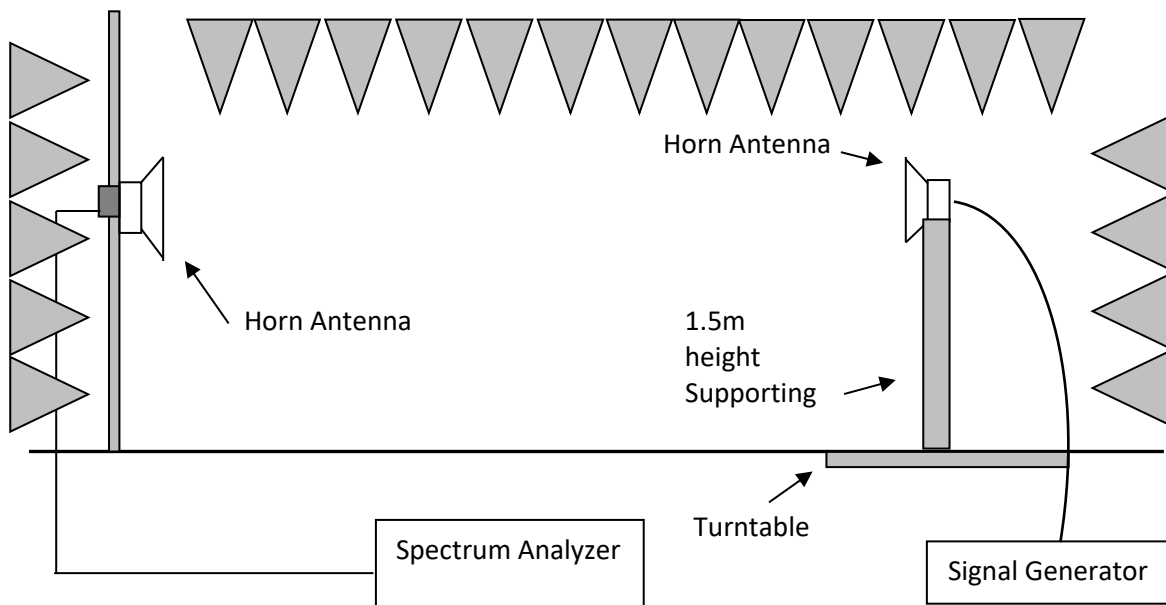

*Note: for frequency lower than the 1GHz, the horn antennas among the two block diagrams above should be replaced with dipole antennas (or other antennas provided they can be referenced to a dipole).*

### 12.3 Test Conditions and Test Method

These measurements shall only be performed at normal test conditions.

Testing shall be performed when the equipment is in a receive-only mode.

For equipment using wide band modulations other than FHSS, the measurement shall be performed at the lowest and the highest channel on which the equipment can operate. These frequencies shall be recorded.

For equipment using FHSS modulation, the measurements may be performed when normal hopping is disabled. In this case measurements need to be performed when operating at the lowest and the highest hopping frequency. These frequencies shall be recorded. When disabling the normal hopping is not possible, the measurement shall be performed during normal operation (hopping).

For conducted method

The EUT was connected to the spectrum analyzer directly. Please refer to EN300 328 Clause 5.4.10.2.1 for test procedure.

For radiated method

The measurement was applied in a semi-anechoic chamber. Please refer to EN300 328 Clause 5.4.10.2.2 for test procedure.



**12.4 Test protocol**

Channel	Frequency (MHz)	Measured Level (dBm)	Limit (dBm)	Antenna Polarization	Pass/Fail
L	≤ 1GHz	< -67.00	-57.00	H	Pass
	≤ 1GHz	< -67.00	-57.00	V	Pass
	> 1GHz	< -57.00	-47.00	H	Pass
	> 1GHz	< -57.00	-47.00	V	Pass
H	≤ 1GHz	< -67.00	-57.00	H	Pass
	≤ 1GHz	< -67.00	-57.00	V	Pass
	> 1GHz	< -57.00	-47.00	H	Pass
	> 1GHz	< -57.00	-47.00	V	Pass

## 13 Geo-location capability

Test result: NA

### 13.1 Applicability

This requirement only applies to equipment with geo-location capability.

### 13.2 Requirements

The geographical location determined by the equipment as defined in clause shall not be accessible to the user.

### 13.3 Description

This device doesn't support this capability declared by the manufacturer.

Appendix I: Photograph of equipment under test

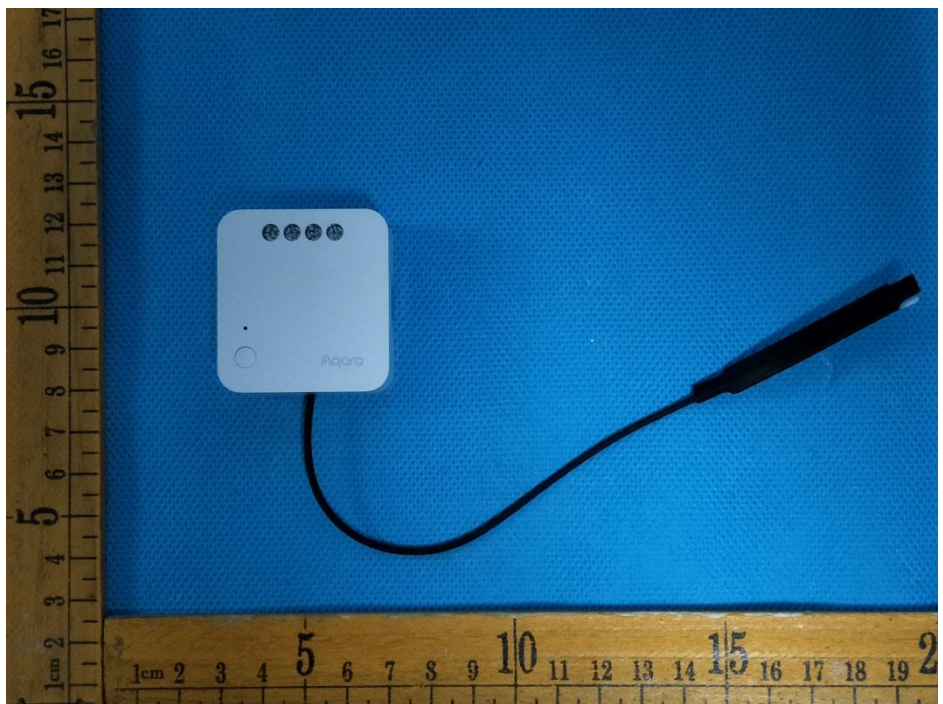







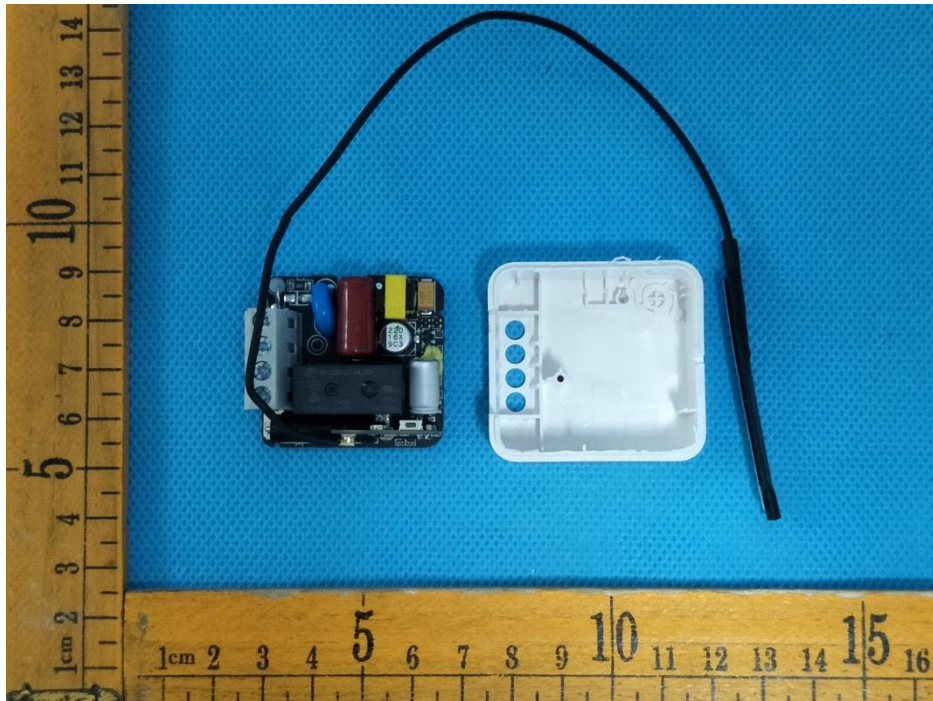
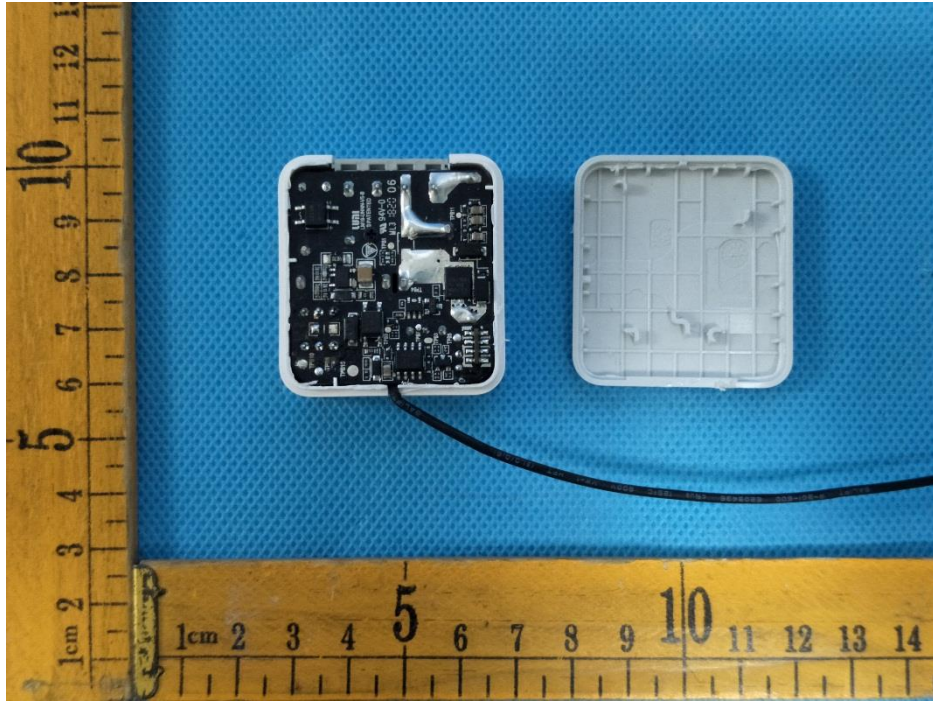

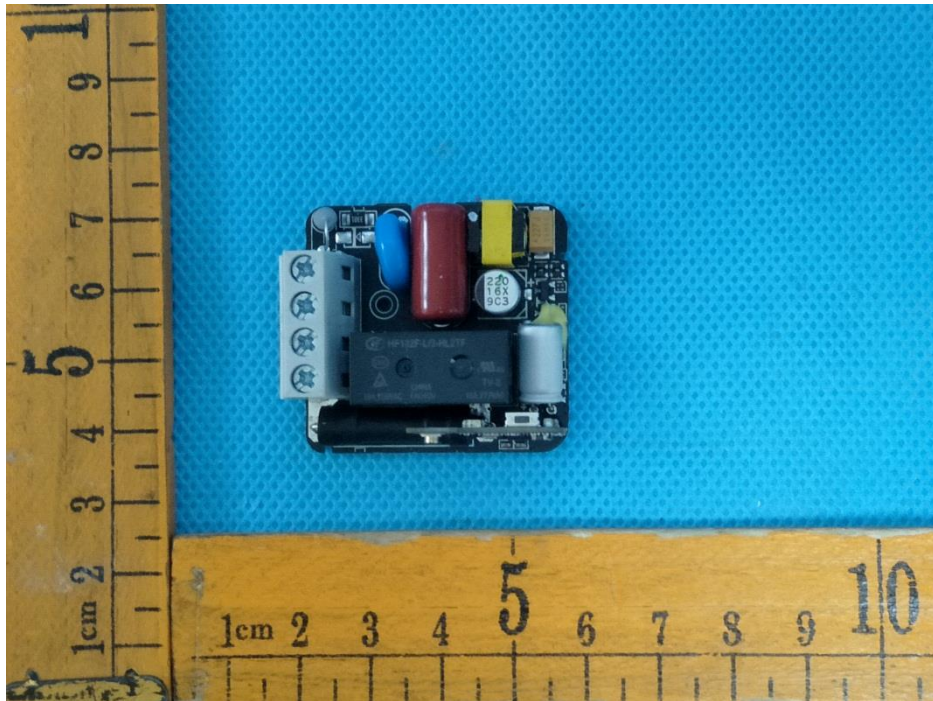
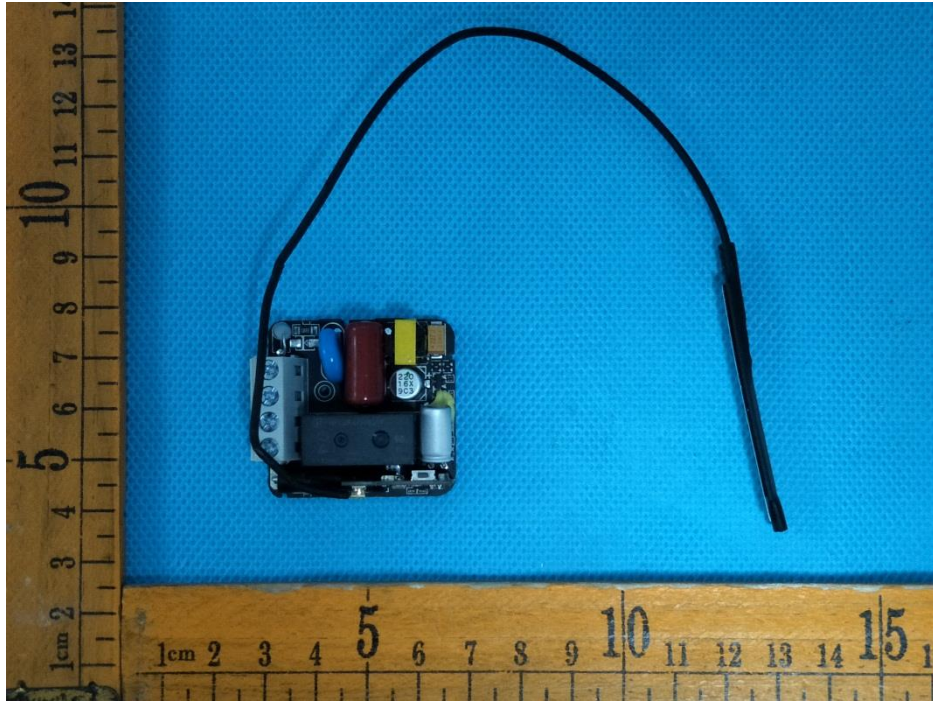



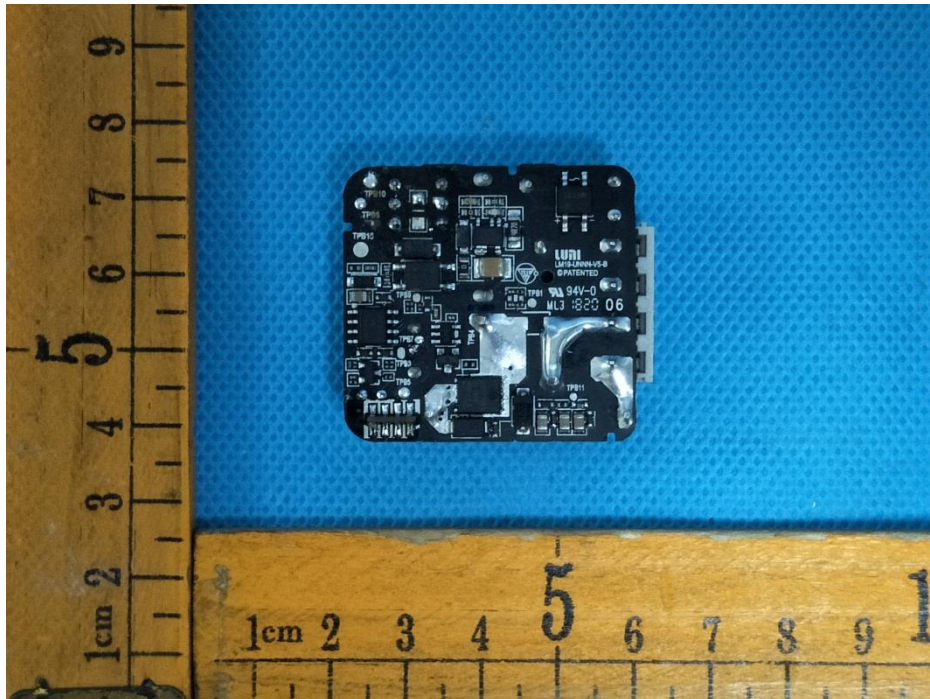
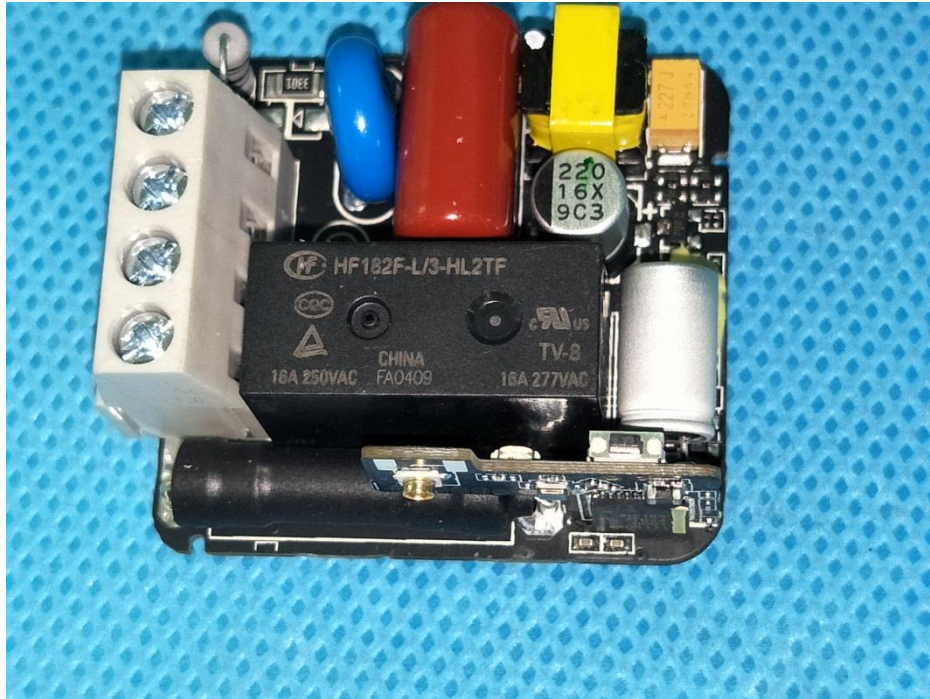

\*\*\*\*\* END \*\*\*\*\*