



中国认可
国际互认
检测
TESTING
CNAS L0446



Page 1 of 99

Test Report

Verified code: 554392

Report No.: E20220818423001-1

Customer: Lumi United Technology Co., Ltd

Address: Room 801-804, Building 1, Chongwen Park, Nanshan iPark, No.3370, Liuxian Avenue, Fuguang Community, Taoyuan Residential District, Nanshan District, Shenzhen, China

Sample Name: Smart Video Doorbell G4

Sample Model: SVD-C01

Receive Sample Date: Aug.19,2022

Test Date: Aug.19,2022 ~ Oct.14,2022

Reference Document: ETSI EN 300 328 V2.2.2 (2019-07)

Test Result: Pass

Prepared by: *Huang Lifang*

Reviewed by: *Wu Haoting*

Approved by: *Xiao Liang*

GUANGZHOU GRG METROLOGY & TEST CO., LTD

Issued Date: 2022-11-29

GUANGZHOU GRG METROLOGY & TEST CO., LTD.

Address: No.163, Pingyun Road, West of Huangpu Avenue, Guangzhou, Guangdong, China
Tel: (+86) 400-602-0999 FAX: (+86) 020-38698685 Web: <http://www.grgtest.com>



Statement

1. The report is invalid without "special seal for inspection and testing"; some copies are invalid; The report is invalid if it is altered or missing; The report is invalid without the signature of the person who prepared, reviewed and approved it.
2. The sample information is provided by the client and responsible for its authenticity; The content of the report is only valid for the samples sent this time.
3. When there are reports in both Chinese and English, the Chinese version will prevail when the language problems are inconsistent.
4. If there is any objection concerning the report, please inform us within 15 days from the date of receiving the report.
5. Without the agreement of the laboratory, the client is not authorized to use the test results for unapproved propaganda.

----- The following blanks -----

TABLE OF CONTENTS

1.	TEST RESULT SUMMARY	6
2.	GENERAL DESCRIPTION OF EUT	7
2.1	APPLICANT INFORMATION.....	7
2.2	MANUFACTURER	7
2.3	BASIC DESCRIPTION OF EUT	7
2.4	TEST MODE	8
2.5	FREQUENCY BAND AND THE TEST FREQUENCY.....	8
2.6	DESCRIPTION OF ADAPTIVE EQUIPMENT.....	8
3.	LABORATORY AND ACCREDITATIONS	9
3.1	LABORATORY	9
3.2	ACCREDITATIONS.....	9
3.3	MEASUREMENTS UNCERTAINTY.....	10
4.	EQUIPMENT AND TOOLS USED DURING TEST.....	11
4.1	TEST EQUIPMENT AND TOOLS	11
4.2	LOCAL SUPPORTIVE INSTRUMENTS	12
4.3	CONFIGURATION OF SYSTEM UNDER TEST.....	12
4.4	TEST SOFTWARE	12
5.	RADIO TECHNICAL REQUIREMENT SPECIFICATION	13
5.1	RF OUTPUT POWER.....	13
5.1.1	LIMIT	13
5.1.2	TEST CONFIGURATION	13
5.1.3	TEST PROCEDURES	13
5.1.4	TEST RESULTS.....	14
5.2	POWER SPECTRAL DENSITY.....	15
5.2.1	LIMIT	15
5.2.2	TEST CONFIGURATION	15
5.2.3	TEST PROCEDURES	15
5.2.4	TEST RESULTS.....	16
5.3	ADAPTIVITY	21
5.3.1	LIMIT	21
5.3.2	TEST CONFIGURATION	21
5.3.3	TEST PROCEDURES	21
5.3.4	TEST RESULTS.....	22
5.4	OCCUPIED CHANNEL BANDWIDTH.....	29
5.4.1	LIMIT	29
5.4.2	TEST CONFIGURATION	29
5.4.3	TEST PROCEDURES	29
5.4.4	TEST RESULTS.....	30
5.5	TRANSMITTER UNWANTED EMISSIONS IN THE OUT-OF-BAND DOMAIN	35

5.5.1	LIMIT	35
5.5.2	TEST CONFIGURATION	35
5.5.3	TEST PROCEDURES	35
5.5.4	TEST RESULTS.....	36
5.6	TRANSMITTER UNWANTED EMISSIONS IN THE SPURIOUS DOMAIN	51
5.6.1	LIMIT	51
5.6.2	TEST CONFIGURATION	52
5.6.3	TEST PROCEDURES	53
5.6.4	DATA SAMPLE.....	53
5.6.5	TEST RESULTS.....	54
5.7	RECEIVER SPURIOUS EMISSIONS.....	66
5.7.1	LIMIT	66
5.7.2	TEST PROCEDURES	68
5.7.3	DATA SAMPLE.....	68
5.7.4	TEST RESULTS.....	69
5.8	RECEIVER BLOCKING	81
5.8.1	LIMIT	81
5.8.2	TEST CONFIGURATION	82
5.8.3	TEST PROCEDURES	83
5.8.4	TEST RESULTS.....	85
	APPENDIX A. PHOTOGRAPH OF THE TEST CONNECTION DIAGRAM.....	87
	APPENDIX B. PHOTOGRAPH OF THE EUT.....	88

----- The following blanks -----

REPORT ISSUED HISTORY

Report Version	Report No.	Description	Compile Date
1.0	E20220818423001-1	Original Issue	2022-10-14

----- The following blanks -----

1. TEST RESULT SUMMARY

Test Item	Test mode	Test Requirement	Test Method	Class / Severity	Test Result
1. Transmitter Part					
RF Output Power	Mode 1	EN300 328 V2.2.2/4.3.2.2	EN300 328 V2.2.2/5.4.2.2.1	Meet requirements: EN300 328 V2.2.2/4.3.2.2	PASS
Power Spectral Density	Mode 1	EN300 328 V2.2.2/4.3.2.3	EN300 328 V2.2.2/5.4.3.2.1	Meet requirements: EN300 328 V2.2.2/4.3.2.3	PASS
Duty Cycle, Tx-sequence, Tx-gap	Mode 1	EN300 328 V2.2.2/4.3.2.4	EN300 328 V2.2.2/5.4.2.2.1	Meet requirements: EN300 328 V2.2.2/4.3.2.4	N/A
Medium Utilisation (MU) factor	Mode 1	EN300 328 V2.2.2/4.3.2.5	EN300 328 V2.2.2/5.4.2.2	Meet requirements: EN300 328 V2.2.2/4.3.2.5	N/A
Adaptivity	Mode 3	EN300 328 V2.2.2/4.3.2.6	EN300 328 V2.2.2/5.4.6.2.1	Meet requirements: EN300 328 V2.2.2/4.3.2.6	PASS
Occupied Channel Bandwidth	Mode 1	EN300 328 V2.2.2/4.3.2.7	EN300 328 V2.2.2/5.4.7.2.1	Meet requirements: EN300 328 V2.2.2/4.3.2.7	PASS
Transmitter unwanted emissions in the out-of-band domain	Mode 1	EN300 328 V2.2.2/4.3.2.8	EN300 328 V2.2.2/5.4.8.2.1	Meet requirements: EN300 328 V2.2.2/4.3.2.8	PASS
Transmitter unwanted emissions in the spurious domain	Mode 1	EN300 328 V2.2.2/4.3.2.9	EN300 328 V2.2.2/5.4.9.2.2	Meet requirements: EN300 328 V2.2.2/4.3.2.9	PASS
2. Receiver Part					
Receiver spurious emissions	Mode 2	EN300 328 V2.2.2/4.3.2.10	EN300 328 V2.2.2/5.4.10.2.2	Meet requirements: EN300 328 V2.2.2/4.3.2.10	PASS
Receiver Blocking	Mode 2	EN300 328 V2.2.2/4.3.2.11	EN300 328 V2.2.2/5.4.11.2.1	Meet requirements: EN300 328 V2.2.2/4.3.2.11	PASS

Note:

1. N/A = Not Applicable. These requirements apply to non-adaptive equipment or to adaptive equipment when operating in a non-adaptive mode. This item does not apply for equipment with a declared RF Output power level of less than 10 dBm e.i.r.p. or for equipment when operating in a mode where the RF Output power is less than 10 dBm e.i.r.p, the EUT is a adaptive equipment without the possibility to switch to a non-adaptive mode, so it is not applicable.

2. GENERAL DESCRIPTION OF EUT

2.1 APPLICANT INFORMATION

Name: Lumi United Technology Co., Ltd
Address: Room 801-804, Building 1, Chongwen Park, Nanshan iPark, No.3370, Liuxian Avenue, Fuguang Community, Taoyuan Residential District, Nanshan District, Shenzhen, China

2.2 MANUFACTURER

Name: Lumi United Technology Co., Ltd
Address: Room 801-804, Building 1, Chongwen Park, Nanshan iPark, No.3370, Liuxian Avenue, Fuguang Community, Taoyuan Residential District, Nanshan District, Shenzhen, China

2.3 BASIC DESCRIPTION OF EUT

Product Name: Smart Video Doorbell G4
Product Model: SVD-C01
Adding Model: SVD-C03
Models Difference: that EUT (Smart Video Doorbell G4) Model Numbers SVD-C01 and SVD-C03 have the same technical construction including circuit diagram,PCB LAYOUT,hardware version and software version identical,except color of enclosures and sales method are different.
Trade Name: Aqara
Power Supply: AC 12-24V power supplied by AC power convert
DC 8-24V power supplied by DC adapter
DC 4.5V power supplied by battery
Frequency Band: 2412MHz-2472MHz for 802.11b/g/n HT20
Modulation Type: DSSS for 802.11b mode;
OFDM for 802.11g mode;
OFDM for 802.11n mode.
Antenna Specification: FPC antenna with 0.5dBi gain (Max)
Hardware Version: T0
Software Version: 1.0.4_0010
Sample submitting way: Provided by customer Sampling
Sample No: E20220818423001-0001, E20220818423001-0003
Note: /

2.4 TEST MODE

Mode No.	Description of the modes
1	2.4G Wi-Fi TX mode
2	2.4G Wi-Fi RX mode
3	Work Normal 2.4G Wi-Fi mode

2.5 FREQUENCY BAND AND THE TEST FREQUENCY

Channel	Frequency (MHz)	Channel	Frequency (MHz)	Channel	Frequency (MHz)	Channel	Frequency (MHz)
*1	2412	5	2432	9	2452	*13	2472
2	2417	6	2437	10	2457	---	---
3	2422	*7	2442	11	2462	---	---
4	2427	8	2447	12	2467	---	---

* is the test frequency

2.6 DESCRIPTION OF ADAPTIVE EQUIPMENT

The type of the equipment	<input type="checkbox"/> FHSS	<input checked="" type="checkbox"/> Non-FHSS		
Adaptive / non-adaptive equipment	<input type="checkbox"/> Non-adaptive Equipment	<input checked="" type="checkbox"/> adaptive Equipment without the possibility to switch to a non-adaptive mode	<input type="checkbox"/> adaptive Equipment which can also operate in a non-adaptive mode	
The equipment has an implemented	<input type="checkbox"/> Frame Based equipment	<input checked="" type="checkbox"/> Load Based equipment	<input type="checkbox"/> non-LBT based DAA mechanism	<input type="checkbox"/> other
Device Class	<input checked="" type="checkbox"/> WIFI	<input type="checkbox"/> Bluetooth Low Energy (5.0)	<input type="checkbox"/> Bluetooth EDR/BR (5.0)	
Wi-Fi Channel Bandwidth	<input checked="" type="checkbox"/> 20MHz	<input type="checkbox"/> 40MHz	<input type="checkbox"/> 80MHz	<input type="checkbox"/> 160MHz
Antenna Gain	<input checked="" type="checkbox"/> Antenna1 0.5dBi	<input type="checkbox"/> Antenna 2 dBi	<input type="checkbox"/> Antenna 3 dBi	<input type="checkbox"/> Antenna 4 dBi
Beamforming Gain	<input type="checkbox"/> Yes, dBi	<input checked="" type="checkbox"/> No		
Extreme operating conditions	<input checked="" type="checkbox"/> Operating temperature range:	<input checked="" type="checkbox"/> Min -10°C	<input checked="" type="checkbox"/> Max +55 °C	
Blocking	<input checked="" type="checkbox"/> PER	<input type="checkbox"/> The manufacturer may declare alternative performance criteria		
Geo-location capability supported by the equipment	<input type="checkbox"/> Yes	<input checked="" type="checkbox"/> No		

The EUT is Receiver Category 1 equipment.

3. LABORATORY AND ACCREDITATIONS

3.1 LABORATORY

The tests & measurements refer to this report were performed by Shenzhen EMC Laboratory of Guangzhou GRG Metrology & Test Co., Ltd.

Add.: No.1301 Guanguang Road Xinlan Community, Guanlan Street, Longhua District
Shenzhen, 518110, People's Republic of China.

P.C.: 518110

Tel : 0755-61180008

Fax: 0755-61180008

3.2 ACCREDITATIONS

Our laboratories are accredited and approved by the following approval agencies according to GB/T 27025(ISO/IEC 17025:2017)

USA A2LA(Certificate #2861.01)

China CNAS(L0446)

The measuring facility of laboratories has been authorized or registered by the following approval agencies.

Canada ISED (Company Number: 24897, CAB identifier:CN0069)

USA FCC (Registration Number: 759402, Designation Number:CN1198)

Copies of granted accreditation certificates are available for downloading from our web site,
<http://www.grgtest.com>

----- The following blanks -----

3.3 MEASUREMENTS UNCERTAINTY

Where relevant, the following measurement uncertainty levels have been estimated for tests performed on the EUT as specified in ETSI EN TR 100 028-1 (i.15) and ETSI EN 100 028-2 (i 8):

Measurement		Frequency	Uncertainty
Radiated Emission	Horizontal	30MHz~1000MHz	4.3dB
		1GHz~18GHz	5.6dB
	Vertical	30MHz~1000MHz	4.3dB
		1GHz~18GHz	5.6dB

Measurement	Uncertainty
RF frequency	6.0×10^{-6}
RF power conducted	0.78 dB
Occupied channel bandwidth	0.4 dB
Unwanted emission, conducted	0.68 dB
Humidity	6 %
Temperature	2°C

This uncertainty represents an expanded uncertainty factor of $k=2$.

----- The following blanks -----

4. EQUIPMENT AND TOOLS USED DURING TEST

4.1 TEST EQUIPMENT AND TOOLS

Name of Equipment	Manufacturer	Model	Serial Number	Calibration Due
Maximum transmit power & Maximum e.i.r.p. spectral density & occupied channel bandwidth & Transmitter unwanted emissions in the out-of-band domain				
Simultaneous sampling DAQ	TONSCEND	JS0806-2	186060020	2023-07-24
High and low temperature humid heat test chamber	HOSON	HS01060SDF	191008401	2023-08-19
Pulse power sensor	TONSCEND	u2021A	I00641	2023-07-24
Spectrum Analyzer	Agilent	N9020A	MY50510140	2022-11-08
BT/Wi-Fi System	TONSCEND	JS1120-3		
Transmitter unwanted emissions in the spurious domain & Receiver spurious emissions				
Bi-log Antenna	Schwarzbeck	VULB9163	01279	2023-03-15
Horn Antenna	Schwarzbeck	BBHA9120D	02499	2023-09-25
Amplifier	Tonscend	TAP037030	AP20E8060081	2023-05-08
Amplifier	Tonscend	TAP01018048	AP20E8060076	2023-05-05
Amplifier	Tonscend	TAP9E6343	AP20E806065	2023-05-08
Spectrum Analyzer	KEYSIGHT	N9010A	MY55370330	2022-11-08
Spectrum Analyzer	R&S	FSV3044	101184	2023-09-02
Test S/W	TONSCEND	JS36-RSE/2.5.1.5		
Adaptivity				
Spectrum Analyzer	Agilent	N9020A	MY50510140	2022-11-08
Vector Signal Generator	Agilent	N5182A	MY5014870	2023-08-11
Signal Generator	Anritsu	MG3694A	#050125	2023-08-16
BT/Wi-Fi System	TONSCEND	JS1120-3		
Receiver Blocking				
Signal Generator	Anritsu	MG3694A	#050125	2023-08-16
Wideband radio Communication Tester	R&S	CMW500	144611-nC	2023-05-08
BT/Wi-Fi System	TONSCEND	JS1120-3		

Note: The calibration interval of the above test instruments is 12 months.

4.2 LOCAL SUPPORTIVE INSTRUMENTS

Name of Equipment	Manufacturer	Model	Serial Number	Note
Notebook	LENOVO	TianYi 310-14ISK	MP18DLC6	/
Test board	/	/	/	/
Adapter	Jingsai	/	/	/

No.	Cable Type	Qty.	Shielded Type	Ferrite Core(Qty.)	Length
1	USB cable	1	No	0	0.5m
2	DC cable	1	No	0	0.2m
3	RF cable	1	No	0	0.1m
4	AC cable	1	No	0	1.2m

Note: ⁽¹⁾The notebook is just used to produce fixed frequency transmitting.

4.3 CONFIGURATION OF SYSTEM UNDER TEST

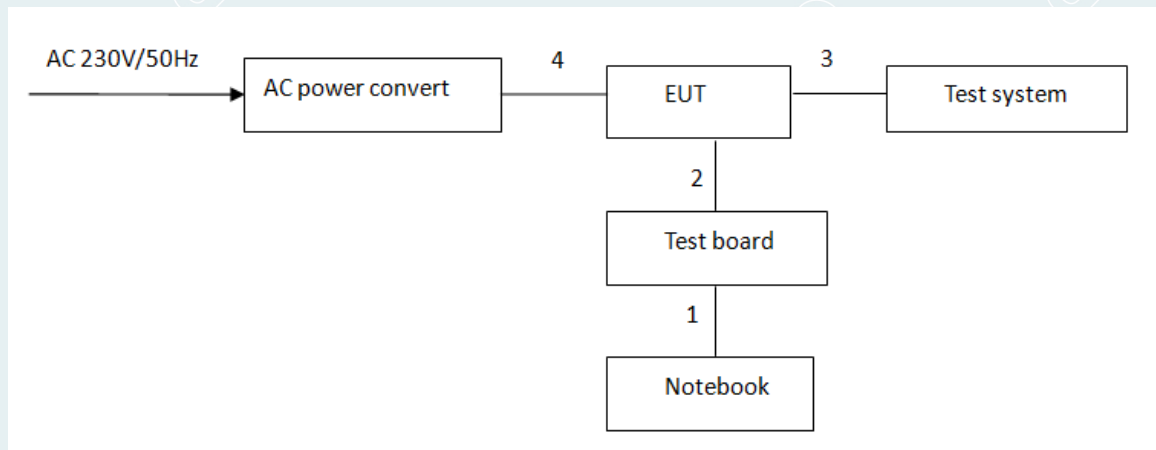

4.4 TEST SOFTWARE

Software version	Test level
QCOM_V1.0	802.11b: -30 802.11g: -30 802.11n HT20: -30

5. RADIO TECHNICAL REQUIREMENT SPECIFICATION

5.1 RF OUTPUT POWER

Test Requirement: EN300 328 V2.2.2/ 4.3.2.2

Test Method: EN300 328 V2.2.2/5.4.2.2.1

5.1.1 LIMIT

The RF output power for non-FHSS equipment shall be equal to or less than 20 dBm.

5.1.2 TEST CONFIGURATION

Conducted measurement:

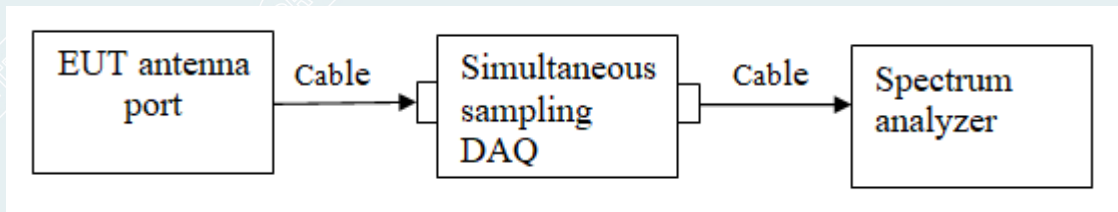

5.1.3 TEST PROCEDURES

Test procedure: Test procedure is according to Clause 5.4.2.2.1 of EN 300 328 V2.2.2

Test channel: 2412MHz, 2442MHz, 2472MHz for 802.11b/g/n HT20

Test condition: Normal and extreme test conditions.

----- The following blanks -----

5.1.4 TEST RESULTS

Test environment: Normal condition: 23.8°C/51%RH/101.0kPa

Extreme test conditions: Minimum Temp: -10°C

Maximum Temp: +55°C

Test Engineer: Qin Tingting

Test Date: 2022-09-26

Test Condition	Test Mode	Antenna	Frequency [MHz]	EIRP[dBm]	Limit[dBm]	Verdict
NTNV	802.11b	Ant1	2412	14.48	20	PASS
			2442	14.87	20	PASS
			2472	15.55	20	PASS
	802.11g	Ant1	2412	12.84	20	PASS
			2442	11.79	20	PASS
			2472	13.05	20	PASS
	802.11n HT20	Ant1	2412	13.00	20	PASS
			2442	12.67	20	PASS
			2472	12.93	20	PASS
LTNV	802.11b	Ant1	2412	14.33	20	PASS
			2442	14.88	20	PASS
			2472	15.53	20	PASS
	802.11g	Ant1	2412	12.79	20	PASS
			2442	11.91	20	PASS
			2472	12.89	20	PASS
	802.11n HT20	Ant1	2412	12.87	20	PASS
			2442	12.69	20	PASS
			2472	12.92	20	PASS
HTNV	802.11b	Ant1	2412	14.40	20	PASS
			2442	14.72	20	PASS
			2472	15.43	20	PASS
	802.11g	Ant1	2412	12.95	20	PASS
			2442	11.86	20	PASS
			2472	13.09	20	PASS
	802.11n HT20	Ant1	2412	12.96	20	PASS
			2442	12.75	20	PASS
			2472	12.76	20	PASS

5.2 POWER SPECTRAL DENSITY

Test Requirement: EN300 328 V2.2.2/4.3.2.3

Test Method: EN300 328 V2.2.2/5.4.3.2.1

5.2.1 LIMIT

This requirement applies to all types of equipment using wide band modulations other than FHSS.

For equipment using wide band modulations other than FHSS, the maximum Power Spectral Density is limited to 10 dBm per MHz.

5.2.2 TEST CONFIGURATION

Conducted measurement:

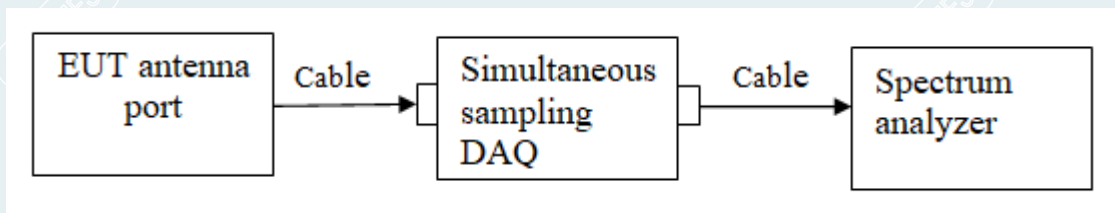

5.2.3 TEST PROCEDURES

Test condition: Normal test conditions

Test channel: 2412MHz, 2442MHz, 2472MHz for 802.11b/g/n HT20

Test procedure: Test procedure is according to Clause 5.4.3.2.1 of EN 300 328 V2.2.2

Remark: /

----- The following blanks -----

5.2.4 TEST RESULTS

Test environment: Normal condition:
23.8°C/51%RH/101.0kPa

Test Engineer: Qin Tingting

Test Date: 2022-09-26

Test Mode	Antenna	Frequency [MHz]	PSD[dBm/MHz]	Limit[dBm/MHz]	Verdict
802.11b	Ant1	2412	5.95	10	PASS
		2442	6.38	10	PASS
		2472	6.46	10	PASS
802.11g	Ant1	2412	1.18	10	PASS
		2442	0.11	10	PASS
		2472	1.43	10	PASS
802.11n HT20	Ant1	2412	1.15	10	PASS
		2442	0.84	10	PASS
		2472	1.21	10	PASS

----- The following blanks -----

Test Graphs

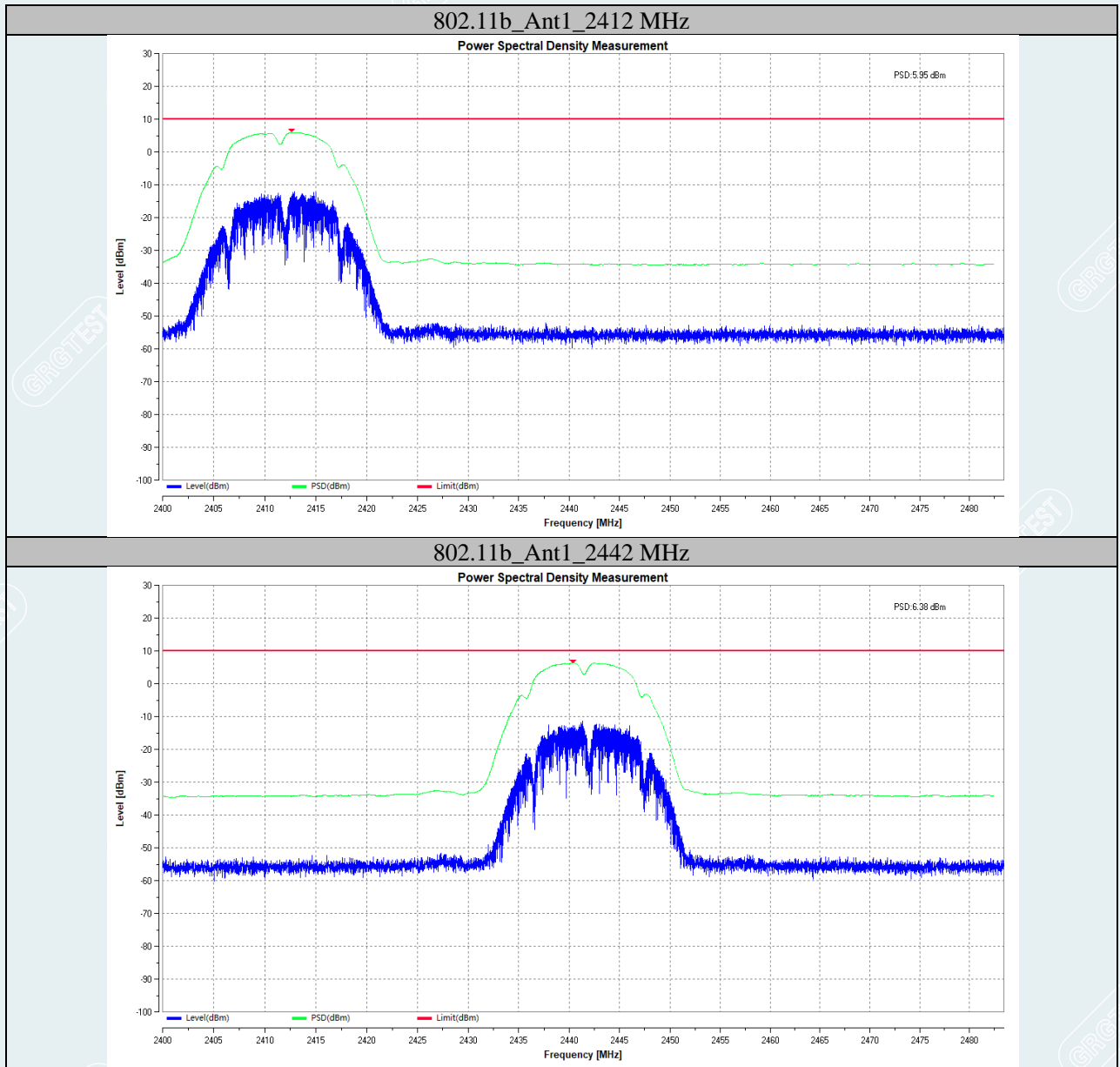

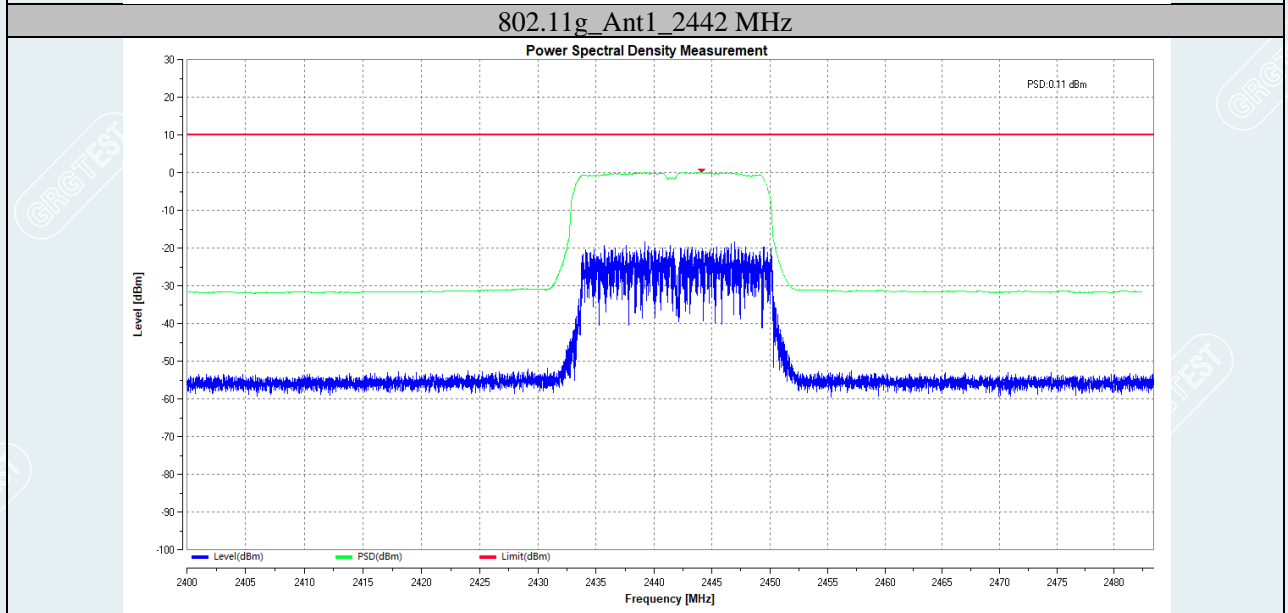
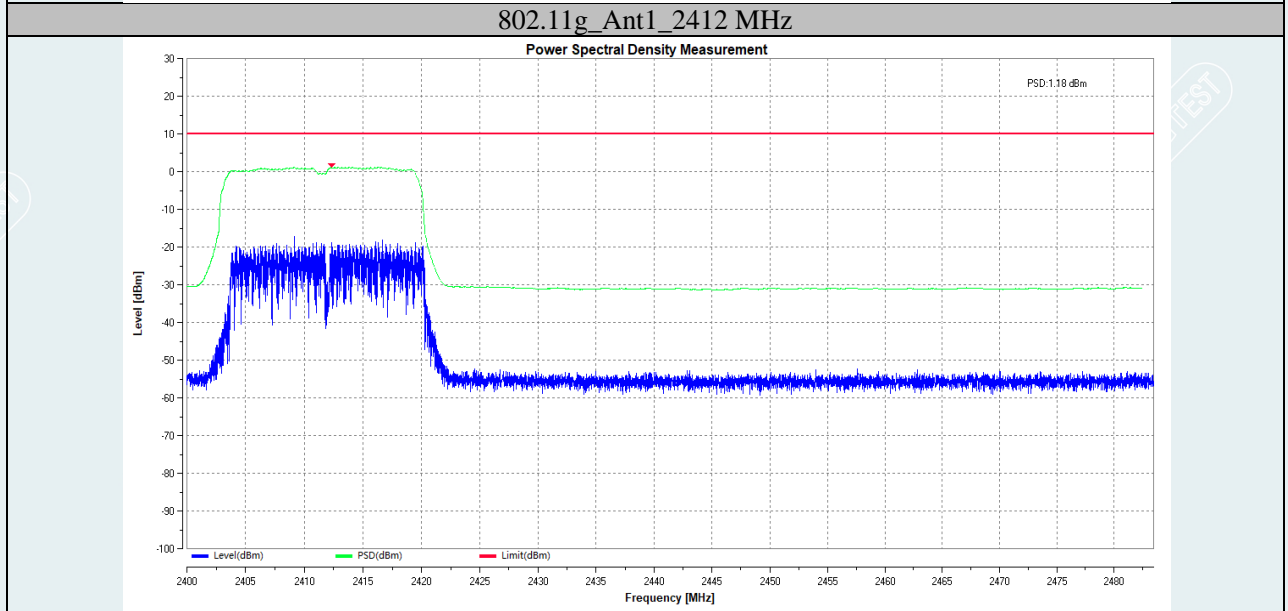
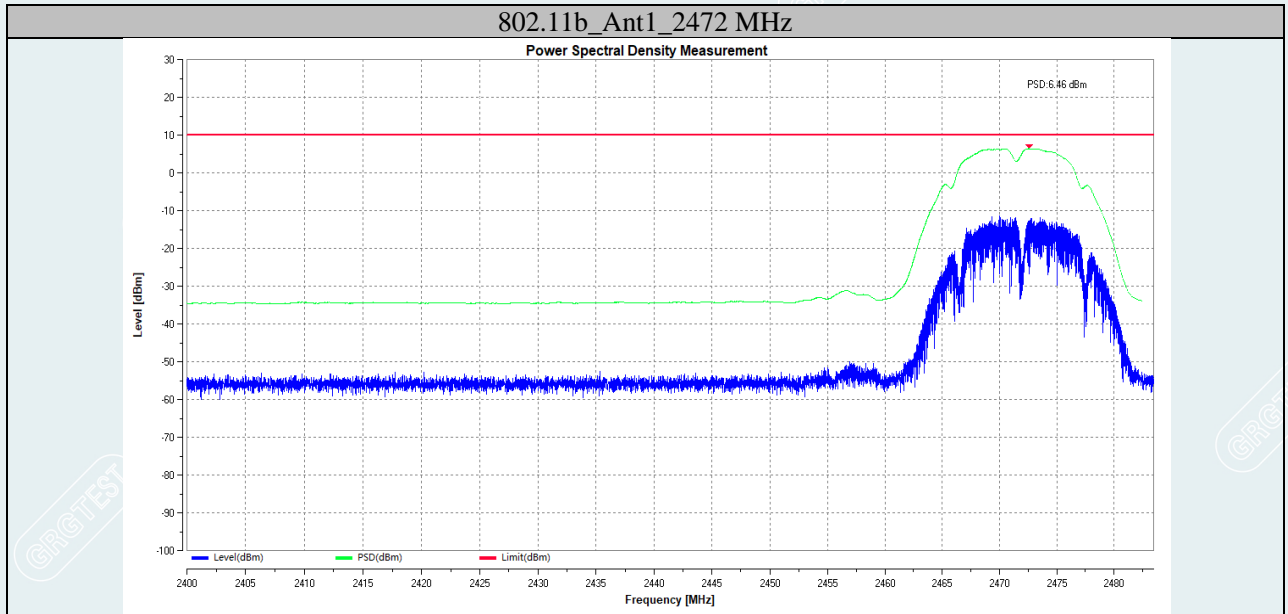

802.11g_Ant1_2472 MHz

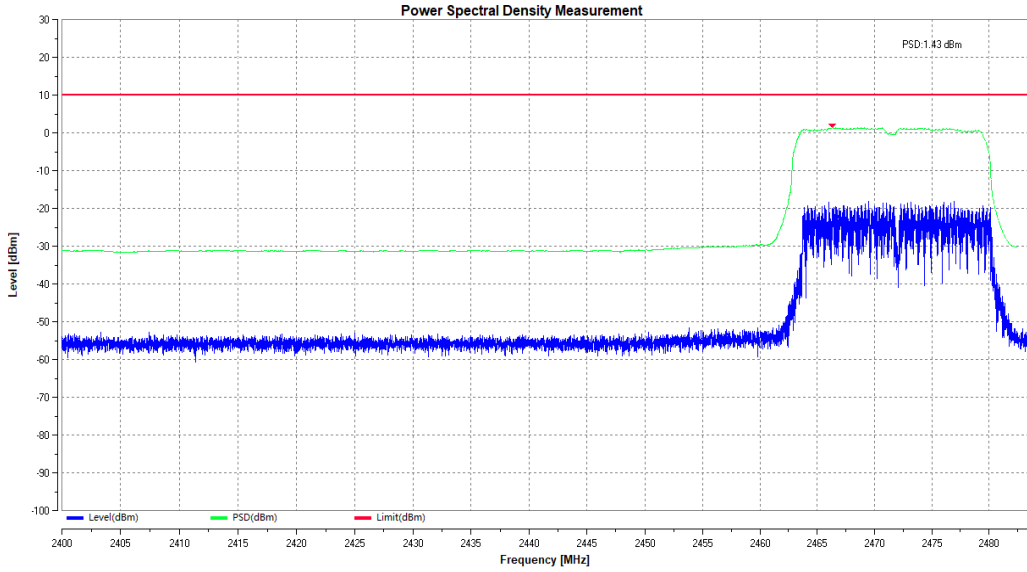

802.11n HT20_Ant1_2412 MHz

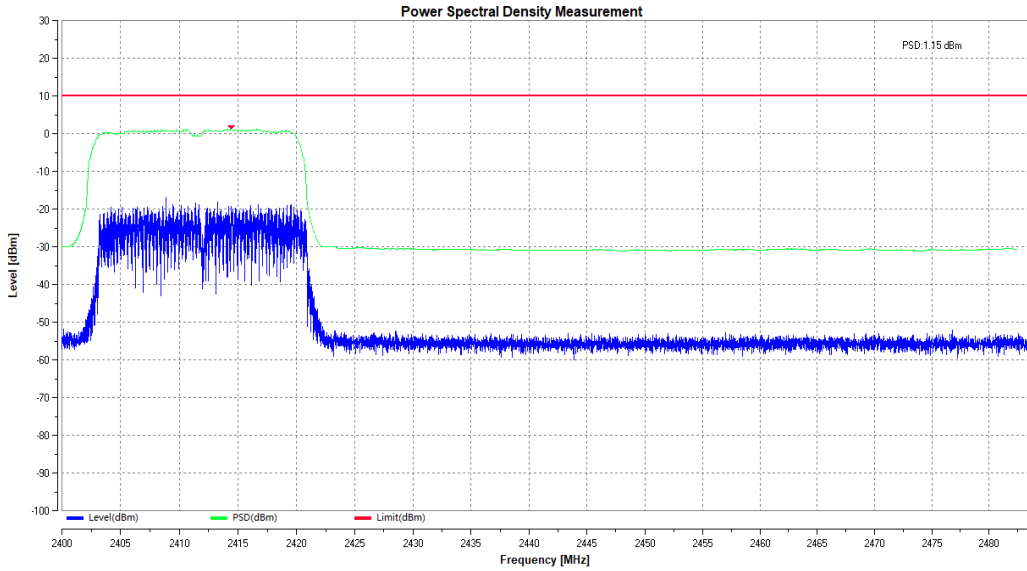

802.11n HT20_Ant1_2442 MHz

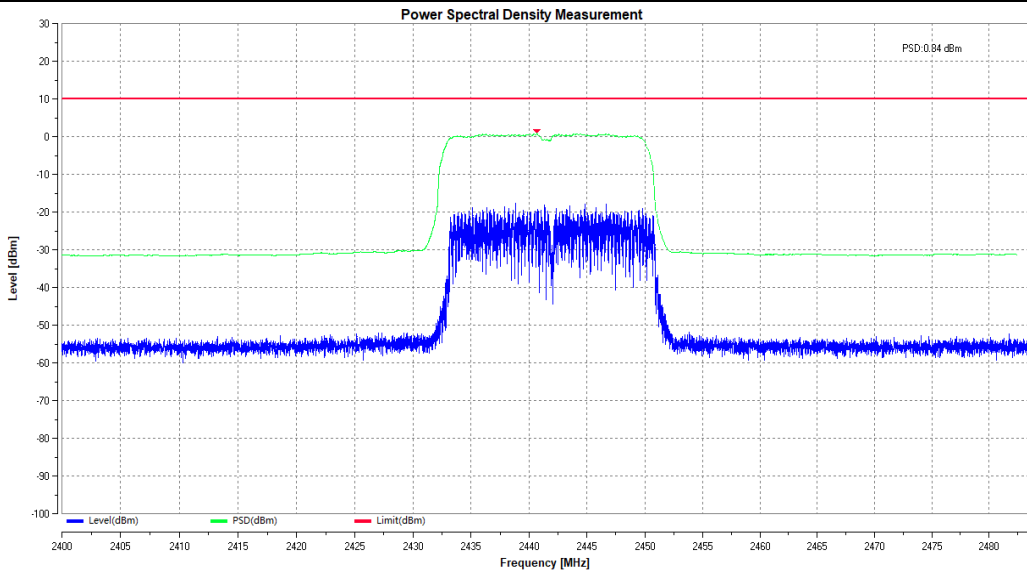

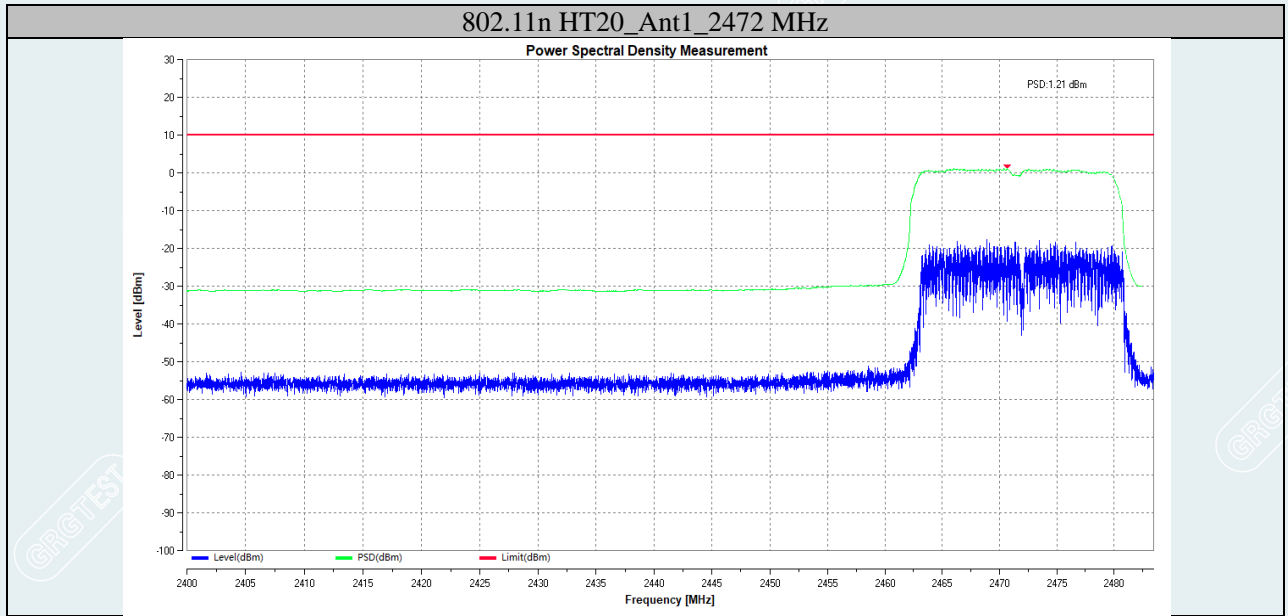

5.3 ADAPTIVITY

Test Requirement: EN300 328 V2.2.2/ 4.3.2.6

Test Method: EN300 328 V2.2.2/5.4.6.2.1

5.3.1 LIMIT

For Adaptive Non-FHSS equipment

Clear Channel Assessment 18us - 160us

Channel Occupancy time < 13ms

Short Control Signaling Transmissions shall have a maximum TxOn/(TxOn+TxOff) ratio of 10% within any observation period of 50ms or within an observation period equal to the dwell time, whichever is less.

5.3.2 TEST CONFIGURATION

Conducted measurement:

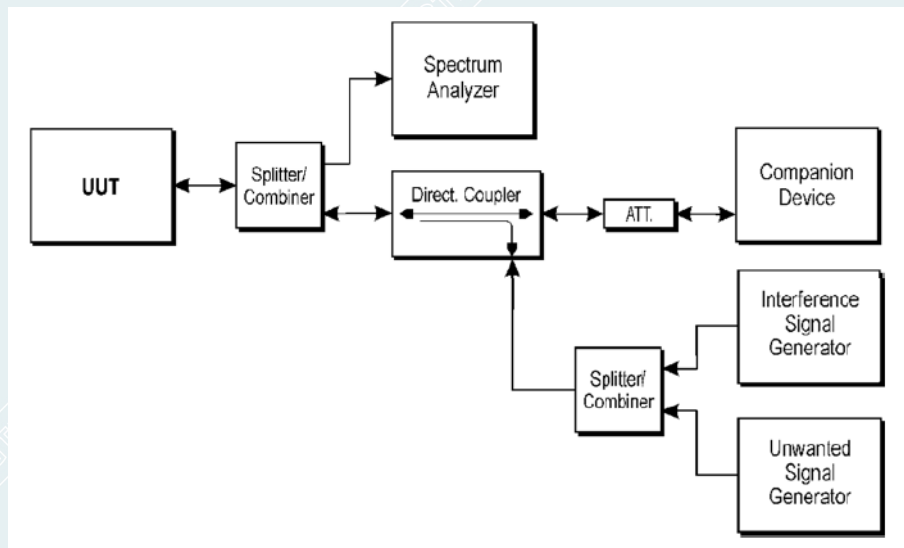

5.3.3 TEST PROCEDURES

Test condition: Normal test conditions

Test channel: 2412MHz, 2472MHz for 802.11b/g/n HT20

Test procedure: Test procedure is according to Clause 5.4.6.2.1 of EN 300 328 V2.2.2

Remark: /

5.3.4 TEST RESULTS

Test environment: Normal condition:
23.8°C/51%RH/101.0kPa

Test Engineer: Qin Tingting

Test Date: 2022-09-26

Test Mode	Antenna	Frequency [MHz]	Max.COT [ms]	Limit[ms]	Min.Idle Time[ms]	Limit[ms]	Verdict
802.11b	Ant1	2412	0.283	13	0.058	0.018	PASS
		2472	0.283	13	0.058	0.018	PASS
802.11g	Ant1	2412	0.283	13	0.058	0.018	PASS
		2472	0.283	13	0.058	0.018	PASS
802.11n HT20	Ant1	2412	1.707	13	0.059	0.018	PASS
		2472	1.230	13	0.059	0.018	PASS

Test Mode	Antenna	Frequency [MHz]	Add Signal Type	Add Signal Time[ms]	Add Signal Level[dbm]	Max.Short Time [%]	Limit [%]	Verdict
802.11b	Ant1	2412	AWGN	3000	-64.48	0.00	10	PASS
			CW	65998	-34.50	0.00	10	PASS
		2472	AWGN	3000	-65.55	1.60	10	PASS
			CW	65998	-34.50	0.00	10	PASS
802.11g	Ant1	2412	AWGN	3000	-62.84	0.00	10	PASS
			CW	65998	-34.50	0.00	10	PASS
		2472	AWGN	3000	-63.05	1.20	10	PASS
			CW	65998	-34.50	0.00	10	PASS
802.11n HT20	Ant1	2412	AWGN	3000	-63.00	0.00	10	PASS
			CW	65998	-34.50	0.00	10	PASS
		2472	AWGN	3000	-62.93	0.00	10	PASS
			CW	65998	-34.50	0.00	10	PASS

----- The following blanks -----

Test Graphs

802.11b

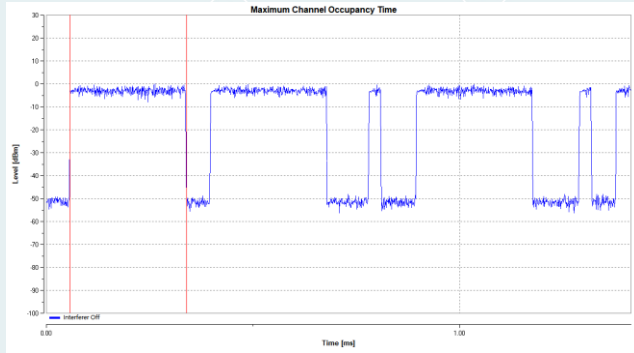

Lowest Frequency: 2412MHz

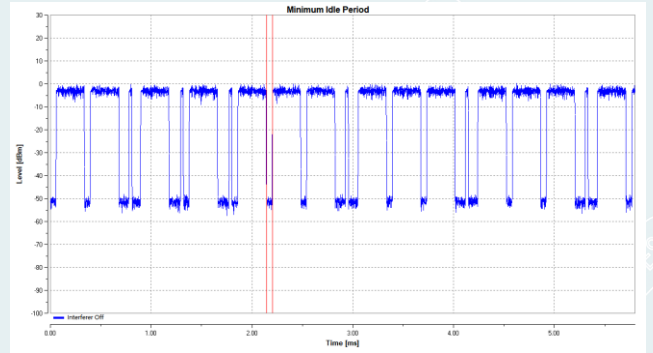

Lowest Frequency: 2412MHz

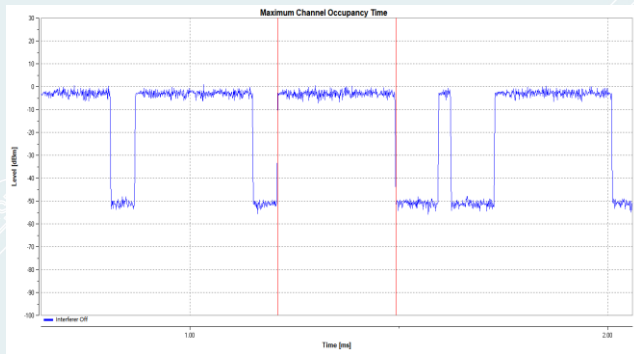

Highest Frequency: 2472MHz

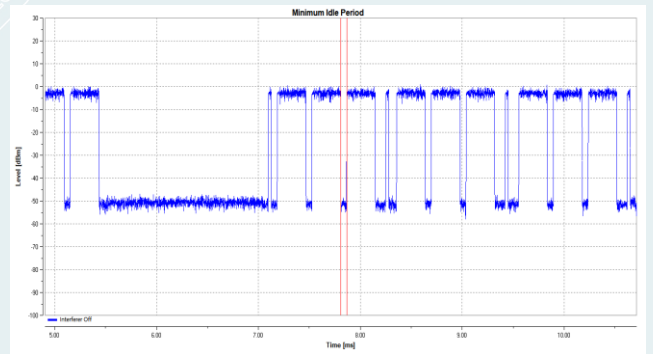

Highest Frequency: 2472MHz

----- The following blanks -----

802.11g

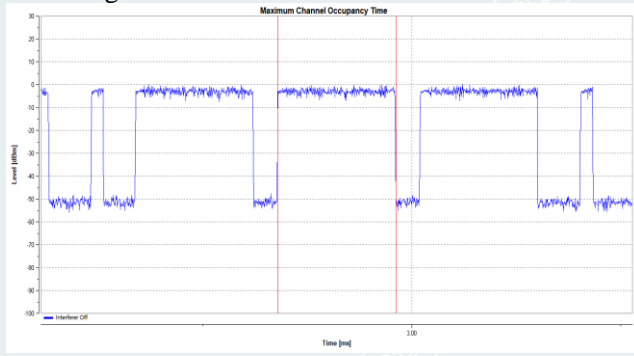

Lowest Frequency: 2412MHz

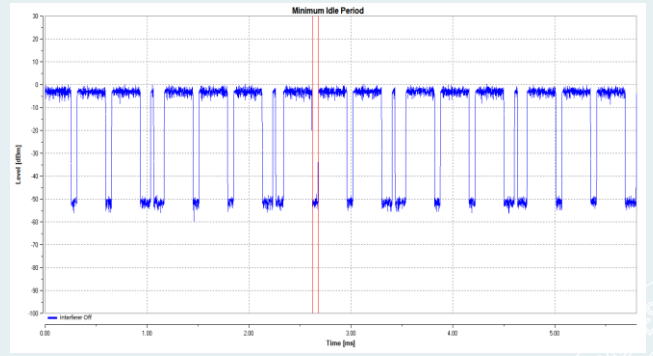

Lowest Frequency: 2412MHz

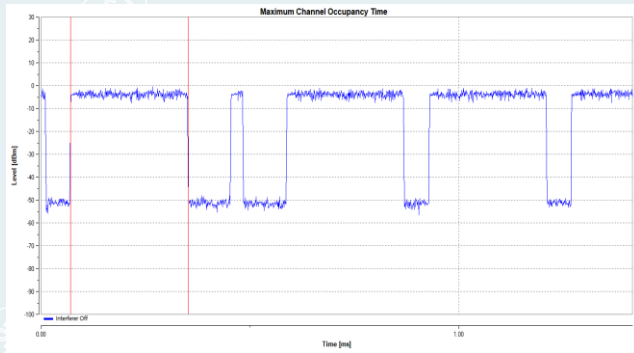

Highest Frequency: 2472MHz

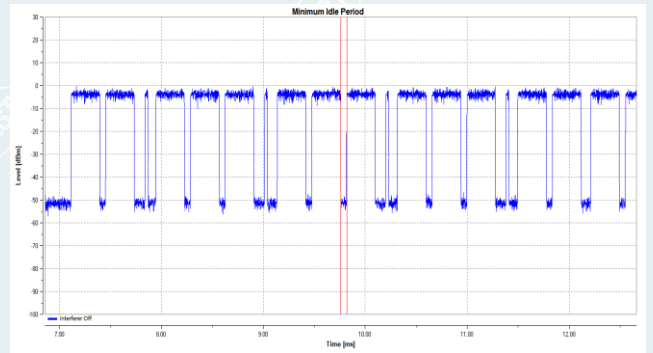

Highest Frequency: 2472MHz

----- The following blanks -----

802.11n20

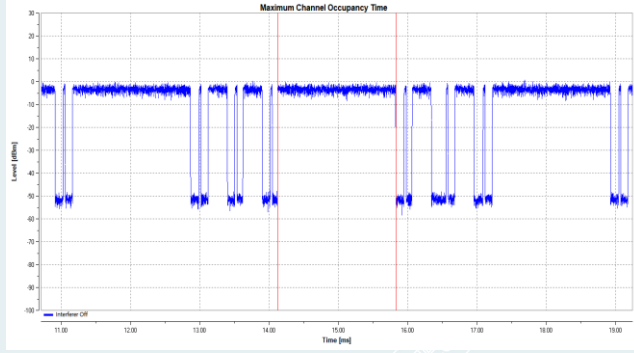

Lowest Frequency: 2412MHz

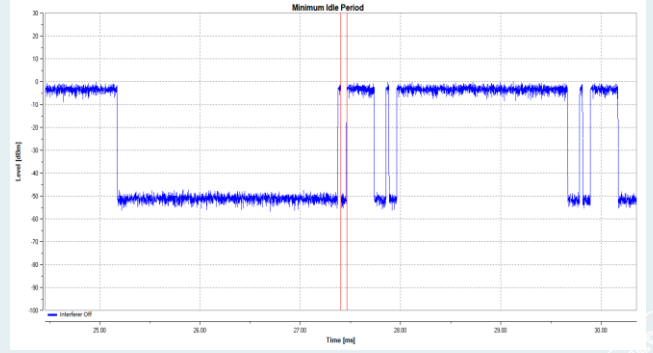

Lowest Frequency: 2412MHz

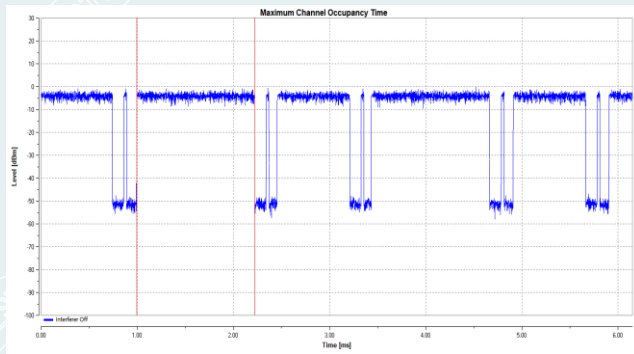

Highest Frequency: 2472MHz

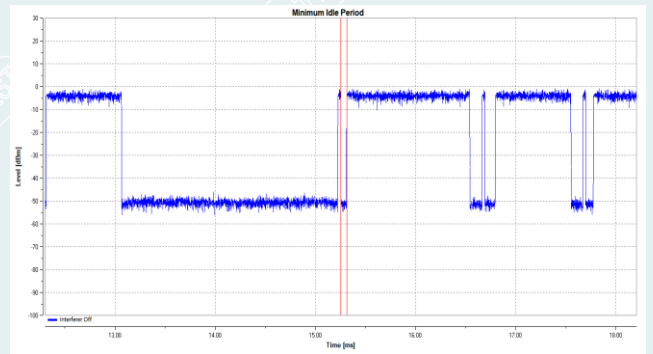

Highest Frequency: 2472MHz

----- The following blanks -----

802.11b

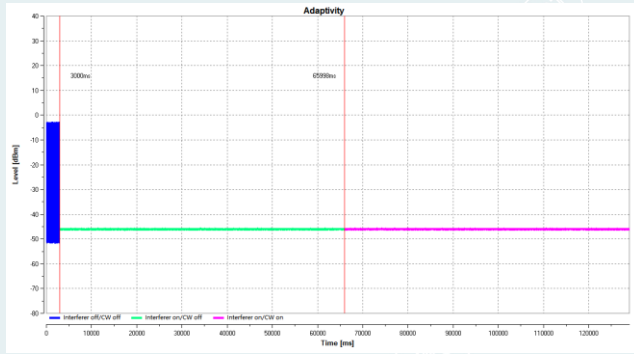

Lowest Frequency: 2412MHz

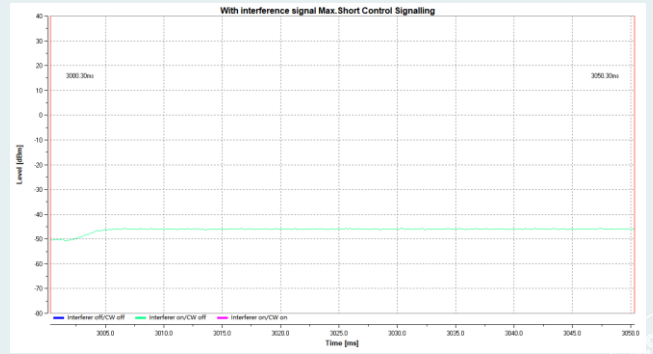

Lowest Frequency: 2412MHz

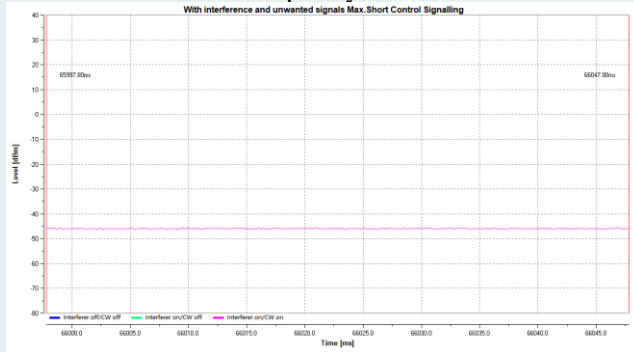

Lowest Frequency: 2412MHz

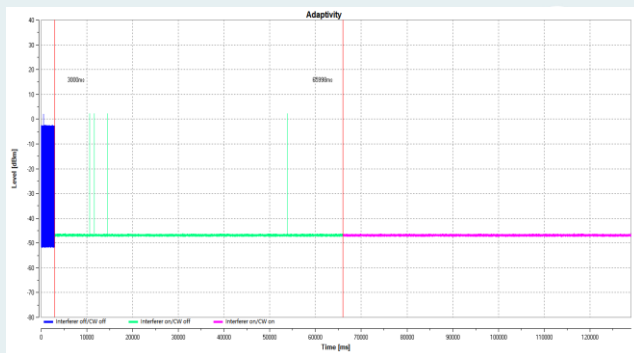

Highest Frequency: 2472MHz

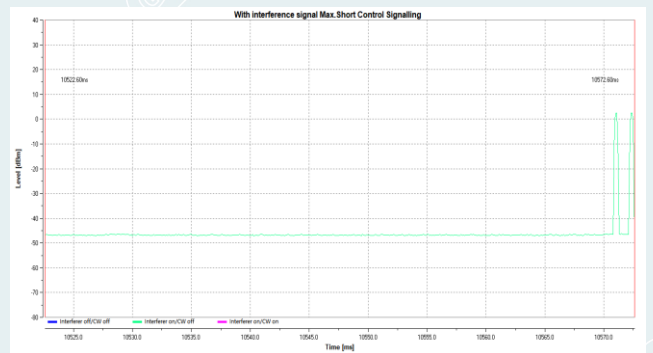

Highest Frequency: 2472MHz

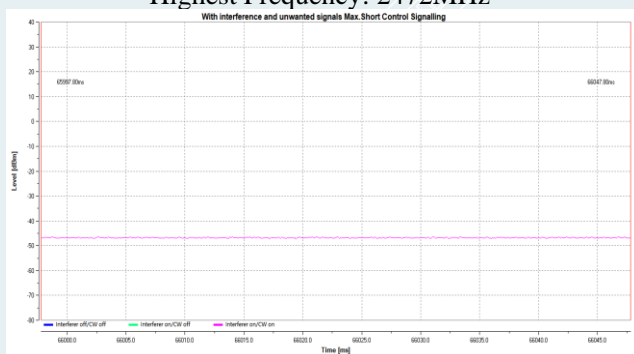

Highest Frequency: 2472MHz

802.11g

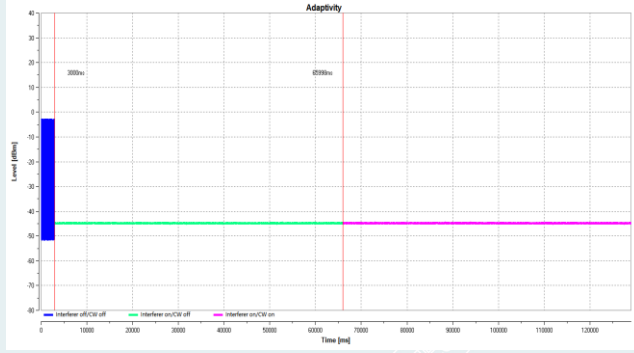

Lowest Frequency: 2412MHz

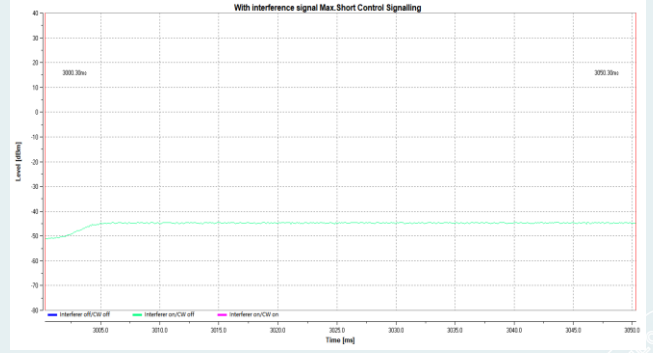

Lowest Frequency: 2412MHz

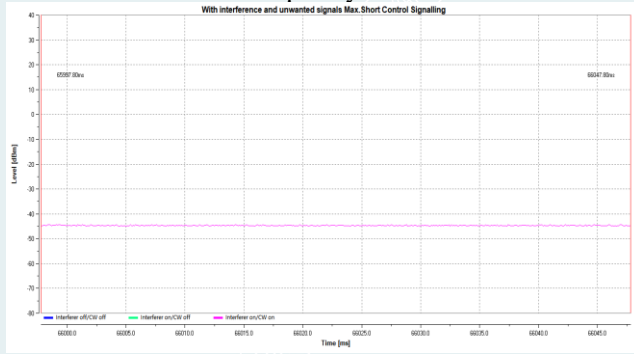

Lowest Frequency: 2412MHz

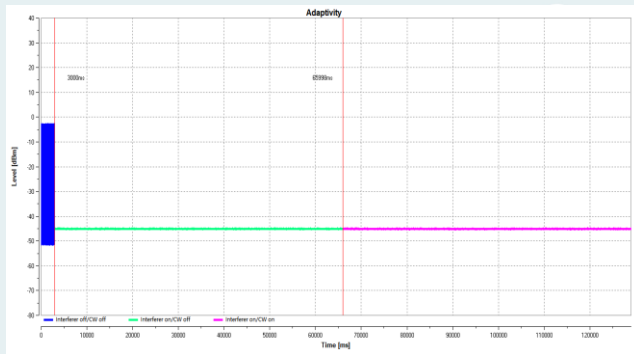

Highest Frequency: 2472MHz

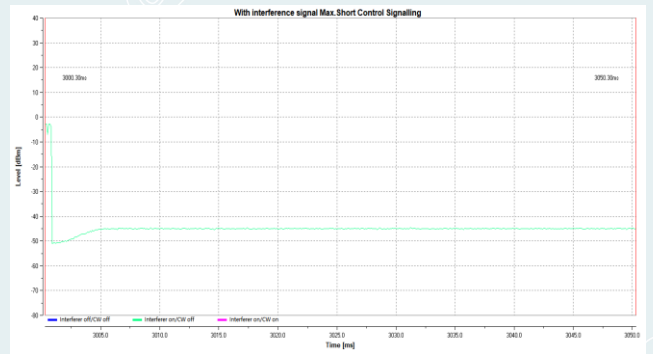

Highest Frequency: 2472MHz

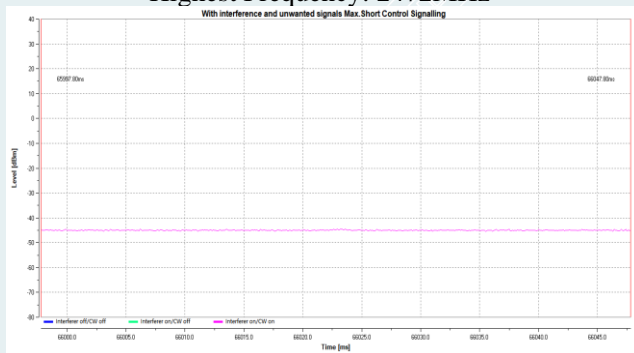

Highest Frequency: 2472MHz

802.11n20

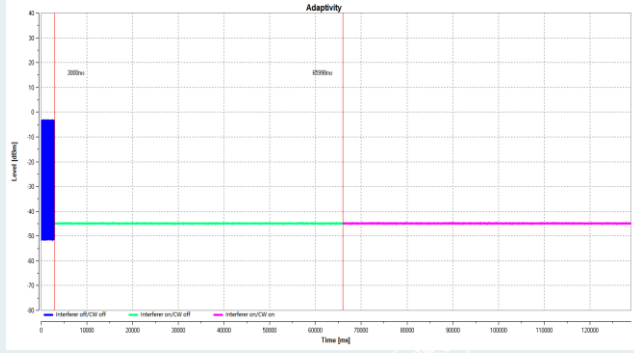

Lowest Frequency: 2412MHz

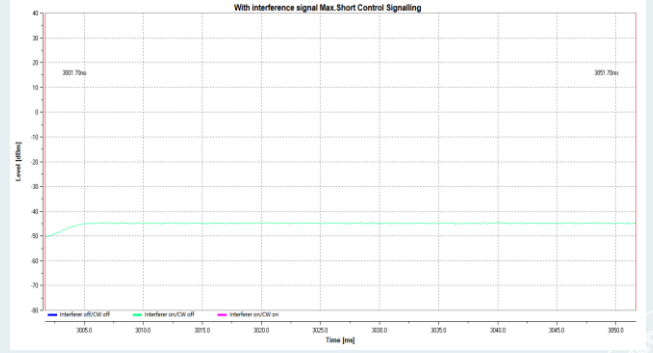

Lowest Frequency: 2412MHz

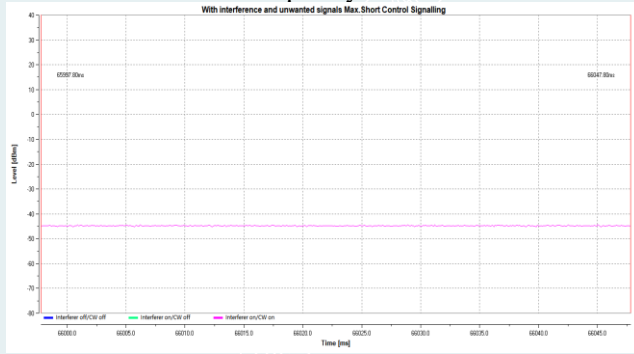

Lowest Frequency: 2412MHz

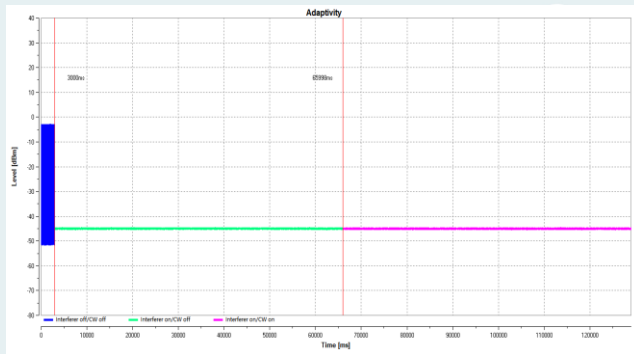

Highest Frequency: 2472MHz

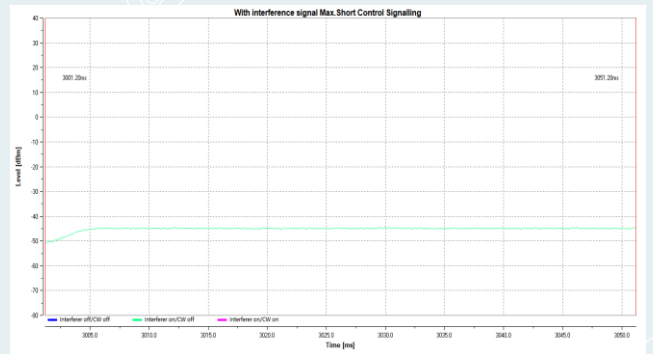

Highest Frequency: 2472MHz

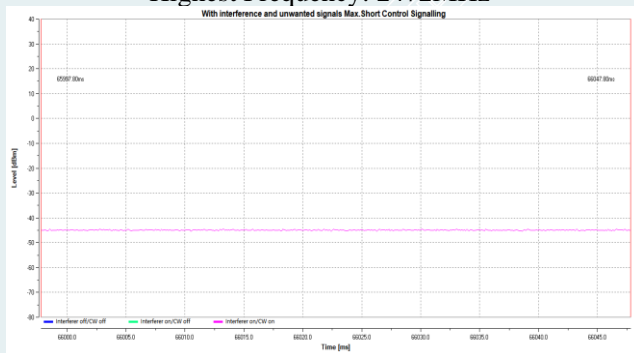

Highest Frequency: 2472MHz

5.4 OCCUPIED CHANNEL BANDWIDTH

Test Requirement: EN300 328 V2.2.2/ 4.3.2.7

Test Method: EN300 328 V2.2.2/5.4.7.2.1

5.4.1 LIMIT

This requirement applies to all types of non-FHSS equipment.

The Occupied Channel Bandwidth shall fall completely within the band given in table 2.

In addition, for non-adaptive equipment using wide band modulations other than FHSS and with e.i.r.p. greater than 10 dBm, the occupied channel bandwidth shall be less than 20 MHz.

Table 2: Service frequency bands

	Service frequency bands
Transmit	2 400 MHz to 2 483,5 MHz
Receive	2 400 MHz to 2 483,5 MHz

5.4.2 TEST CONFIGURATION

Conducted measurement:

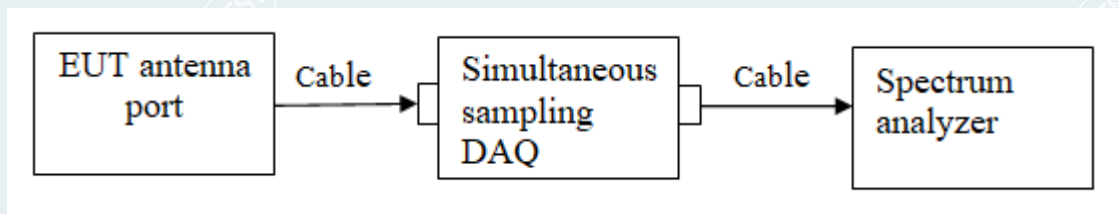

5.4.3 TEST PROCEDURES

Test condition: Normal test conditions.

Test channel: 2412MHz, 2442 MHz, 2472MHz for 802.11b/g/n HT20

Test procedure: Test procedure is according to Clause 5.4.7.2.1 of EN 300 328 V2.2.2

Remark: /

----- The following blanks -----

5.4.4 TEST RESULTS

Test environment: Normal condition:
23.8°C/51%RH/101.0kPa

Test Engineer: Qin Tingting

Test Date: 2022-08-23

Test Mode	Antenna	Frequency [MHz]	OCB[MHz]	FL[MHz]	FH[MHz]	Limit[MHz]	Verdict
802.11b	Ant1	2412	13.385	2405.3215	2418.7065	2400 to 2483.5	PASS
		2442	13.356	2435.3234	2448.6794	2400 to 2483.5	PASS
		2472	13.355	2465.2740	2478.6290	2400 to 2483.5	PASS
802.11g	Ant1	2412	16.572	2403.7018	2420.2738	2400 to 2483.5	PASS
		2442	16.564	2433.7007	2450.2647	2400 to 2483.5	PASS
		2472	16.567	2463.6828	2480.2498	2400 to 2483.5	PASS
802.11n HT20	Ant1	2412	17.635	2403.1750	2420.8100	2400 to 2483.5	PASS
		2442	17.634	2433.1767	2450.8107	2400 to 2483.5	PASS
		2472	17.647	2463.1523	2480.7993	2400 to 2483.5	PASS

----- The following blanks -----

Test Graphs



802.11b_Ant1_2472 MHz

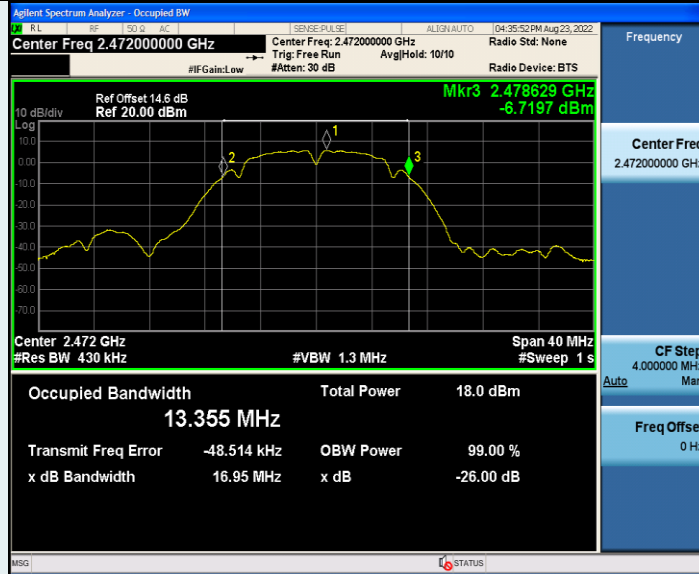

802.11g_Ant1_2412 MHz



802.11g_Ant1_2442 MHz



802.11g_Ant1_2472 MHz

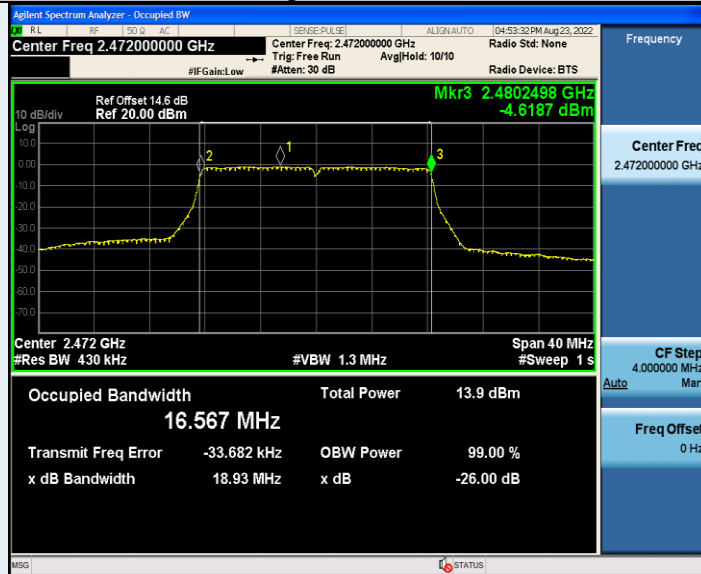

802.11n HT20_Ant1_2412 MHz

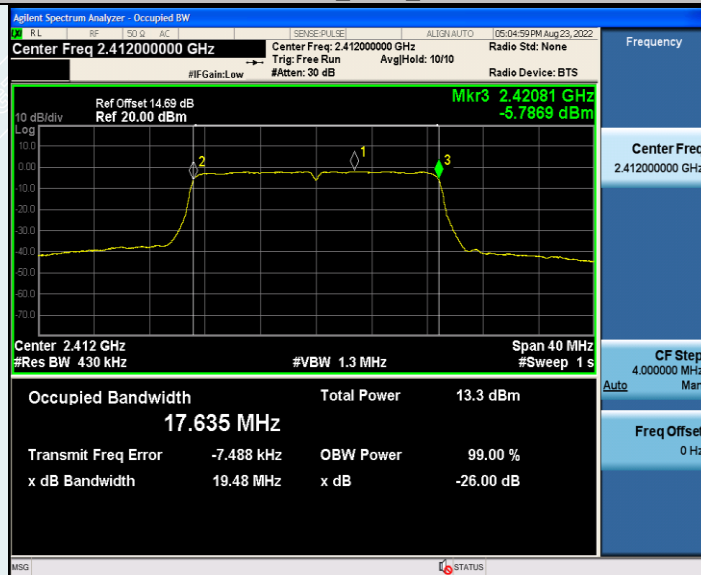

802.11n HT20_Ant1_2442 MHz

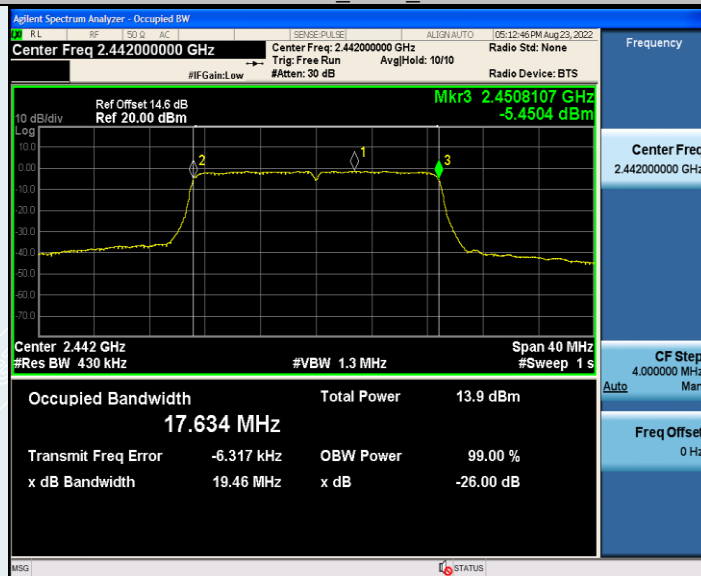

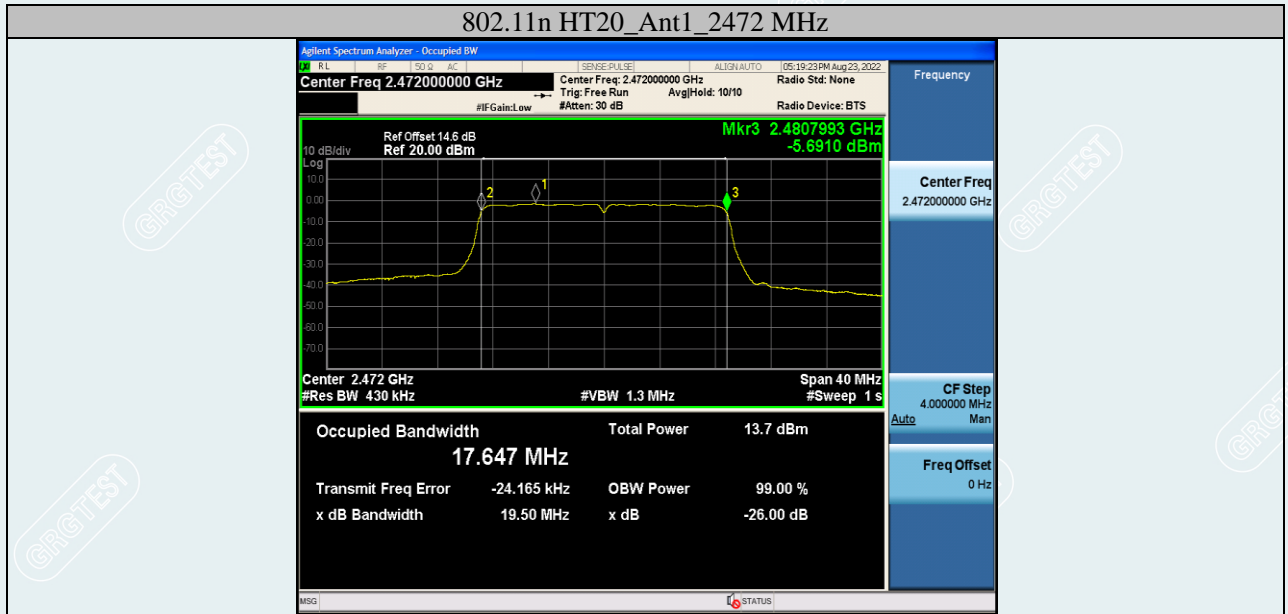

----- The following blanks -----

5.5 TRANSMITTER UNWANTED EMISSIONS IN THE OUT-OF-BAND DOMAIN

Test Requirement: EN300 328 V2.2.2/ 4.3.2.8

Test Method: EN300 328 V2.2.2/5.4.8.2.1

5.5.1 LIMIT

This requirement applies to all types of FHSS equipment and all types of non-FHSS equipment.

The transmitter unwanted emissions in the out-of-band domain but outside the allocated band, shall not exceed the values provided by the mask in figure 3.

Within the band specified in table 3, the Out-of-band emissions are fulfilled by compliance with the Occupied Channel Bandwidth requirement in clause 6.10.1.1 and 6.10.1.2.

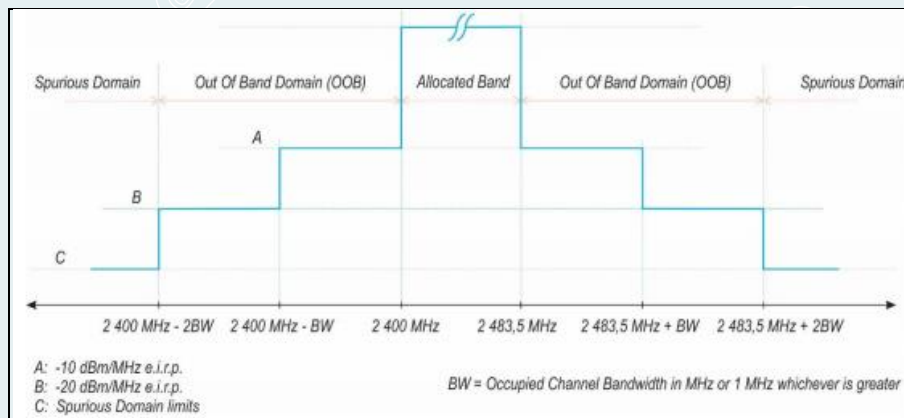

5.5.2 TEST CONFIGURATION

Conducted measurement:

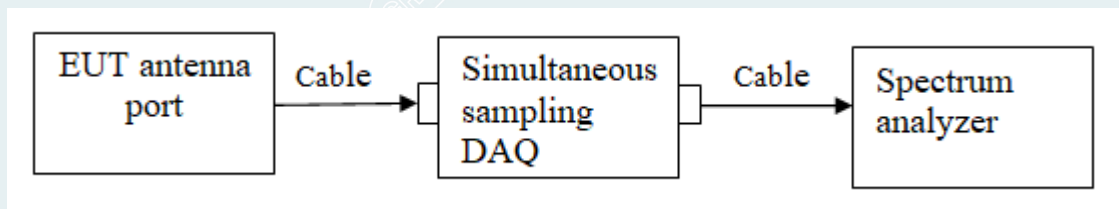

5.5.3 TEST PROCEDURES

Test condition: Normal test conditions.

Test channel: 2412MHz, 2472MHz for 802.11b/g/n HT20

Test procedure: Test procedure is according to Clause 5.4.8.2.1 of EN 300 328 V2.2.2

Remark: /

5.5.4 TEST RESULTS

Test environment: Normal condition:
23.8°C/51%RH/101.0kPa

Test Engineer: Qin Tingting

Test Date: 2022-08-23

Test Mode	Antenna	Frequency [MHz]	Frequency [MHz]	Level[dBm]	Limit[dBm]	Verdict
802.11b	Ant1	2412	2373.73	-43.73	-20.00	PASS
			2374.115	-43.12	-20.00	PASS
			2375.115	-42.13	-20.00	PASS
			2376.115	-42.27	-20.00	PASS
			2377.115	-43.27	-20.00	PASS
			2378.115	-42.66	-20.00	PASS
			2379.115	-42.05	-20.00	PASS
			2380.115	-41.98	-20.00	PASS
			2381.115	-41.35	-20.00	PASS
			2382.115	-42.01	-20.00	PASS
			2383.115	-40.80	-20.00	PASS
			2384.115	-38.93	-20.00	PASS
			2385.115	-36.71	-20.00	PASS
			2386.115	-38.53	-20.00	PASS
			2387.115	-36.21	-10.00	PASS
			2387.5	-38.47	-10.00	PASS
			2388.5	-38.17	-10.00	PASS
			2389.5	-38.45	-10.00	PASS
			2390.5	-36.05	-10.00	PASS
			2391.5	-37.02	-10.00	PASS
			2392.5	-37.99	-10.00	PASS
			2393.5	-35.74	-10.00	PASS
			2394.5	-33.63	-10.00	PASS
			2395.5	-32.14	-10.00	PASS
			2396.5	-29.96	-10.00	PASS
			2397.5	-28.36	-10.00	PASS
			2398.5	-28.99	-10.00	PASS
			2399.5	-32.25	-10.00	PASS
			2484	-44.36	-10.00	PASS
			2485	-44.34	-10.00	PASS
2486	-43.93	-10.00	PASS			
2487	-44.14	-10.00	PASS			
2488	-44.56	-10.00	PASS			
2489	-44.26	-10.00	PASS			
2490	-44.44	-10.00	PASS			

			2491	-44.53	-10.00	PASS
			2492	-44.66	-10.00	PASS
			2493	-44.90	-10.00	PASS
			2494	-44.86	-10.00	PASS
			2495	-43.86	-10.00	PASS
			2496	-45.15	-10.00	PASS
			2496.385	-44.67	-10.00	PASS
			2497.385	-45.22	-20.00	PASS
			2498.385	-44.21	-20.00	PASS
			2499.385	-44.37	-20.00	PASS
			2500.385	-45.12	-20.00	PASS
			2501.385	-45.62	-20.00	PASS
			2502.385	-43.56	-20.00	PASS
			2503.385	-44.52	-20.00	PASS
			2504.385	-45.04	-20.00	PASS
			2505.385	-44.34	-20.00	PASS
			2506.385	-44.07	-20.00	PASS
			2507.385	-43.97	-20.00	PASS
			2508.385	-44.16	-20.00	PASS
			2509.385	-44.21	-20.00	PASS
			2509.77	-44.50	-20.00	PASS
			2373.79	-45.33	-20.00	PASS
			2374.145	-45.53	-20.00	PASS
			2375.145	-45.26	-20.00	PASS
			2376.145	-45.70	-20.00	PASS
			2377.145	-44.58	-20.00	PASS
			2378.145	-45.42	-20.00	PASS
			2379.145	-45.47	-20.00	PASS
			2380.145	-45.73	-20.00	PASS
			2381.145	-45.47	-20.00	PASS
			2382.145	-44.86	-20.00	PASS
			2383.145	-44.82	-20.00	PASS
		2472	2384.145	-45.55	-20.00	PASS
			2385.145	-45.87	-20.00	PASS
			2386.145	-45.14	-20.00	PASS
			2387.145	-45.30	-10.00	PASS
			2387.5	-45.60	-10.00	PASS
			2388.5	-45.83	-10.00	PASS
			2389.5	-45.61	-10.00	PASS
			2390.5	-45.41	-10.00	PASS
			2391.5	-44.39	-10.00	PASS
			2392.5	-45.53	-10.00	PASS
			2393.5	-45.40	-10.00	PASS
			2394.5	-45.14	-10.00	PASS

			2395.5	-44.61	-10.00	PASS
			2396.5	-44.30	-10.00	PASS
			2397.5	-44.55	-10.00	PASS
			2398.5	-44.85	-10.00	PASS
			2399.5	-43.92	-10.00	PASS
			2484	-27.00	-10.00	PASS
			2485	-32.61	-10.00	PASS
			2486	-32.93	-10.00	PASS
			2487	-31.37	-10.00	PASS
			2488	-28.87	-10.00	PASS
			2489	-31.02	-10.00	PASS
			2490	-33.85	-10.00	PASS
			2491	-37.09	-10.00	PASS
			2492	-37.71	-10.00	PASS
			2493	-34.75	-10.00	PASS
			2494	-36.38	-10.00	PASS
			2495	-39.04	-10.00	PASS
			2496	-38.02	-10.00	PASS
			2496.355	-37.53	-10.00	PASS
			2497.355	-36.08	-20.00	PASS
			2498.355	-36.57	-20.00	PASS
			2499.355	-38.05	-20.00	PASS
			2500.355	-38.61	-20.00	PASS
			2501.355	-41.15	-20.00	PASS
			2502.355	-42.05	-20.00	PASS
			2503.355	-41.72	-20.00	PASS
			2504.355	-41.49	-20.00	PASS
			2505.355	-42.29	-20.00	PASS
			2506.355	-42.71	-20.00	PASS
			2507.355	-41.85	-20.00	PASS
			2508.355	-42.37	-20.00	PASS
			2509.355	-42.45	-20.00	PASS
			2509.71	-42.90	-20.00	PASS
802.11g	Ant1	2412	2366.928	-44.62	-20.00	PASS
			2367.356	-43.51	-20.00	PASS
			2367.928	-43.98	-20.00	PASS
			2368.928	-43.12	-20.00	PASS
			2369.928	-43.94	-20.00	PASS
			2370.928	-43.90	-20.00	PASS
			2371.928	-42.89	-20.00	PASS
			2372.928	-42.68	-20.00	PASS
			2373.928	-42.31	-20.00	PASS
			2374.928	-42.25	-20.00	PASS
			2375.928	-42.05	-20.00	PASS

		2376.928	-41.99	-20.00	PASS
		2377.928	-41.78	-20.00	PASS
		2378.928	-42.27	-20.00	PASS
		2379.928	-39.39	-20.00	PASS
		2380.928	-39.67	-20.00	PASS
		2381.928	-38.74	-20.00	PASS
		2382.928	-38.18	-20.00	PASS
		2383.5	-37.83	-10.00	PASS
		2383.928	-36.11	-10.00	PASS
		2384.5	-37.31	-10.00	PASS
		2385.5	-36.66	-10.00	PASS
		2386.5	-35.30	-10.00	PASS
		2387.5	-35.92	-10.00	PASS
		2388.5	-33.25	-10.00	PASS
		2389.5	-29.09	-10.00	PASS
		2390.5	-26.20	-10.00	PASS
		2391.5	-25.29	-10.00	PASS
		2392.5	-23.53	-10.00	PASS
		2393.5	-24.70	-10.00	PASS
		2394.5	-23.84	-10.00	PASS
		2395.5	-18.37	-10.00	PASS
		2396.5	-19.38	-10.00	PASS
		2397.5	-20.61	-10.00	PASS
		2398.5	-19.28	-10.00	PASS
		2399.5	-18.40	-10.00	PASS
		2484	-45.48	-10.00	PASS
		2485	-43.92	-10.00	PASS
		2486	-45.22	-10.00	PASS
		2487	-44.78	-10.00	PASS
		2488	-45.31	-10.00	PASS
		2489	-45.05	-10.00	PASS
		2490	-45.36	-10.00	PASS
		2491	-44.75	-10.00	PASS
		2492	-44.87	-10.00	PASS
		2493	-44.98	-10.00	PASS
		2494	-45.62	-10.00	PASS
		2495	-46.02	-10.00	PASS
		2496	-45.18	-10.00	PASS
		2497	-45.48	-10.00	PASS
		2498	-45.31	-10.00	PASS
		2499	-45.81	-10.00	PASS
		2499.572	-45.60	-10.00	PASS
		2500	-44.68	-10.00	PASS
		2500.572	-44.65	-20.00	PASS

			2501.572	-45.18	-20.00	PASS
			2502.572	-45.37	-20.00	PASS
			2503.572	-45.56	-20.00	PASS
			2504.572	-45.78	-20.00	PASS
			2505.572	-45.66	-20.00	PASS
			2506.572	-44.96	-20.00	PASS
			2507.572	-45.21	-20.00	PASS
			2508.572	-45.16	-20.00	PASS
			2509.572	-45.15	-20.00	PASS
			2510.572	-45.41	-20.00	PASS
			2511.572	-45.29	-20.00	PASS
			2512.572	-44.51	-20.00	PASS
			2513.572	-45.67	-20.00	PASS
			2514.572	-45.37	-20.00	PASS
			2515.572	-45.61	-20.00	PASS
			2516.144	-45.44	-20.00	PASS
			2516.572	-45.44	-20.00	PASS
			2366.933	-46.64	-20.00	PASS
			2367.366	-46.32	-20.00	PASS
			2367.933	-45.52	-20.00	PASS
			2368.933	-46.33	-20.00	PASS
			2369.933	-46.03	-20.00	PASS
			2370.933	-46.47	-20.00	PASS
			2371.933	-46.08	-20.00	PASS
			2372.933	-45.65	-20.00	PASS
			2373.933	-46.28	-20.00	PASS
			2374.933	-45.76	-20.00	PASS
			2375.933	-45.04	-20.00	PASS
			2376.933	-46.00	-20.00	PASS
			2377.933	-44.98	-20.00	PASS
		2472	2378.933	-44.70	-20.00	PASS
			2379.933	-46.36	-20.00	PASS
			2380.933	-44.86	-20.00	PASS
			2381.933	-45.58	-20.00	PASS
			2382.933	-46.39	-20.00	PASS
			2383.5	-46.00	-10.00	PASS
			2383.933	-45.84	-10.00	PASS
			2384.5	-45.67	-10.00	PASS
			2385.5	-45.89	-10.00	PASS
			2386.5	-45.10	-10.00	PASS
			2387.5	-45.20	-10.00	PASS
			2388.5	-46.15	-10.00	PASS
			2389.5	-45.93	-10.00	PASS
			2390.5	-45.31	-10.00	PASS

		2391.5	-45.52	-10.00	PASS
		2392.5	-45.50	-10.00	PASS
		2393.5	-45.48	-10.00	PASS
		2394.5	-45.86	-10.00	PASS
		2395.5	-45.06	-10.00	PASS
		2396.5	-45.61	-10.00	PASS
		2397.5	-44.72	-10.00	PASS
		2398.5	-45.55	-10.00	PASS
		2399.5	-44.94	-10.00	PASS
		2484	-24.63	-10.00	PASS
		2485	-25.73	-10.00	PASS
		2486	-26.43	-10.00	PASS
		2487	-25.91	-10.00	PASS
		2488	-22.48	-10.00	PASS
		2489	-27.82	-10.00	PASS
		2490	-29.22	-10.00	PASS
		2491	-27.18	-10.00	PASS
		2492	-27.69	-10.00	PASS
		2493	-30.92	-10.00	PASS
		2494	-32.73	-10.00	PASS
		2495	-34.31	-10.00	PASS
		2496	-35.22	-10.00	PASS
		2497	-35.17	-10.00	PASS
		2498	-35.96	-10.00	PASS
		2499	-36.63	-10.00	PASS
		2499.567	-36.42	-10.00	PASS
		2500	-37.27	-10.00	PASS
		2500.567	-36.70	-20.00	PASS
		2501.567	-38.54	-20.00	PASS
		2502.567	-38.53	-20.00	PASS
		2503.567	-38.96	-20.00	PASS
		2504.567	-39.50	-20.00	PASS
		2505.567	-40.10	-20.00	PASS
		2506.567	-39.80	-20.00	PASS
		2507.567	-41.31	-20.00	PASS
		2508.567	-41.87	-20.00	PASS
		2509.567	-42.66	-20.00	PASS
		2510.567	-42.74	-20.00	PASS
		2511.567	-42.13	-20.00	PASS
		2512.567	-42.09	-20.00	PASS
		2513.567	-42.75	-20.00	PASS
		2514.567	-43.88	-20.00	PASS
		2515.567	-43.66	-20.00	PASS
		2516.134	-44.77	-20.00	PASS

			2516.567	-43.49	-20.00	PASS
			2364.865	-44.23	-20.00	PASS
			2365.23	-44.57	-20.00	PASS
			2365.865	-43.01	-20.00	PASS
			2366.865	-44.86	-20.00	PASS
			2367.865	-43.17	-20.00	PASS
			2368.865	-44.48	-20.00	PASS
			2369.865	-44.44	-20.00	PASS
			2370.865	-41.56	-20.00	PASS
			2371.865	-42.92	-20.00	PASS
			2372.865	-43.51	-20.00	PASS
			2373.865	-42.75	-20.00	PASS
			2374.865	-42.50	-20.00	PASS
			2375.865	-41.21	-20.00	PASS
			2376.865	-41.88	-20.00	PASS
			2377.865	-41.65	-20.00	PASS
			2378.865	-41.04	-20.00	PASS
			2379.865	-39.49	-20.00	PASS
			2380.865	-39.33	-20.00	PASS
			2381.865	-39.46	-20.00	PASS
			2382.5	-37.03	-10.00	PASS
			2382.865	-35.94	-10.00	PASS
802.11n HT20	Ant1	2412	2383.5	-36.26	-10.00	PASS
			2384.5	-36.26	-10.00	PASS
			2385.5	-37.38	-10.00	PASS
			2386.5	-34.56	-10.00	PASS
			2387.5	-33.28	-10.00	PASS
			2388.5	-29.36	-10.00	PASS
			2389.5	-26.72	-10.00	PASS
			2390.5	-23.94	-10.00	PASS
			2391.5	-26.68	-10.00	PASS
			2392.5	-24.20	-10.00	PASS
			2393.5	-19.39	-10.00	PASS
			2394.5	-21.45	-10.00	PASS
			2395.5	-18.67	-10.00	PASS
			2396.5	-20.06	-10.00	PASS
			2397.5	-19.46	-10.00	PASS
			2398.5	-19.43	-10.00	PASS
			2399.5	-20.57	-10.00	PASS
			2484	-46.04	-10.00	PASS
			2485	-45.27	-10.00	PASS
			2486	-45.55	-10.00	PASS
			2487	-44.89	-10.00	PASS
			2488	-44.47	-10.00	PASS

			2489	-44.69	-10.00	PASS
			2490	-45.30	-10.00	PASS
			2491	-46.07	-10.00	PASS
			2492	-45.61	-10.00	PASS
			2493	-45.75	-10.00	PASS
			2494	-46.04	-10.00	PASS
			2495	-45.67	-10.00	PASS
			2496	-44.26	-10.00	PASS
			2497	-45.60	-10.00	PASS
			2498	-46.17	-10.00	PASS
			2499	-45.89	-10.00	PASS
			2500	-44.67	-10.00	PASS
			2500.635	-45.52	-10.00	PASS
			2501	-45.35	-10.00	PASS
			2501.635	-45.49	-20.00	PASS
			2502.635	-45.32	-20.00	PASS
			2503.635	-45.23	-20.00	PASS
			2504.635	-46.20	-20.00	PASS
			2505.635	-45.66	-20.00	PASS
			2506.635	-44.83	-20.00	PASS
			2507.635	-45.52	-20.00	PASS
			2508.635	-45.57	-20.00	PASS
			2509.635	-45.57	-20.00	PASS
			2510.635	-45.55	-20.00	PASS
			2511.635	-45.62	-20.00	PASS
			2512.635	-45.05	-20.00	PASS
			2513.635	-44.89	-20.00	PASS
			2514.635	-45.33	-20.00	PASS
			2515.635	-44.82	-20.00	PASS
			2516.635	-45.89	-20.00	PASS
			2517.635	-45.81	-20.00	PASS
			2518.27	-45.81	-20.00	PASS
			2518.635	-45.80	-20.00	PASS
		2472	2364.853	-46.34	-20.00	PASS
		2472	2365.206	-45.51	-20.00	PASS
		2472	2365.853	-46.37	-20.00	PASS
		2472	2366.853	-46.62	-20.00	PASS
		2472	2367.853	-46.24	-20.00	PASS
		2472	2368.853	-45.61	-20.00	PASS
		2472	2369.853	-46.13	-20.00	PASS
		2472	2370.853	-45.36	-20.00	PASS
		2472	2371.853	-45.85	-20.00	PASS
		2472	2372.853	-45.73	-20.00	PASS
		2472	2373.853	-45.59	-20.00	PASS

		2374.853	-45.87	-20.00	PASS
		2375.853	-45.77	-20.00	PASS
		2376.853	-45.63	-20.00	PASS
		2377.853	-45.85	-20.00	PASS
		2378.853	-45.76	-20.00	PASS
		2379.853	-45.51	-20.00	PASS
		2380.853	-46.23	-20.00	PASS
		2381.853	-46.30	-20.00	PASS
		2382.5	-45.89	-10.00	PASS
		2382.853	-45.78	-10.00	PASS
		2383.5	-43.90	-10.00	PASS
		2384.5	-45.98	-10.00	PASS
		2385.5	-46.46	-10.00	PASS
		2386.5	-45.93	-10.00	PASS
		2387.5	-45.84	-10.00	PASS
		2388.5	-45.32	-10.00	PASS
		2389.5	-44.67	-10.00	PASS
		2390.5	-44.80	-10.00	PASS
		2391.5	-45.45	-10.00	PASS
		2392.5	-45.40	-10.00	PASS
		2393.5	-45.46	-10.00	PASS
		2394.5	-45.51	-10.00	PASS
		2395.5	-45.84	-10.00	PASS
		2396.5	-44.54	-10.00	PASS
		2397.5	-45.84	-10.00	PASS
		2398.5	-45.53	-10.00	PASS
		2399.5	-45.22	-10.00	PASS
		2484	-23.33	-10.00	PASS
		2485	-24.68	-10.00	PASS
		2486	-23.09	-10.00	PASS
		2487	-23.33	-10.00	PASS
		2488	-26.00	-10.00	PASS
		2489	-25.86	-10.00	PASS
		2490	-26.71	-10.00	PASS
		2491	-25.48	-10.00	PASS
		2492	-29.72	-10.00	PASS
		2493	-31.16	-10.00	PASS
		2494	-31.06	-10.00	PASS
		2495	-33.12	-10.00	PASS
		2496	-33.10	-10.00	PASS
		2497	-34.96	-10.00	PASS
		2498	-35.54	-10.00	PASS
		2499	-35.71	-10.00	PASS
		2500	-36.98	-10.00	PASS

		2500.647	-36.33	-10.00	PASS
		2501	-37.54	-10.00	PASS
		2501.647	-37.71	-20.00	PASS
		2502.647	-37.61	-20.00	PASS
		2503.647	-37.72	-20.00	PASS
		2504.647	-37.67	-20.00	PASS
		2505.647	-38.17	-20.00	PASS
		2506.647	-39.86	-20.00	PASS
		2507.647	-41.28	-20.00	PASS
		2508.647	-41.21	-20.00	PASS
		2509.647	-40.96	-20.00	PASS
		2510.647	-41.94	-20.00	PASS
		2511.647	-41.59	-20.00	PASS
		2512.647	-41.43	-20.00	PASS
		2513.647	-42.45	-20.00	PASS
		2514.647	-43.58	-20.00	PASS
		2515.647	-42.88	-20.00	PASS
		2516.647	-43.36	-20.00	PASS
		2517.647	-43.40	-20.00	PASS
		2518.294	-43.96	-20.00	PASS
		2518.647	-43.92	-20.00	PASS

----- The following blanks -----

Test Graphs

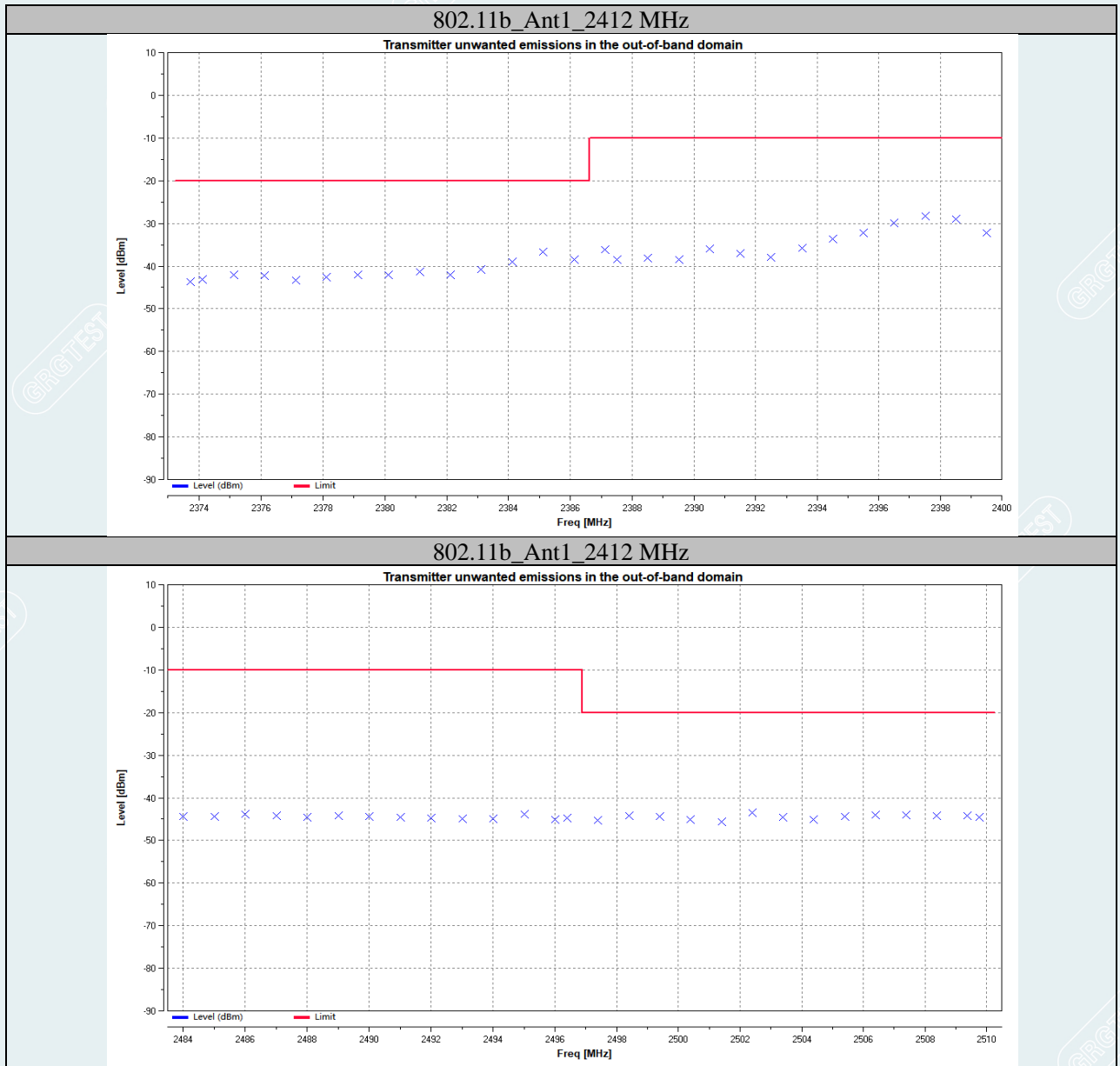

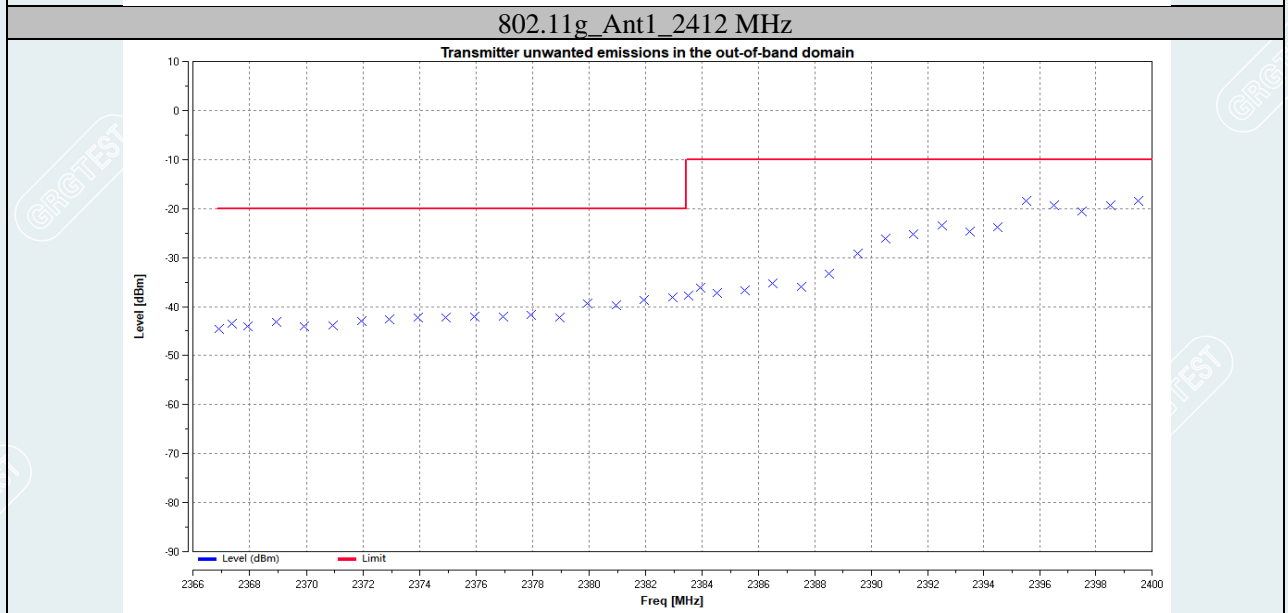
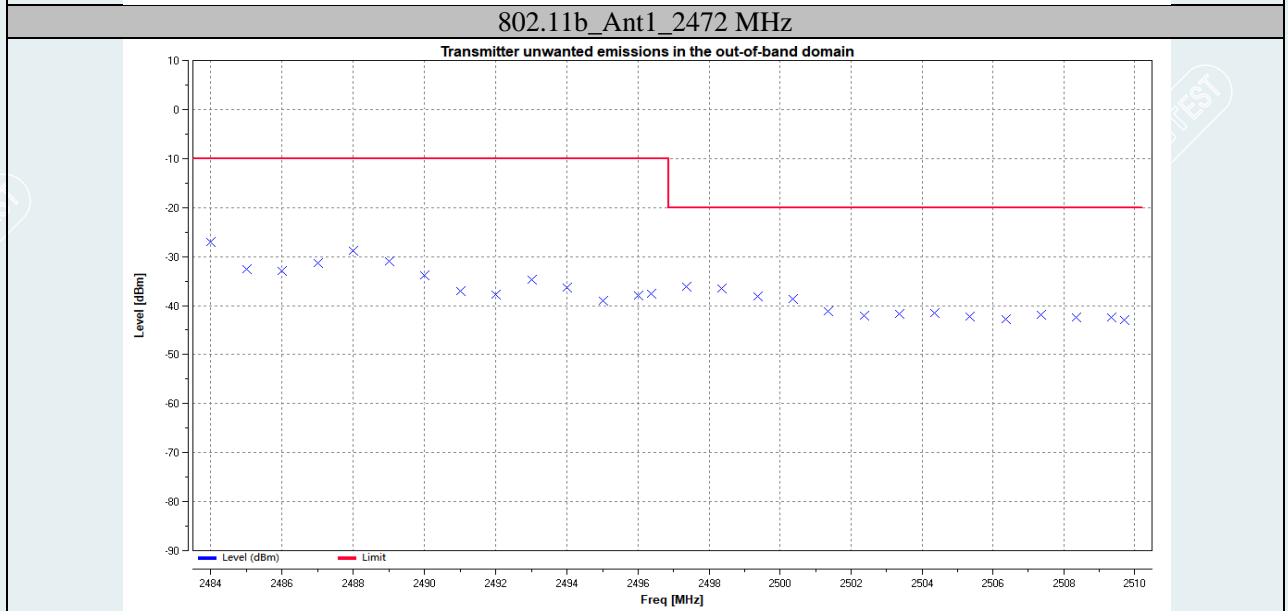
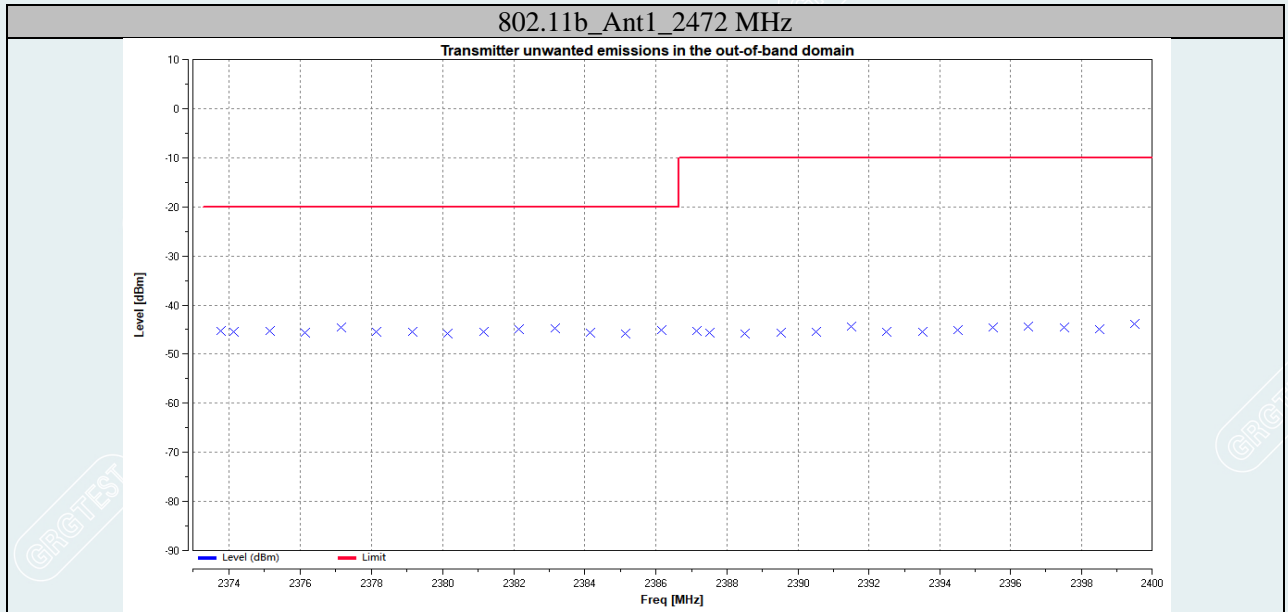

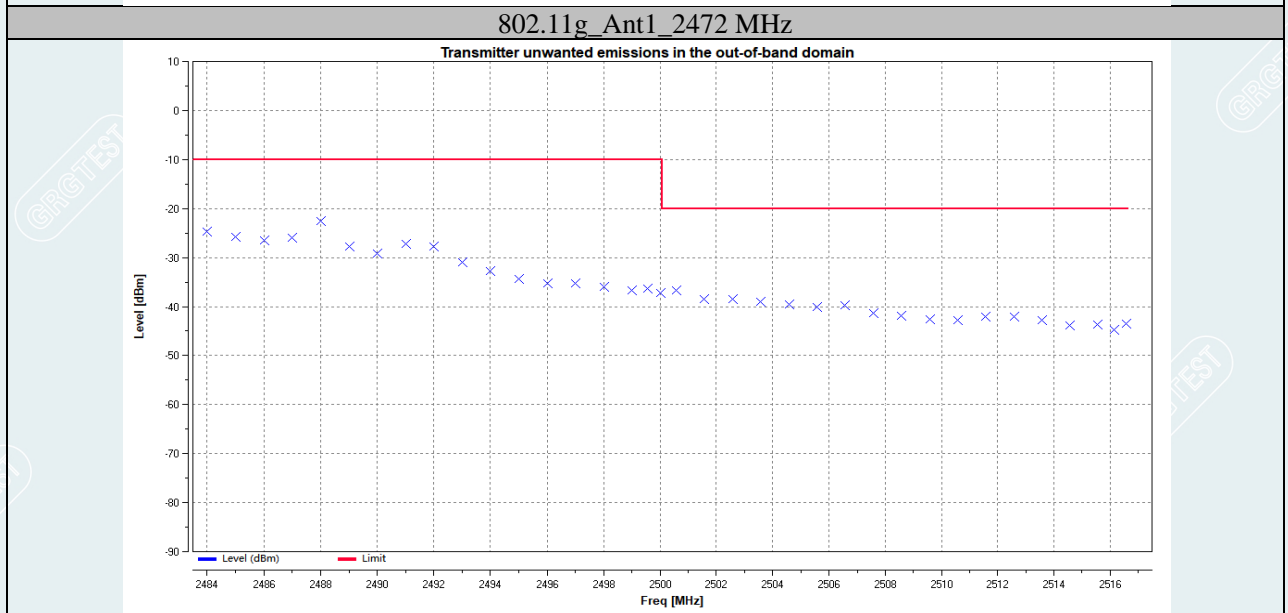
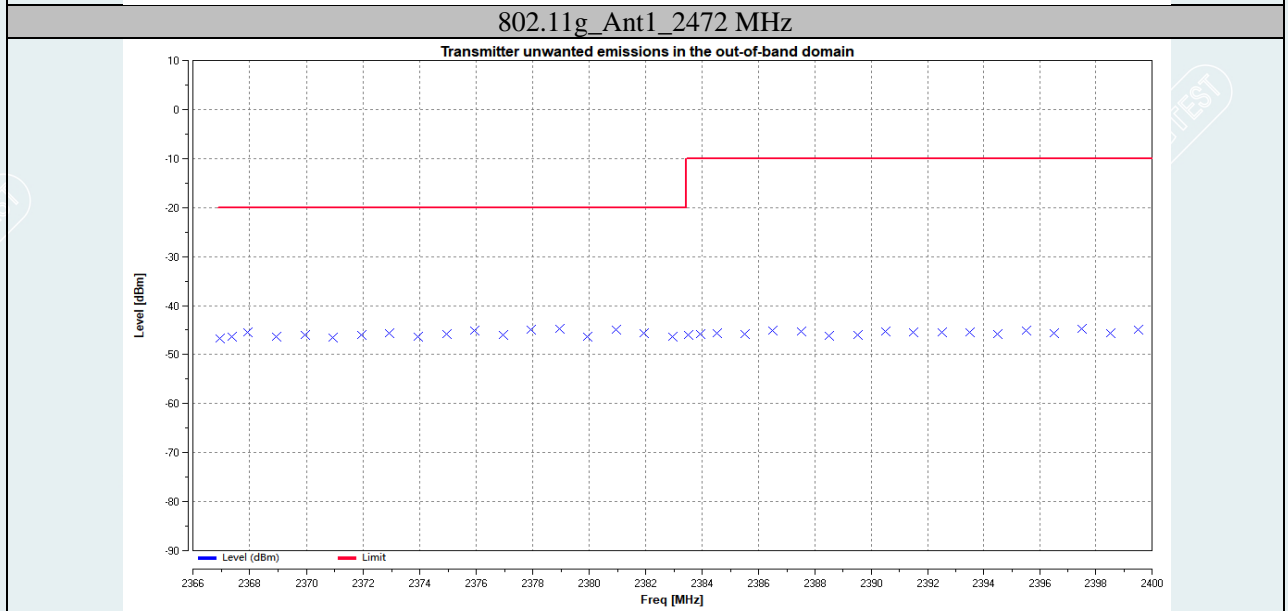
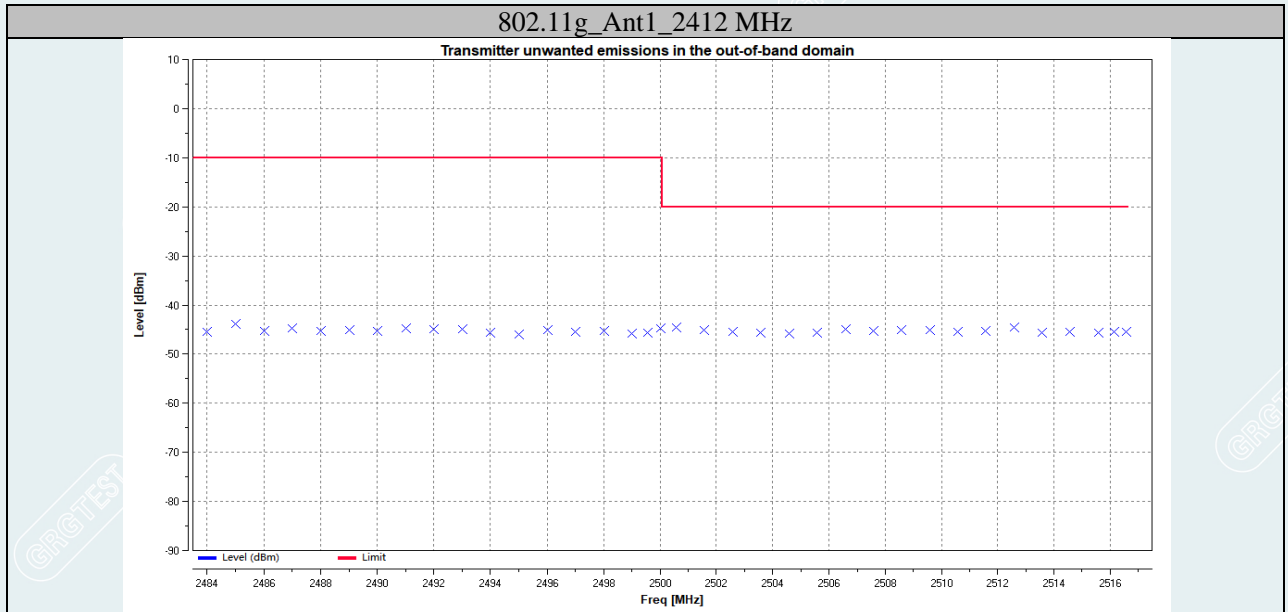

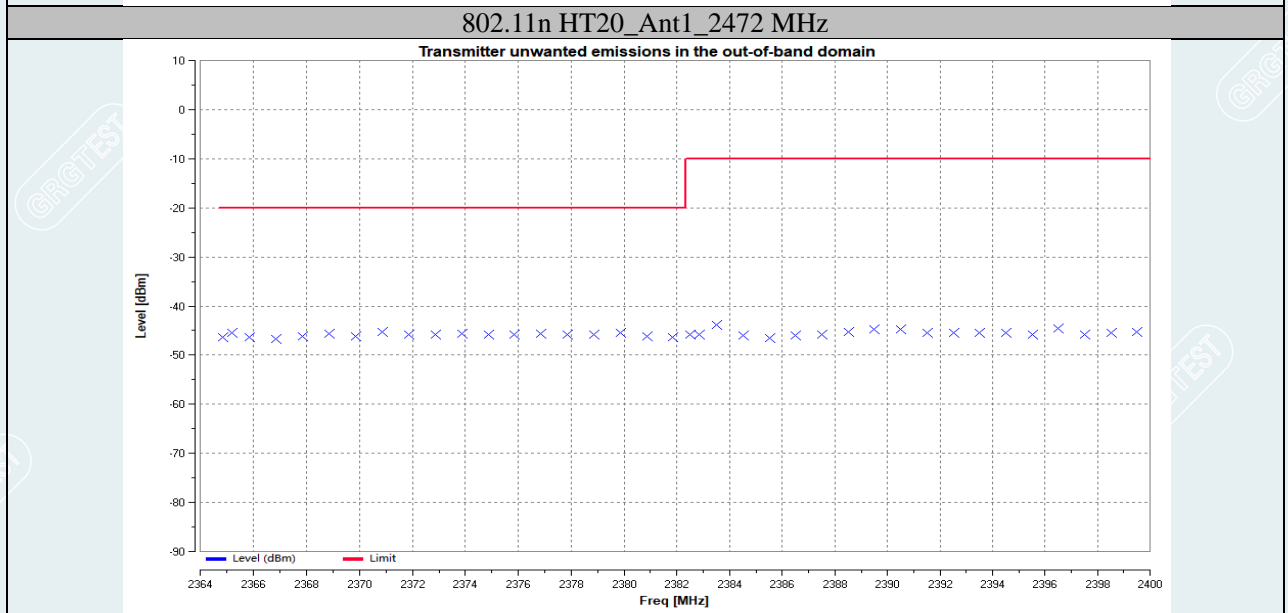
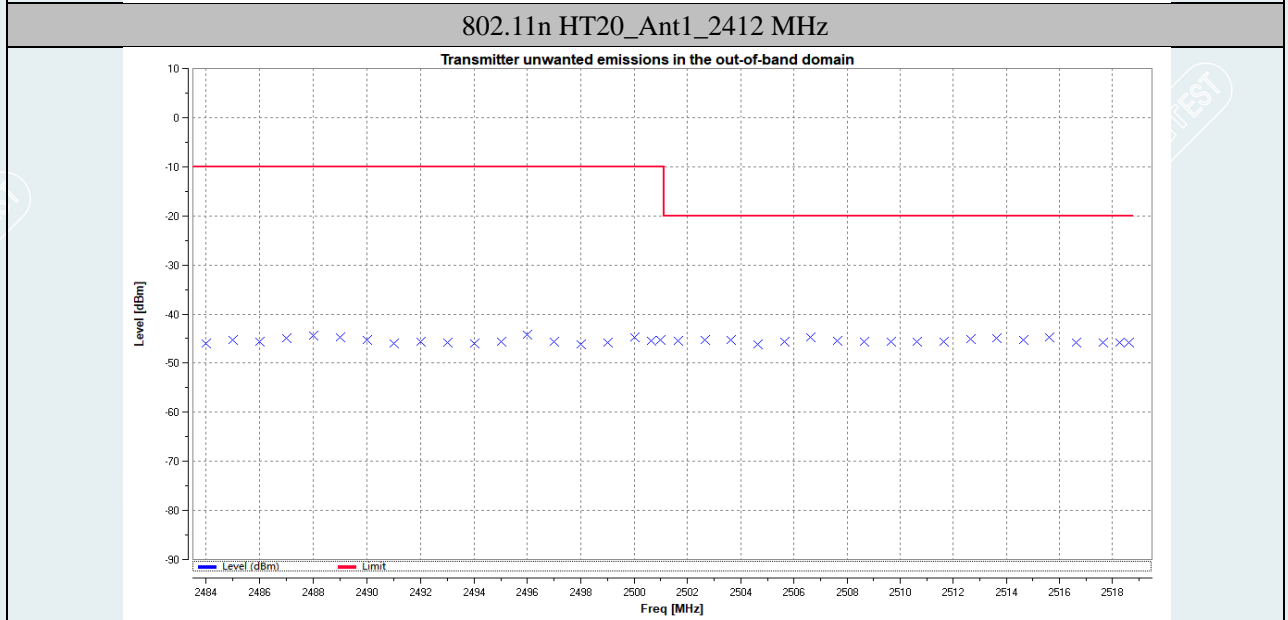
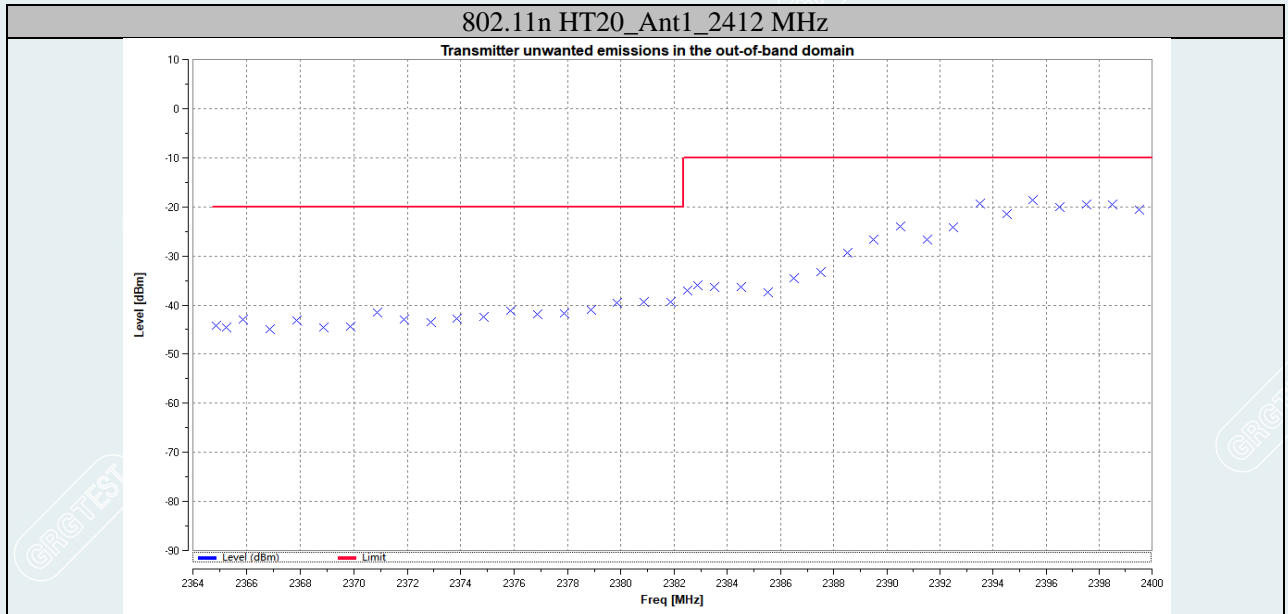

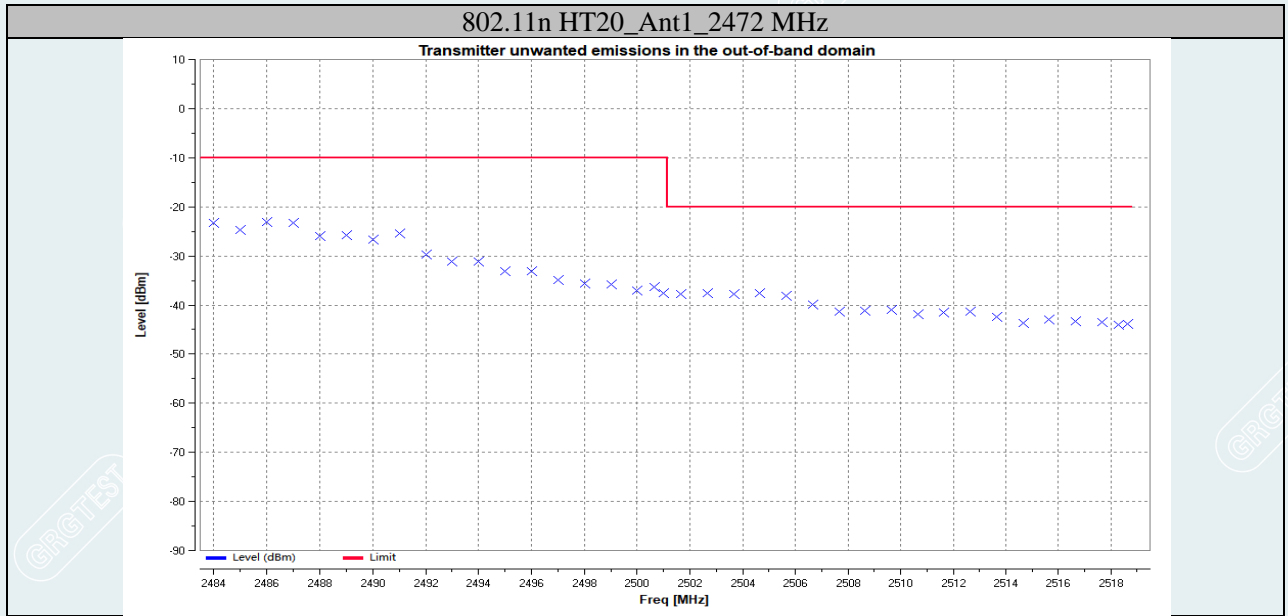

----- The following blanks -----

5.6 TRANSMITTER UNWANTED EMISSIONS IN THE SPURIOUS DOMAIN

Test Requirement: EN300 328 V2.2.2/ 4.3.2.9

Test Method: EN300 328 V2.2.2/5.4.9.2.2

5.6.1 LIMIT

This requirement applies to all types of FHSS equipment and all types of non-FHSS equipment.

The transmitter unwanted emissions in the spurious domain shall not exceed the values given in table 2. In case of equipment with antenna connectors, these limits apply to emissions at the antenna port (conducted). For emissions radiated by the cabinet or emissions radiated by integral antenna equipment (without antenna connectors), these limits are e.r.p. for emissions up to 1 GHz and as e.i.r.p. for emissions above 1 GHz.

Note: This test uses conducted emissions measurement and Radiated emissions measurement.

Table 2: Transmitter limits for spurious emissions

Frequency range	Maximum power	Bandwidth
30 MHz to 47 MHz	-36 dBm	100 kHz
47 MHz to 74 MHz	-54 dBm	100 kHz
74 MHz to 87,5 MHz	-36 dBm	100 kHz
87,5 MHz to 118 MHz	-54 dBm	100 kHz
118 MHz to 174 MHz	-36 dBm	100 kHz
174 MHz to 230 MHz	-54 dBm	100 kHz
230 MHz to 470 MHz	-36 dBm	100 kHz
470 MHz to 694 MHz	-54 dBm	100 kHz
694 MHz to 1 GHz	-36 dBm	100 kHz
1 GHz to 12,75 GHz	-30 dBm	1 MHz

5.6.2 TEST CONFIGURATION

30MHz~1000MHz

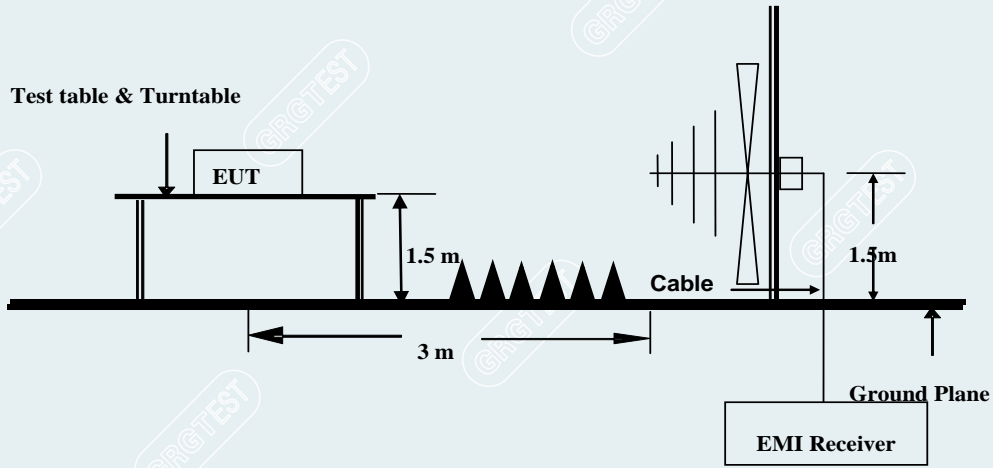

1000MHz~12750MHz

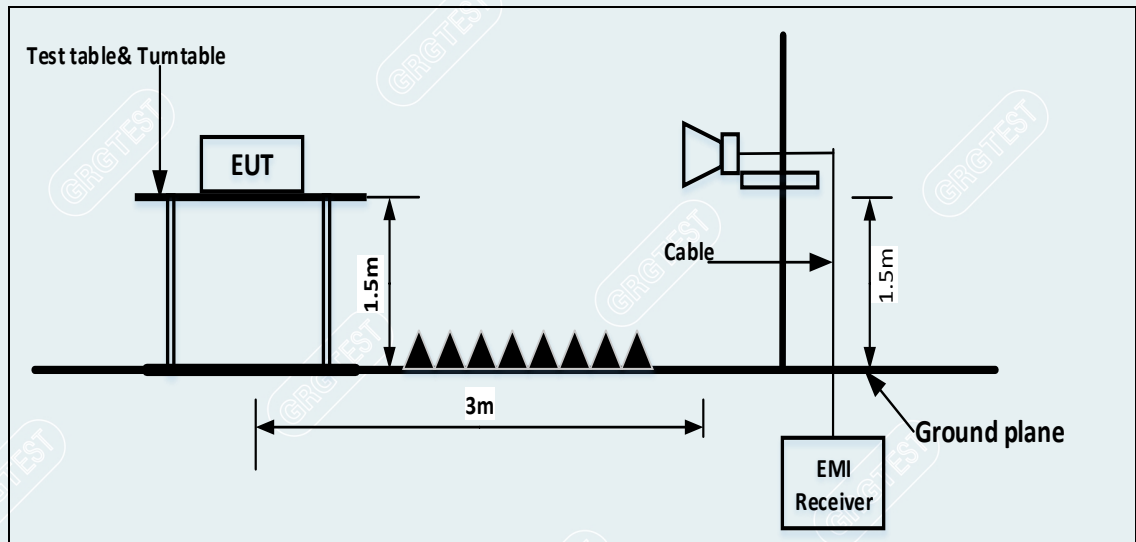

5.6.3 TEST PROCEDURES

Test condition: Normal test conditions.

Test channel: 2412MHz, 2472MHz for 802.11b/g/n HT20

Test procedure: Test procedure is according to Clause 5.4.9.2.1 of EN 300 328 V2.2.2

5.6.4 DATA SAMPLE

Freq. [MHz]	Reading [dBm]	Level [dBm]	Limit [dBm]	Margin [dB]	Factor [dB/m]	Detector	Polarity
XXX	-49.71	-57.90	-30.00	27.90	-8.19	RMS	Horizontal

Frequency (MHz) = Emission frequency in MHz

Reading (dBm) = Uncorrected Analyzer / Receiver reading

Correct Factor (dB/m) = Antenna factor + Cable loss – Amplifier gain

Result (dBm) = Reading (dBm) + Corr. Factor (dB/m)

Limit (dBm) = Limit stated in standard

Margin (dB) = Result (dBm) – Limit(dBm)

RMS = Root Mean Square

----- The following blanks -----

5.6.5 TEST RESULTS

This item pre-scan all power supply, AC 12V/24V supply by AC power convert, DC 8V/24V supply by DC adapter and DC 4.5V supply by battery, then the report display the worst case and data. (AC 24V supply by AC power convert)

Project No	E20220818423001	EUT:	Smart Video Doorbell G4
Model:	SVD-C01	Sample No:	E20220818423001-0001
Mode:	TX 802.11b 2412MHz	Voltage:	AC 24V by AC power convert from AC 230V/50Hz
Environment:	22.8°C/51%RH/101.0kPa	Engineer:	Zhang Qiang
Test Date:	2022-09-27	/	/

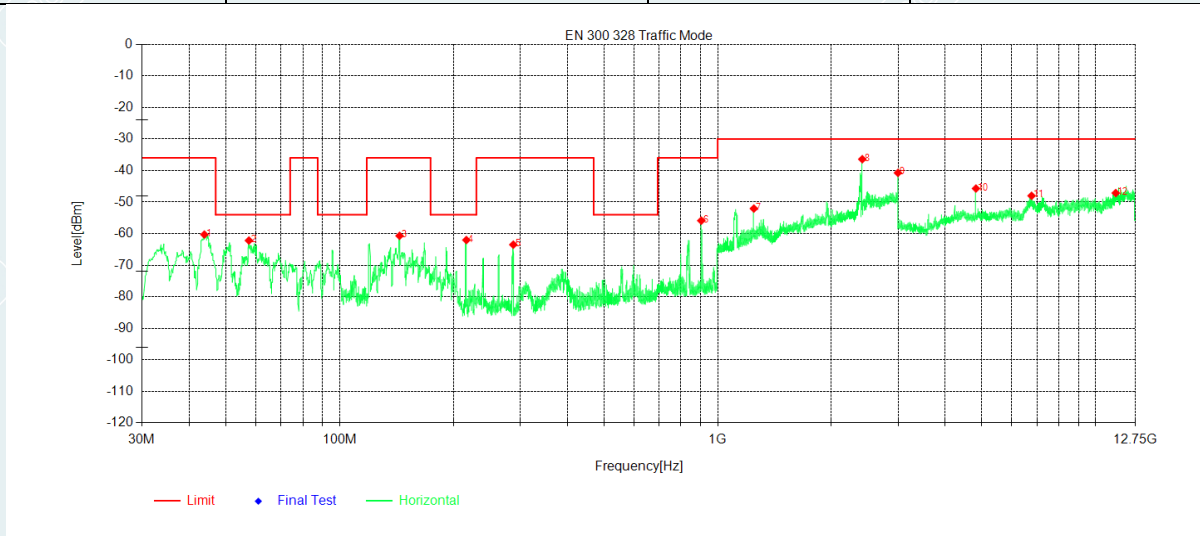

Suspected Data List

NO.	Freq. [MHz]	Reading [dBm]	Level [dBm]	Limit [dBm]	Margin [dB]	Factor [dB]	Detector	Polarity
1	43.871	-45.04	-60.28	-36.00	24.28	-15.24	RMS	Horizontal
2	57.548	-44.13	-62.17	-54.00	8.17	-18.04	RMS	Horizontal
3	144.072	-40.99	-60.67	-36.00	24.67	-19.68	RMS	Horizontal
4	216.434	-44.38	-62.02	-54.00	8.02	-17.64	RMS	Horizontal
5	288.02	-48.69	-63.49	-36.00	27.49	-14.80	RMS	Horizontal
6	905.134	-51.56	-55.86	-36.00	19.86	-4.30	RMS	Horizontal
7	1246.8	-53.14	-52.04	-30.00	22.04	1.10	RMS	Horizontal
8	2413.4	-46.57	-36.39	-30.00	6.39	10.18	RMS	Horizontal
9	2998.6	-53.86	-40.72	-30.00	10.72	13.14	RMS	Horizontal
10	4823.25	-43.98	-45.69	-30.00	15.69	-1.71	RMS	Horizontal
11	6767.4	-53.59	-47.99	-30.00	17.99	5.60	RMS	Horizontal
12	11301.15	-59.68	-47.12	-30.00	17.12	12.56	RMS	Horizontal

Project No	E20220818423001	EUT:	Smart Video Doorbell G4
Model:	SVD-C01	Sample No:	E20220818423001-0001
Mode:	TX 802.11b 2412MHz	Voltage:	AC 24V by AC power convert from AC 230V/50Hz
Environment:	22.8°C/51%RH/101.0kPa	Engineer:	Zhang Qiang
Test Date:	2022-09-27	/	/

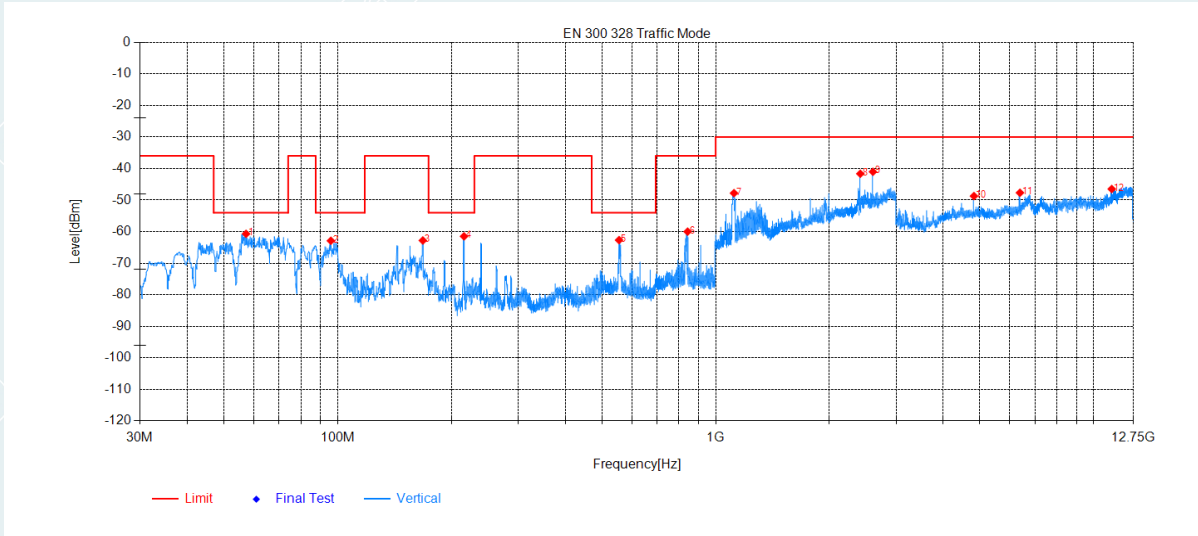

Suspected Data List								
NO.	Freq. [MHz]	Reading [dBm]	Level [dBm]	Limit [dBm]	Margin [dB]	Factor [dB]	Detector	Polarity
1	57.257	-47.76	-60.69	-54.00	6.69	-12.93	RMS	Vertical
2	95.96	-43.33	-62.87	-54.00	8.87	-19.54	RMS	Vertical
3	168.031	-44.56	-62.79	-36.00	26.79	-18.23	RMS	Vertical
4	215.949	-43.63	-61.48	-54.00	7.48	-17.85	RMS	Vertical
5	555.158	-52.28	-62.67	-54.00	8.67	-10.39	RMS	Vertical
6	842.957	-54.55	-59.98	-36.00	23.98	-5.43	RMS	Vertical
7	1118	-46.06	-47.79	-30.00	17.79	-1.73	RMS	Vertical
8	2413.4	-51.94	-41.63	-30.00	11.63	10.31	RMS	Vertical
9	2606.8	-51.51	-41.01	-30.00	11.01	10.50	RMS	Vertical
10	4823.25	-47.20	-48.71	-30.00	18.71	-1.51	RMS	Vertical
11	6381.3	-49.28	-47.66	-30.00	17.66	1.62	RMS	Vertical
12	11160.75	-58.79	-46.48	-30.00	16.48	12.31	RMS	Vertical

Project No	E20220818423001	EUT:	Smart Video Doorbell G4
Model:	SVD-C01	Sample No:	E20220818423001-0001
Mode:	TX 802.11b 2472MHz	Voltage:	AC 24V by AC power convert from AC 230V/50Hz
Environment:	22.8°C/51%RH/101.0kPa	Engineer:	Zhang Qiang
Test Date:	2022-09-27	/	/

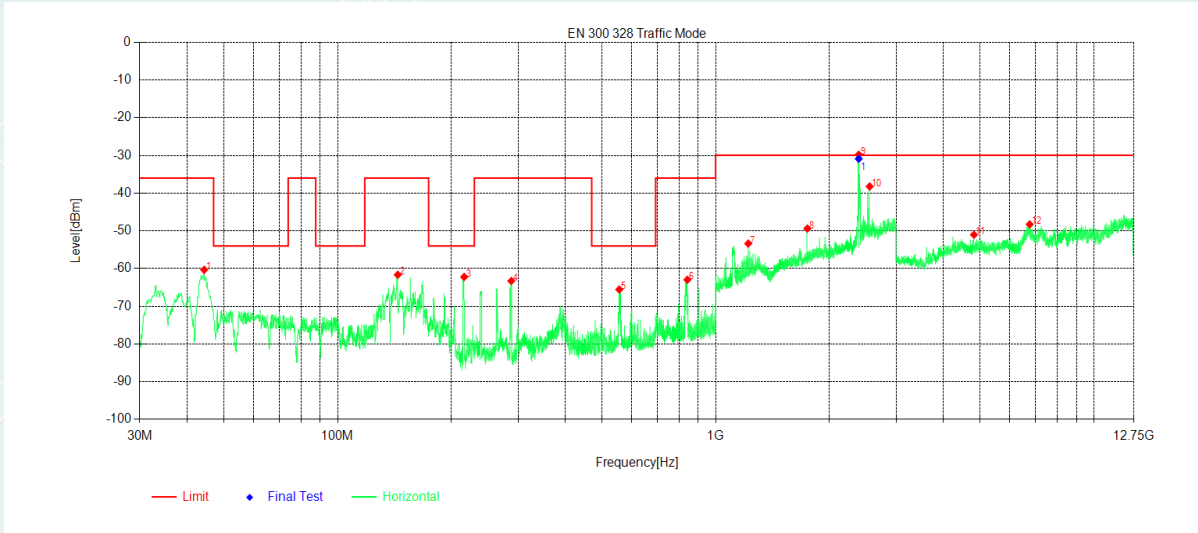

Suspected Data List								
NO.	Freq. [MHz]	Reading [dBm]	Level [dBm]	Limit [dBm]	Margin [dB]	Factor [dB]	Detector	Polarity
1	44.356	-44.95	-60.33	-36.00	24.33	-15.38	RMS	Horizontal
2	144.266	-41.93	-61.65	-36.00	25.65	-19.72	RMS	Horizontal
3	216.143	-44.57	-62.22	-54.00	8.22	-17.65	RMS	Horizontal
4	288.02	-48.50	-63.30	-36.00	27.30	-14.80	RMS	Horizontal
5	555.934	-55.47	-65.56	-54.00	11.56	-10.09	RMS	Horizontal
6	841.793	-57.22	-62.98	-36.00	26.98	-5.76	RMS	Horizontal
7	1219.6	-53.55	-53.38	-30.00	23.38	0.17	RMS	Horizontal
8	1748.2	-53.89	-49.40	-30.00	19.40	4.49	RMS	Horizontal
9	2390.4	-39.27	-29.80	-30.00	-0.20	9.47	RMS	Horizontal
10	2554.8	-49.07	-38.24	-30.00	8.24	10.83	RMS	Horizontal
11	4822.275	-49.32	-51.04	-30.00	21.04	-1.72	RMS	Horizontal
12	6770.325	-53.83	-48.29	-30.00	18.29	5.54	RMS	Horizontal

Final Data List								
NO.	Freq. [MHz]	Reading [dBm]	Level [dBm]	Limit [dBm]	Margin [dB]	Factor [dB]	Detector	Polarity
1	2390.4	-40.38	-30.91	-30.00	0.91	9.47	RMS	Horizontal

Project No	E20220818423001	EUT:	Smart Video Doorbell G4
Model:	SVD-C01	Sample No:	E20220818423001-0001
Mode:	TX 802.11b 2472MHz	Voltage:	AC 24V by AC power convert from AC 230V/50Hz
Environment:	22.8°C/51%RH/101.0kPa	Engineer:	Zhang Qiang
Test Date:	2022-09-27	/	/

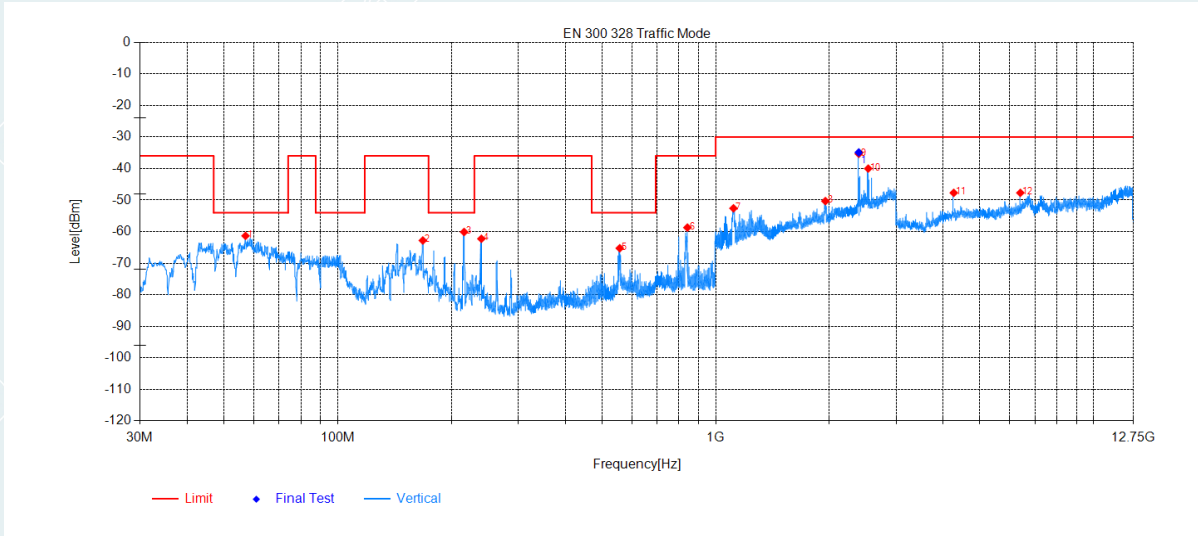

Suspected Data List								
NO.	Freq. [MHz]	Reading [dBm]	Level [dBm]	Limit [dBm]	Margin [dB]	Factor [dB]	Detector	Polarity
1	57.063	-48.38	-61.32	-54.00	7.32	-12.94	RMS	Vertical
2	168.031	-44.56	-62.79	-36.00	26.79	-18.23	RMS	Vertical
3	216.046	-42.25	-60.10	-54.00	6.10	-17.85	RMS	Vertical
4	240.005	-46.38	-62.25	-36.00	26.25	-15.87	RMS	Vertical
5	557.583	-54.80	-65.25	-54.00	11.25	-10.45	RMS	Vertical
6	841.89	-53.19	-58.70	-36.00	22.70	-5.51	RMS	Vertical
7	1114.8	-50.64	-52.59	-30.00	22.59	-1.95	RMS	Vertical
8	1950.8	-56.97	-50.31	-30.00	20.31	6.66	RMS	Vertical
9	2391.400	-44.99	-35.32	-30.00	5.32	9.67	RMS	Vertical
10	2532.6	-51.28	-40.00	-30.00	10.00	11.28	RMS	Vertical
11	4264.575	-45.59	-47.70	-30.00	17.70	-2.11	RMS	Vertical
12	6396.9	-49.37	-47.69	-30.00	17.69	1.68	RMS	Vertical

Final Data List								
NO.	Freq. [MHz]	Reading [dBm]	Level [dBm]	Limit [dBm]	Margin [dB]	Factor [dB]	Detector	Polarity
1	2391.400	-44.55	-34.88	-30.00	4.88	9.67	RMS	Vertical

Project No	E20220818423001	EUT:	Smart Video Doorbell G4
Model:	SVD-C01	Sample No:	E20220818423001-0001
Mode:	TX 802.11g 2412MHz	Voltage:	AC 24V by AC power convert from AC 230V/50Hz
Environment:	22.8°C/51%RH/101.0kPa	Engineer:	Zhang Qiang
Test Date:	2022-09-27	/	/

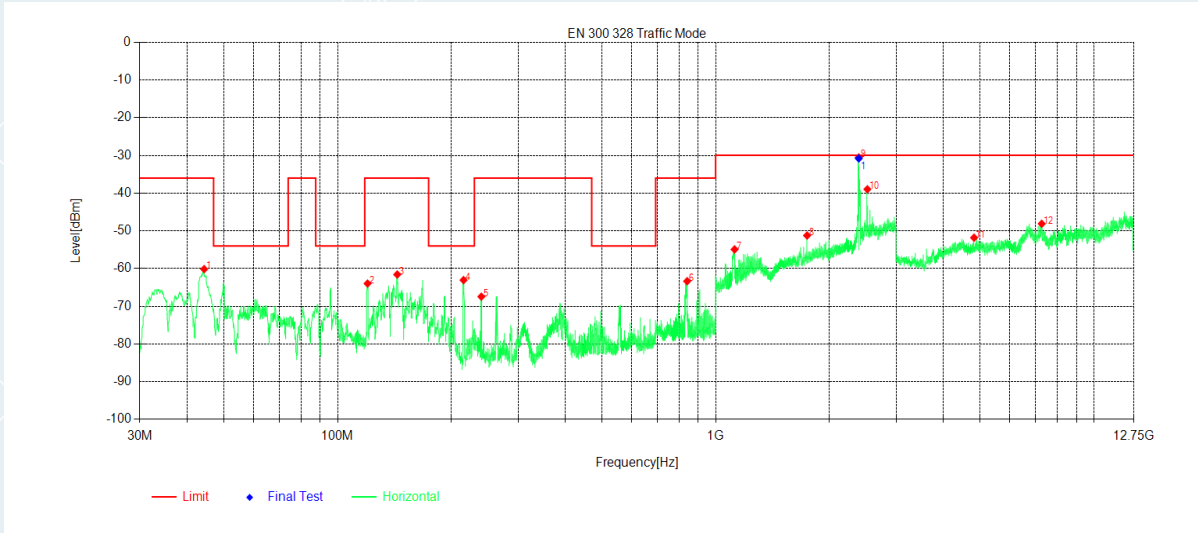

Suspected Data List

NO.	Freq. [MHz]	Reading [dBm]	Level [dBm]	Limit [dBm]	Margin [dB]	Factor [dB]	Detector	Polarity
1	44.356	-44.77	-60.15	-36.00	24.15	-15.38	RMS	Horizontal
2	120.016	-45.21	-63.98	-36.00	27.98	-18.77	RMS	Horizontal
3	143.781	-41.96	-61.59	-36.00	25.59	-19.63	RMS	Horizontal
4	215.367	-45.40	-63.07	-54.00	9.07	-17.67	RMS	Horizontal
5	240.005	-50.73	-67.45	-36.00	31.45	-16.72	RMS	Horizontal
6	840.532	-57.49	-63.36	-36.00	27.36	-5.87	RMS	Horizontal
7	1122.2	-52.99	-54.93	-30.00	24.93	-1.94	RMS	Horizontal
8	1745	-55.84	-51.24	-30.00	21.24	4.60	RMS	Horizontal
9	2390.6	-40.02	-30.55	-30.00	0.55	9.47	RMS	Horizontal
10	2519.4	-50.39	-38.97	-30.00	8.97	11.42	RMS	Horizontal
11	4825.2	-50.14	-51.82	-30.00	21.82	-1.68	RMS	Horizontal
12	7286.1	-54.12	-48.13	-30.00	18.13	5.99	RMS	Horizontal

Final Data List

NO.	Freq. [MHz]	Reading [dBm]	Level [dBm]	Limit [dBm]	Margin [dB]	Factor [dB]	Detector	Polarity
1	2390.6	-40.28	-30.81	-30.00	0.81	9.47	RMS	Horizontal

Project No	E20220818423001	EUT:	Smart Video Doorbell G4
Model:	SVD-C01	Sample No:	E20220818423001-0001
Mode:	TX 802.11g 2412MHz	Voltage:	AC 24V by AC power convert from AC 230V/50Hz
Environment:	22.8°C/51%RH/101.0kPa	Engineer:	Zhang Qiang
Test Date:	2022-09-27	/	/

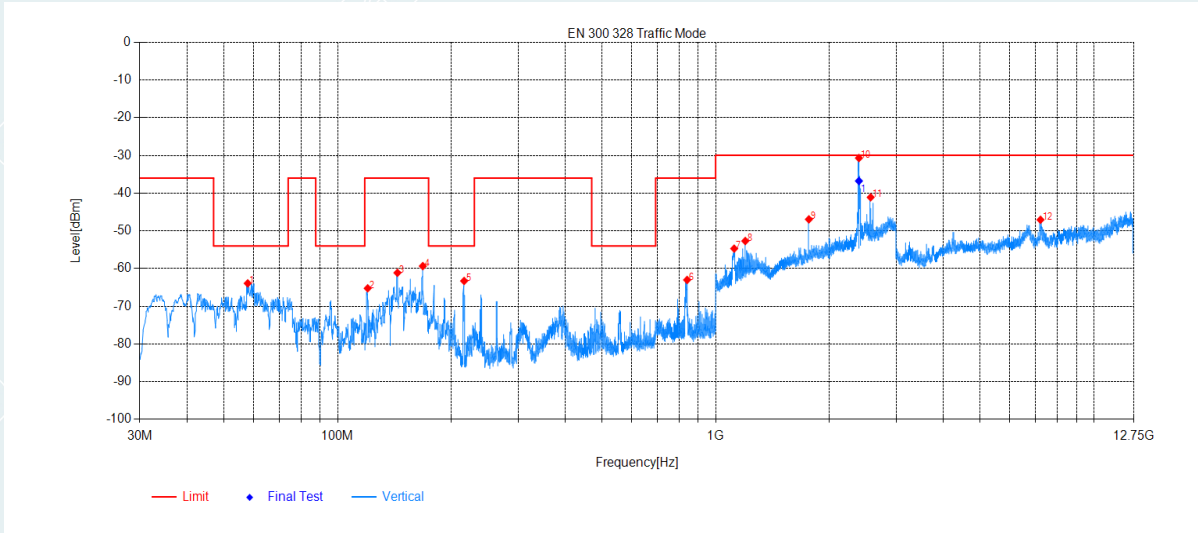

Suspected Data List								
NO.	Freq. [MHz]	Reading [dBm]	Level [dBm]	Limit [dBm]	Margin [dB]	Factor [dB]	Detector	Polarity
1	57.839	-51.05	-63.92	-54.00	9.92	-12.87	RMS	Vertical
2	120.113	-44.98	-65.24	-36.00	29.24	-20.26	RMS	Vertical
3	143.975	-41.51	-61.13	-36.00	25.13	-19.62	RMS	Vertical
4	168.031	-41.12	-59.35	-36.00	23.35	-18.23	RMS	Vertical
5	216.046	-45.44	-63.29	-54.00	9.29	-17.85	RMS	Vertical
6	840.241	-57.36	-63.02	-36.00	27.02	-5.66	RMS	Vertical
7	1119.4	-53.09	-54.72	-30.00	24.72	-1.63	RMS	Vertical
8	1197.6	-52.93	-52.70	-30.00	22.70	0.23	RMS	Vertical
9	1764.2	-52.36	-46.96	-30.00	16.96	5.40	RMS	Vertical
10	2393	-40.43	-30.71	-30.00	0.71	9.72	RMS	Vertical
11	2570.6	-51.08	-41.12	-30.00	11.12	9.96	RMS	Vertical
12	7232.475	-51.87	-47.07	-30.00	17.07	4.80	RMS	Vertical

Final Data List								
NO.	Freq. [MHz]	Reading [dBm]	Level [dBm]	Limit [dBm]	Margin [dB]	Factor [dB]	Detector	Polarity
1	2393	-46.51	-36.79	-30.00	6.79	9.72	RMS	Vertical

Project No	E20220818423001	EUT:	Smart Video Doorbell G4
Model:	SVD-C01	Sample No:	E20220818423001-0001
Mode:	TX 802.11g 2472MHz	Voltage:	AC 24V by AC power convert from AC 230V/50Hz
Environment:	22.8°C/51%RH/101.0kPa	Engineer:	Zhang Qiang
Test Date:	2022-09-27	/	/

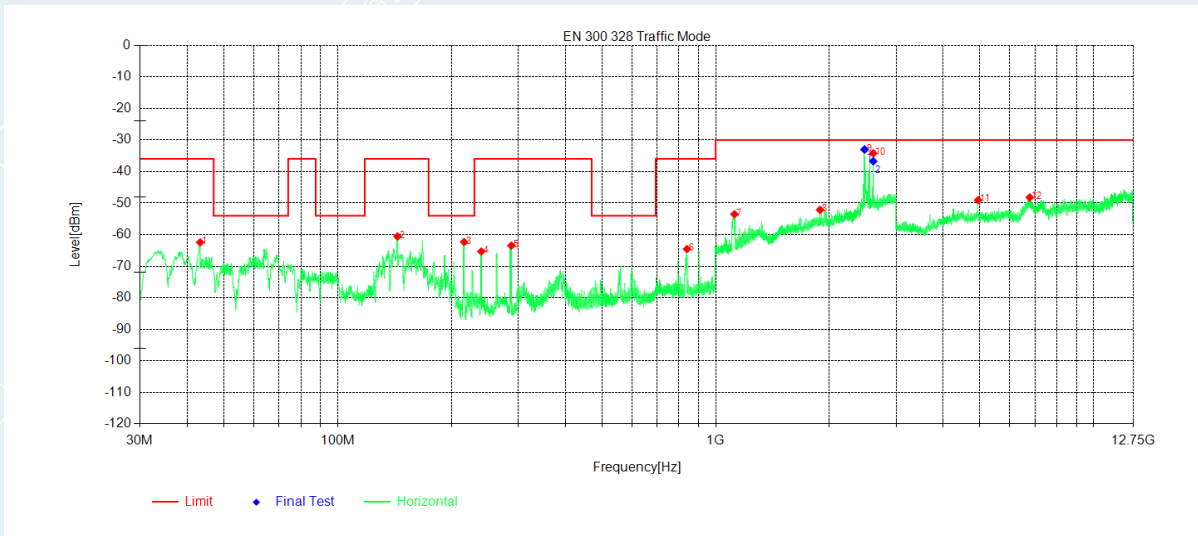

Suspected Data List								
NO.	Freq. [MHz]	Reading [dBm]	Level [dBm]	Limit [dBm]	Margin [dB]	Factor [dB]	Detector	Polarity
1	43.289	-47.38	-62.43	-36.00	26.43	-15.05	RMS	Horizontal
2	143.975	-40.89	-60.55	-36.00	24.55	-19.66	RMS	Horizontal
3	216.046	-44.66	-62.31	-54.00	8.31	-17.65	RMS	Horizontal
4	240.005	-48.62	-65.34	-36.00	29.34	-16.72	RMS	Horizontal
5	288.117	-48.67	-63.47	-36.00	27.47	-14.80	RMS	Horizontal
6	839.756	-58.64	-64.56	-36.00	28.56	-5.92	RMS	Horizontal
7	1121	-51.54	-53.52	-30.00	23.52	-1.98	RMS	Horizontal
8	1888.2	-58.54	-52.13	-30.00	22.13	6.41	RMS	Horizontal
9	2477.4	-45.02	-33.02	-30.00	3.02	12.00	RMS	Horizontal
10	2611.8	-46.12	-34.21	-30.00	4.21	11.91	RMS	Horizontal
11	4947.075	-48.12	-49.05	-30.00	19.05	-0.93	RMS	Horizontal
12	6775.2	-53.64	-48.20	-30.00	18.20	5.44	RMS	Horizontal

Final Data List								
NO.	Freq. [MHz]	Reading [dBm]	Level [dBm]	Limit [dBm]	Margin [dB]	Factor [dB]	Detector	Polarity
1	2477.4	-45.00	-33.00	-30.00	3.00	12.00	RMS	Horizontal
2	2611.8	-48.65	-36.74	-30.00	6.74	11.91	RMS	Horizontal

Project No	E20220818423001	EUT:	Smart Video Doorbell G4
Model:	SVD-C01	Sample No:	E20220818423001-0001
Mode:	TX 802.11g 2472MHz	Voltage:	AC 24V by AC power convert from AC 230V/50Hz
Environment:	22.8°C/51%RH/101.0kPa	Engineer:	Zhang Qiang
Test Date:	2022-09-27	/	/

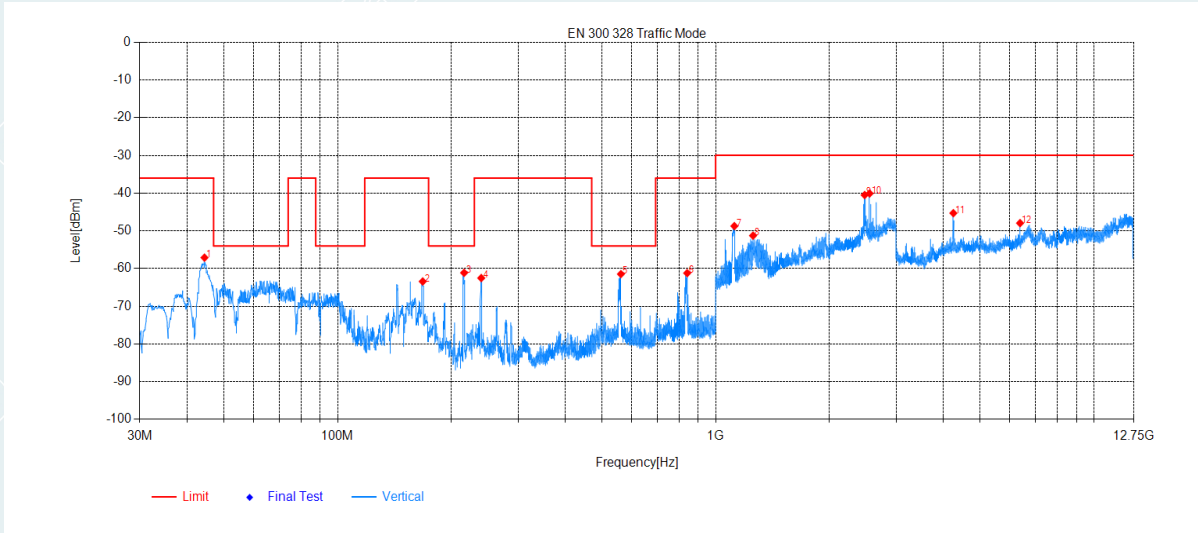

Suspected Data List

NO.	Freq. [MHz]	Reading [dBm]	Level [dBm]	Limit [dBm]	Margin [dB]	Factor [dB]	Detector	Polarity
1	44.453	-43.16	-57.11	-36.00	21.11	-13.95	RMS	Vertical
2	167.934	-45.20	-63.43	-36.00	27.43	-18.23	RMS	Vertical
3	216.046	-43.28	-61.13	-54.00	7.13	-17.85	RMS	Vertical
4	239.908	-46.64	-62.52	-36.00	26.52	-15.88	RMS	Vertical
5	561.56	-51.06	-61.47	-54.00	7.47	-10.41	RMS	Vertical
6	840.726	-55.60	-61.22	-36.00	25.22	-5.62	RMS	Vertical
7	1120.8	-47.19	-48.75	-30.00	18.75	-1.56	RMS	Vertical
8	1255.6	-52.62	-51.28	-30.00	21.28	1.34	RMS	Vertical
9	2478.2	-52.68	-40.51	-30.00	10.51	12.17	RMS	Vertical
10	2554.2	-50.39	-40.10	-30.00	10.10	10.29	RMS	Vertical
11	4253.85	-43.23	-45.32	-30.00	15.32	-2.09	RMS	Vertical
12	6384.225	-49.59	-47.96	-30.00	17.96	1.63	RMS	Vertical

Project No	E20220818423001	EUT:	Smart Video Doorbell G4
Model:	SVD-C01	Sample No:	E20220818423001-0001
Mode:	TX 802.11n HT20 2412MHz	Voltage:	AC 24V by AC power convert from AC 230V/50Hz
Environment:	22.8°C/51%RH/101.0kPa	Engineer:	Zhang Qiang
Test Date:	2022-09-27	/	/

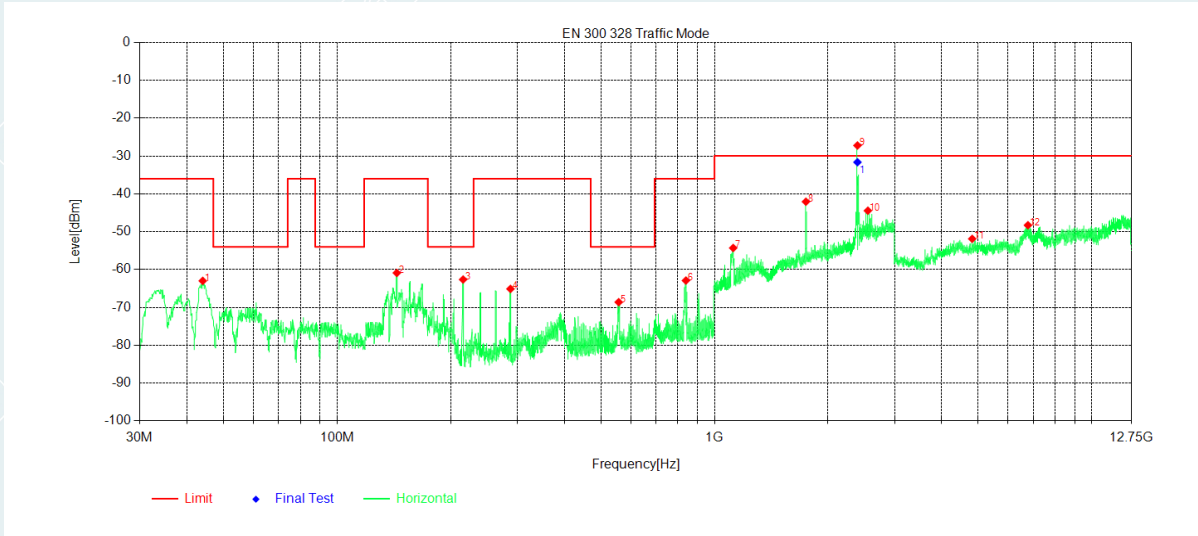

Suspected Data List								
NO.	Freq. [MHz]	Reading [dBm]	Level [dBm]	Limit [dBm]	Margin [dB]	Factor [dB]	Detector	Polarity
1	44.065	-47.70	-62.99	-36.00	26.99	-15.29	RMS	Horizontal
2	143.975	-41.23	-60.89	-36.00	24.89	-19.66	RMS	Horizontal
3	215.755	-44.97	-62.63	-54.00	8.63	-17.66	RMS	Horizontal
4	288.02	-50.32	-65.12	-36.00	29.12	-14.80	RMS	Horizontal
5	557.486	-58.51	-68.62	-54.00	14.62	-10.11	RMS	Horizontal
6	840.144	-57.00	-62.90	-36.00	26.90	-5.90	RMS	Horizontal
7	1121	-52.33	-54.31	-30.00	24.31	-1.98	RMS	Horizontal
8	1747	-46.61	-42.08	-30.00	12.08	4.53	RMS	Horizontal
9	2392.8	-36.79	-27.24	-30.00	-2.76	9.55	RMS	Horizontal
10	2549.6	-55.60	-44.45	-30.00	14.45	11.15	RMS	Horizontal
11	4818.375	-50.11	-51.89	-30.00	21.89	-1.78	RMS	Horizontal
12	6771.3	-53.82	-48.30	-30.00	18.30	5.52	RMS	Horizontal

Final Data List								
NO.	Freq. [MHz]	Reading [dBm]	Level [dBm]	Limit [dBm]	Margin [dB]	Factor [dB]	Detector	Polarity
1	2392.8	-41.21	-31.66	-30.00	1.66	9.55	RMS	Horizontal

Project No	E20220818423001	EUT:	Smart Video Doorbell G4
Model:	SVD-C01	Sample No:	E20220818423001-0001
Mode:	TX 802.11n HT20 2412MHz	Voltage:	AC 24V by AC power convert from AC 230V/50Hz
Environment:	22.8°C/51%RH/101.0kPa	Engineer:	Zhang Qiang
Test Date:	2022-09-27	/	/

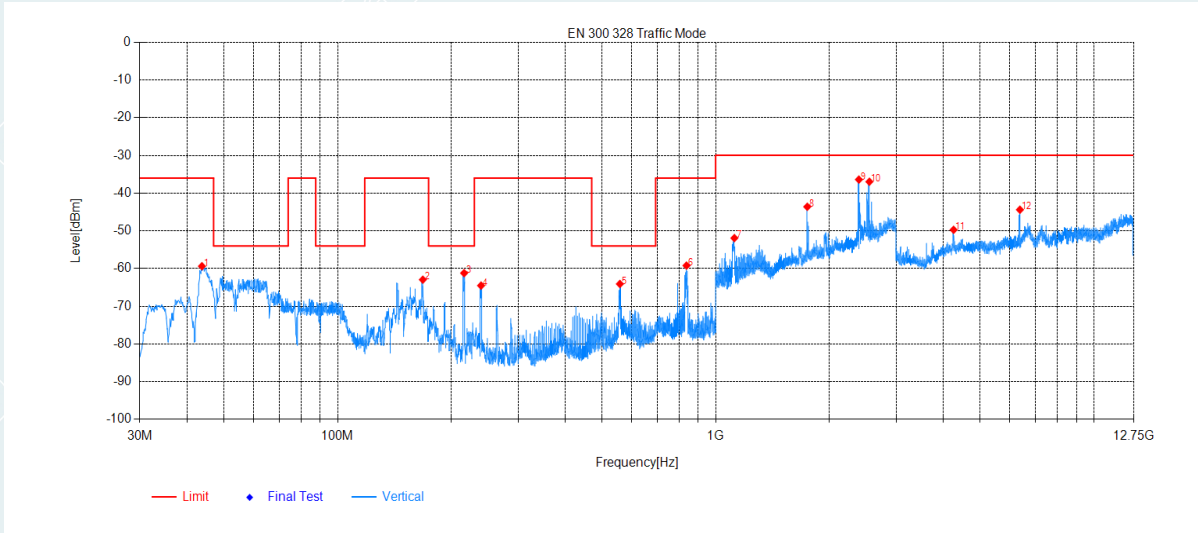

Suspected Data List

NO.	Freq. [MHz]	Reading [dBm]	Level [dBm]	Limit [dBm]	Margin [dB]	Factor [dB]	Detector	Polarity
1	43.774	-45.38	-59.38	-36.00	23.38	-14.00	RMS	Vertical
2	168.031	-44.72	-62.95	-36.00	26.95	-18.23	RMS	Vertical
3	216.046	-43.36	-61.21	-54.00	7.21	-17.85	RMS	Vertical
4	239.617	-48.61	-64.52	-36.00	28.52	-15.91	RMS	Vertical
5	557.971	-53.62	-64.08	-54.00	10.08	-10.46	RMS	Vertical
6	837.234	-53.45	-59.22	-36.00	23.22	-5.77	RMS	Vertical
7	1120.8	-50.36	-51.92	-30.00	21.92	-1.56	RMS	Vertical
8	1747.2	-48.43	-43.62	-30.00	13.62	4.81	RMS	Vertical
9	2393	-46.14	-36.42	-30.00	6.42	9.72	RMS	Vertical
10	2550.6	-47.57	-36.98	-30.00	6.98	10.59	RMS	Vertical
11	4259.7	-47.63	-49.73	-30.00	19.73	-2.10	RMS	Vertical
12	6379.35	-46.01	-44.40	-30.00	14.40	1.61	RMS	Vertical

Project No	E20220818423001	EUT:	Smart Video Doorbell G4
Model:	SVD-C01	Sample No:	E20220818423001-0001
Mode:	TX 802.11n HT20 2472MHz	Voltage:	AC 24V by AC power convert from AC 230V/50Hz
Environment:	22.8°C/51%RH/101.0kPa	Engineer:	Zhang Qiang
Test Date:	2022-09-27	/	/

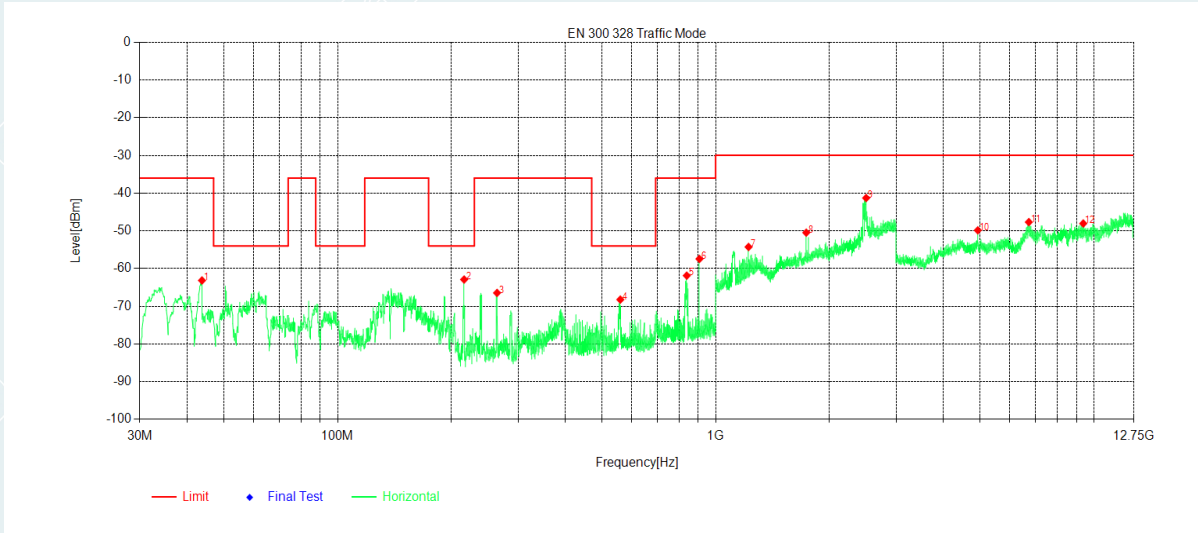

Suspected Data List								
NO.	Freq. [MHz]	Reading [dBm]	Level [dBm]	Limit [dBm]	Margin [dB]	Factor [dB]	Detector	Polarity
1	43.774	-47.95	-63.16	-36.00	27.16	-15.21	RMS	Horizontal
2	216.046	-45.26	-62.91	-54.00	8.91	-17.65	RMS	Horizontal
3	264.061	-51.19	-66.46	-36.00	30.46	-15.27	RMS	Horizontal
4	559.523	-58.10	-68.23	-54.00	14.23	-10.13	RMS	Horizontal
5	838.495	-55.91	-61.88	-36.00	25.88	-5.97	RMS	Horizontal
6	905.813	-53.12	-57.45	-36.00	21.45	-4.33	RMS	Horizontal
7	1221.8	-54.45	-54.28	-30.00	24.28	0.17	RMS	Horizontal
8	1736.4	-55.48	-50.48	-30.00	20.48	5.00	RMS	Horizontal
9	2501.4	-52.49	-41.30	-30.00	11.30	11.19	RMS	Horizontal
10	4936.35	-49.02	-49.86	-30.00	19.86	-0.84	RMS	Horizontal
11	6738.15	-53.53	-47.69	-30.00	17.69	5.84	RMS	Horizontal
12	9385.275	-56.96	-48.05	-30.00	18.05	8.91	RMS	Horizontal

Project No	E20220818423001	EUT:	Smart Video Doorbell G4
Model:	SVD-C01	Sample No:	E20220818423001-0001
Mode:	TX 802.11n HT20 2472MHz	Voltage:	AC 24V by AC power convert from AC 230V/50Hz
Environment:	22.8°C/51%RH/101.0kPa	Engineer:	Zhang Qiang
Test Date:	2022-09-27	/	/

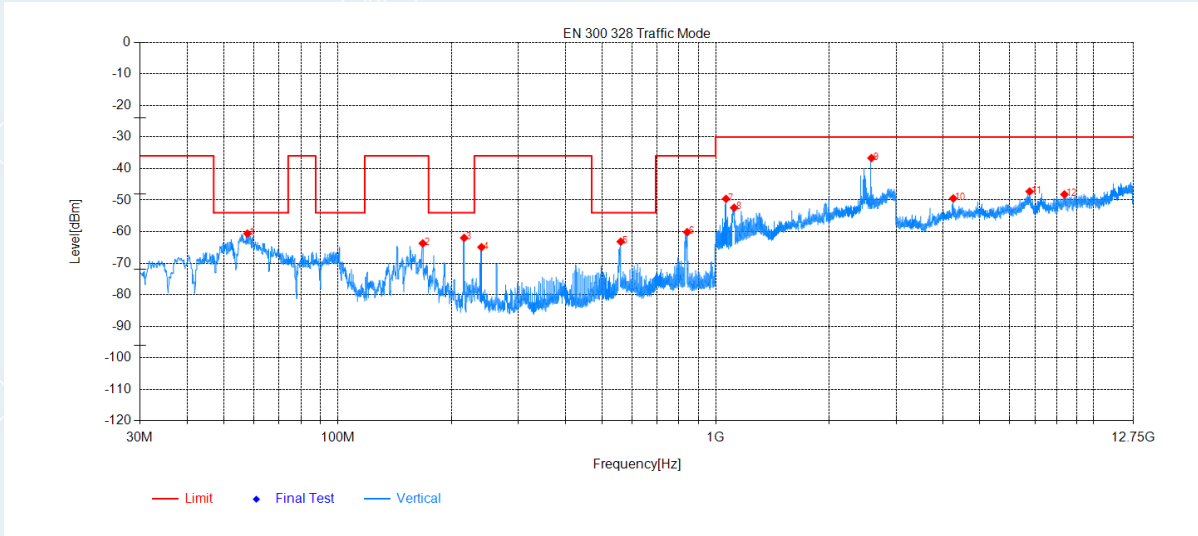

Suspected Data List								
NO.	Freq. [MHz]	Reading [dBm]	Level [dBm]	Limit [dBm]	Margin [dB]	Factor [dB]	Detector	Polarity
1	57.742	-47.73	-60.61	-54.00	6.61	-12.88	RMS	Vertical
2	168.031	-45.48	-63.71	-36.00	27.71	-18.23	RMS	Vertical
3	216.143	-44.12	-61.97	-54.00	7.97	-17.85	RMS	Vertical
4	240.199	-49.02	-64.91	-36.00	28.91	-15.89	RMS	Vertical
5	561.075	-52.72	-63.16	-54.00	9.16	-10.44	RMS	Vertical
6	840.726	-54.54	-60.16	-36.00	24.16	-5.62	RMS	Vertical
7	1065	-46.91	-49.59	-30.00	19.59	-2.68	RMS	Vertical
8	1119	-50.76	-52.42	-30.00	22.42	-1.66	RMS	Vertical
9	2583.2	-46.59	-36.68	-30.00	6.68	9.91	RMS	Vertical
10	4251.9	-47.37	-49.46	-30.00	19.46	-2.09	RMS	Vertical
11	6769.35	-53.18	-47.26	-30.00	17.26	5.92	RMS	Vertical
12	8365.425	-55.36	-48.18	-30.00	18.18	7.18	RMS	Vertical

5.7 RECEIVER SPURIOUS EMISSIONS

Test Requirement: EN300 328 V2.2.2/ 4.3.2.10

Test Method: EN300 328 V2.2.2/5.4.10.2.2

5.7.1 LIMIT

The spurious emissions of the receiver shall not exceed the values given in table 3.

In case of equipment with antenna connectors, these limits apply to emissions at the antenna port (conducted). For emissions radiated by the cabinet or for emissions radiated by integral antenna equipment (without antenna connectors), these limits are e.r.p. for emissions up to 1 GHz and e.i.r.p. for emissions above 1 GHz.

This device uses Radiated measurement.

Table 3: Spurious emission limits for receivers

Frequency range	Maximum power	Bandwidth
30 MHz to 1 GHz	-57 dBm	100 kHz
1 GHz to 12,75 GHz	-47 dBm	1 MHz

----- The following blanks -----

TEST CONFIGURATION

30MHz-1000MHz

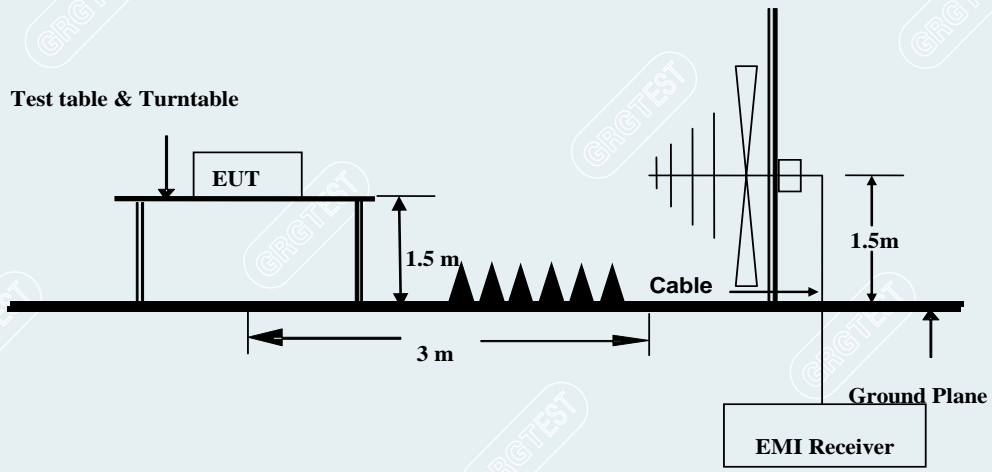

1000MHz-12750MHz

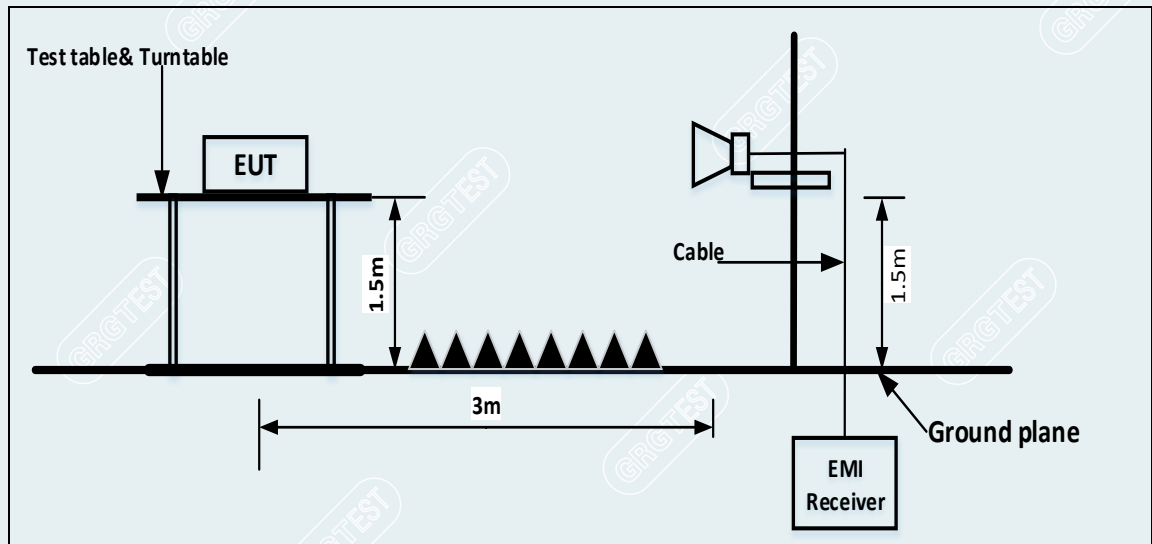

5.7.2 TEST PROCEDURES

Test channel: 2412MHz, 2472MHz for 802.11b/g/n HT20

Test condition: Normal test conditions.

Test procedure: Test procedure is according to Clause 5.4.10.2.2 of EN 300 328 V2.2.2

Remark: /

5.7.3 DATA SAMPLE

Freq. [MHz]	Reading [dBm]	Level [dBm]	Limit [dBm]	Margin [dB]	Factor [dB/m]	Detector	Polarity
XXX	-58.02	-73.33	-57.00	16.33	-15.31	RMS	Horizontal

Frequency (MHz) = Emission frequency in MHz

Reading (dBm) = Uncorrected Analyzer / Receiver reading

Correct Factor (dB/m) = Antenna factor + Cable loss – Amplifier gain

Result (dBm) = Reading (dBm) + Corr. Factor (dB/m)

Limit (dBm) = Limit stated in standard

Margin (dB) = Result (dBm) – Limit(dBm)

RMS = Root Mean Square

----- The following blanks -----

5.7.4 TEST RESULTS

This item pre-scan all power supply, AC 12V/24V supply by AC power convert, DC 8V/24V supply by DC adapter and DC 4.5V supply by battery, then the report display the worst case and data. (AC 24V supply by AC power convert)

Project No	E20220818423001	EUT:	Smart Video Doorbell G4
Model:	SVD-C01	Sample No:	E20220818423001-0001
Mode:	RX 802.11b 2412MHz	Voltage:	AC 24V by AC power convert from AC 230V/50Hz
Environment:	23.8°C/55%RH/101.0kPa	Engineer:	Zhang Zishan
Test Date:	2022-09-30	/	/

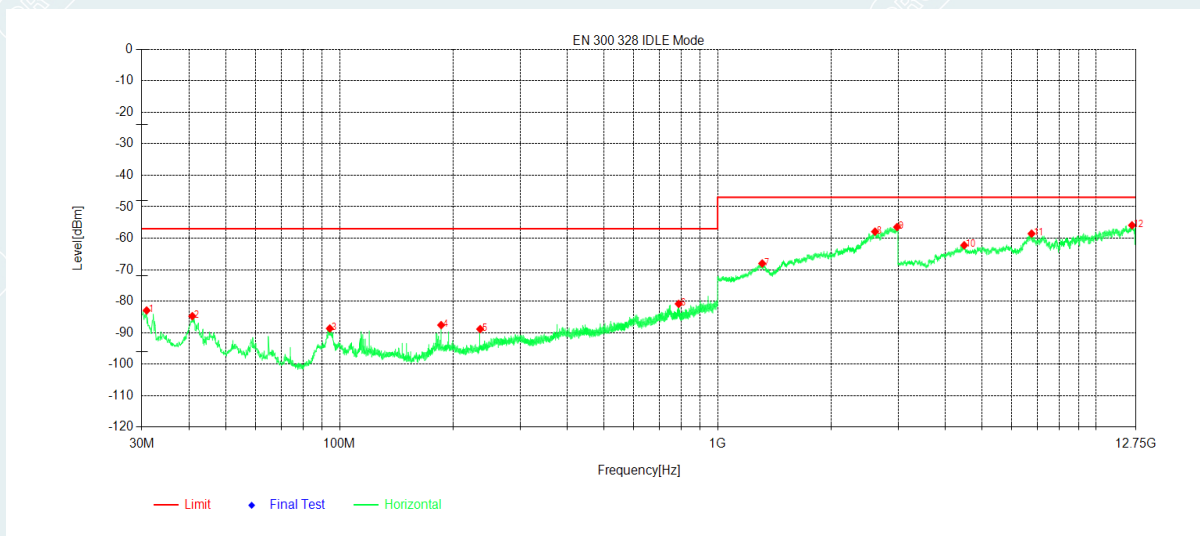

Suspected Data List								
NO.	Freq. [MHz]	Reading [dBm]	Level [dBm]	Limit [dBm]	Margin [dB]	Factor [dB]	Detector	Polarity
1	30.873	-68.02	-82.92	-57.00	25.92	-14.90	RMS	Horizontal
2	40.767	-70.67	-84.74	-57.00	27.74	-14.07	RMS	Horizontal
3	94.214	-71.77	-88.65	-57.00	31.65	-16.88	RMS	Horizontal
4	185.588	-69.99	-87.58	-57.00	30.58	-17.59	RMS	Horizontal
5	235.446	-72.19	-88.85	-57.00	31.85	-16.66	RMS	Horizontal
6	788.637	-76.63	-80.83	-57.00	23.83	-4.20	RMS	Horizontal
7	1311.8	-71.23	-68.01	-47.00	21.01	3.22	RMS	Horizontal
8	2608	-70.00	-57.90	-47.00	10.90	12.10	RMS	Horizontal
9	2982	-70.06	-56.45	-47.00	9.45	13.61	RMS	Horizontal
10	4489.8	-60.64	-62.23	-47.00	15.23	-1.59	RMS	Horizontal
11	6765.45	-63.81	-58.54	-47.00	11.54	5.27	RMS	Horizontal
12	12476.02	-69.86	-55.89	-47.00	8.89	13.97	RMS	Horizontal

Project No	E20220818423001	EUT:	Smart Video Doorbell G4
Model:	SVD-C01	Sample No:	E20220818423001-0001
Mode:	RX 802.11b 2412MHz	Voltage:	AC 24V by AC power convert from AC 230V/50Hz
Environment:	23.8°C/55%RH/101.0kPa	Engineer:	Zhang Zishan
Test Date:	2022-09-30	/	/

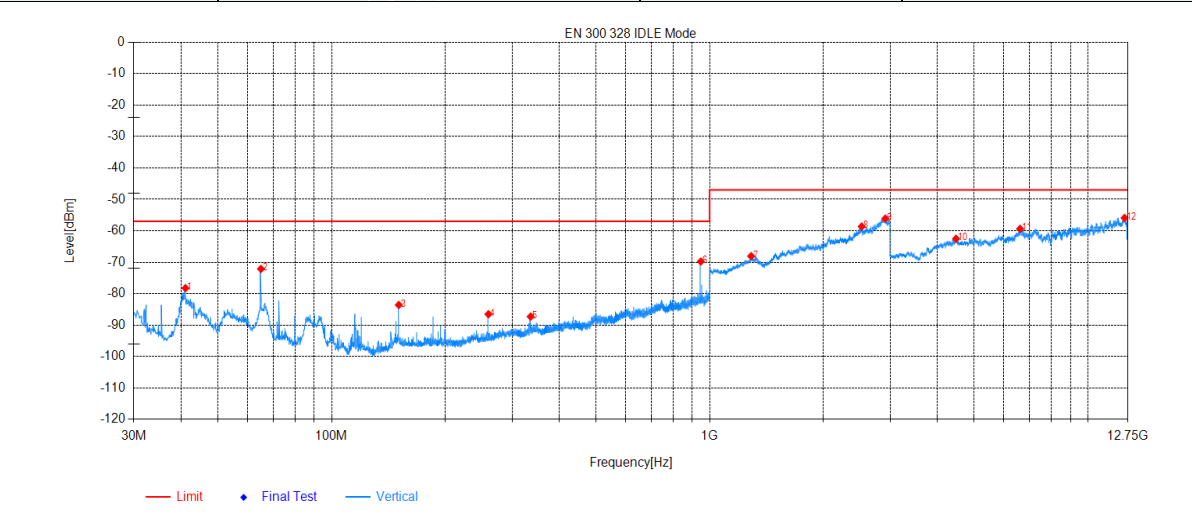

Suspected Data List

NO.	Freq. [MHz]	Reading [dBm]	Level [dBm]	Limit [dBm]	Margin [dB]	Factor [dB]	Detector	Polarity
1	41.058	-64.29	-78.24	-57.00	21.24	-13.95	RMS	Vertical
2	65.017	-56.89	-72.11	-57.00	15.11	-15.22	RMS	Vertical
3	150.571	-64.89	-83.58	-57.00	26.58	-18.69	RMS	Vertical
4	259.89	-70.14	-86.53	-57.00	29.53	-16.39	RMS	Vertical
5	336.035	-73.76	-87.27	-57.00	30.27	-13.51	RMS	Vertical
6	947.62	-66.89	-69.78	-57.00	12.78	-2.89	RMS	Vertical
7	1287.4	-70.96	-68.04	-47.00	21.04	2.92	RMS	Vertical
8	2524.4	-70.12	-58.63	-47.00	11.63	11.49	RMS	Vertical
9	2914.4	-70.44	-56.11	-47.00	9.11	14.33	RMS	Vertical
10	4484.925	-60.76	-62.52	-47.00	15.52	-1.76	RMS	Vertical
11	6624.075	-63.79	-59.37	-47.00	12.37	4.42	RMS	Vertical
12	12515.02	-70.19	-55.89	-47.00	8.89	14.30	RMS	Vertical

Project No	E20220818423001	EUT:	Smart Video Doorbell G4
Model:	SVD-C01	Sample No:	E20220818423001-0001
Mode:	RX 802.11b 2472MHz	Voltage:	AC 24V by AC power convert from AC 230V/50Hz
Environment:	23.8°C/55%RH/101.0kPa	Engineer:	Zhang Zishan
Test Date:	2022-09-30	/	/

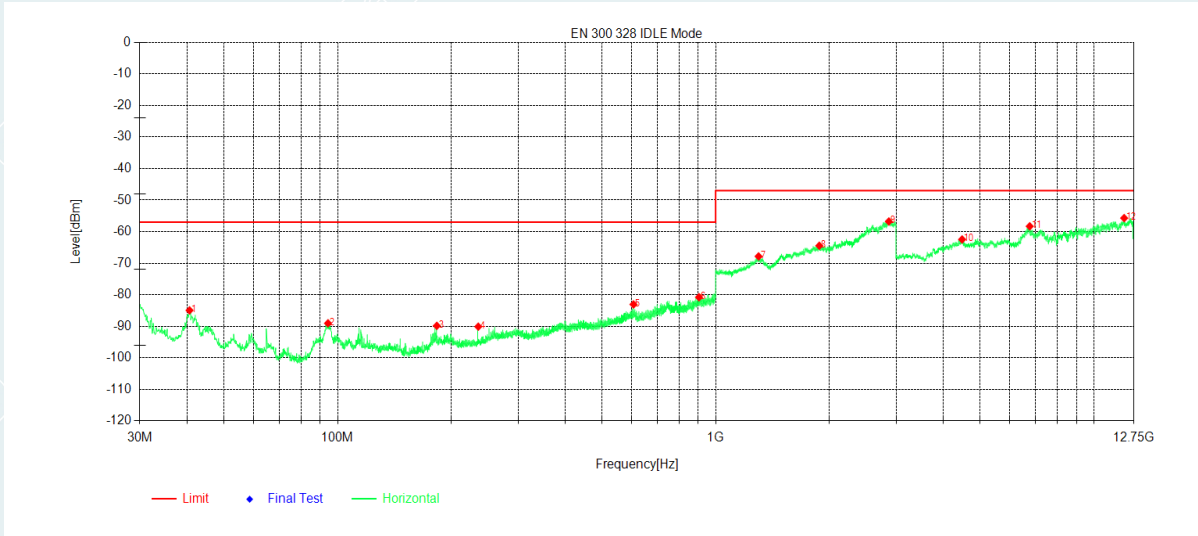

Suspected Data List								
NO.	Freq. [MHz]	Reading [dBm]	Level [dBm]	Limit [dBm]	Margin [dB]	Factor [dB]	Detector	Polarity
1	40.573	-70.92	-84.94	-57.00	27.94	-14.02	RMS	Horizontal
2	94.311	-72.16	-89.04	-57.00	32.04	-16.88	RMS	Horizontal
3	182.969	-71.81	-89.83	-57.00	32.83	-18.02	RMS	Horizontal
4	235.543	-73.45	-90.10	-57.00	33.10	-16.65	RMS	Horizontal
5	606.18	-75.98	-83.05	-57.00	26.05	-7.07	RMS	Horizontal
6	903.582	-77.92	-80.78	-57.00	23.78	-2.86	RMS	Horizontal
7	1298.8	-70.95	-67.84	-47.00	20.84	3.11	RMS	Horizontal
8	1879.8	-71.59	-64.45	-47.00	17.45	7.14	RMS	Horizontal
9	2871.8	-69.94	-56.78	-47.00	9.78	13.16	RMS	Horizontal
10	4485.9	-60.84	-62.46	-47.00	15.46	-1.62	RMS	Horizontal
11	6772.275	-63.42	-58.30	-47.00	11.30	5.12	RMS	Horizontal
12	12039.22	-68.59	-55.70	-47.00	8.70	12.89	RMS	Horizontal

Project No	E20220818423001	EUT:	Smart Video Doorbell G4
Model:	SVD-C01	Sample No:	E20220818423001-0001
Mode:	RX 802.11b 2472MHz	Voltage:	AC 24V by AC power convert from AC 230V/50Hz
Environment:	23.8°C/55%RH/101.0kPa	Engineer:	Zhang Zishan
Test Date:	2022-09-30	/	/

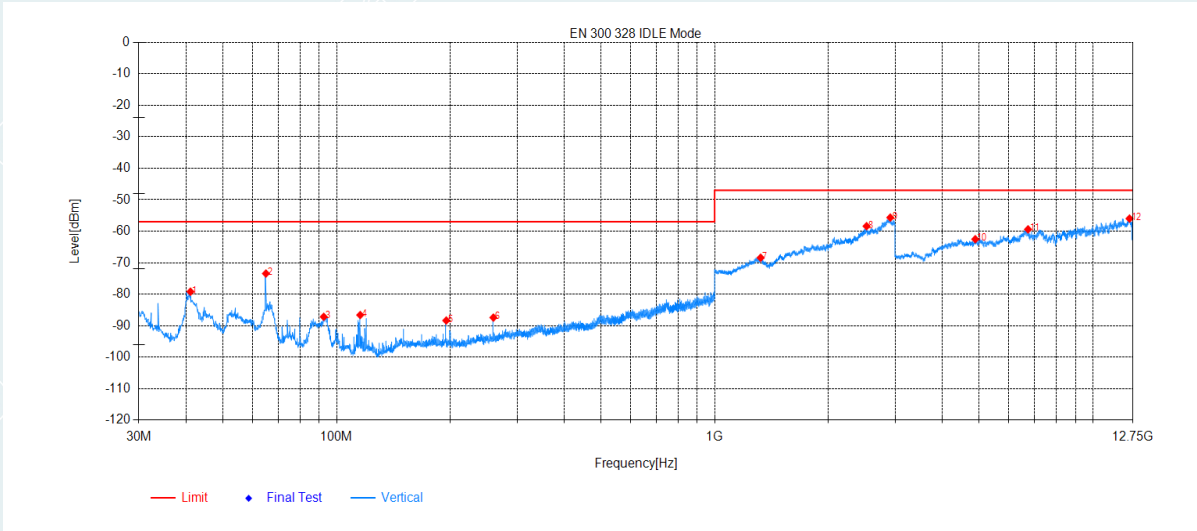

Suspected Data List								
NO.	Freq. [MHz]	Reading [dBm]	Level [dBm]	Limit [dBm]	Margin [dB]	Factor [dB]	Detector	Polarity
1	41.058	-65.24	-79.19	-57.00	22.19	-13.95	RMS	Vertical
2	65.017	-58.21	-73.43	-57.00	16.43	-15.22	RMS	Vertical
3	92.468	-67.69	-87.17	-57.00	30.17	-19.48	RMS	Vertical
4	115.457	-66.60	-86.59	-57.00	29.59	-19.99	RMS	Vertical
5	194.997	-70.84	-88.34	-57.00	31.34	-17.50	RMS	Vertical
6	259.89	-71.03	-87.42	-57.00	30.42	-16.39	RMS	Vertical
7	1323	-71.71	-68.41	-47.00	21.41	3.30	RMS	Vertical
8	2522.6	-69.89	-58.39	-47.00	11.39	11.50	RMS	Vertical
9	2915	-70.01	-55.66	-47.00	8.66	14.35	RMS	Vertical
10	4890.525	-61.57	-62.53	-47.00	15.53	-0.96	RMS	Vertical
11	6744.975	-65.23	-59.39	-47.00	12.39	5.84	RMS	Vertical
12	12513.07	-70.31	-55.97	-47.00	8.97	14.34	RMS	Vertical

Project No	E20220818423001	EUT:	Smart Video Doorbell G4
Model:	SVD-C01	Sample No:	E20220818423001-0001
Mode:	RX 802.11g 2412MHz	Voltage:	AC 24V by AC power convert from AC 230V/50Hz
Environment:	23.8°C/55%RH/101.0kPa	Engineer:	Zhang Zishan
Test Date:	2022-09-30	/	/

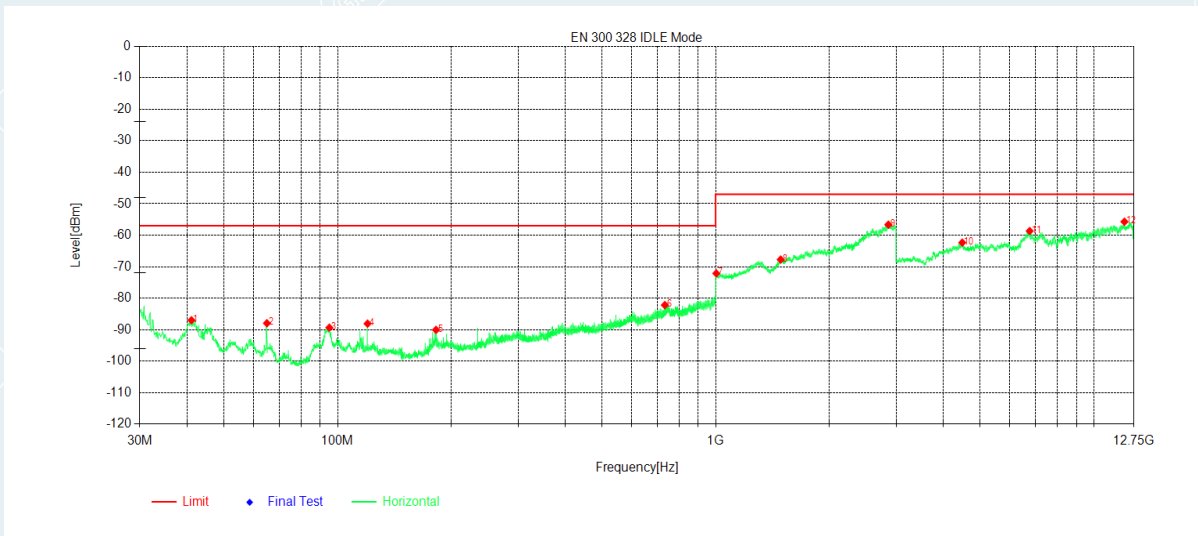

Suspected Data List								
NO.	Freq. [MHz]	Reading [dBm]	Level [dBm]	Limit [dBm]	Margin [dB]	Factor [dB]	Detector	Polarity
1	41.058	-72.84	-87.00	-57.00	30.00	-14.16	RMS	Horizontal
2	65.017	-68.30	-87.94	-57.00	30.94	-19.64	RMS	Horizontal
3	95.087	-72.46	-89.33	-57.00	32.33	-16.87	RMS	Horizontal
4	120.016	-69.55	-88.07	-57.00	31.07	-18.52	RMS	Horizontal
5	182.096	-71.88	-90.05	-57.00	33.05	-18.17	RMS	Horizontal
6	733.735	-76.48	-82.18	-57.00	25.18	-5.70	RMS	Horizontal
7	1004	-71.11	-72.12	-47.00	25.12	-1.01	RMS	Horizontal
8	1486.2	-71.48	-67.73	-47.00	20.73	3.75	RMS	Horizontal
9	2863.2	-69.79	-56.65	-47.00	9.65	13.14	RMS	Horizontal
10	4490.775	-60.74	-62.33	-47.00	15.33	-1.59	RMS	Horizontal
11	6771.3	-63.79	-58.65	-47.00	11.65	5.14	RMS	Horizontal
12	12056.77	-68.57	-55.70	-47.00	8.70	12.87	RMS	Horizontal

Project No	E20220818423001	EUT:	Smart Video Doorbell G4
Model:	SVD-C01	Sample No:	E20220818423001-0001
Mode:	RX 802.11g 2412MHz	Voltage:	AC 24V by AC power convert from AC 230V/50Hz
Environment:	23.8°C/55%RH/101.0kPa	Engineer:	Zhang Zishan
Test Date:	2022-09-30	/	/

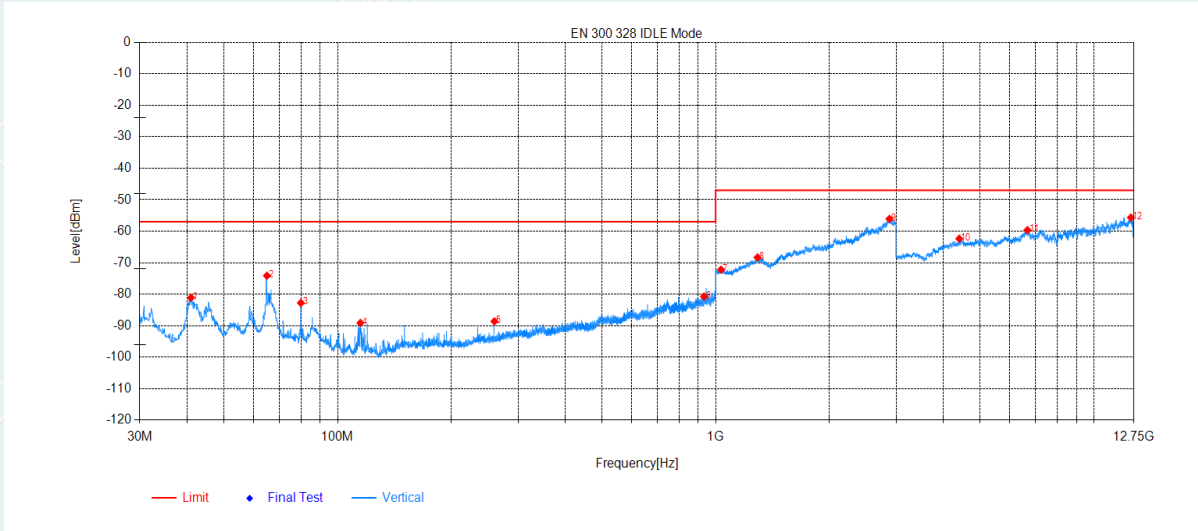

Suspected Data List								
NO.	Freq. [MHz]	Reading [dBm]	Level [dBm]	Limit [dBm]	Margin [dB]	Factor [dB]	Detector	Polarity
1	40.961	-67.14	-81.10	-57.00	24.10	-13.96	RMS	Vertical
2	65.017	-58.89	-74.11	-57.00	17.11	-15.22	RMS	Vertical
3	79.955	-61.07	-82.75	-57.00	25.75	-21.68	RMS	Vertical
4	114.875	-69.12	-89.11	-57.00	32.11	-19.99	RMS	Vertical
5	259.89	-72.23	-88.62	-57.00	31.62	-16.39	RMS	Vertical
6	931.227	-77.92	-80.73	-57.00	23.73	-2.81	RMS	Vertical
7	1033.2	-71.10	-72.21	-47.00	25.21	-1.11	RMS	Vertical
8	1290	-71.46	-68.33	-47.00	21.33	3.13	RMS	Vertical
9	2882.2	-69.85	-56.09	-47.00	9.09	13.76	RMS	Vertical
10	4408.875	-60.37	-62.37	-47.00	15.37	-2.00	RMS	Vertical
11	6678.675	-64.61	-59.64	-47.00	12.64	4.97	RMS	Vertical
12	12540.37	-69.43	-55.66	-47.00	8.66	13.77	RMS	Vertical

Project No	E20220818423001	EUT:	Smart Video Doorbell G4
Model:	SVD-C01	Sample No:	E20220818423001-0001
Mode:	RX 802.11g 2472MHz	Voltage:	AC 24V by AC power convert from AC 230V/50Hz
Environment:	23.8°C/55%RH/101.0kPa	Engineer:	Zhang Zishan
Test Date:	2022-09-30	/	/

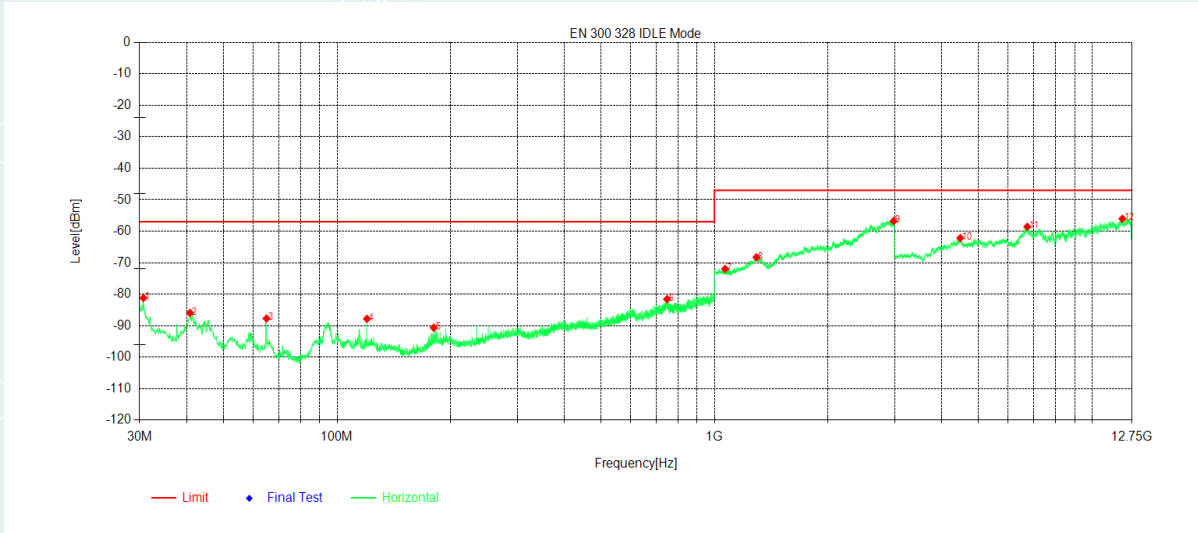

Suspected Data List								
NO.	Freq. [MHz]	Reading [dBm]	Level [dBm]	Limit [dBm]	Margin [dB]	Factor [dB]	Detector	Polarity
1	30.679	-66.25	-81.17	-57.00	24.17	-14.92	RMS	Horizontal
2	40.767	-71.84	-85.91	-57.00	28.91	-14.07	RMS	Horizontal
3	65.017	-68.05	-87.69	-57.00	30.69	-19.64	RMS	Horizontal
4	120.016	-69.30	-87.82	-57.00	30.82	-18.52	RMS	Horizontal
5	180.447	-72.18	-90.62	-57.00	33.62	-18.44	RMS	Horizontal
6	748.77	-77.88	-81.55	-57.00	24.55	-3.67	RMS	Horizontal
7	1066.6	-70.05	-71.95	-47.00	24.95	-1.90	RMS	Horizontal
8	1291.6	-71.49	-68.27	-47.00	21.27	3.22	RMS	Horizontal
9	2980.6	-70.41	-56.77	-47.00	9.77	13.64	RMS	Horizontal
10	4481.025	-60.52	-62.16	-47.00	15.16	-1.64	RMS	Horizontal
11	6744.975	-64.12	-58.57	-47.00	11.57	5.55	RMS	Horizontal
12	12046.05	-68.95	-56.04	-47.00	9.04	12.91	RMS	Horizontal

Project No	E20220818423001	EUT:	Smart Video Doorbell G4
Model:	SVD-C01	Sample No:	E20220818423001-0001
Mode:	RX 802.11g 2472MHz	Voltage:	AC 24V by AC power convert from AC 230V/50Hz
Environment:	23.8°C/55%RH/101.0kPa	Engineer:	Zhang Zishan
Test Date:	2022-09-30	/	/

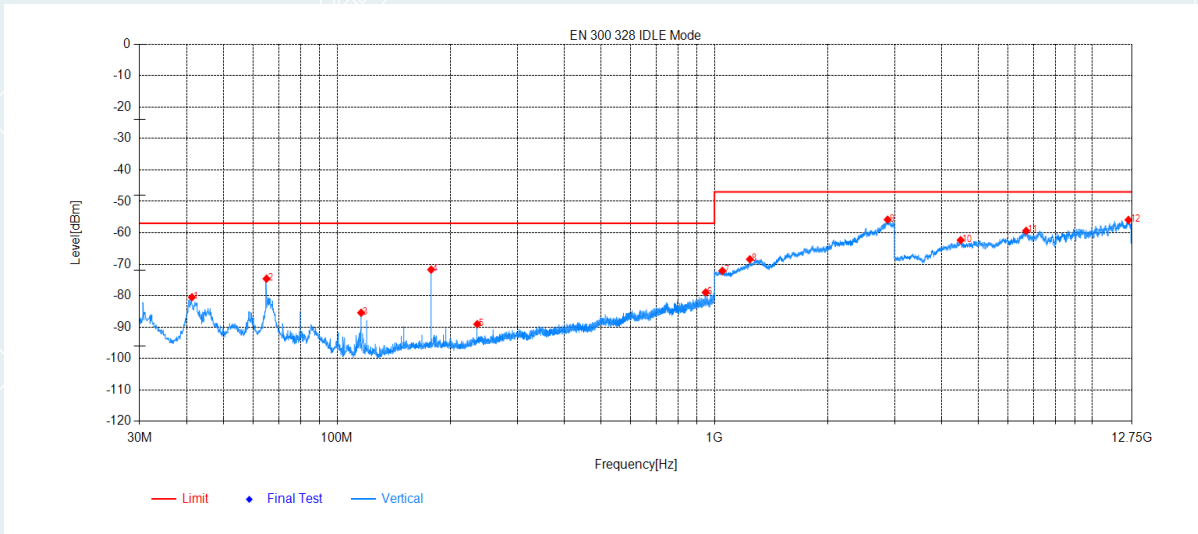

Suspected Data List								
NO.	Freq. [MHz]	Reading [dBm]	Level [dBm]	Limit [dBm]	Margin [dB]	Factor [dB]	Detector	Polarity
1	41.252	-66.56	-80.50	-57.00	23.50	-13.94	RMS	Vertical
2	65.017	-59.37	-74.59	-57.00	17.59	-15.22	RMS	Vertical
3	115.845	-65.43	-85.43	-57.00	28.43	-20.00	RMS	Vertical
4	177.537	-53.76	-71.72	-57.00	14.72	-17.96	RMS	Vertical
5	235.252	-73.14	-89.06	-57.00	32.06	-15.92	RMS	Vertical
6	947.62	-76.08	-78.97	-57.00	21.97	-2.89	RMS	Vertical
7	1049.2	-71.32	-72.09	-47.00	25.09	-0.77	RMS	Vertical
8	1241	-70.60	-68.43	-47.00	21.43	2.17	RMS	Vertical
9	2875	-69.47	-55.81	-47.00	8.81	13.66	RMS	Vertical
10	4489.8	-60.59	-62.33	-47.00	15.33	-1.74	RMS	Vertical
11	6694.275	-64.38	-59.37	-47.00	12.37	5.01	RMS	Vertical
12	12502.35	-70.47	-55.91	-47.00	8.91	14.56	RMS	Vertical

Project No	E20220818423001	EUT:	Smart Video Doorbell G4
Model:	SVD-C01	Sample No:	E20220818423001-0001
Mode:	RX 802.11n HT20 2412MHz	Voltage:	AC 24V by AC power convert from AC 230V/50Hz
Environment:	23.8°C/55%RH/101.0kPa	Engineer:	Zhang Zishan
Test Date:	2022-09-30	/	/

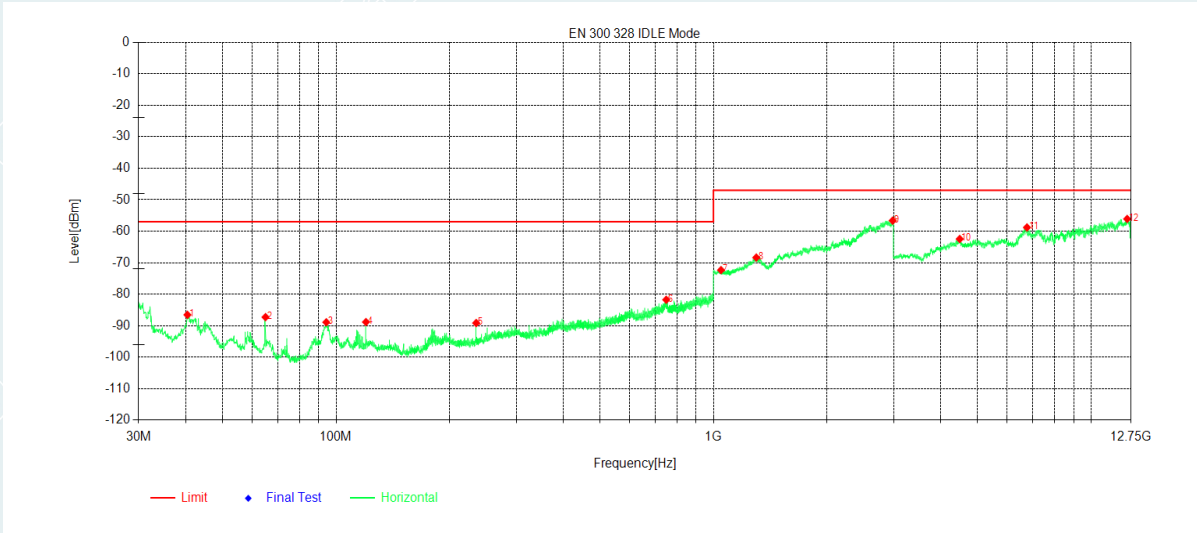

Suspected Data List								
NO.	Freq. [MHz]	Reading [dBm]	Level [dBm]	Limit [dBm]	Margin [dB]	Factor [dB]	Detector	Polarity
1	40.379	-72.58	-86.54	-57.00	29.54	-13.96	RMS	Horizontal
2	65.017	-67.63	-87.27	-57.00	30.27	-19.64	RMS	Horizontal
3	94.214	-72.02	-88.90	-57.00	31.90	-16.88	RMS	Horizontal
4	120.016	-70.31	-88.83	-57.00	31.83	-18.52	RMS	Horizontal
5	235.155	-72.46	-89.14	-57.00	32.14	-16.68	RMS	Horizontal
6	749.546	-78.24	-81.76	-57.00	24.76	-3.52	RMS	Horizontal
7	1047.2	-71.22	-72.34	-47.00	25.34	-1.12	RMS	Horizontal
8	1298.6	-71.47	-68.35	-47.00	21.35	3.12	RMS	Horizontal
9	2983.4	-70.21	-56.63	-47.00	9.63	13.58	RMS	Horizontal
10	4492.725	-60.88	-62.46	-47.00	15.46	-1.58	RMS	Horizontal
11	6772.275	-63.92	-58.80	-47.00	11.80	5.12	RMS	Horizontal
12	12477	-70.07	-56.09	-47.00	9.09	13.98	RMS	Horizontal

Project No	E20220818423001	EUT:	Smart Video Doorbell G4
Model:	SVD-C01	Sample No:	E20220818423001-0001
Mode:	RX 802.11n HT20 2412MHz	Voltage:	AC 24V by AC power convert from AC 230V/50Hz
Environment:	23.8°C/55%RH/101.0kPa	Engineer:	Zhang Zishan
Test Date:	2022-09-30	/	/

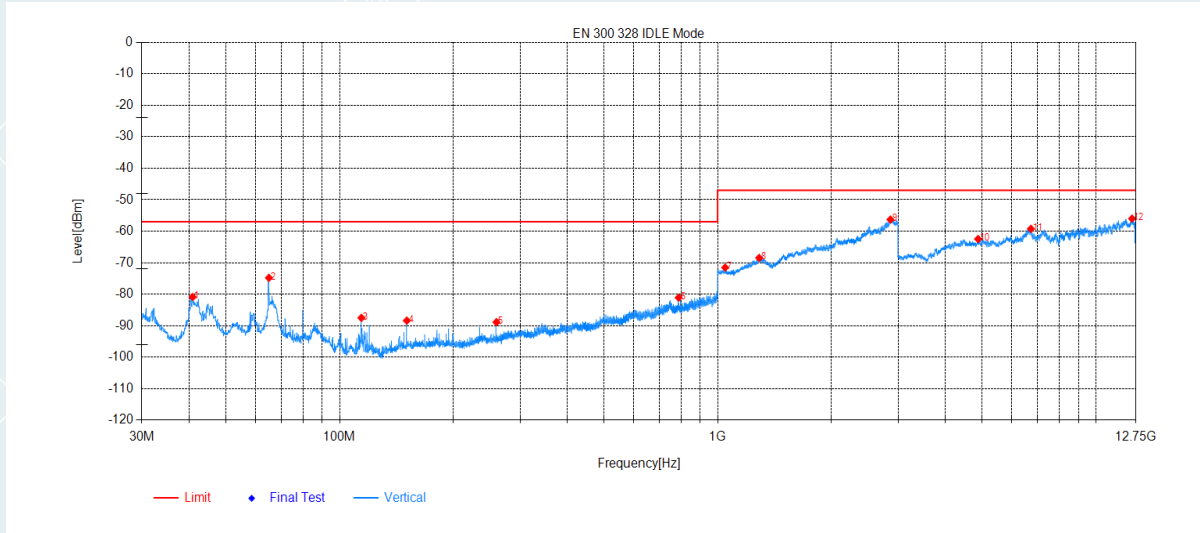

Suspected Data List								
NO.	Freq. [MHz]	Reading [dBm]	Level [dBm]	Limit [dBm]	Margin [dB]	Factor [dB]	Detector	Polarity
1	40.864	-66.91	-80.87	-57.00	23.87	-13.96	RMS	Vertical
2	65.017	-59.57	-74.79	-57.00	17.79	-15.22	RMS	Vertical
3	114.196	-67.52	-87.51	-57.00	30.51	-19.99	RMS	Vertical
4	150.571	-69.69	-88.38	-57.00	31.38	-18.69	RMS	Vertical
5	259.89	-72.47	-88.86	-57.00	31.86	-16.39	RMS	Vertical
6	788.54	-76.80	-81.08	-57.00	24.08	-4.28	RMS	Vertical
7	1046.6	-70.62	-71.53	-47.00	24.53	-0.91	RMS	Vertical
8	1287.8	-71.43	-68.47	-47.00	21.47	2.96	RMS	Vertical
9	2864.6	-69.85	-56.30	-47.00	9.30	13.55	RMS	Vertical
10	4885.65	-61.41	-62.46	-47.00	15.46	-1.05	RMS	Vertical
11	6740.1	-64.98	-59.23	-47.00	12.23	5.75	RMS	Vertical
12	12478.95	-70.16	-55.98	-47.00	8.98	14.18	RMS	Vertical

Project No	E20220818423001	EUT:	Smart Video Doorbell G4
Model:	SVD-C01	Sample No:	E20220818423001-0001
Mode:	RX 802.11n HT20 2472MHz	Voltage:	AC 24V by AC power convert from AC 230V/50Hz
Environment:	23.8°C/55%RH/101.0kPa	Engineer:	Zhang Zishan
Test Date:	2022-09-30	/	/

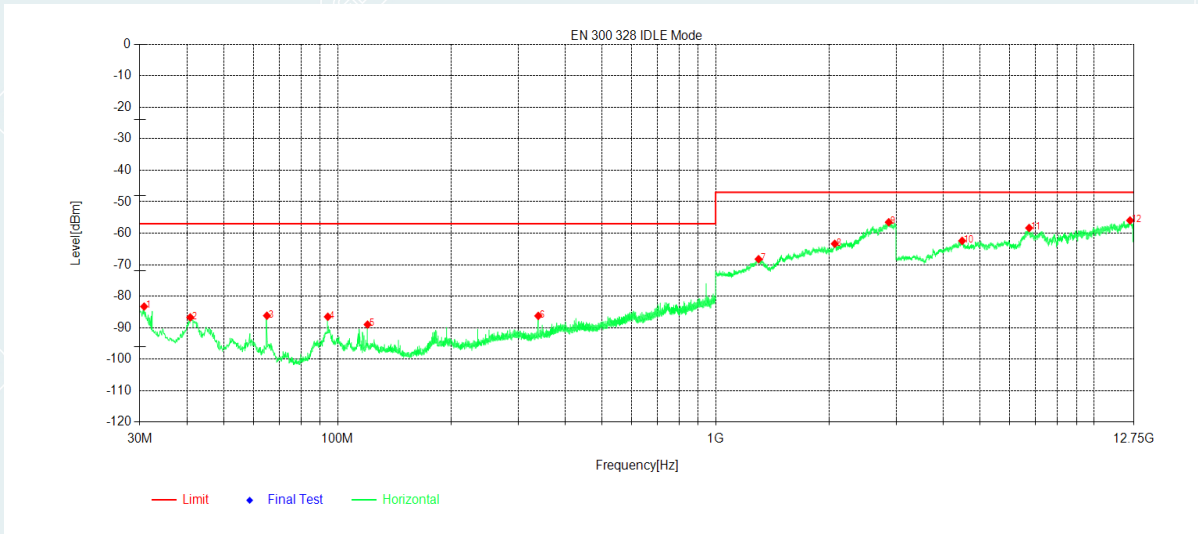

Suspected Data List								
NO.	Freq. [MHz]	Reading [dBm]	Level [dBm]	Limit [dBm]	Margin [dB]	Factor [dB]	Detector	Polarity
1	30.776	-68.36	-83.27	-57.00	26.27	-14.91	RMS	Horizontal
2	40.767	-72.64	-86.71	-57.00	29.71	-14.07	RMS	Horizontal
3	65.017	-66.54	-86.18	-57.00	29.18	-19.64	RMS	Horizontal
4	94.214	-69.64	-86.52	-57.00	29.52	-16.88	RMS	Horizontal
5	120.016	-70.47	-88.99	-57.00	31.99	-18.52	RMS	Horizontal
6	339.43	-72.06	-86.24	-57.00	29.24	-14.18	RMS	Horizontal
7	1298.8	-71.34	-68.23	-47.00	21.23	3.11	RMS	Horizontal
8	2065.8	-71.03	-63.34	-47.00	16.34	7.69	RMS	Horizontal
9	2870.4	-69.67	-56.50	-47.00	9.50	13.17	RMS	Horizontal
10	4487.85	-60.82	-62.42	-47.00	15.42	-1.60	RMS	Horizontal
11	6748.875	-63.94	-58.33	-47.00	11.33	5.61	RMS	Horizontal
12	12479.92	-69.98	-55.94	-47.00	8.94	14.04	RMS	Horizontal

Project No	E20220818423001	EUT:	Smart Video Doorbell G4
Model:	SVD-C01	Sample No:	E20220818423001-0001
Mode:	RX 802.11n HT20 2472MHz	Voltage:	AC 24V by AC power convert from AC 230V/50Hz
Environment:	23.8°C/55%RH/101.0kPa	Engineer:	Zhang Zishan
Test Date:	2022-09-30	/	/

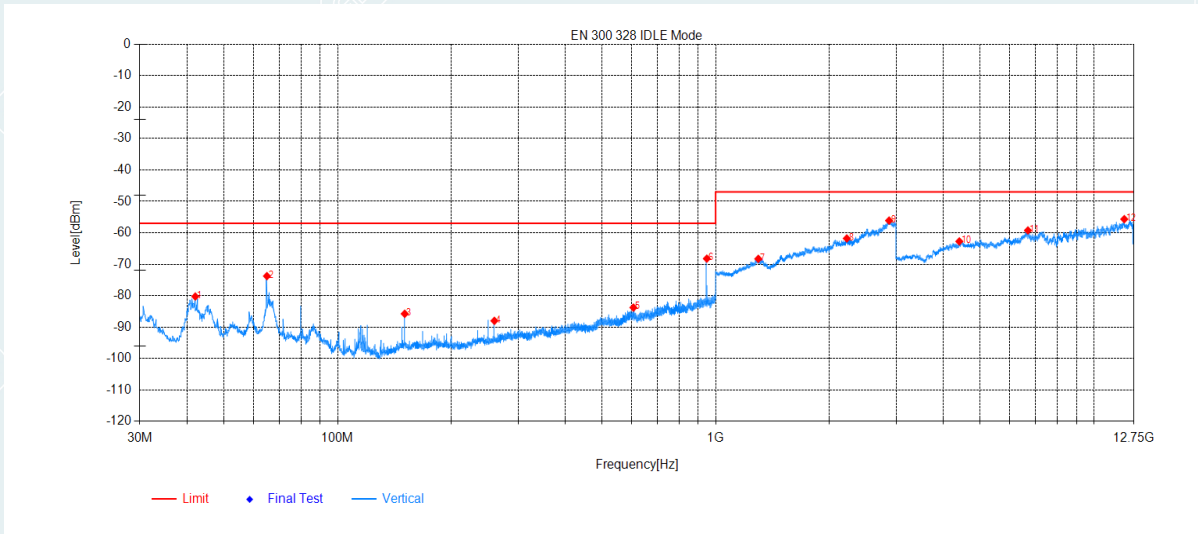

Suspected Data List								
NO.	Freq. [MHz]	Reading [dBm]	Level [dBm]	Limit [dBm]	Margin [dB]	Factor [dB]	Detector	Polarity
1	42.028	-66.36	-80.26	-57.00	23.26	-13.90	RMS	Vertical
2	65.017	-58.55	-73.77	-57.00	16.77	-15.22	RMS	Vertical
3	150.474	-67.07	-85.76	-57.00	28.76	-18.69	RMS	Vertical
4	259.89	-71.61	-88.00	-57.00	31.00	-16.39	RMS	Vertical
5	605.986	-76.47	-83.78	-57.00	26.78	-7.31	RMS	Vertical
6	947.62	-65.32	-68.21	-57.00	11.21	-2.89	RMS	Vertical
7	1296.6	-71.26	-68.28	-47.00	21.28	2.98	RMS	Vertical
8	2222.8	-70.27	-61.79	-47.00	14.79	8.48	RMS	Vertical
9	2875.8	-69.77	-56.11	-47.00	9.11	13.66	RMS	Vertical
10	4410.825	-60.73	-62.73	-47.00	15.73	-2.00	RMS	Vertical
11	6699.15	-64.26	-59.23	-47.00	12.23	5.03	RMS	Vertical
12	12046.05	-68.70	-55.66	-47.00	8.66	13.04	RMS	Vertical

5.8 RECEIVER BLOCKING

Test Requirement: EN300 328 V2.2.2/ 4.3.2.11

Test Method: EN300 328 V2.2.2/5.4.11.2.1

5.8.1 LIMIT

For equipment that supports a PER or FER test to be performed, the minimum performance criterion shall be a PER or FER less than or equal to 10 %.

For equipment that does not support a PER or a FER test to be performed, the minimum performance criterion shall be no loss of the wireless transmission function needed for the intended use of the equipment.

The blocking levels at specified frequency offsets shall be equal to or greater than the limits defined for.

Receiver Blocking parameters for Receiver Category 1 equipment

Wanted signal mean power from companion device (dBm) (see notes 1 and 4)	Blocking Signal frequency (MHz)	Blocking signal power (dBm) (see note 4)	Type of blocking signal
$(-133\text{dBm} + 10 \times \log_{10}(\text{OCBW}))$ or -68dBm whichever is less (see note 2)	2380 2504	-34	CW
$(-139\text{dBm} + 10 \times \log_{10}(\text{OCBW}))$ or -74dBm whichever is less (see note 3)	2300 2330 2360 2524 2584 2674		
NOTE 1: OCBW is in Hz.			
NOTE 2: In case of radiated measurements using a companion device and the level of the wanted signal from the companion device cannot be determined, a relative test may be performed using a wanted signal up to $P_{\min} + 26$ dB where P_{\min} is the minimum level of wanted signal required to meet the minimum performance criteria as defined in clause 4.3.1.12.3 in the absence of any blocking signal.			
NOTE 3: In case of radiated measurements using a companion device and the level of the wanted signal from the companion device cannot be determined, a relative test may be performed using a wanted signal up to $P_{\min} + 20$ dB where P_{\min} is the minimum level of wanted signal required to meet the minimum performance criteria as defined in clause 4.3.1.12.3 in the absence of any blocking signal.			
NOTE 4: The level specified is the level at the UUT receiver input assuming a 0 dBi antenna assembly gain. In case of conducted measurements, this level has to be corrected for the (in-band) antenna assembly gain (G). In case of radiated measurements, this level is equivalent to a power flux density (PFD) in front of the UUT antenna with the UUT being configured/positioned as recorded in clause 5.4.3.2.2.			

Receiver Blocking parameters for Receiver Category 2 equipment

Wanted signal mean power from companion device (dBm) (see notes 1 and 3)	Blocking Signal frequency (MHz)	Blocking signal power (dBm) (see note 3)	Type of blocking signal
$(-139\text{dBm} + 10 \times \log_{10}(\text{OCBW}) + 10\text{dBm})$ or $(-74\text{dBm} + 10\text{dBm})$ whichever is less (see note 2)	2380 2504 2300 2584	-34	CW
NOTE 1: OCBW is in Hz.			
NOTE 2: In case of radiated measurements using a companion device and the level of the wanted signal from the companion device cannot be determined, a relative test may be performed using a			

wanted signal up to $P_{min} + 26$ dB where P_{min} is the minimum level of wanted signal required to meet the minimum performance criteria as defined in clause 4.3.1.12.3 in the absence of any blocking signal.

NOTE 3: The level specified is the level at the UUT receiver input assuming a 0 dBi antenna assembly gain. In case of conducted measurements, this level has to be corrected for the (in-band) antenna assembly gain (G). In case of radiated measurements, this level is equivalent to a power flux density (PFD) in front of the UUT antenna with the UUT being configured/positioned as recorded in clause 5.4.3.2.2.

Receiver Blocking parameters for Receiver Category 3 equipment

Wanted signal mean power from companion device (dBm) (see notes 1 and 3)	Blocking Signal frequency (MHz)	Blocking signal power (dBm) (see note 3)	Type of blocking signal
(-139dBm+10 × log ₁₀ (OCBW)+20dBm) or (-74dBm+20dBm) whichever is less (see note 2)	2380 2504 2300 2584	-34	CW

NOTE 1: OCBW is in Hz.

NOTE 2: In case of radiated measurements using a companion device and the level of the wanted signal from the companion device cannot be determined, a relative test may be performed using a wanted signal up to $P_{min} + 30$ dB where P_{min} is the minimum level of wanted signal required to meet the minimum performance criteria as defined in clause 4.3.1.12.3 in the absence of any blocking signal.

NOTE 3: The level specified is the level at the UUT receiver input assuming a 0 dBi antenna assembly gain. In case of conducted measurements, this level has to be corrected for the (in-band) antenna assembly gain (G). In case of radiated measurements, this level is equivalent to a power flux density (PFD) in front of the UUT antenna with the UUT being configured/positioned as recorded in clause 5.4.3.2.2.

5.8.2 TEST CONFIGURATION

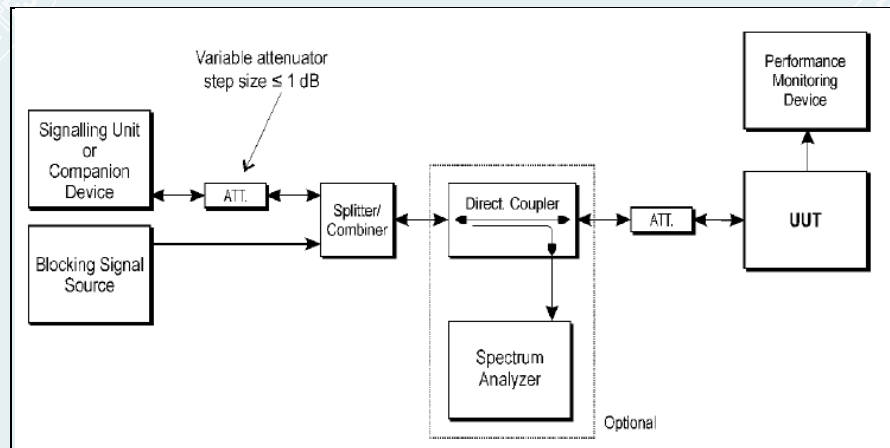

5.8.3 TEST PROCEDURES

Test condition: Keep the EUT on the lowest and highest channel working mode.

Test procedure: Step1:

Test condition: For non-FHSS equipment, the UUT shall be set to the lowest operating channel on which the blocking test has to be performed (see clause 5.4.11.1).

Step 2:

The blocking signal generator is set to the first frequency as defined in the appropriate table corresponding to the receiver category and type of equipment.

Step 3:

With the blocking signal generator switched off, a communication link is established between the UUT and the associated companion device using the test setup shown in figure 6.

Unless the option provided in note 2 of the applicable table referred to in clause 5.4.11.2.1 is used, the level of the wanted signal shall be set to the value provided in the table corresponding to the receiver category and type of equipment. The test procedure defined in clause 5.4.2, and more in particular clause 5.4.2.2.1.2, can be used to measure the (conducted) level of the wanted signal however no correction shall be made for antenna gain of

the companion device (step 6 in clause 5.4.2.2.1.2 shall be ignored). This level may be measured directly at the output of the companion device and a correction is made for the coupling loss into the UUT. The actual level for the wanted signal shall be recorded in the test report.

•When the option provided in note 2 of the applicable table referred to in clause 5.4.11.2.1 is used, the attenuation of the variable attenuator shall be increased in 1 dB steps to a value at which the minimum performance criteria as specified in clause 4.3.1.12.3 or clause 4.3.2.11.3 is still met. The resulting level for the wanted signal at the input of the UUT is P_{min} . This signal level (P_{min}) is increased by the value provided in note 2 of the applicable table corresponding to the receiver category and type of equipment.

Step 4:

The blocking signal at the UUT is set to the level provided in the table corresponding to the receiver category and type of equipment.

If the performance criteria as specified in clause 4.3.1.12.3 or clause 4.3.2.11.3 are met then proceed to step 6.

Step 5:

If the performance criteria as specified in clause 4.3.1.12.3 or clause 4.3.2.11.3 is not met, step 3 and step 4 shall be repeated after that the frequency of the blocking signal set in step 2 has been increased with a value equal to the Occupied Channel Bandwidth except:

- For the blocking frequency 2 380 MHz, where this frequency offset shall be less than or equal to 10 MHz. If this frequency offset is more than 7 MHz, the level of the wanted signal shall be increased by 3 dB.

- For the blocking frequency 2 503,5 MHz, where this frequency offset shall be less than or equal to 10 MHz. If this frequency offset is more than 7 MHz, the level of the wanted signal shall be decreased by 3 dB.

If the performance criteria as specified in clause 4.3.1.12.3 or clause 4.3.2.11.3 is still not met, step 3 and step 4 shall be repeated after that the frequency of the blocking signal set in step 2 has been decreased with a value equal to the Occupied Channel Bandwidth except:

- For the blocking frequency 2 380 MHz, where this frequency offset shall be less than or equal to 10 MHz. If this frequency offset is more than 7 MHz, the level of the wanted signal shall be decreased by 3 dB.

- For the blocking frequency 2 503,5 MHz, where this frequency offset shall be less than or equal to 10 MHz. If this frequency offset is more than 7 MHz, the level of the wanted signal shall be increased by 3 dB.

If the performance criteria as specified in clause 4.3.1.12.3 or clause 4.3.2.11.3 is still

not met, the UUT fails to comply with the Receiver Blocking requirement and step 6 and step 7 are no longer required.

It shall be recorded in the test report whether the shift of blocking frequencies as described in the present step was used.

Step 6:

Repeat step 4 and step 5 for each remaining combination of frequency and level for the blocking signal as provided in the table corresponding to the receiver category and type of equipment.

Step 7

For non-FHSS equipment, repeat step 2 to step 6 with the UUT operating at the highest operating channel on which the blocking test has to be performed (see clause 5.4.11.1).

Step 8

It shall be assessed and recorded in the test report whether the UUT complies with the Receiver Blocking requirement.

Keep the EUT on the lowest and highest channel working mode.

Remark:

If the equipment can be configured to operate with different Nominal Channel Bandwidths (e.g. 20 MHz and 40 MHz) and different data rates, then the combination of the smallest channel bandwidth and the lowest data rate for this channel bandwidth which still allows the equipment to operate as intended shall be used.

Test channel:

2412MHz, 2472MHz for 802.11b

5.8.4 TEST RESULTS

Test environment: Normal condition:
23.8°C/51%RH/101.0kPa

Test Engineer: Qin Tingting

Test Date: 2022-08-29

Test Mode	Antenna	Frequency [MHz]	Wanted signal [dBm]	Frequency [MHz]	CW [dBm]	PER [%]	Limit [%]	Verdict
802.11b	Ant1	2412	-73.5	2300	-33.5	0.30	≤10	PASS
			-73.5	2330	-33.5	0.50	≤10	PASS
			-73.5	2360	-33.5	0.10	≤10	PASS
			-67.5	2380	-33.5	0.00	≤10	PASS
		2472	-67.5	2504	-33.5	2.50	≤10	PASS
			-73.5	2524	-33.5	2.40	≤10	PASS
			-73.5	2584	-33.5	1.70	≤10	PASS
			-73.5	2674	-33.5	7.00	≤10	PASS

Remark: CW=signal power(-34dBm) + Antenna Gain(0.5dBi).

Test Graphs

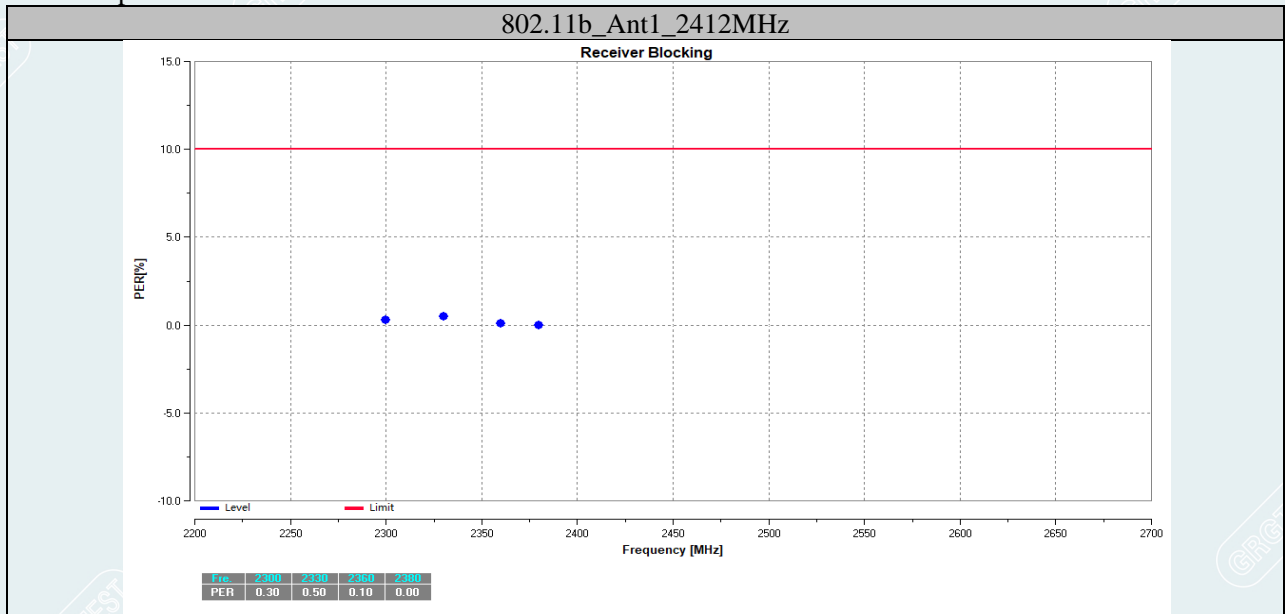

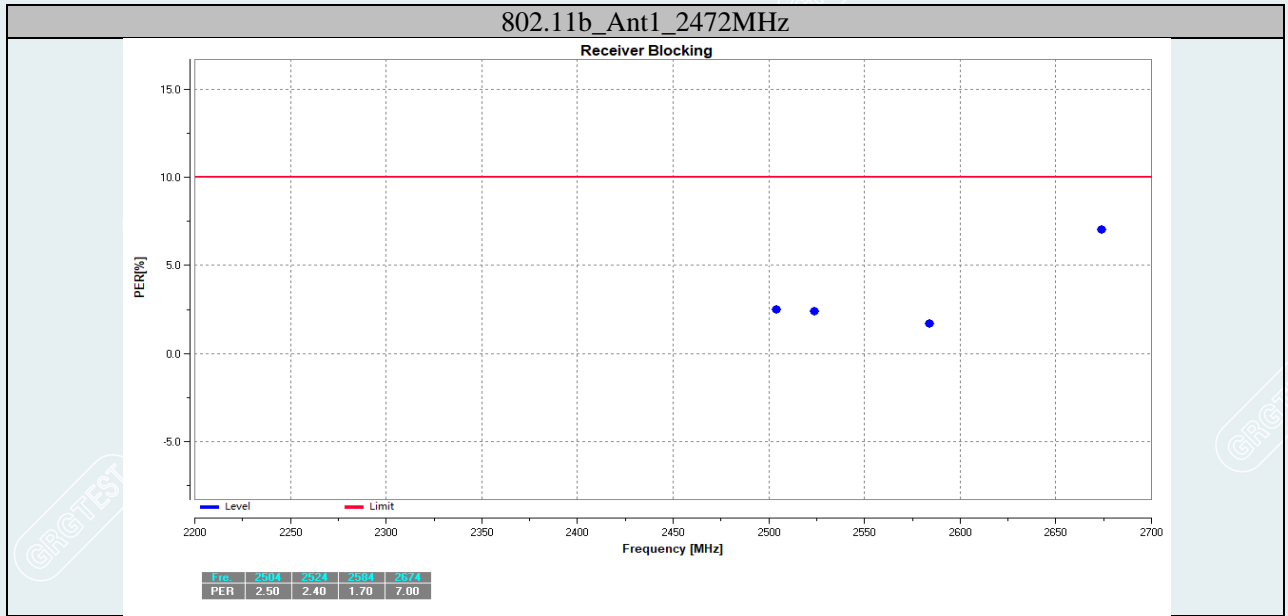

----- The following blanks -----

APPENDIX A. PHOTOGRAPH OF THE TEST CONNECTION DIAGRAM

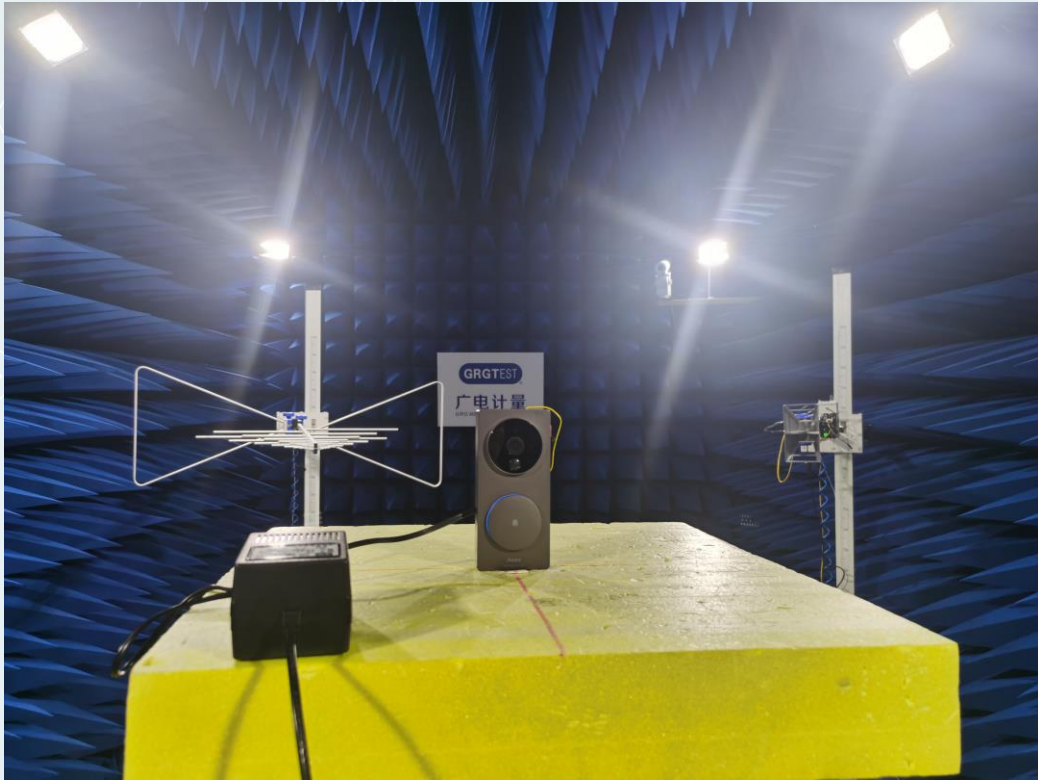

RSE

APPENDIX B. PHOTOGRAPH OF THE EUT

SVD-C01 External Photos of EUT



EUT-1

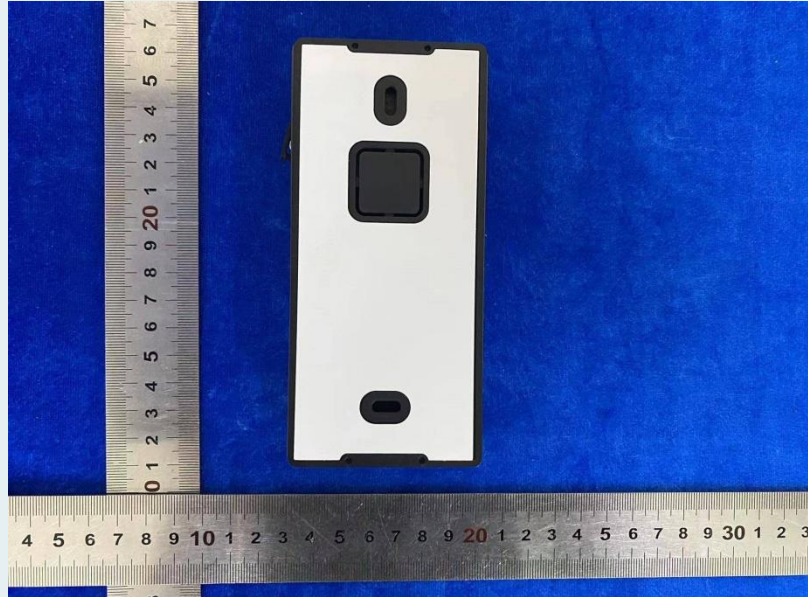

EUT-2

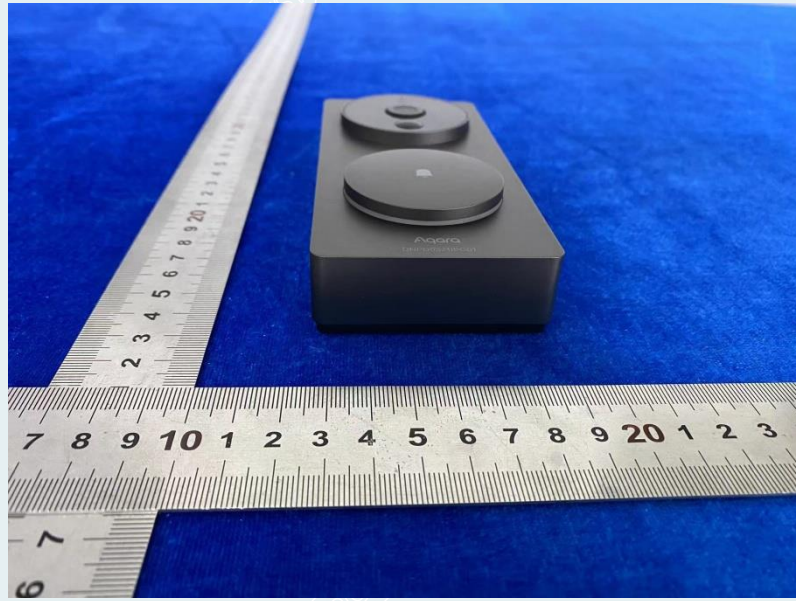

EUT-3

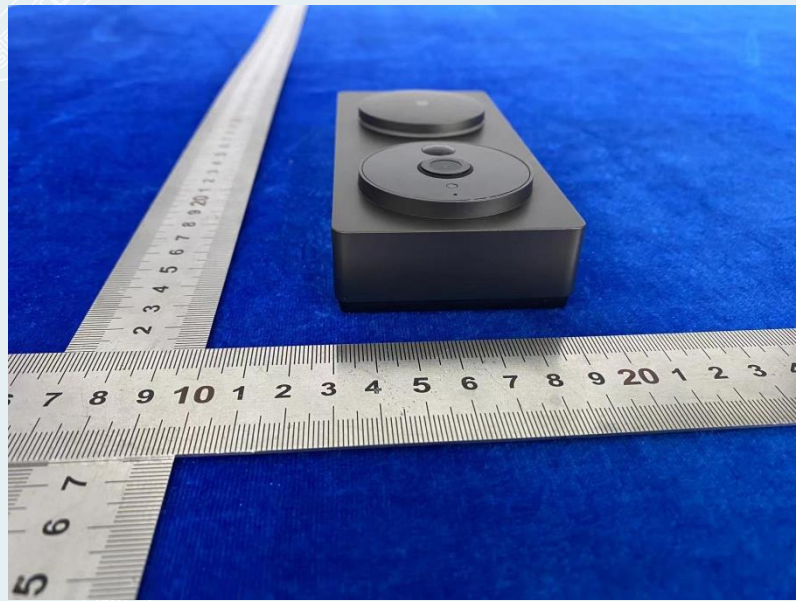

EUT-4



EUT-5



EUT-6

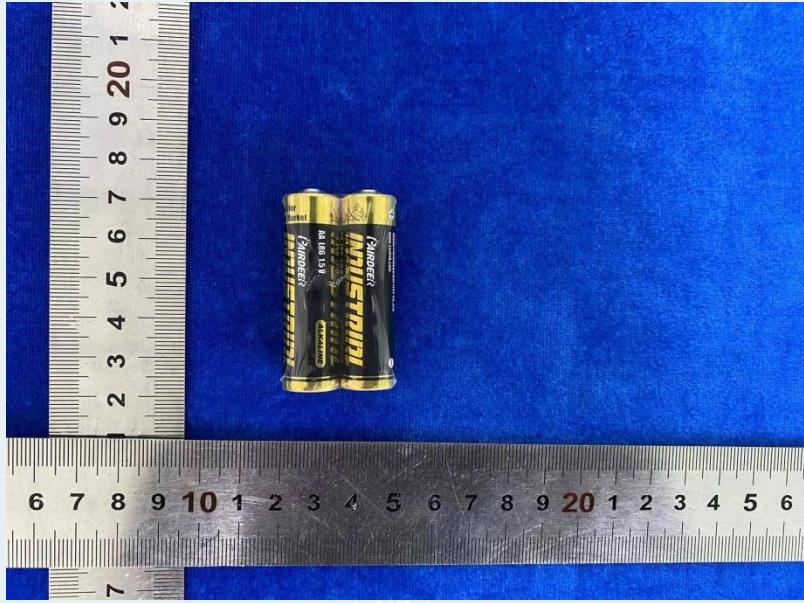

EUT-7

SVD-C01 Internal Photos of EUT



EUT-1

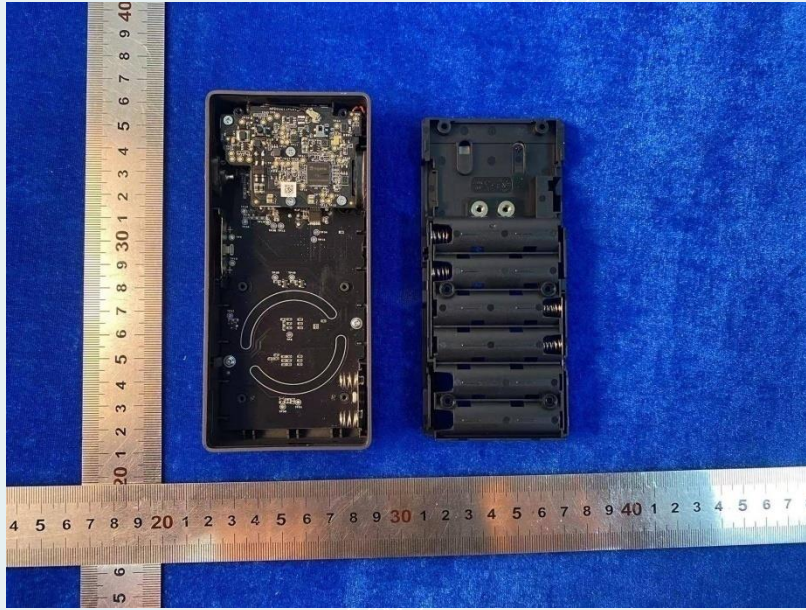

EUT-2

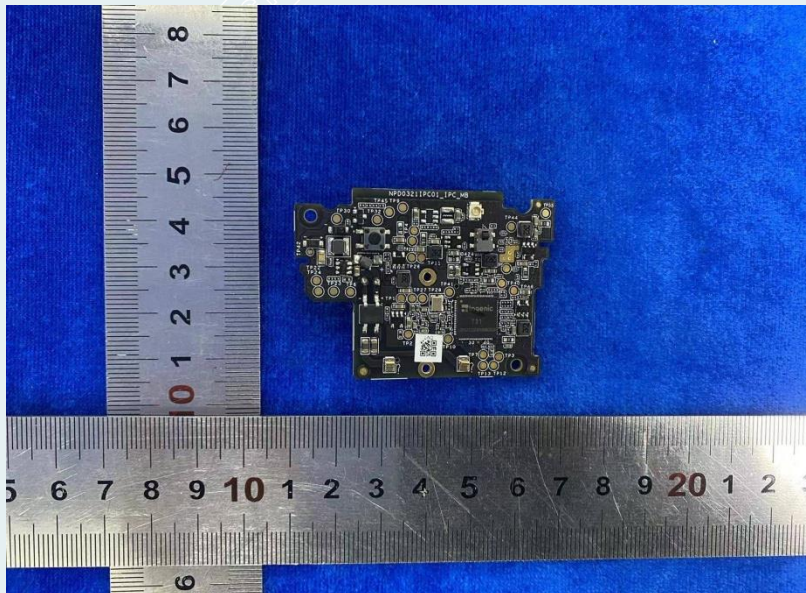

EUT-3

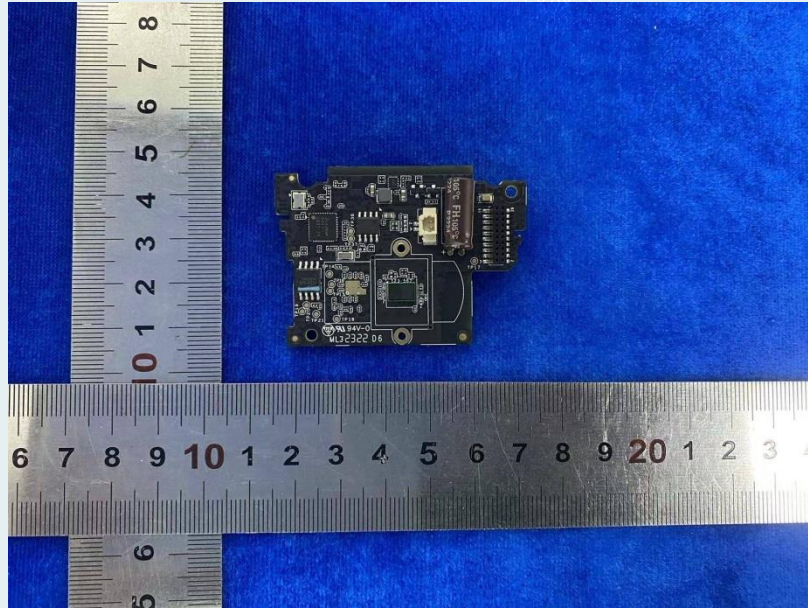

EUT-4

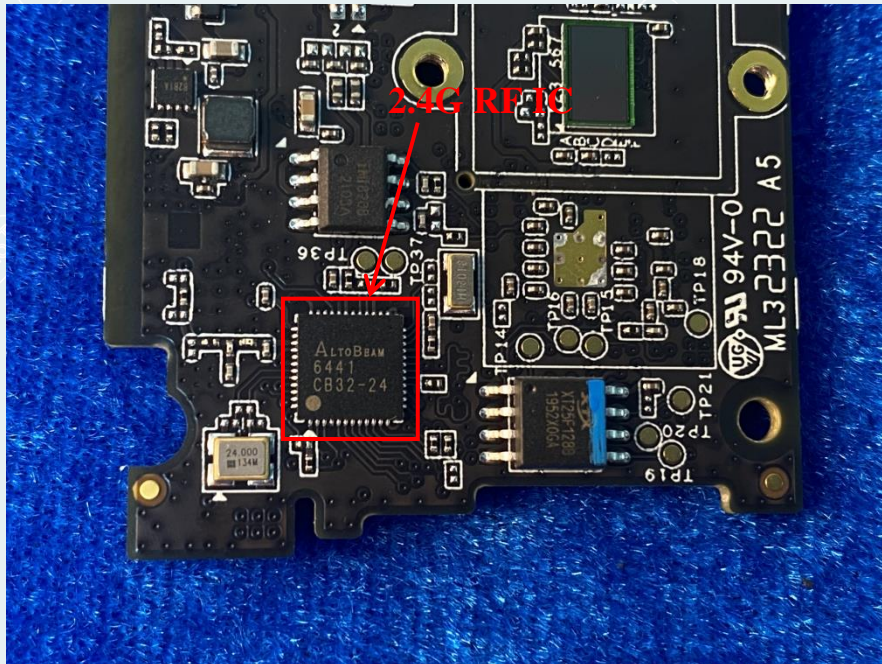

EUT-5

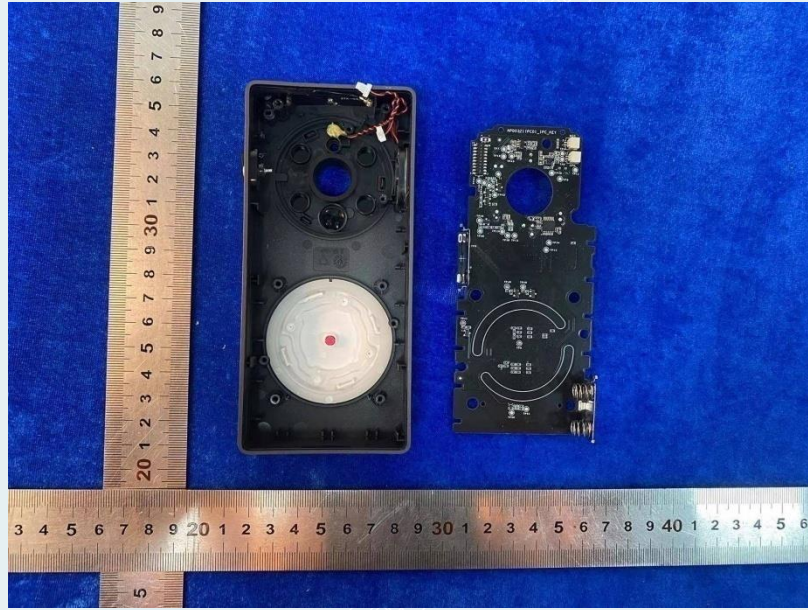

EUT-6

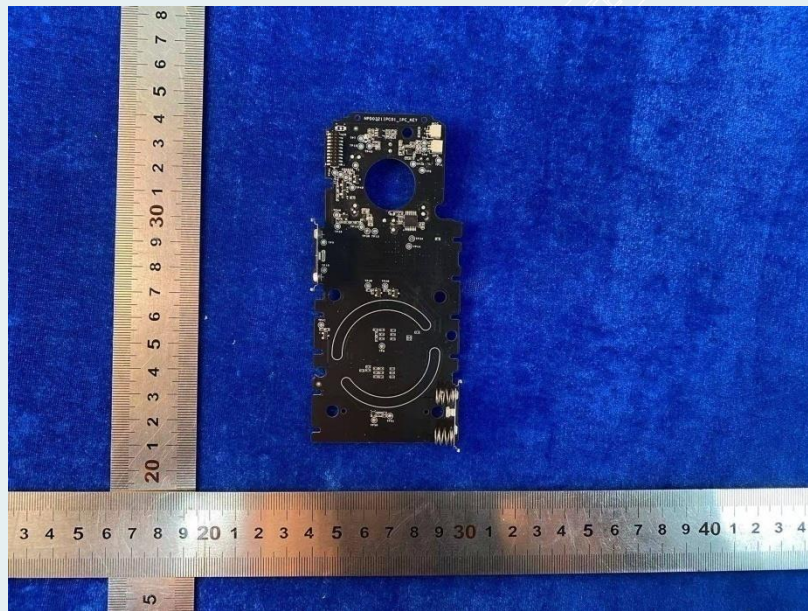

EUT-7

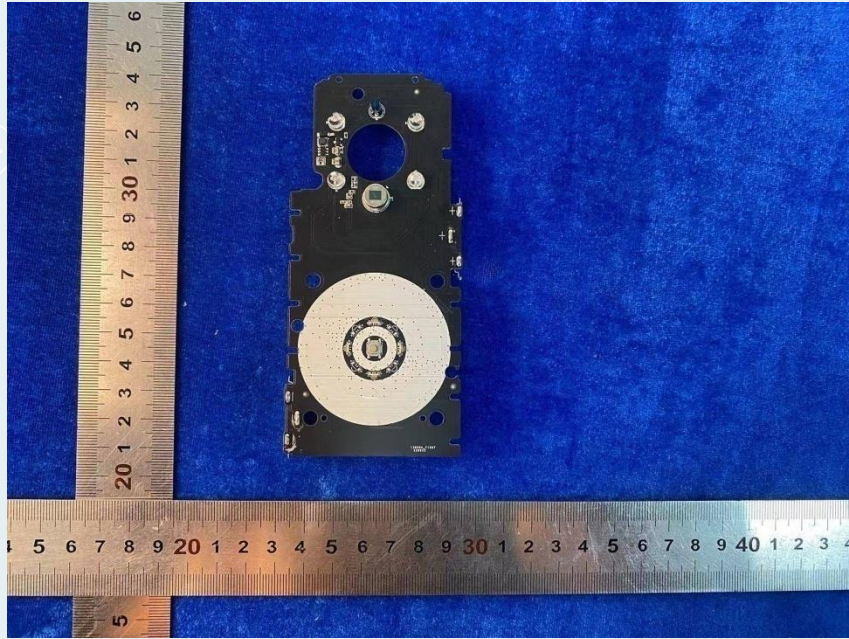

EUT-8



EUT-9

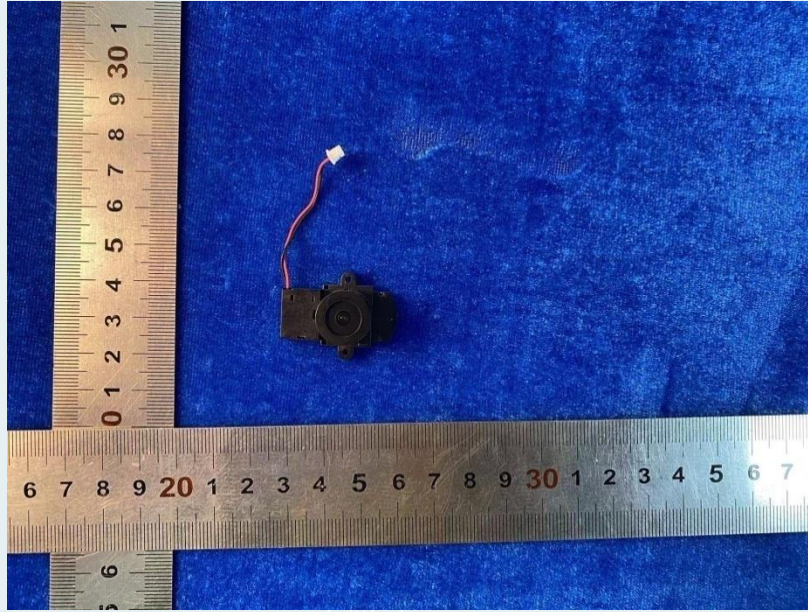

EUT-10

SVD-C03 External Photos of EUT



EUT-1

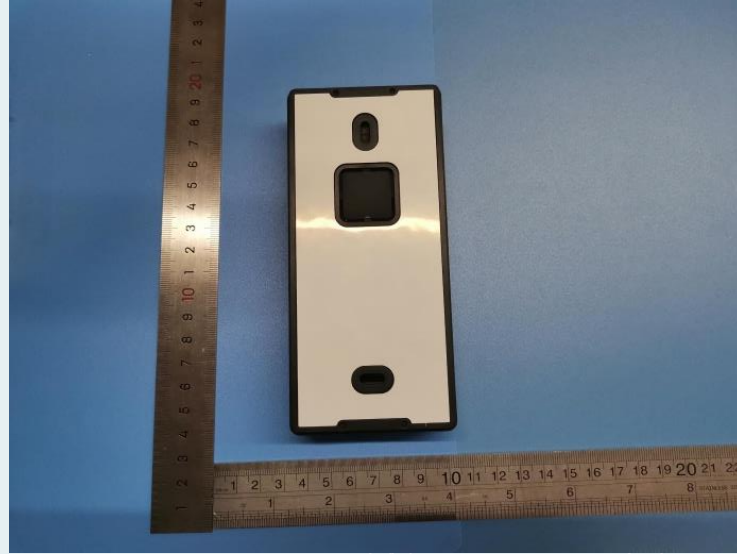

EUT-2



EUT-3



EUT-4



EUT-5



EUT-6

----- **End of Report** -----