

CE SAR EVALUATION REPORT

In accordance with the requirements of
**EN50360, EN50566, EN62209-1/-2, EN62479 and COUNCIL
RECOMMENDATION 1999/519/EC**

Product Name : Mobile Phone

Trademark : Blackview

Model Name : A95

Family Model : N/A

Report No. : STR211122001012E

Prepared for

DOKE COMMUNICATION (HK) LIMITED

RM 1902 EASEY COMM BLDG 253-261 HENNESSY ROAD WANCHAI HK, CHINA

Prepared by

Shenzhen NTEK Testing Technology Co., Ltd.

1/F, Building E, Fenda Science Park, Sanwei Community, Xixiang Street,

Bao'an District, Shenzhen 518126 P.R.China.

Tel. 400-800-6106, 0755-2320 0050, 0755-2320 0090

Website: <http://www.ntek.org.cn>

TEST RESULT CERTIFICATION

Applicant's name..... : DOKE COMMUNICATION (HK) LIMITED
 Address..... : RM 1902 EASEY COMM BLDG 253-261 HENNESSY ROAD
 WANCHAI HK, CHINA
Manufacturer's Name : Shenzhen DOKE Electronic Co.,Ltd.
 Address..... : 801, Building3, 7th Industrial Zone, Yulv Community, Yutang Road,
 Guangming District, Shenzhen, China.

Product description

Product name..... : Mobile Phone
 Trademark : Blackview
 Model and/or type reference : A95
 Family Model..... : N/A

EN 50360:2017;
 EN 50566:2017;

Standards..... : EN 62209-1:2016;
 EN 62209-2:2010;
 EN 62479:2010;

This device described above has been tested by Shenzhen NTEK. In accordance with the measurement methods and procedures specified in EN62209. Testing has shown that this device is capable of compliance with localized specific absorption rate (SAR) specified in COUNCIL 1999/519/EC. The test results in this report apply only to the tested sample of the stated device/equipment. Other similar device/equipment will not necessarily produce the same results due to production tolerance and measurement uncertainties.

This report shall not be reproduced except in full, without the written approval of Shenzhen NTEK, this document may be altered or revised by Shenzhen NTEK, personal only, and shall be noted in the revision of the document.

Date of Test

Date (s) of performance of tests..... Nov. 26, 2021 ~ Dec. 06, 2021
 Date of Issue Jan. 10, 2022
 Test Result **Pass**

Prepared By : Jacob Chen
 (Test Engineer) : (Jacob Chen)

Approved By : Alex
 (Lab Manager) : (Alex Li)

※ ※ Revision History ※ ※

REV.	DESCRIPTION	ISSUED DATE	REMARK
Rev.1.0	Initial Test Report Release	Jan. 10, 2022	Jacob Chen

TABLE OF CONTENTS

1. General Information	6
1.1. RF exposure limits	6
1.2. Statement of Compliance.....	7
1.3. EUT Description	7
1.4. Test specification(s)	9
1.5. Ambient Condition.....	9
2. SAR Measurement System	10
2.1. SATIMO SAR Measurement Set-up Diagram	10
2.2. Robot	11
2.3. E-Field Probe.....	12
2.3.1. E-Field Probe Calibration.....	12
2.4. SAM phantoms	13
2.4.1. Technical Data	14
2.5. Device Holder	15
2.6. Test Equipment List	16
3. SAR Measurement Procedures	18
3.1. Power Reference.....	18
3.2. Area scan & Zoom scan	18
3.3. Description of interpolation/extrapolation scheme	19
3.4. Volumetric Scan	19
3.5. Power Drift	19
4. System Verification Procedure.....	20
4.1. Tissue Verification.....	20
4.1.1. Tissue Dielectric Parameter Check Results	21
4.2. System Verification Procedure	22
4.2.1. System Verification Results	23
5. SAR Measurement Uncertainty.....	24
6. RF Exposure Positions	25
6.1. Ear and handset reference point.....	25
6.2. Definition of the cheek position	25
6.3. Definition of the tilt position.....	27
6.4. Body-worn device	27
7. RF Output Power	28
7.1. GSM Conducted Power	28
7.2. WCDMA Conducted Power.....	29
7.3. LTE Conducted Power.....	29
7.4. WLAN & Bluetooth Output Power.....	36
8. Assessment of the compliance of low power equipment.....	37
9. SAR Results	37

9.1. SAR measurement results	37
9.1.1. SAR measurement Result of GSM900.....	37
9.1.2. SAR measurement Result of GSM1800.....	38
9.1.3. SAR measurement Result of WCDMA Band 1.....	39
9.1.4. SAR measurement Result of WCDMA Band 8.....	40
9.1.5. SAR measurement Result of LTE Band 1	41
9.1.6. SAR measurement Result of LTE Band 3	42
9.1.7. SAR measurement Result of LTE Band 7	42
9.1.8. SAR measurement Result of LTE Band 8	43
9.1.9. SAR measurement Result of LTE Band 20	44
9.1.10. SAR measurement Result of LTE Band 40	45
9.1.11. SAR measurement Result of WLAN 2.4G.....	46
9.2. Simultaneous Transmission Analysis.....	47
9.3. Exposure Conditions	47
10. Appendix A. Photo documentation.....	49
11. Appendix B. System Check Plots	50
12. Appendix C. Plots of High SAR Measurement	63
13. Appendix D. Calibration Certificate.....	108

1. General Information

1.1. RF exposure limits

(A).Limits for Occupational/Controlled Exposure (W/kg)

Whole-Body	Partial-Body	Hands, Wrists, Feet and Ankles
0.4	10.0	20.0

(B).Limits for General Population/Uncontrolled Exposure (W/kg)

Whole-Body	Partial-Body	Hands, Wrists, Feet and Ankles
0.08	2.0	4.0

NOTE: **Whole-Body SAR** is averaged over the entire body, **partial-body SAR** is averaged over any 10 gram of tissue defined as a tissue volume in the shape of a cube.

SAR for hands, wrists, feet and ankles is averaged over any 10 grams of tissue defined as a tissue volume in the shape of a cube.

Occupational/Controlled Environments:

Are defined as locations where there is exposure that may be incurred by people who are aware of the potential for exposure, (i.e. as a result of employment or occupation).

General Population/Uncontrolled Environments:

Are defined as locations where there is the exposure of individuals who have no knowledge or control of their exposure.

NOTE
 HEAD AND TRUNK LIMIT
 2.0 W/kg AND MEMBER LIMIT 4.0 W/kg
 APPLIED TO THIS EUT

1.2. Statement of Compliance

The maximum results of Specific Absorption Rate (SAR) found during testing for A95 are as follows.

RF Exposure Conditions	Max SAR Value(W/kg)		
	10-g Head	10-g Body & Hotspot (Separation distance of 5mm)	10-g Member DAS (See note ³) (Separation distance of 0mm)
	0.378	0.633	1.995
Max Simultaneous Tx	0.512	0.734	2.516

NOTE: 1. The Max Simultaneous Tx is calculated based on the same configuration and test position.

2. This device is in compliance with Specific Absorption Rate (SAR) for general population / uncontrolled exposure limits (2.0 W/kg for head and body, 4.0 W/kg for member) specified in COUNCIL RECOMMENDATION 1999/519/EC, and had been tested in accordance with the measurement methods and procedures specified in EN 62209-1:2016 & EN 62209-2:2010.

3. The member DAS, It is only an assessment required by the ANFR (Sell to France).

1.3. EUT Description

Device Information	
Product Name	Mobile Phone
Trademark	Blackview
Model Name	A95
Family Model	N/A
Device Phase	Identical Prototype
Exposure Category	General population / Uncontrolled environment
Antenna Type	PIFA Antenna
Battery Information	Battery 1: Model: Li426483PUJLY DC 3.85V, 4280mAh, 16.48Wh Battery 2: Model: LiSP426483SHHTT DC 3.85V, 4380mAh, 16.863Wh
Hardware version	TE855-A2-PCB-V1.0
Software version	A95_EEA_TE855_V1.0
Device Operating Configurations	
Supporting Mode(s)	GSM 900/1800, WCDMA Band 1/8, LTE Band 1/3/7/8/20/40, WLAN 2.4G/5G, Bluetooth, GPS, FM
Test Modulation	GSM(GMSK/8PSK), WCDMA(QPSK), LTE(QPSK/16-QAM), WLAN(DSSS/OFDM), Bluetooth(GFSK, π/4-DQPSK, 8DPSK), GPS(BPSK), FM(FM)
Device Class	B

Operating Frequency Range(s)	Band	Tx (MHz)	Rx (MHz)
	GSM 900	880-915	925-960
	GSM 1800	1710-1785	1805-1880
	WCDMA Band 1	1920-1980	2110-2170
	WCDMA Band 8	880-915	925-960
	LTE Band 1	1920-1980	2110-2170
	LTE Band 3	1710-1785	1805-1880
	LTE Band 7	2500-2570	2620-2690
	LTE Band 8	880- 915	925- 960
	LTE Band 20	832-862	791-821
	LTE Band 40	2300-2400	
	WLAN 2.4G	2412-2472	
	WLAN 5.2G	5180-5240	
	WLAN 5.8G	5745-5825	
	Bluetooth	2402-2480	
FM	N/A	87.5-108	
GPS	N/A	1575.42	
GPRS Multislot Class(12)	Max Number of Timeslots in Uplink	4	
	Max Number of Timeslots in Downlink	4	
	Max Total Timeslot	5	
EGPRS Multislot Class(12)	Max Number of Timeslots in Uplink	4	
	Max Number of Timeslots in Downlink	4	
	Max Total Timeslot	5	
Power Class	4, tested with power level 5(GSM 900)		
	1, tested with power level 0(GSM 1800)		
	3, tested with power control -all 1"(WCDMA Band 1)		
	3, tested with power control -all 1"(WCDMA Band 8)		
	3, tested with power control all Max.(LTE Band 1)		
	3, tested with power control all Max.(LTE Band 3)		
	3, tested with power control all Max.(LTE Band 7)		
	3, tested with power control all Max.(LTE Band 8)		
	3, tested with power control all Max.(LTE Band 20)		
	3, tested with power control all Max.(LTE Band 40)		

1.4. Test specification(s)

EN 50360:2017	Product standard to demonstrate the compliance of wireless communication devices, with the basic restrictions and exposure limit values related to human exposure to electromagnetic fields in the frequency range from 300 MHz to 6 GHz: devices used next to the ear
EN 50566:2017	Product standard to demonstrate the compliance of wireless communication devices with the basic restrictions and exposure limit values related to human exposure to electromagnetic fields in the frequency range from 30 MHz to 6 GHz: hand-held and body mounted devices in close proximity to the human body
EN 62209-1:2016	Measurement procedure for the assessment of specific absorption rate of human exposure to radio frequency fields from hand-held and body-mounted wireless communication devices - Part 1: Devices used next to the ear (Frequency range of 300 MHz to 6 GHz)
EN 62209-2:2010	Human exposure to radio frequency fields from hand-held and body-mounted wireless communication devices – Human models, instrumentation, and procedures –Part 2: Procedure to determine the Specific Absorption Rate (SAR) in the head and body for 30MHz to 6GHz Handheld and Body-Mounted Devices used in close proximity to the body
EN 62479:2010	Assessment of the compliance of low-power electronic and electrical equipment with the restrictions related to human exposure to electromagnetic fields(10 MHz to 300 GHz)

1.5. Ambient Condition

Ambient temperature	20°C – 24°C
Relative Humidity	30% – 70%

2. SAR Measurement System

2.1. SATIMO SAR Measurement Set-up Diagram

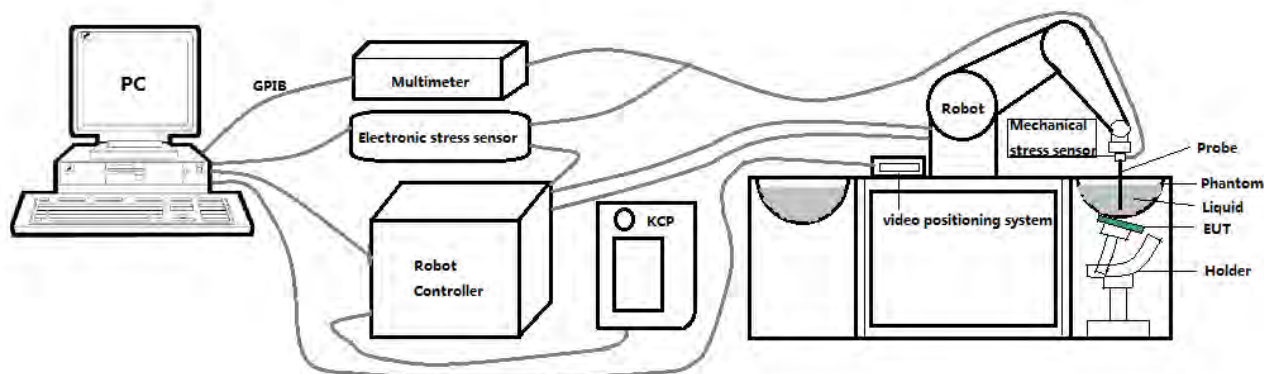

These measurements were performed with the automated near-field scanning system OPENSAR from SATIMO. The system is based on a high precision robot (working range: 901 mm), which positions the probes with a positional repeatability of better than ± 0.03 mm. The SAR measurements were conducted with dosimetric probe (manufactured by SATIMO), designed in the classical triangular configuration and optimized for dosimetric evaluation.

The first step of the field measurement is the evaluation of the voltages induced on the probe by the device under test. Probe diode detectors are nonlinear. Below the diode compression point, the output voltage is proportional to the square of the applied E-field; above the diode compression point, it is linear to the applied E-field. The compression point depends on the diode, and a calibration procedure is necessary for each sensor of the probe.

The Keithley multimeter reads the voltage of each sensor and send these three values to the PC. The corresponding E field value is calculated using the probe calibration factors, which are stored in the working directory. This evaluation includes linearization of the diode characteristics. The field calculation is done separately for each sensor. Each component of the E field is displayed on the "Dipole Area Scan Interface" and the total E field is displayed on the "3D Interface"

2.2. Robot

The SATIMO SAR system uses the high precision robots from KUKA. For the 6-axis controller system, the robot controller version (KUKA) from KUKA is used. The KUKA robot series have many features that are important for our application:



- High precision (repeatability ± 0.03 mm)
- High reliability (industrial design)
- Jerk-free straight movements
- Low ELF interference (the closed metallic construction shields against motor control fields)

2.4. SAM phantoms

Photo of SAM phantom SN 16/15 SAM119



The SAM phantom is used to measure the SAR relative to people exposed to electro-magnetic field radiated by mobile phones.

2.4.1. Technical Data

Serial Number	Shell thickness	Filling volume	Dimensions	Positionner Material	Permittivity	Loss Tangent
SN 16/15 SAM119	2 mm ±0.2 mm	27 liters	Length:1000 mm Width:500 mm Height:200 mm	Gelcoat with fiberglass	3.4	0.02

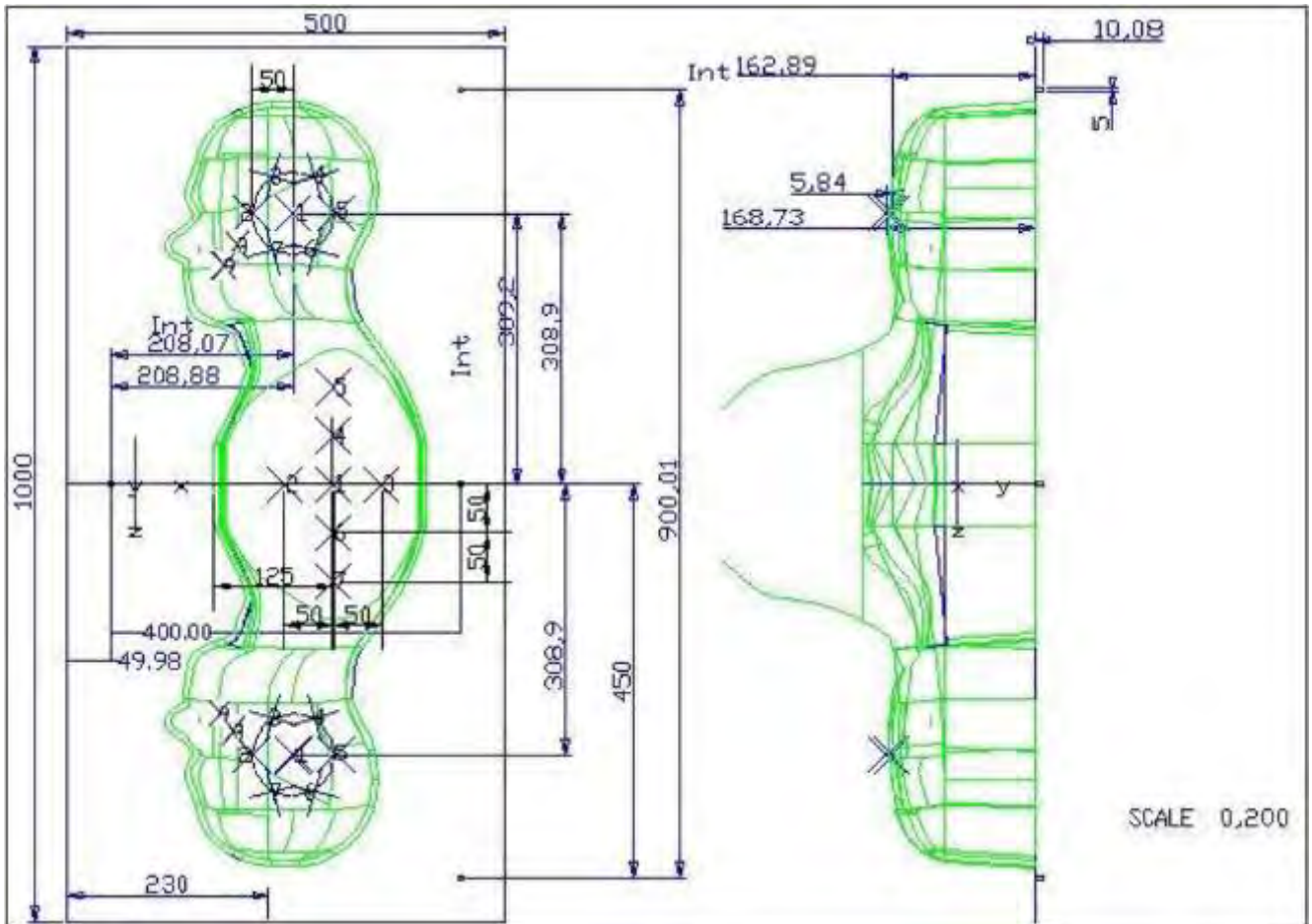

Serial Number	Left Head(mm)		Right Head(mm)		Flat Part(mm)	
	1	2	1	2	1	2
SN 16/15 SAM119	2	2.02	2	2.08	1	2.09
	3	2.05	3	2.06	2	2.06
	4	2.07	4	2.07	3	2.08
	5	2.08	5	2.08	4	2.10
	6	2.05	6	2.07	5	2.10
	7	2.05	7	2.05	6	2.07
	8	2.07	8	2.06	7	2.07
	9	2.08	9	2.06	-	-

The test, based on ultrasonic system, allows measuring the thickness with an accuracy of 10 µm.

2.5. Device Holder

The positioning system allows obtaining cheek and tilting position with a very good accuracy. In compliance with CENELEC, the tilt angle uncertainty is lower than 1 degree.

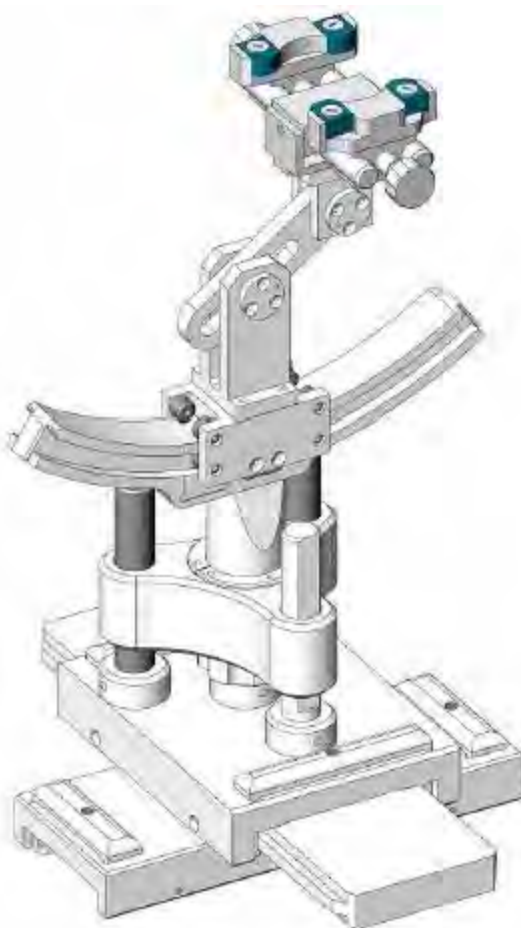

Serial Number	Holder Material	Permittivity	Loss Tangent
SN 16/15 MSH100	Delrin	3.7	0.005

2.6. Test Equipment List

This table gives a complete overview of the SAR measurement equipment.

Devices used during the test described are marked

	Manufacturer	Name of Equipment	Type/Model	Serial Number	Calibration	
					Last Cal.	Due Date
<input checked="" type="checkbox"/>	MVG	E FIELD PROBE	SSE2	SN 08/16 EPGO287	Mar. 01, 2021	Feb. 28, 2022
<input type="checkbox"/>	MVG	750 MHz Dipole	SID750	SN 03/15 DIP 0G750-355	Mar. 01, 2021	Feb. 28, 2024
<input type="checkbox"/>	MVG	835 MHz Dipole	SID835	SN 03/15 DIP 0G835-347	Mar. 01, 2021	Feb. 28, 2024
<input checked="" type="checkbox"/>	MVG	900 MHz Dipole	SID900	SN 03/15 DI P 0G900-348	Mar. 01, 2021	Feb. 28, 2024
<input checked="" type="checkbox"/>	MVG	1800 MHz Dipole	SID1800	SN 03/15 DIP 1G800-349	Mar. 01, 2021	Feb. 28, 2024
<input type="checkbox"/>	MVG	1900 MHz Dipole	SID1900	SN 03/15 DIP 1G900-350	Mar. 01, 2021	Feb. 28, 2024
<input checked="" type="checkbox"/>	MVG	2000 MHz Dipole	SID2000	SN 03/15 DIP 2G000-351	Mar. 01, 2021	Feb. 28, 2024
<input checked="" type="checkbox"/>	MVG	2300 MHz Dipole	SID2300	SN 03/16 DIP 2G300-358	Mar. 01, 2021	Feb. 28, 2024
<input checked="" type="checkbox"/>	MVG	2450 MHz Dipole	SID2450	SN 03/15 DIP 2G450-352	Mar. 01, 2021	Feb. 28, 2024
<input checked="" type="checkbox"/>	MVG	2600 MHz Dipole	SID2600	SN 03/15 DIP 2G600-356	Mar. 01, 2021	Feb. 28, 2024
<input type="checkbox"/>	MVG	5000 MHz Dipole	SWG5500	SN 13/14 WGA 33	Mar. 01, 2021	Feb. 28, 2024
<input checked="" type="checkbox"/>	MVG	Liquid measurement Kit	SCLMP	SN 21/15 OCPG 72	NCR	NCR
<input checked="" type="checkbox"/>	MVG	Power Amplifier	N.A	AMPLISAR_28/14_003	NCR	NCR
<input checked="" type="checkbox"/>	KEITHLEY	Millivoltmeter	2000	4072790	NCR	NCR
<input checked="" type="checkbox"/>	R&S	Universal radio communication tester	CMU200	117858	Jul. 01, 2021	Jun. 30, 2022
<input checked="" type="checkbox"/>	R&S	Wideband radio communication tester	CMW500	103917	Jul. 01, 2021	Jun. 30, 2022
<input checked="" type="checkbox"/>	HP	Network Analyzer	8753D	3410J01136	Jul. 01, 2021	Jun. 30, 2022

<input checked="" type="checkbox"/>	Agilent	PSG Analog Signal Generator	E8257D	MY51110112	Jul. 01, 2021	Jun. 30, 2022
<input checked="" type="checkbox"/>	Agilent	Power meter	E4419B	MY45102538	Jul. 01, 2021	Jun. 30, 2022
<input checked="" type="checkbox"/>	Agilent	Power sensor	E9301A	MY41495644	Jul. 01, 2021	Jun. 30, 2022
<input checked="" type="checkbox"/>	Agilent	Power sensor	E9301A	US39212148	Jul. 01, 2021	Jun. 30, 2022
<input checked="" type="checkbox"/>	MCLI/USA	Directional Coupler	CB11-20	0D2L51502	Jul. 17, 2020	Jul. 16, 2023

3. SAR Measurement Procedures

The measurement procedures are as follows:

- (a) Use base station simulator (if applicable) or engineering software to transmit RF power continuously (continuous Tx) in the middle channel.
- (b) Keep EUT to radiate maximum output power or 100% duty factor (if applicable)
- (c) Measure output power through RF cable and power meter.
- (d) Place the EUT in the positions as setup photos demonstrates.
- (e) Set scan area, grid size and other setting on the OPENSAR software.
- (f) Measure SAR transmitting at the middle channel for all applicable exposure positions.
- (g) Identify the exposure position and device configuration resulting the highest SAR
- (h) Measure SAR at the lowest and highest channels at the worst exposure position and device configuration.

According to the test standard, the recommended procedure for assessing the peak spatial-average SAR value consists of the following steps:

- (a) Power reference measurement
- (b) Area scan
- (c) Zoom scan
- (d) Power drift measurement

3.1. Power Reference

The Power Reference Measurement and Power Drift Measurements are for monitoring the power drift of the device under test in the batch process. The minimum distance of probe sensors to surface determines the closest measurement point to phantom surface. This distance cannot be smaller than the distance of sensor calibration points to probe tip as defined in the probe properties.

3.2. Area scan & Zoom scan

The area scan is a 2D scan to find the hot spot location on the DUT. The zoom scan is a 3D scan above the hot spot to calculate the 1g and 10g SAR value.

Measurement of the SAR distribution with a grid of 8 to 16 mm * 8 to 16 mm and a constant distance to the inner surface of the phantom. Since the sensors cannot directly measure at the inner phantom surface, the values between the sensors and the inner phantom surface are extrapolated. With these values the area of the maximum SAR is calculated by an interpolation scheme. Around this point, a cube of 30 * 30 * 30 mm or 32 * 32 * 32 mm is assessed by measuring 5 or 8 * 5 or 8 * 4 or 5 mm. With these data, the peak spatial-average SAR value can be calculated.

From the scanned SAR distribution, identify the position of the maximum SAR value, in addition identify the positions of any local maxima with SAR values within 2 dB of the maximum value that will not be within the zoom scan of other peaks; additional peaks shall be measured only when the primary peak is within 2 dB of the SAR compliance limit (e.g., 1 W/kg for 1,6 W/kg 1 g limit, or 1,26 W/kg for 2 W/kg, 10 g limit).

3.3. Description of interpolation/extrapolation scheme

The local SAR inside the phantom is measured using small dipole sensing elements inside a probe body. The probe tip must not be in contact with the phantom surface in order to minimise measurements errors, but the highest local SAR will occur at the surface of the phantom.

An extrapolation is used to determine these highest local SAR values. The extrapolation is based on a fourth-order least-square polynomial fit of measured data. The local SAR value is then extrapolated from the liquid surface with a 1 mm step.

The measurements have to be performed over a limited time (due to the duration of the battery) so the step of measurement is high. It could vary between 5 and 8 mm. To obtain an accurate assessment of the maximum SAR averaged over 10 grams and 1 gram requires a very fine resolution in the three dimensional scanned data array.

3.4. Volumetric Scan

The volumetric scan consists of a full 3D scan over a specific area. This 3D scan is useful for multi Tx SAR measurement. Indeed, it is possible with OpenSAR to add, point by point, several volumetric scans to calculate the SAR value of the combined measurement as it is defined in the standard IEEE1528 and IEC62209.

3.5. Power Drift

All SAR testing is under the EUT installed with a full charged battery and transmit maximum output power. In OpenSAR measurement software, the power reference measurement and power drift measurement procedures are used for monitoring the power drift of EUT during SAR test. Both these procedures measure the field at a specified reference position before and after the SAR testing. The software will calculate the field difference in V/m. If the power drifts more than $\pm 5\%$, the SAR will be retested.

4. System Verification Procedure

4.1. Tissue Verification

The following tissue formulations are provided for reference only as some of the parameters have not been thoroughly verified. The composition of ingredients may be modified accordingly to achieve the desired target tissue parameters required for routine SAR evaluation.

Ingredients (% of weight)	Head Tissue								
	750	835	900	1800	1900	2000	2450	2600	5000
Frequency Band (MHz)	750	835	900	1800	1900	2000	2450	2600	5000
Water	34.40	34.40	34.40	55.36	55.36	71.88	71.88	71.88	65.53
NaCl	0.79	0.79	0.79	0.35	0.35	0.16	0.16	0.16	0.00
1,2-Propanediol	64.81	64.81	64.81	0.00	0.00	0.00	0.00	0.00	0.00
Triton X-100	0.00	0.00	0.00	30.45	30.45	19.97	19.97	19.97	17.24
DGBE	0.00	0.00	0.00	13.84	13.84	7.99	7.99	7.99	0.00

For SAR measurement of the field distribution inside the phantom, the phantom must be filled with homogeneous tissue simulating liquid to a depth of at least 15 cm. For head SAR testing, the liquid depth from the ear reference point (ERP) of the phantom to the liquid top surface is larger than 15 cm.

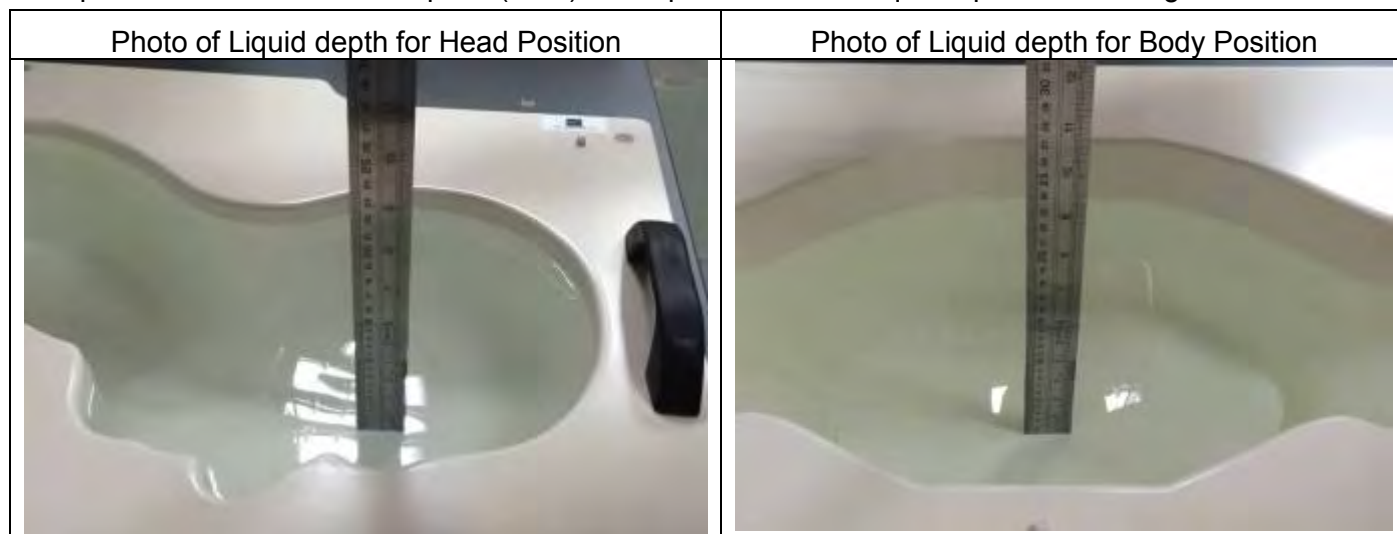

4.1.1. Tissue Dielectric Parameter Check Results

The simulating liquids should be checked at the beginning of a series of SAR measurements to determine if the dielectric parameters are within the tolerances of the specified target values. The measured conductivity and relative permittivity should be within $\pm 5\%$ of the target values.

Tissue Type	Measured Frequency (MHz)	Target Tissue		Measured Tissue		Liquid Temp.	Test Date
		$\epsilon_r (\pm 5\%)$	σ (S/m) ($\pm 5\%$)	ϵ_r	σ (S/m)		
Head 900	900	41.50 (39.43~43.58)	0.97 (0.92~1.02)	42.11	1.00	21.8 °C	Nov. 29, 2021
Head 1800	1800	40.00 (38.00~42.00)	1.40 (1.33~1.47)	39.14	1.40	21.8 °C	Nov. 26, 2021
Head 2000	2000	40.00 (38.00~42.00)	1.40 (1.33~1.47)	41.51	1.40	21.7 °C	Nov. 22, 2021
Head 2300	2300	39.47 (37.50~41.44)	1.66 (1.58~1.74)	39.71	1.69	21.9 °C	Dec. 03, 2021
Head 2450	2450	39.20 (37.24~41.16)	1.80 (1.71~1.89)	40.51	1.79	21.5 °C	Nov. 27, 2021
Head 2600	2600	39.01 (37.06~40.96)	1.96 (1.86~2.06)	39.37	1.97	21.4 °C	Dec. 06, 2021

NOTE: The dielectric parameters of the tissue-equivalent liquid should be measured under similar ambient conditions and within 2 °C of the conditions expected during the SAR evaluation to satisfy protocol requirements.

4.2. System Verification Procedure

The system verification is performed for verifying the accuracy of the complete measurement system and performance of the software. The dipole is connected to the signal source consisting of signal generator and amplifier via a directional coupler, N-connector cable and adaption to SMA. It is fed with a power of 100mW (below 5GHz) or 100mW (above 5GHz). To adjust this power a power meter is used. The power sensor is connected to the cable before the system verification to measure the power at this point and do adjustments at the signal generator. At the outputs of the directional coupler both return loss as well as forward power are controlled during the system verification to make sure that emitted power at the dipole is kept constant. This can also be checked by the power drift measurement after the test (result on plot).

The system verification is shown as below picture:

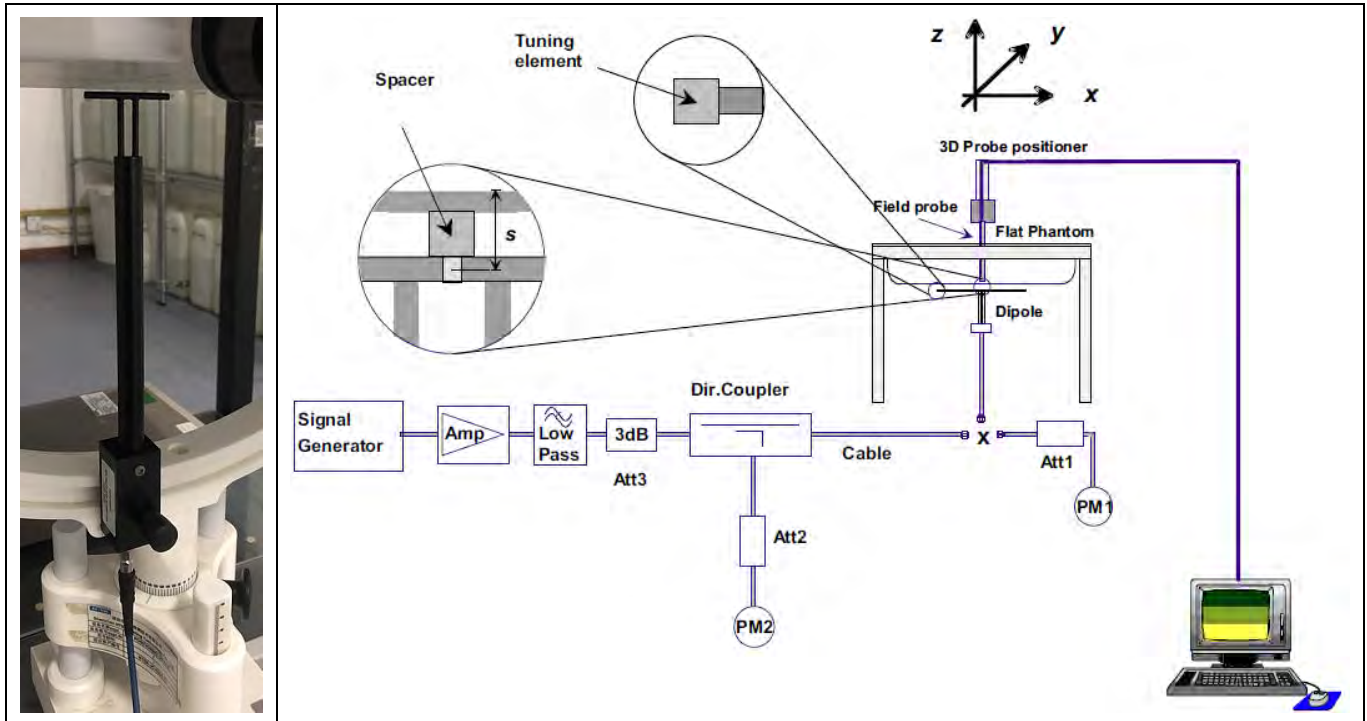

4.2.1. System Verification Results

Comparing to the original SAR value provided by SATIMO, the verification data should be within its specification of $\pm 10\%$. Below table shows the target SAR and measured SAR after normalized to 1W input power. The table below indicates the system performance verification can meet the variation criterion and the plots can be referred to Appendix B of this report.

System Verification	Target SAR (1W) ($\pm 10\%$)		Measured SAR (Normalized to 1W)		Liquid Temp.	Test Date
	1-g (W/Kg)	10-g (W/Kg)	1-g (W/Kg)	10-g (W/Kg)		
900MHz	11.08 (9.98~12.18)	6.81 (6.13~7.49)	11.09	7.09	21.8 °C	Nov. 29, 2021
1800MHz	37.96 (34.17~41.75)	19.81 (17.83~21.79)	36.26	19.91	21.8 °C	Nov. 26, 2021
2000MHz	41.26 (37.14~45.38)	20.52 (18.47~22.57)	41.33	21.72	21.7 °C	Nov. 22, 2021
2300MHz	50.65 (45.59~55.71)	23.55 (21.20~25.90)	52.16	25.30	21.9 °C	Dec. 03, 2021
2450MHz	53.69 (48.33~59.05)	23.94 (21.55~26.33)	57.30	24.91	21.5 °C	Nov. 27, 2021
2600MHz	55.83 (50.25~61.41)	24.19 (21.78~26.60)	52.92	25.67	21.4 °C	Dec. 06, 2021

5. SAR Measurement Uncertainty

The following measurement uncertainty levels have been estimated for tests performed on the EUT as specified in IEEE 1528: 2003. This uncertainty represents an expanded uncertainty expressed at approximately the 95% confidence level using a coverage factor of k=2.

Uncertainty Component	Tol. (±%)	Prob. Dist.	Div.	Ci (1 g)	Ci (10 g)	1 g Ui (±%)	10 g Ui (±%)	Vi
Measurement System □								
Probe Calibration	5.8	N	1	1	1	5.80	5.80	∞
Axial Isotropy	3.5	R	√3	0.7	0.7	1.43	1.43	∞
Hemispherical Isotropy	5.9	R	√3	0.7	0.7	2.41	2.41	∞
Boundary Effect	1	R	√3	1	1	0.58	0.58	∞
Linearity	4.7	R	√3	1	1	2.71	2.71	∞
System Detection Limits	1	R	√3	1	1	0.58	0.58	∞
Modulation response	3	N	1	1	1	3.00	3.00	∞
Readout Electronics	0.5	N	1	1	1	0.50	0.50	∞
Response Time	0	R	√3	1	1	0.00	0.00	∞
Integration Time	1.4	R	√3	1	1	0.81	0.81	∞
RF Ambient Conditions - Noise	3	R	√3	1	1	1.73	1.73	∞
RF Ambient Conditions - Reflections	3	R	√3	1	1	1.73	1.73	∞
Probe Positioner Mechanical Tolerance	1.4	R	√3	1	1	0.81	0.81	∞
Probe Positioning with respect to Phantom Shell	1.4	R	√3	1	1	0.81	0.81	∞
Extrapolation, interpolation and Integration Algorithms for Max. SAR Evaluation	2.3	R	√3	1	1	1.33	1.33	∞
Test sample Related								
Test Sample Positioning	2.6	N	1	1	1	2.60	2.60	11
Device Holder Uncertainty	3	N	1	1	1	3.00	3.00	7
Output Power Variation - SAR drift measurement	5	R	√3	1	1	2.89	2.89	∞
SAR scaling	2	R	√3	1	1	1.15	1.15	∞
Phantom and Tissue Parameters □								
Phantom Uncertainty (shape and thickness tolerances)	4	R	√3	1	1	2.31	2.31	∞
Uncertainty in SAR correction for deviation (in permittivity and conductivity)	2	N	1	1	0.84	2.00	1.68	∞
Liquid Conductivity (temperature uncertainty)	2.5	N	1	0.78	0.71	1.95	1.78	5
Liquid conductivity - measurement uncertainty	4	N	1	0.23	0.26	0.92	1.04	5
Liquid permittivity (temperature uncertainty)	2.5	N	1	0.78	0.71	1.95	1.78	∞
Liquid permittivity - measurement uncertainty	5	N	1	0.23	0.26	1.15	1.30	∞
Combined Standard Uncertainty		RSS				10.63	10.54	
Expanded Uncertainty (95% Confidence interval)		k				21.26	21.08	

6. RF Exposure Positions

6.1. Ear and handset reference point

Figure 6.1.1 shows the front, back, and side views of the SAM phantom. The center-of-mouth reference point is labeled "M", the left ear reference point (ERP) is marked "LE", and the right ERP is marked "RE".



Fig 6.1.1 Front, back, and side views of SAM phantom

6.2. Definition of the cheek position

1. Define two imaginary lines on the handset, the vertical centerline and the horizontal line. The vertical centerline passes through two points on the front side of the handset: the midpoint of the width w_t of the handset at the level of the acoustic output (point A in Figure 6.2.1 and Figure 6.2.2), and the midpoint of the width w_b of the bottom of the handset (point B). The horizontal line is perpendicular to the vertical centerline and passes through the center of the acoustic output (see Figure 6.2.1). The two lines intersect at point A. Note that for many handsets, point A coincides with the center of the acoustic output; however, the acoustic output may be located elsewhere on the horizontal line. Also note that the vertical centerline is not necessarily parallel to the front face of the handset (see Figure 6.2.2), especially for clamshell handsets, handsets with flip covers, and other irregularly-shaped handsets.
2. Position the handset close to the surface of the phantom such that point A is on the (virtual) extension of the line passing through points RE and LE on the phantom (see Figure 6.2.3), such that the plane defined by the vertical centerline and the horizontal line of the handset is approximately parallel to the sagittal plane of the phantom.
3. Translate the handset towards the phantom along the line passing through RE and LE until handset point A touches the pinna at the ERP
4. While maintaining the handset in this plane, rotate it around the LE-RE line until the vertical centerline is in the plane normal to the plane containing B-M and N-F lines, i.e., the Reference Plane.
5. Rotate the handset around the vertical centerline until the handset (horizontal line) is parallel to the N-F line.

6. While maintaining the vertical centerline in the Reference Plane, keeping point A on the line passing through RE and LE, and maintaining the handset contact with the pinna, rotate the handset about the N-F line until any point on the handset is in contact with a phantom point below the pinna on the cheek. See Figure 6.2.3. The actual rotation angles should be documented in the test report.

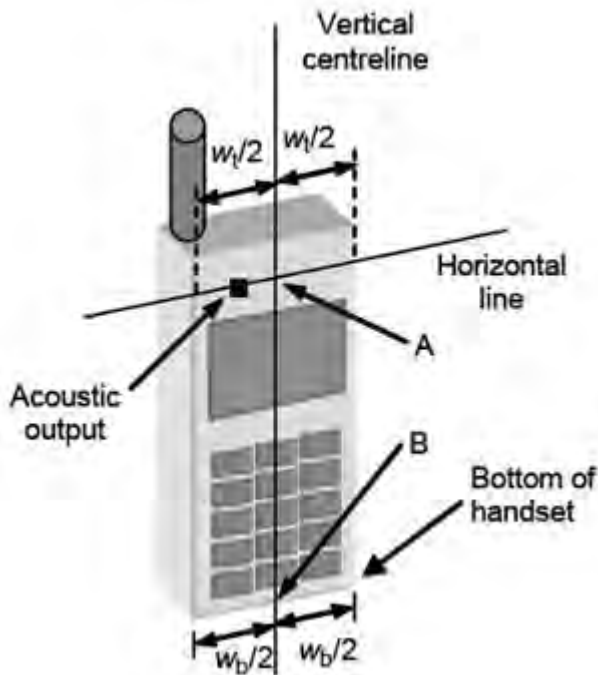

Fig 6.2.1 Handset vertical and horizontal reference lines—fixed case

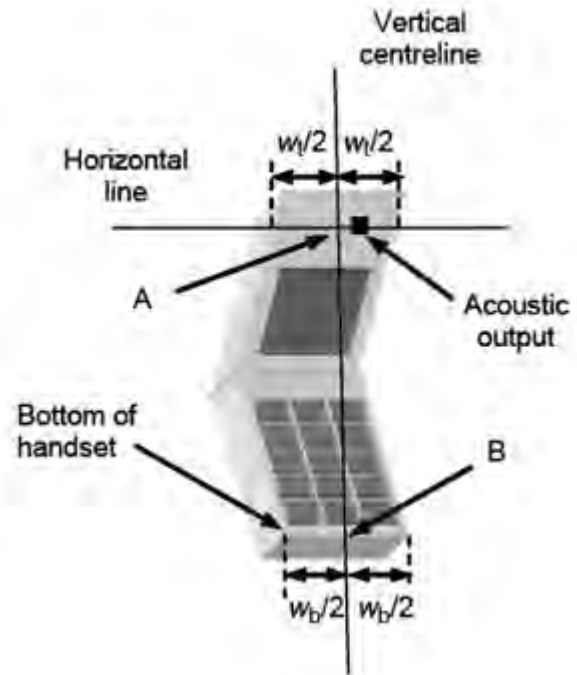

Fig 6.2.2 Handset vertical and horizontal reference lines—“clam-shell case”

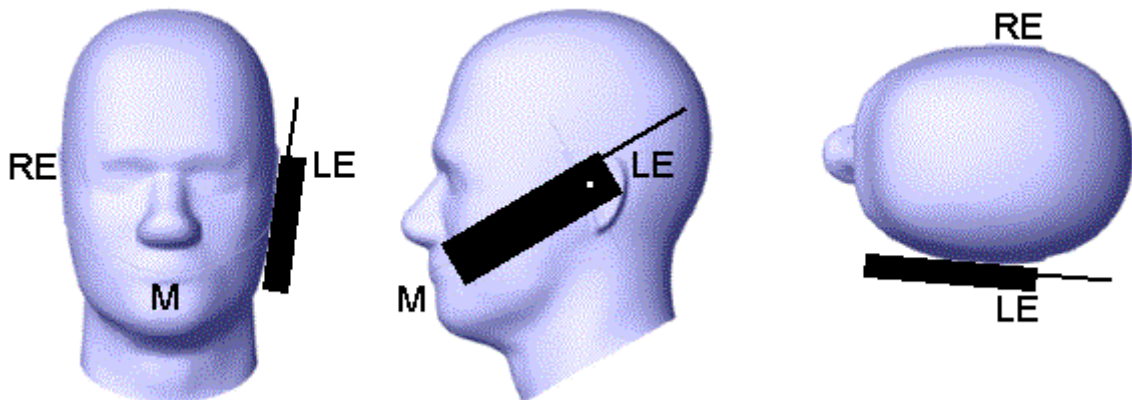

Fig 6.2.3 cheek or touch position. The reference points for the right ear (RE), left ear (LE), and mouth (M), which establish the Reference Plane for handset positioning, are indicated.

6.3. Definition of the tilt position

1. While maintaining the orientation of the handset, retract the handset parallel to the reference plane far enough away from the phantom to enable a rotation of the device by 15 degree.
2. Rotate the Handset around the horizontal line by 15 degree (see Figure 6.3.1).
3. While maintaining the orientation of the handset, move the handset towards the phantom on a line passing through RE and LE until any part of the handset touches the ear. The tilt position is obtained when the contact is on the pinna. If the contact is at any location other than the pinna, e.g., the antenna with the back of the phantom head, the angle of the handset shall be reduced. In this case, the tilt position is obtained if any part of the handset is in contact with the pinna as well as a second part of the handset is in contact with the phantom, e.g., the antenna with the back of the head.

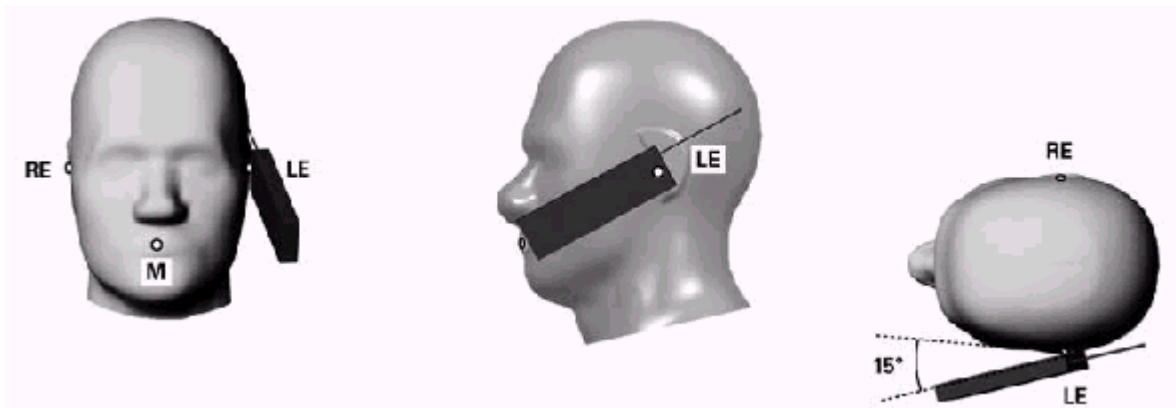

Figure 6.3.1 – Tilt position of the wireless device on the left side of SAM

6.4. Body-worn device

A typical example of a body-worn device is a mobile phone, wireless enabled PDA or other battery operated wireless device with the ability to transmit while mounted on a person's body using a carry accessory approved by the wireless device manufacturer. The device shall be positioned as intended at the distance to the outer surface of the phantom that corresponds to the specified distance (See figure 6.1). Adjust the distance between the device surface and the flat phantom to 5mm.

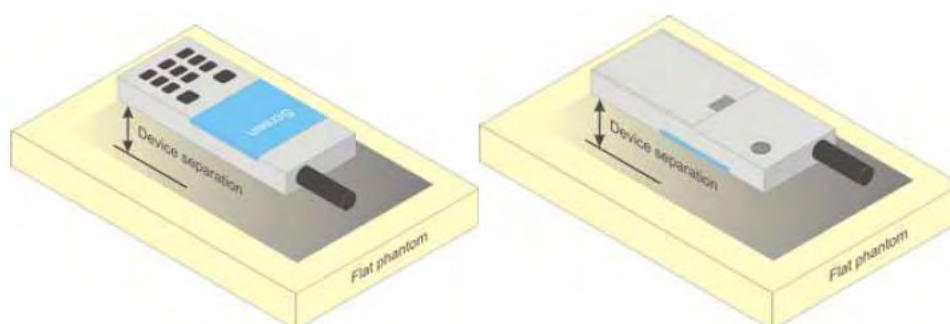

Figure 6.1 – Test positions for Body-worn device

7. RF Output Power

7.1. GSM Conducted Power

Band GSM900	Burst-Averaged output Power (dBm)				Frame-Averaged output Power (dBm)			
	Tune -	975	38	124	Tune -	975	38	124
Tx Channel	up	880.2	897.6	914.8	up	880.2	897.6	914.8
Frequency (MHz)								
GSM Voice(GMSK)	33.00	32.89	32.83	32.62	23.97	23.86	23.80	23.59
GPRS(GMSK, 1 TS)	33.00	32.88	32.81	32.59	23.97	23.85	23.78	23.56
GPRS(GMSK, 2 TS)	32.50	32.27	32.18	31.95	26.48	26.25	26.16	25.93
GPRS(GMSK, 3 TS)	31.00	30.71	30.65	30.37	26.74	26.45	26.39	26.11
GPRS(GMSK, 4 TS)	29.50	29.49	29.43	29.16	26.49	26.48	26.42	26.15
EGPRS(8PSK, 1 TS)	26.50	26.05	26.03	25.96	17.47	17.02	17.00	16.93
EGPRS(8PSK, 2 TS)	26.00	25.61	25.53	25.51	19.98	19.59	19.51	19.49
EGPRS(8PSK, 3 TS)	23.50	23.06	23.00	23.01	19.24	18.80	18.74	18.75
EGPRS(8PSK, 4 TS)	22.00	21.73	21.76	21.74	18.99	18.72	18.75	18.73
Band GSM1800	Burst-Averaged output Power (dBm)				Frame-Averaged output Power (dBm)			
	Tune -	512	698	885	Tune -	512	698	885
Tx Channel	up	1710.2	1747.4	1784.8	up	1710.2	1747.4	1784.8
Frequency (MHz)								
GSM Voice(GMSK)	31.00	30.25	30.38	30.65	21.97	21.22	21.35	21.62
GPRS(GMSK, 1 TS)	31.00	30.29	30.38	30.67	21.97	21.26	21.35	21.64
GPRS(GMSK, 2 TS)	30.50	29.75	29.79	30.06	24.48	23.73	23.77	24.04
GPRS(GMSK, 3 TS)	28.50	28.04	28.08	28.25	24.24	23.78	23.82	23.99
GPRS(GMSK, 4 TS)	27.50	26.97	27.01	27.24	24.49	23.96	24.00	24.23
EGPRS(8PSK, 1 TS)	26.00	25.93	25.99	25.41	16.97	16.90	16.96	16.38
EGPRS(8PSK, 2 TS)	26.00	25.45	25.53	24.99	19.98	19.43	19.51	18.97
EGPRS(8PSK, 3 TS)	25.00	24.59	24.66	24.15	20.74	20.33	20.40	19.89
EGPRS(8PSK, 4 TS)	24.50	24.01	24.06	23.57	21.49	21.00	21.05	20.56

Note: The frame-averaged power is linearly scaled the maximum burst averaged power over 8 time slots. The calculated method are shown as below:

Frame-averaged power = Maximum burst averaged power (1 Tx Slot) - 9.03 dB

Frame-averaged power = Maximum burst averaged power (2 Tx Slots) - 6.02 dB

Frame-averaged power = Maximum burst averaged power (3 Tx Slots) - 4.26 dB

Frame-averaged power = Maximum burst averaged power (4 Tx Slots) - 3.01 dB

7.2. WCDMA Conducted Power

Band		WCDMA Band 1		
Tx Channel	Tune - up	9612	9750	9888
Frequency (MHz)		1922.4	1950	1977.6
RMC 12.2Kbps	23.50	22.87	23.04	23.30
HSDPA Sub 1	22.50	21.91	22.10	22.34
HSDPA Sub 2	22.00	21.38	21.55	21.97
HSDPA Sub 3	21.00	20.03	20.35	20.62
HSDPA Sub 4	21.00	20.50	20.28	20.93
HSUPA Sub 1	22.50	21.66	21.89	22.20
HSUPA Sub 2	22.50	21.71	22.01	22.27
HSUPA Sub 3	21.50	20.64	20.86	21.12
HSUPA Sub 4	22.50	21.88	22.11	22.36
HSUPA Sub 5	22.00	21.23	21.44	21.82
Band		WCDMA Band 8		
Tx Channel	Tune - up	2712	2788	2863
Frequency (MHz)		882.4	897.6	912.6
RMC 12.2Kbps	23.00	22.74	22.69	22.61
HSDPA Sub 1	22.00	21.81	21.75	21.70
HSDPA Sub 2	21.50	21.31	21.33	21.16
HSDPA Sub 3	20.50	20.41	20.40	20.07
HSDPA Sub 4	21.00	20.50	20.07	20.19
HSUPA Sub 1	22.00	20.62	21.55	21.38
HSUPA Sub 2	22.00	21.70	21.64	21.62
HSUPA Sub 3	21.00	20.11	20.70	20.44
HSUPA Sub 4	22.00	21.81	21.73	21.69
HSUPA Sub 5	21.50	20.43	21.03	20.98

7.3. LTE Conducted Power

Band	Bandwidth (MHz)	UL Channel	RB Size	RB Position	Modulation	Tune-up	Power (dBm)
Band1	5	18025	1	#0	QPSK	24.50	24.02
Band1	5	18025	8	#0	QPSK	24.50	24.07
Band1	5	18025	25	#0	QPSK	24.50	23.13
Band1	5	18025	1	#0	QAM16	24.50	23.24
Band1	5	18025	8	#0	QAM16	24.50	23.09
Band1	5	18025	25	#0	QAM16	24.50	22.09
Band1	5	18300	1	#0	QPSK	24.50	24.17

Band1	5	18300	8	#0	QPSK	24.50	24.24
Band1	5	18300	25	#0	QPSK	24.50	23.34
Band1	5	18300	1	#0	QAM16	24.50	23.47
Band1	5	18300	8	#0	QAM16	24.50	23.26
Band1	5	18300	25	#0	QAM16	24.50	22.33
Band1	5	18575	1	#0	QPSK	24.50	24.40
Band1	5	18575	8	#0	QPSK	24.50	24.50
Band1	5	18575	25	#0	QPSK	24.50	23.56
Band1	5	18575	1	#0	QAM16	24.50	23.71
Band1	5	18575	8	#0	QAM16	24.50	23.55
Band1	5	18575	25	#0	QAM16	24.50	22.56
Band1	20	18100	1	#0	QPSK	24.50	24.05
Band1	20	18100	18	#0	QPSK	24.50	24.05
Band1	20	18100	100	#0	QPSK	24.50	23.14
Band1	20	18100	1	#0	QAM16	24.50	23.25
Band1	20	18100	18	#0	QAM16	24.50	23.03
Band1	20	18100	100	#0	QAM16	24.50	22.09
Band1	20	18300	1	#0	QPSK	24.50	24.27
Band1	20	18300	18	#0	QPSK	24.50	24.21
Band1	20	18300	100	#0	QPSK	24.50	23.32
Band1	20	18300	1	#0	QAM16	24.50	23.10
Band1	20	18300	18	#0	QAM16	24.50	23.18
Band1	20	18300	100	#0	QAM16	24.50	22.31
Band1	20	18500	1	#0	QPSK	24.50	24.22
Band1	20	18500	18	#0	QPSK	24.50	24.26
Band1	20	18500	100	#0	QPSK	24.50	23.41
Band1	20	18500	1	#0	QAM16	24.50	23.06
Band1	20	18500	18	#0	QAM16	24.50	23.26
Band1	20	18500	100	#0	QAM16	24.50	22.37
Band20	5	24175	1	#0	QPSK	24.00	23.83
Band20	5	24175	8	#0	QPSK	24.00	23.84
Band20	5	24175	25	#0	QPSK	24.00	22.84
Band20	5	24175	1	#0	QAM16	24.00	23.08
Band20	5	24175	8	#0	QAM16	24.00	22.84
Band20	5	24175	25	#0	QAM16	24.00	21.96
Band20	5	24300	1	#0	QPSK	24.00	23.67
Band20	5	24300	8	#0	QPSK	24.00	23.68
Band20	5	24300	25	#0	QPSK	24.00	22.79
Band20	5	24300	1	#0	QAM16	24.00	22.93

Band20	5	24300	8	#0	QAM16	24.00	22.70
Band20	5	24300	25	#0	QAM16	24.00	21.83
Band20	5	24425	1	#0	QPSK	24.00	23.60
Band20	5	24425	8	#0	QPSK	24.00	23.73
Band20	5	24425	25	#0	QPSK	24.00	22.87
Band20	5	24425	1	#0	QAM16	24.00	22.92
Band20	5	24425	8	#0	QAM16	24.00	22.79
Band20	5	24425	25	#0	QAM16	24.00	21.91
Band20	20	24250	1	#0	QPSK	24.00	23.75
Band20	20	24250	18	#0	QPSK	24.00	23.76
Band20	20	24250	100	#0	QPSK	24.00	22.95
Band20	20	24250	1	#0	QAM16	24.00	22.97
Band20	20	24250	18	#0	QAM16	24.00	22.77
Band20	20	24250	100	#0	QAM16	24.00	22.03
Band20	20	24300	1	#0	QPSK	24.00	23.84
Band20	20	24300	18	#0	QPSK	24.00	23.83
Band20	20	24300	100	#0	QPSK	24.00	22.80
Band20	20	24300	1	#0	QAM16	24.00	22.65
Band20	20	24300	18	#0	QAM16	24.00	22.79
Band20	20	24300	100	#0	QAM16	24.00	21.88
Band20	20	24350	1	#0	QPSK	24.00	23.71
Band20	20	24350	18	#0	QPSK	24.00	23.73
Band20	20	24350	100	#0	QPSK	24.00	22.57
Band20	20	24350	1	#0	QAM16	24.00	22.49
Band20	20	24350	18	#0	QAM16	24.00	22.72
Band20	20	24350	100	#0	QAM16	24.00	21.64
Band3	1.4	19207	1	#0	QPSK	24.50	24.04
Band3	1.4	19207	5	#0	QPSK	24.50	23.99
Band3	1.4	19207	6	#0	QPSK	24.50	23.01
Band3	1.4	19207	1	#0	QAM16	24.50	22.98
Band3	1.4	19207	5	#0	QAM16	24.50	23.16
Band3	1.4	19207	6	#0	QAM16	24.50	22.00
Band3	1.4	19575	1	#0	QPSK	24.50	23.89
Band3	1.4	19575	5	#0	QPSK	24.50	23.96
Band3	1.4	19575	6	#0	QPSK	24.50	22.95
Band3	1.4	19575	1	#0	QAM16	24.50	23.09
Band3	1.4	19575	5	#0	QAM16	24.50	23.19
Band3	1.4	19575	6	#0	QAM16	24.50	21.94
Band3	1.4	19943	1	#0	QPSK	24.50	24.13

Band3	1.4	19943	5	#0	QPSK	24.50	24.12
Band3	1.4	19943	6	#0	QPSK	24.50	23.15
Band3	1.4	19943	1	#0	QAM16	24.50	22.98
Band3	1.4	19943	5	#0	QAM16	24.50	23.18
Band3	1.4	19943	6	#0	QAM16	24.50	22.09
Band3	5	19225	1	#0	QPSK	24.50	23.97
Band3	5	19225	8	#0	QPSK	24.50	24.02
Band3	5	19225	25	#0	QPSK	24.50	23.07
Band3	5	19225	1	#0	QAM16	24.50	23.27
Band3	5	19225	8	#0	QAM16	24.50	23.04
Band3	5	19225	25	#0	QAM16	24.50	22.11
Band3	5	19575	1	#0	QPSK	24.50	23.96
Band3	5	19575	8	#0	QPSK	24.50	24.05
Band3	5	19575	25	#0	QPSK	24.50	23.07
Band3	5	19575	1	#0	QAM16	24.50	23.19
Band3	5	19575	8	#0	QAM16	24.50	23.02
Band3	5	19575	25	#0	QAM16	24.50	22.06
Band3	5	19925	1	#0	QPSK	24.50	24.00
Band3	5	19925	8	#0	QPSK	24.50	24.15
Band3	5	19925	25	#0	QPSK	24.50	23.18
Band3	5	19925	1	#0	QAM16	24.50	23.25
Band3	5	19925	8	#0	QAM16	24.50	23.14
Band3	5	19925	25	#0	QAM16	24.50	22.17
Band3	20	19300	1	#0	QPSK	24.50	23.94
Band3	20	19300	18	#0	QPSK	24.50	23.99
Band3	20	19300	100	#0	QPSK	24.50	22.94
Band3	20	19300	1	#0	QAM16	24.50	23.13
Band3	20	19300	18	#0	QAM16	24.50	22.93
Band3	20	19300	100	#0	QAM16	24.50	22.03
Band3	20	19575	1	#0	QPSK	24.50	24.00
Band3	20	19575	18	#0	QPSK	24.50	23.94
Band3	20	19575	100	#0	QPSK	24.50	23.08
Band3	20	19575	1	#0	QAM16	24.50	22.82
Band3	20	19575	18	#0	QAM16	24.50	22.92
Band3	20	19575	100	#0	QAM16	24.50	22.13
Band3	20	19850	1	#0	QPSK	24.50	24.06
Band3	20	19850	18	#0	QPSK	24.50	24.02
Band3	20	19850	100	#0	QPSK	24.50	23.00
Band3	20	19850	1	#0	QAM16	24.50	22.73

Band3	20	19850	18	#0	QAM16	24.50	22.99
Band3	20	19850	100	#0	QAM16	24.50	22.09
Band40	5	38675	1	#0	QPSK	23.00	22.87
Band40	5	38675	8	#0	QPSK	23.00	22.90
Band40	5	38675	25	#0	QPSK	23.00	21.92
Band40	5	38675	1	#0	QAM16	23.00	22.29
Band40	5	38675	8	#0	QAM16	23.00	21.94
Band40	5	38675	25	#0	QAM16	23.00	20.99
Band40	5	39150	1	#0	QPSK	23.00	22.73
Band40	5	39150	8	#0	QPSK	23.00	22.71
Band40	5	39150	25	#0	QPSK	23.00	21.82
Band40	5	39150	1	#0	QAM16	23.00	21.98
Band40	5	39150	8	#0	QAM16	23.00	21.74
Band40	5	39150	25	#0	QAM16	23.00	20.81
Band40	5	39625	1	#0	QPSK	23.00	22.50
Band40	5	39625	8	#0	QPSK	23.00	22.55
Band40	5	39625	25	#0	QPSK	23.00	21.60
Band40	5	39625	1	#0	QAM16	23.00	21.86
Band40	5	39625	8	#0	QAM16	23.00	21.60
Band40	5	39625	25	#0	QAM16	23.00	20.65
Band40	20	38750	1	#0	QPSK	23.00	22.85
Band40	20	38750	18	#0	QPSK	23.00	22.87
Band40	20	38750	100	#0	QPSK	23.00	21.92
Band40	20	38750	1	#0	QAM16	23.00	22.09
Band40	20	38750	18	#0	QAM16	23.00	21.88
Band40	20	38750	100	#0	QAM16	23.00	20.92
Band40	20	39150	1	#0	QPSK	23.00	22.73
Band40	20	39150	18	#0	QPSK	23.00	22.76
Band40	20	39150	100	#0	QPSK	23.00	21.82
Band40	20	39150	1	#0	QAM16	23.00	21.73
Band40	20	39150	18	#0	QAM16	23.00	21.71
Band40	20	39150	100	#0	QAM16	23.00	20.82
Band40	20	39550	1	#0	QPSK	23.00	22.62
Band40	20	39550	18	#0	QPSK	23.00	22.65
Band40	20	39550	100	#0	QPSK	23.00	21.67
Band40	20	39550	1	#0	QAM16	23.00	21.31
Band40	20	39550	18	#0	QAM16	23.00	21.66
Band40	20	39550	100	#0	QAM16	23.00	20.68
Band7	5	20775	1	#0	QPSK	25.50	24.77

Band7	5	20775	8	#0	QPSK	25.50	24.90
Band7	5	20775	25	#0	QPSK	25.50	23.96
Band7	5	20775	1	#0	QAM16	25.50	24.05
Band7	5	20775	8	#0	QAM16	25.50	23.94
Band7	5	20775	25	#0	QAM16	25.50	23.02
Band7	5	21100	1	#0	QPSK	25.50	24.88
Band7	5	21100	8	#0	QPSK	25.50	25.01
Band7	5	21100	25	#0	QPSK	25.50	23.99
Band7	5	21100	1	#0	QAM16	25.50	24.00
Band7	5	21100	8	#0	QAM16	25.50	23.94
Band7	5	21100	25	#0	QAM16	25.50	23.00
Band7	5	21425	1	#0	QPSK	25.50	24.59
Band7	5	21425	8	#0	QPSK	25.50	24.71
Band7	5	21425	25	#0	QPSK	25.50	23.72
Band7	5	21425	1	#0	QAM16	25.50	23.82
Band7	5	21425	8	#0	QAM16	25.50	23.69
Band7	5	21425	25	#0	QAM16	25.50	22.77
Band7	20	20850	1	#0	QPSK	25.50	24.79
Band7	20	20850	18	#0	QPSK	25.50	24.84
Band7	20	20850	100	#0	QPSK	25.50	24.04
Band7	20	20850	1	#0	QAM16	25.50	23.97
Band7	20	20850	18	#0	QAM16	25.50	23.88
Band7	20	20850	100	#0	QAM16	25.50	23.10
Band7	20	21100	1	#0	QPSK	25.50	24.95
Band7	20	21100	18	#0	QPSK	25.50	24.90
Band7	20	21100	100	#0	QPSK	25.50	23.94
Band7	20	21100	1	#0	QAM16	25.50	23.70
Band7	20	21100	18	#0	QAM16	25.50	23.86
Band7	20	21100	100	#0	QAM16	25.50	23.02
Band7	20	21350	1	#0	QPSK	25.50	24.74
Band7	20	21350	18	#0	QPSK	25.50	24.79
Band7	20	21350	100	#0	QPSK	25.50	23.74
Band7	20	21350	1	#0	QAM16	25.50	23.53
Band7	20	21350	18	#0	QAM16	25.50	23.77
Band7	20	21350	100	#0	QAM16	25.50	22.80
Band8	1.4	21457	1	#0	QPSK	24.00	23.66
Band8	1.4	21457	5	#0	QPSK	24.00	23.70
Band8	1.4	21457	6	#0	QPSK	24.00	22.66
Band8	1.4	21457	1	#0	QAM16	24.00	22.64

Band8	1.4	21457	5	#0	QAM16	24.00	22.85
Band8	1.4	21457	6	#0	QAM16	24.00	21.79
Band8	1.4	21625	1	#0	QPSK	24.00	23.54
Band8	1.4	21625	5	#0	QPSK	24.00	23.53
Band8	1.4	21625	6	#0	QPSK	24.00	22.53
Band8	1.4	21625	1	#0	QAM16	24.00	22.68
Band8	1.4	21625	5	#0	QAM16	24.00	22.82
Band8	1.4	21625	6	#0	QAM16	24.00	21.57
Band8	1.4	21793	1	#0	QPSK	24.00	23.45
Band8	1.4	21793	5	#0	QPSK	24.00	23.45
Band8	1.4	21793	6	#0	QPSK	24.00	22.45
Band8	1.4	21793	1	#0	QAM16	24.00	22.31
Band8	1.4	21793	5	#0	QAM16	24.00	22.50
Band8	1.4	21793	6	#0	QAM16	24.00	21.45
Band8	5	21475	1	#0	QPSK	24.00	23.61
Band8	5	21475	8	#0	QPSK	24.00	23.66
Band8	5	21475	25	#0	QPSK	24.00	22.70
Band8	5	21475	1	#0	QAM16	24.00	22.90
Band8	5	21475	8	#0	QAM16	24.00	22.66
Band8	5	21475	25	#0	QAM16	24.00	21.78
Band8	5	21625	1	#0	QPSK	24.00	23.45
Band8	5	21625	8	#0	QPSK	24.00	23.50
Band8	5	21625	25	#0	QPSK	24.00	22.63
Band8	5	21625	1	#0	QAM16	24.00	22.68
Band8	5	21625	8	#0	QAM16	24.00	22.54
Band8	5	21625	25	#0	QAM16	24.00	21.62
Band8	5	21775	1	#0	QPSK	24.00	23.39
Band8	5	21775	8	#0	QPSK	24.00	23.48
Band8	5	21775	25	#0	QPSK	24.00	22.55
Band8	5	21775	1	#0	QAM16	24.00	22.71
Band8	5	21775	8	#0	QAM16	24.00	22.52
Band8	5	21775	25	#0	QAM16	24.00	21.57
Band8	10	21500	1	#0	QPSK	24.00	23.63
Band8	10	21500	12	#0	QPSK	24.00	23.63
Band8	10	21500	50	#0	QPSK	24.00	22.58
Band8	10	21500	1	#0	QAM16	24.00	22.91
Band8	10	21500	12	#0	QAM16	24.00	22.64
Band8	10	21500	50	#0	QAM16	24.00	21.63
Band8	10	21625	1	#0	QPSK	24.00	23.55

Band8	10	21625	12	#0	QPSK	24.00	23.61
Band8	10	21625	50	#0	QPSK	24.00	22.62
Band8	10	21625	1	#0	QAM16	24.00	22.68
Band8	10	21625	12	#0	QAM16	24.00	22.53
Band8	10	21625	50	#0	QAM16	24.00	21.67
Band8	10	21750	1	#0	QPSK	24.00	23.64
Band8	10	21750	12	#0	QPSK	24.00	23.60
Band8	10	21750	50	#0	QPSK	24.00	22.60
Band8	10	21750	1	#0	QAM16	24.00	22.44
Band8	10	21750	12	#0	QAM16	24.00	22.67
Band8	10	21750	50	#0	QAM16	24.00	21.66

7.4. WLAN & Bluetooth Output Power

Mode	Channel	Frequency (MHz)	Tune-up	Output Power (dBm)
802.11b	1	2412	15.50	15.20
	7	2442	15.50	15.01
	13	2472	15.50	15.17
802.11g	1	2412	14.00	13.79
	7	2442	14.00	13.66
	13	2472	14.00	13.10
802.11n (HT20)	1	2412	13.00	12.30
	7	2442	13.00	12.56
	13	2472	13.00	12.40

NOTE: Power measurement results of WLAN 2.4G.

Mode	Channel	Frequency (MHz)	Tune - up	Output Power (dBm)
802.11a	36	5180	6.50	6.29
	40	5200	6.50	6.21
	48	5240	6.50	6.22
802.11n (HT20)	36	5180	6.00	5.99
	40	5200	6.00	5.95
	48	5240	6.00	5.88
802.11n (HT40)	38	5190	6.00	5.68
	46	5230	6.00	5.59

NOTE: Power measurement results of WLAN5.2G. Refer to EN 62479, the available power of this EUT is 6.50dBm (4.47mW), the power is less than the low-power exclusion level defined in 4.2 (P max: 20mW), So WLAN5.2G stand-alone SAR is not required.

Mode	Channel	Frequency (MHz)	Tune-up	Output Power (dBm)
802.11a	149	5745	9.00	8.36
	157	5785	9.00	8.66
	165	5825	9.00	7.41
802.11n HT20	149	5745	8.50	7.16
	157	5785	8.50	8.07
	165	5825	8.50	7.24
802.11n HT40	151	5755	9.00	8.52
	159	5795	9.00	7.98

NOTE: Power measurement results of WLAN5.8G. Refer to EN 62479, the available power of this EUT is 9.00dBm (7.94mW), the power is less than the low-power exclusion level defined in 4.2 (P max: 20mW), So WLAN5.8G stand-alone SAR is not required.

BR+EDR	Data Rates	Tune - up	Output Power (dBm)
	GFSK DH5	10.00	9.79
	Pi/4 DQPSK DH5	7.00	6.59
	8DPSK DH5	7.50	7.33

BLE	Channel	Tune - up	Output Power (dBm)
	0CH	0.00	-0.04
	19CH	0.00	-0.47
	39CH	0.00	-0.39

NOTE: Power measurement results of Bluetooth. Refer to EN 62479, the available power of this EUT is 10.00dBm (10.00mW), the power is less than the low-power exclusion level defined in 4.2 (P max: 20mW), So Bluetooth stand-alone SAR is not required.

8. Assessment of the compliance of low power equipment

According to EN 62479 Clause 4.1& 4.2, these require does not apply to the receivers that has no transmit. So the FM and GPS is compliance.

9. SAR Results

9.1. SAR measurement results

9.1.1. SAR measurement Result of GSM900

Test	Test	Test Mode	Separation	SAR Value	Power	Conducted	Tune-up	Scaled	Date
------	------	-----------	------------	-----------	-------	-----------	---------	--------	------

Position	channel /Freq.		distance (mm)	(W/kg)		Drift (±5%)	power (dBm)	power (dBm)	SAR 10g (W/Kg)	
				1g	10g					
Head										
Left Cheek	38/897.6	GPRS(GMSK 3TS)	0	0.458	0.349	-0.56	30.65	31.00	0.378	2021/11/29
Left Tilt 15 Degree	38/897.6	GPRS(GMSK 3TS)	0	0.185	0.124	-3.83	30.65	31.00	0.134	2021/11/29
Right Cheek	38/897.6	GPRS(GMSK 3TS)	0	0.315	0.211	-1.70	30.65	31.00	0.229	2021/11/29
Right Tilt 15 Degree	38/897.6	GPRS(GMSK 3TS)	0	0.162	0.112	3.26	30.65	31.00	0.121	2021/11/29
Extremity										
Front Side	38/897.6	GPRS(GMSK 3TS)	0	2.065	0.977	2.43	30.65	31.00	1.059	2021/11/29
Back Side	38/897.6	GPRS(GMSK 3TS)	0	3.177	1.566	0.23	30.65	31.00	1.697	2021/11/29
Left Side	38/897.6	GPRS(GMSK 3TS)	0	1.303	0.642	2.15	30.65	31.00	0.696	2021/11/29
Right Side	38/897.6	GPRS(GMSK 3TS)	0	1.430	0.691	2.53	30.65	31.00	0.749	2021/11/29
Top Side	38/897.6	GPRS(GMSK 3TS)	0	0.381	0.180	0.33	30.65	31.00	0.195	2021/11/29
Bottom Side	38/897.6	GPRS(GMSK 3TS)	0	1.303	0.617	-1.17	30.65	31.00	0.669	2021/11/29
Body & Hotspot with 5mm (Worst-case position for 0mm)										
Back Side	38/897.6	GPRS(GMSK 3TS)	5	1.032	0.584	0.26	30.65	31.00	0.633	2021/11/29

9.1.2. SAR measurement Result of GSM1800

Test Position	Test channel /Freq.	Test Mode	Separation distance (mm)	SAR Value (W/kg)		Power Drift (±5%)	Conducted power (dBm)	Tune-up power (dBm)	Scaled SAR 10g (W/Kg)	Date
				1g	10g					
Head										
Left Cheek	698/1747.4	GPRS(GMSK 4TS)	0	0.244	0.152	-0.83	27.01	27.50	0.170	2021/11/26

Left Tilt 15 Degree	698/1747.4	GPRS(GMSK 4TS)	0	0.130	0.077	0.15	27.01	27.50	0.086	2021/11/26
Right Cheek	698/1747.4	GPRS(GMSK 4TS)	0	0.218	0.136	-0.58	27.01	27.50	0.152	2021/11/26
Right Tilt 15 Degree	698/1747.4	GPRS(GMSK 4TS)	0	0.115	0.068	1.63	27.01	27.50	0.076	2021/11/26
Extremity										
Front Side	698/1747.4	GPRS(GMSK 4TS)	0	1.889	0.882	1.83	27.01	27.50	0.987	2021/11/26
Back Side	698/1747.4	GPRS(GMSK 4TS)	0	2.998	1.414	-3.06	27.01	27.50	1.583	2021/11/26
Left Side	698/1747.4	GPRS(GMSK 4TS)	0	1.259	0.570	3.23	27.01	27.50	0.638	2021/11/26
Right Side	698/1747.4	GPRS(GMSK 4TS)	0	1.349	0.604	3.11	27.01	27.50	0.676	2021/11/26
Top Side	698/1747.4	GPRS(GMSK 4TS)	0	0.300	0.140	3.75	27.01	27.50	0.157	2021/11/26
Bottom Side	698/1747.4	GPRS(GMSK 4TS)	0	1.289	0.578	-2.92	27.01	27.50	0.647	2021/11/26
Body & Hotspot with 5mm (Worst-case position for 0mm)										
Back Side	698/1747.4	GPRS(GMSK 4TS)	5	1.349	0.560	-2.61	27.01	27.50	0.627	2021/11/26

9.1.3. SAR measurement Result of WCDMA Band 1

Test Position	Test channel /Freq.	Test Mode	Separation distance (mm)	SAR Value (W/kg)		Power Drift (±5%)	Conducted power (dBm)	Tune-up power (dBm)	Scaled SAR 10g (W/Kg)	Date
				1g	10g					
Head										
Left Cheek	9750/1950	RMC12.2K	0	0.202	0.120	-2.35	23.04	23.50	0.133	2021/11/22
Left Tilt 15 Degree	9750/1950	RMC12.2K	0	0.120	0.070	5.00	23.04	23.50	0.078	2021/11/22
Right Cheek	9750/1950	RMC12.2K	0	0.173	0.103	4.59	23.04	23.50	0.115	2021/11/22
Right Tilt 15	9750/1950	RMC12.2K	0	0.095	0.056	4.23	23.04	23.50	0.062	2021/11/22

Degree										
Extremity										
Front Side	9750/1950	RMC12.2K	0	1.299	0.608	3.18	23.04	23.50	0.676	2021/11/22
Back Side	9750/1950	RMC12.2K	0	2.062	0.985	-1.06	23.04	23.50	1.095	2021/11/22
Left Side	9750/1950	RMC12.2K	0	0.825	0.382	-0.66	23.04	23.50	0.425	2021/11/22
Right Side	9750/1950	RMC12.2K	0	0.825	0.394	-3.61	23.04	23.50	0.438	2021/11/22
Top Side	9750/1950	RMC12.2K	0	0.289	0.138	0.46	23.04	23.50	0.153	2021/11/22
Bottom Side	9750/1950	RMC12.2K	0	0.866	0.410	-3.60	23.04	23.50	0.456	2021/11/22
Body & Hotspot with 5mm (Worst-case position for 0mm)										
Back Side	9750/1950	RMC12.2K	5	1.299	0.529	0.94	23.04	23.50	0.588	2021/11/22

9.1.4. SAR measurement Result of WCDMA Band 8

Test Position	Test channel /Freq.	Test Mode	Separation distance (mm)	SAR Value (W/kg)		Power Drift (±5%)	Conducted power (dBm)	Tune-up power (dBm)	Scaled SAR 10g (W/Kg)	Date
				1g	10g					
Head										
Left Cheek	2788/897.6	RMC12.2K	0	0.171	0.128	-1.48	22.69	23.00	0.137	2021/11/29
Left Tilt 15 Degree	2788/897.6	RMC12.2K	0	0.087	0.064	2.48	22.69	23.00	0.069	2021/11/29
Right Cheek	2788/897.6	RMC12.2K	0	0.154	0.114	-4.01	22.69	23.00	0.122	2021/11/29
Right Tilt 15 Degree	2788/897.6	RMC12.2K	0	0.075	0.056	-3.11	22.69	23.00	0.060	2021/11/29
Extremity										
Front Side	2788/897.6	RMC12.2K	0	0.945	0.468	0.13	22.69	23.00	0.503	2021/11/29
Back Side	2788/897.6	RMC12.2K	0	1.524	0.794	-0.50	22.69	23.00	0.853	2021/11/29
Left	2788/897.6	RMC12.2K	0	0.625	0.322	3.03	22.69	23.00	0.346	2021/11/29

Side										
Right Side	2788/897.6	RMC12.2K	0	0.686	0.343	3.00	22.69	23.00	0.368	2021/11/29
Top Side	2788/897.6	RMC12.2K	0	0.213	0.111	-0.14	22.69	23.00	0.119	2021/11/29
Bottom Side	2788/897.6	RMC12.2K	0	0.640	0.320	2.55	22.69	23.00	0.344	2021/11/29
Body & Hotspot with 5mm (Worst-case position for 0mm)										
Back Side	2788/897.6	RMC12.2K	5	0.914	0.476	3.97	22.69	23.00	0.511	2021/11/29

9.1.5. SAR measurement Result of LTE Band 1

Test Position	Test channel /Freq.	Test Mode	Separation distance (mm)	SAR Value (W/kg)		Power Drift (±5%)	Conducted power (dBm)	Tune-up power (dBm)	Scaled SAR 10g (W/Kg)	Date
				1g	10g					
Head										
Left Cheek	18300/1950	20M QPSK(1,0)	0	0.257	0.153	-3.90	24.27	24.50	0.161	2021/11/22
Left Tilt 15 Degree	18300/1950	20M QPSK(1,0)	0	0.143	0.081	4.26	24.27	24.50	0.085	2021/11/22
Right Cheek	18300/1950	20M QPSK(1,0)	0	0.233	0.132	3.45	24.27	24.50	0.139	2021/11/22
Right Tilt 15 Degree	18300/1950	20M QPSK(1,0)	0	0.113	0.067	1.21	24.27	24.50	0.071	2021/11/22
Extremity										
Front Side	18300/1950	20M QPSK(1,0)	0	1.716	0.803	-0.92	24.27	24.50	0.847	2021/11/22
Back Side	18300/1950	20M QPSK(1,0)	0	2.681	1.307	-1.40	24.27	24.50	1.378	2021/11/22
Left Side	18300/1950	20M QPSK(1,0)	0	1.126	0.538	3.13	24.27	24.50	0.567	2021/11/22
Right Side	18300/1950	20M QPSK(1,0)	0	1.180	0.564	3.30	24.27	24.50	0.595	2021/11/22
Top Side	18300/1950	20M QPSK(1,0)	0	0.375	0.176	2.33	24.27	24.50	0.186	2021/11/22
Bottom Side	18300/1950	20M QPSK(1,0)	0	1.126	0.527	-3.60	24.27	24.50	0.556	2021/11/22

Body & Hotspot with 5mm (Worst-case position for 0mm)										
Back Side	18300/1950	20M QPSK(1,0)	5	1.126	0.532	0.75	24.27	24.50	0.561	2021/11/22

9.1.6. SAR measurement Result of LTE Band 3

Test Position	Test channel /Freq.	Test Mode	Separation distance (mm)	SAR Value (W/kg)		Power Drift (±5%)	Conducted power (dBm)	Tune-up power (dBm)	Scaled SAR 10g (W/Kg)	Date
				1g	10g					
Head										
Left Cheek	19575/1747.5	20M QPSK(1,0)	0	0.235	0.148	1.99	24.00	24.50	0.166	2021/11/26
Left Tilt 15 Degree	19575/1747.5	20M QPSK(1,0)	0	0.135	0.084	-0.32	24.00	24.50	0.094	2021/11/26
Right Cheek	19575/1747.5	20M QPSK(1,0)	0	0.207	0.125	0.76	24.00	24.50	0.140	2021/11/26
Right Tilt 15 Degree	19575/1747.5	20M QPSK(1,0)	0	0.114	0.072	-1.74	24.00	24.50	0.081	2021/11/26
Extremity										
Front Side	19575/1747.5	20M QPSK(1,0)	0	1.910	0.934	0.31	24.00	24.50	1.048	2021/11/26
Back Side	19575/1747.5	20M QPSK(1,0)	0	3.131	1.547	-2.56	24.00	24.50	1.736	2021/11/26
Left Side	19575/1747.5	20M QPSK(1,0)	0	1.378	0.647	1.99	24.00	24.50	0.726	2021/11/26
Right Side	19575/1747.5	20M QPSK(1,0)	0	1.346	0.658	-3.13	24.00	24.50	0.738	2021/11/26
Top Side	19575/1747.5	20M QPSK(1,0)	0	0.344	0.161	-0.98	24.00	24.50	0.181	2021/11/26
Bottom Side	19575/1747.5	20M QPSK(1,0)	0	1.409	0.696	0.05	24.00	24.50	0.781	2021/11/26
Body & Hotspot with 5mm (Worst-case position for 0mm)										
Back Side	19575/1747.5	20M QPSK(1,0)	5	1.062	0.516	-3.44	24.00	24.50	0.579	2021/11/26

9.1.7. SAR measurement Result of LTE Band 7

Test Position	Test channel /Freq.	Test Mode	Separation distance (mm)	SAR Value (W/kg)		Power Drift (±5%)	Conducted power (dBm)	Tune-up power (dBm)	Scaled SAR 10g (W/Kg)	Date
				1g	10g					
Head										
Left Cheek	21100/2535	20M QPSK(1,0)	0	0.372	0.206	-3.04	24.95	25.50	0.234	2021/12/06
Left Tilt 15 Degree	21100/2535	20M QPSK(1,0)	0	0.221	0.121	2.89	24.95	25.50	0.137	2021/12/06
Right Cheek	21100/2535	20M QPSK(1,0)	0	0.328	0.182	4.17	24.95	25.50	0.207	2021/12/06
Right Tilt 15 Degree	21100/2535	20M QPSK(1,0)	0	0.164	0.087	1.47	24.95	25.50	0.099	2021/12/06
Extremity										
Front Side	21100/2535	20M QPSK(1,0)	0	2.863	1.068	0.77	24.95	25.50	1.212	2021/12/06
Back Side	21100/2535	20M QPSK(1,0)	0	4.617	1.758	0.81	24.95	25.50	1.995	2021/12/06
Left Side	21100/2535	20M QPSK(1,0)	0	1.893	0.706	-0.63	24.95	25.50	0.801	2021/12/06
Right Side	21100/2535	20M QPSK(1,0)	0	2.078	0.783	-3.82	24.95	25.50	0.889	2021/12/06
Top Side	21100/2535	20M QPSK(1,0)	0	0.600	0.219	1.66	24.95	25.50	0.249	2021/12/06
Bottom Side	21100/2535	20M QPSK(1,0)	0	1.939	0.724	3.24	24.95	25.50	0.822	2021/12/06
Body & Hotspot with 5mm (Worst-case position for 0mm)										
Back Side	21100/2535	20M QPSK(1,0)	5	1.028	0.466	-0.85	24.95	25.50	0.529	2021/12/06

9.1.8. SAR measurement Result of LTE Band 8

Test Position	Test channel /Freq.	Test Mode	Separation distance (mm)	SAR Value (W/kg)		Power Drift (±5%)	Conducted power (dBm)	Tune-up power (dBm)	Scaled SAR 10g (W/Kg)	Date
				1g	10g					
Head										
Left Cheek	21625/897.5	10M QPSK(1,0)	0	0.216	0.161	1.19	23.55	24.00	0.179	2021/11/29

Left Tilt 15 Degree	21625/897.5	10M QPSK(1,0)	0	0.110	0.080	2.47	23.55	24.00	0.089	2021/11/29
Right Cheek	21625/897.5	10M QPSK(1,0)	0	0.192	0.139	-3.40	23.55	24.00	0.154	2021/11/29
Right Tilt 15 Degree	21625/897.5	10M QPSK(1,0)	0	0.091	0.066	3.05	23.55	24.00	0.073	2021/11/29
Extremity										
Front Side	21625/897.5	10M QPSK(1,0)	0	1.130	0.555	-2.73	23.55	24.00	0.616	2021/11/29
Back Side	21625/897.5	10M QPSK(1,0)	0	1.883	0.974	0.51	23.55	24.00	1.080	2021/11/29
Left Side	21625/897.5	10M QPSK(1,0)	0	0.772	0.395	2.01	23.55	24.00	0.438	2021/11/29
Right Side	21625/897.5	10M QPSK(1,0)	0	0.829	0.429	1.01	23.55	24.00	0.476	2021/11/29
Top Side	21625/897.5	10M QPSK(1,0)	0	0.264	0.134	0.04	23.55	24.00	0.149	2021/11/29
Bottom Side	21625/897.5	10M QPSK(1,0)	0	0.772	0.387	1.90	23.55	24.00	0.429	2021/11/29
Body & Hotspot with 5mm (Worst-case position for 0mm)										
Back Side	21625/897.5	10M QPSK(1,0)	5	0.772	0.387	-1.02	23.55	24.00	0.429	2021/11/29

9.1.9. SAR measurement Result of LTE Band 20

Test Position	Test channel /Freq.	Test Mode	Separation distance (mm)	SAR Value (W/kg)		Power Drift (±5%)	Conducted power (dBm)	Tune-up power (dBm)	Scaled SAR 10g (W/Kg)	Date
				1g	10g					
Head										
Left Cheek	24300/847	20M QPSK(1,0)	0	0.258	0.198	0.62	23.84	24.00	0.205	2021/11/29
Left Tilt 15 Degree	24300/847	20M QPSK(1,0)	0	0.136	0.103	-3.10	23.84	24.00	0.107	2021/11/29
Right Cheek	24300/847	20M QPSK(1,0)	0	0.241	0.176	-4.80	23.84	24.00	0.183	2021/11/29
Right	24300/847	20M	0	0.116	0.086	4.80	23.84	24.00	0.089	2021/11/29

Tilt 15 Degree		QPSK(1,0)								
Extremity										
Front Side	24300/847	20M QPSK(1,0)	0	1.217	0.612	-1.54	23.84	24.00	0.635	2021/11/29
Back Side	24300/847	20M QPSK(1,0)	0	1.932	1.022	-0.70	23.84	24.00	1.060	2021/11/29
Left Side	24300/847	20M QPSK(1,0)	0	0.869	0.441	-0.13	23.84	24.00	0.458	2021/11/29
Right Side	24300/847	20M QPSK(1,0)	0	0.869	0.437	2.80	23.84	24.00	0.453	2021/11/29
Top Side	24300/847	20M QPSK(1,0)	0	0.251	0.131	1.79	23.84	24.00	0.136	2021/11/29
Bottom Side	24300/847	20M QPSK(1,0)	0	0.869	0.450	2.41	23.84	24.00	0.467	2021/11/29
Body & Hotspot with 5mm (Worst-case position for 0mm)										
Back Side	24300/847	20M QPSK(1,0)	5	0.773	0.409	1.27	23.84	24.00	0.424	2021/11/29

9.1.10. SAR measurement Result of LTE Band 40

Test Position	Test channel /Freq.	Test Mode	Separation distance (mm)	SAR Value (W/kg)		Power Drift (±5%)	Conducted power (dBm)	Tune-up power (dBm)	Scaled SAR 10g (W/Kg)	Date
				1g	10g					
Head										
Left Cheek	39150/2350	20M QPSK(1,0)	0	0.190	0.118	-4.06	22.73	23.00	0.126	2021/12/03
Left Tilt 15 Degree	39150/2350	20M QPSK(1,0)	0	0.111	0.068	0.21	22.73	23.00	0.072	2021/12/03
Right Cheek	39150/2350	20M QPSK(1,0)	0	0.173	0.107	-4.38	22.73	23.00	0.114	2021/12/03
Right Tilt 15 Degree	39150/2350	20M QPSK(1,0)	0	0.091	0.055	-1.19	22.73	23.00	0.059	2021/12/03
Extremity										
Front Side	39150/2350	20M QPSK(1,0)	0	1.275	0.503	3.68	22.73	23.00	0.535	2021/12/03
Back Side	39150/2350	20M QPSK(1,0)	0	2.057	0.845	-3.23	22.73	23.00	0.899	2021/12/03

Left Side	39150/2350	20M QPSK(1,0)	0	0.885	0.364	2.86	22.73	23.00	0.387	2021/12/03
Right Side	39150/2350	20M QPSK(1,0)	0	0.864	0.348	-1.56	22.73	23.00	0.370	2021/12/03
Top Side	39150/2350	20M QPSK(1,0)	0	0.226	0.089	-3.09	22.73	23.00	0.095	2021/12/03
Bottom Side	39150/2350	20M QPSK(1,0)	0	0.864	0.355	-3.26	22.73	23.00	0.378	2021/12/03
Body & Hotspot with 5mm (Worst-case position for 0mm)										
Back Side	39150/2350	20M QPSK(1,0)	5	1.255	0.500	-3.78	22.73	23.00	0.532	2021/12/03

9.1.11. SAR measurement Result of WLAN 2.4G

Test Position	Test channel /Freq.	Test Mode	Separation distance (mm)	SAR Value (W/kg)		Power Drift (±5%)	Conducted power (dBm)	Tune-up power (dBm)	Scaled SAR 10g (W/Kg)	Date
				1g	10g					
Head										
Left Cheek	7/2442	802.11 b	0	0.226	0.120	-1.26	15.01	15.50	0.134	2021/11/27
Left Tilt 15 Degree	7/2442	802.11 b	0	0.131	0.069	2.29	15.01	15.50	0.077	2021/11/27
Right Cheek	7/2442	802.11 b	0	0.204	0.103	3.69	15.01	15.50	0.115	2021/11/27
Right Tilt 15 Degree	7/2442	802.11 b	0	0.098	0.049	-4.94	15.01	15.50	0.055	2021/11/27
Extremity										
Front Side	7/2442	802.11 b	0	0.491	0.183	-2.62	15.01	15.50	0.205	2021/11/27
Back Side	7/2442	802.11 b	0	0.767	0.465	-2.61	15.01	15.50	0.521	2021/11/27
Left Side	7/2442	802.11 b	0	0.245	0.092	-3.53	15.01	15.50	0.103	2021/11/27
Right Side	7/2442	802.11 b	0	0.330	0.121	-1.55	15.01	15.50	0.135	2021/11/27
Top Side	7/2442	802.11 b	0	0.314	0.117	-1.21	15.01	15.50	0.131	2021/11/27
Bottom	7/2442	802.11 b	0	0.084	0.032	2.15	15.01	15.50	0.036	2021/11/27

Side		b								
Body & Hotspot with 5mm (Worst-case position for 0mm)										
Back Side	7/2442	802.11 b	5	0.286	0.090	-0.13	15.01	15.50	0.101	2021/11/27

9.2. Simultaneous Transmission Analysis

Refer to EN 62209-2:2010 Annex K, the secondary transmitter SAR test exclusion thresholds are determined by:

$$P_{\text{available}} = P_{\text{th,m}} \left(\frac{SAR_{\text{lim}} - SAR_1}{SAR_{\text{lim}}} \right)$$

$P_{\text{th,m}}$ is the threshold exclusion power level taken from Annex B of EN 62479.

Mode	P_{max} (dBm)	P_{max} (mW)	$P_{\text{th,m}}$ (mW)	SAR_{lim} (W/Kg)	SAR_1 (W/Kg)	Calculation Result (mW)	Simultaneous Transmission Exclusion
Bluetooth	10.00	10.00	20	2	0.633	13.67	YES
Bluetooth	10.00	10.00	40	4	1.995	20.05	YES
WLAN 5.2G	6.50	4.47	20	2	0.633	13.67	YES
WLAN 5.2G	6.50	4.47	40	4	1.995	20.05	YES
WLAN 5.8G	9.00	7.94	20	2	0.633	13.67	YES
WLAN 5.8G	9.00	7.94	40	4	1.995	20.05	YES

9.3. Exposure Conditions

Exposure Position		WWAN Band	WLAN Band	Simultaneous Tx SAR(W/Kg)
		SAR(W/Kg)	SAR(W/Kg)	
Head	Left Cheek	0.378	0.134	0.512
	Left Tilt 15 Degree	0.137	0.077	0.214
	Right Cheek	0.229	0.115	0.344
	Right Tilt 15 Degree	0.121	0.055	0.176
Member	Front Side	1.212	0.205	1.417
	Back Side	1.995	0.521	2.516
	Left Side	0.801	0.103	0.904
	Right Side	0.889	0.135	1.024

	Top Side	0.249	0.131	0.380
	Bottom Side	0.822	0.036	0.858
Body&Hotspot	Back Side	0.633	0.101	0.734

NOTE: The Simultaneous Tx is calculated based on the same configuration and test position.

10. Appendix A. Photo documentation

Test Positions

Left Cheek

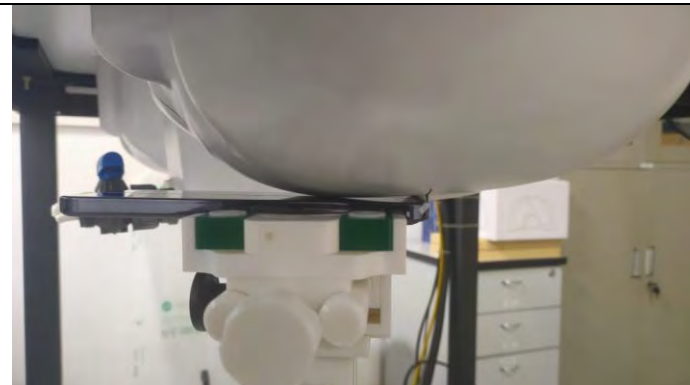

Left Tilt 15 Degree



Right Cheek

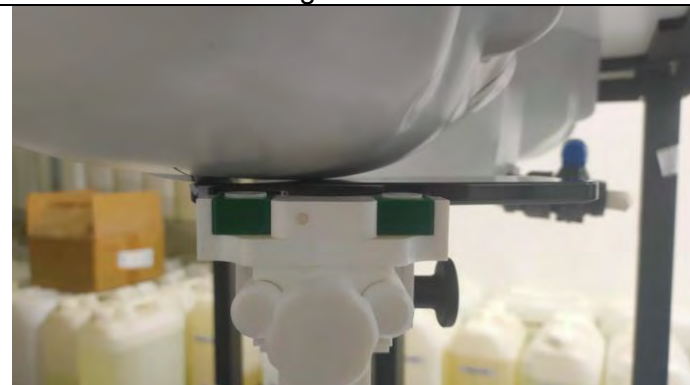

Right Tilt 15 Degree



Front Side
(Separation distance of 0mm)



Back Side
(Separation distance of 0mm)

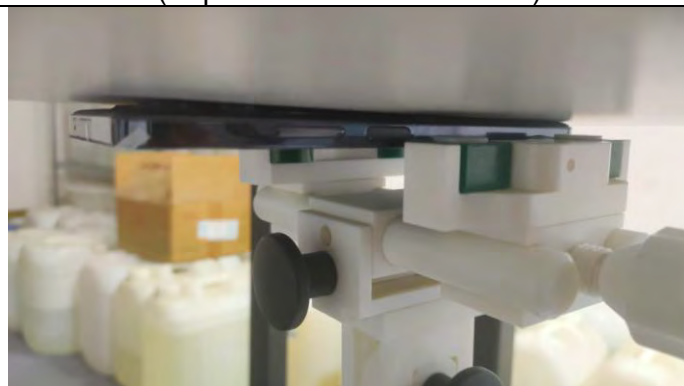



Left Side
(Separation distance of 0mm)



Right Side
(Separation distance of 0mm)



<p>Top Side (Separation distance of 0mm)</p>	<p>Bottom Side (Separation distance of 0mm)</p>
	
<p>Back Side (Separation distance of 5mm)</p>	<p>N/A</p>
	<p>N/A</p>

11. Appendix B. System Check Plots

Table of contents
MEASUREMENT 1 System Performance Check - 900MHz
MEASUREMENT 2 System Performance Check - 1800MHz
MEASUREMENT 3 System Performance Check - 2000MHz
MEASUREMENT 4 System Performance Check - 2300MHz
MEASUREMENT 5 System Performance Check - 2450MHz
MEASUREMENT 6 System Performance Check - 2600MHz

MEASUREMENT 1

Date of measurement: 29/11/2021

A. Experimental conditions.

Area Scan	<u>dx=15mm dy=15mm, h= 5.00 mm</u>
ZoomScan	<u>5x5x7, dx=8mm dy=8mm dz=5mm</u>
Phantom	<u>Validation plane</u>
Device Position	<u>Dipole</u>
Band	<u>CW900</u>
Channels	<u>Middle</u>
Signal	<u>CW (Crest factor: 1.0)</u>

B. SAR Measurement Results

Frequency (MHz)	900.000000
Relative permittivity (real part)	42.106772
Relative permittivity (imaginary part)	20.046187
Conductivity (S/m)	1.002309
Variation (%)	2.730000

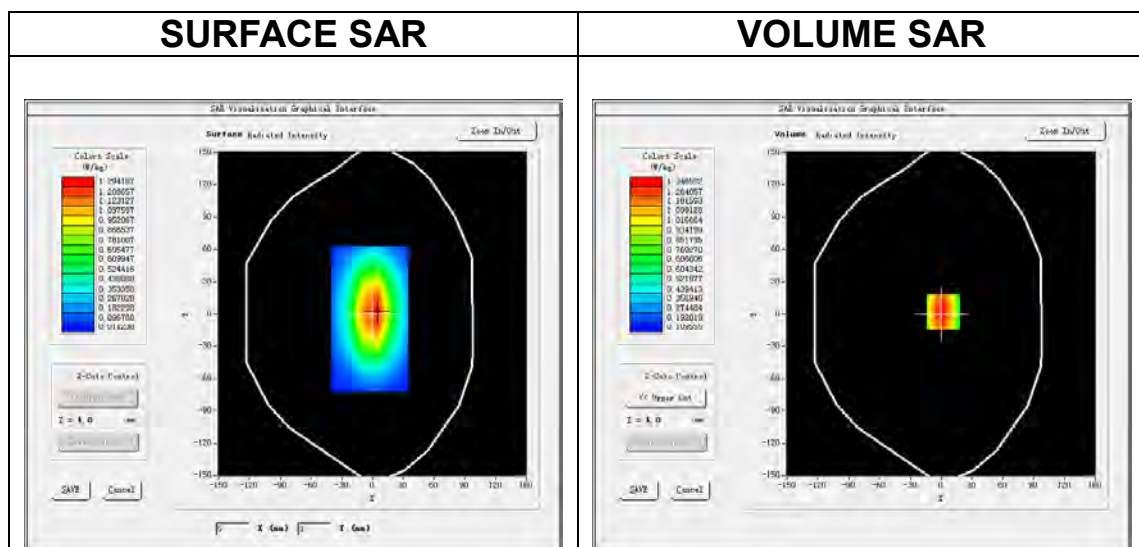

Maximum location: X=2.00, Y=2.00

SAR Peak: 1.87 W/kg

SAR 10g (W/Kg)	0.709125
SAR 1g (W/Kg)	1.109161

Z (mm)	0.00	4.00	9.00	14.00	19.00	24.00	29.00
SAR (W/Kg)	1.8747	1.3465	0.8967	0.6160	0.4274	0.3010	0.2119

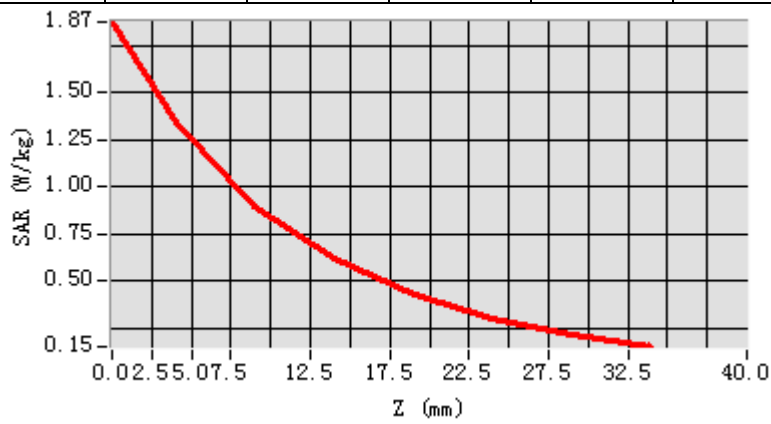

3D screen shot

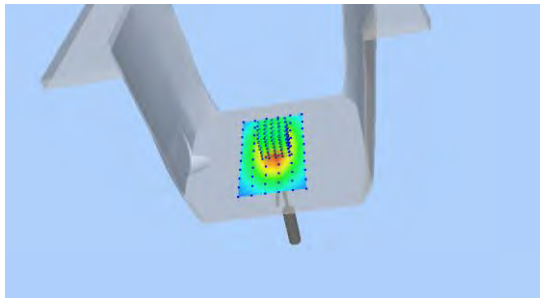

Hot spot position

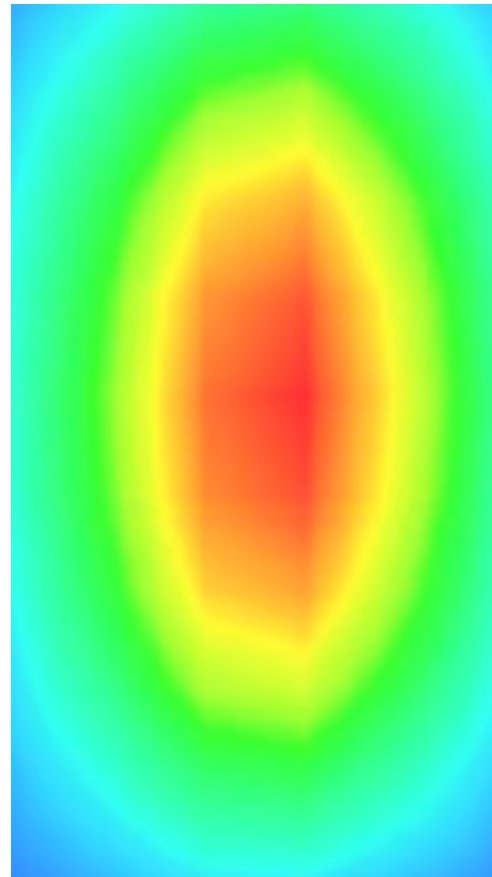

MEASUREMENT 2

Date of measurement: 26/11/2021

A. Experimental conditions.

Area Scan	<u>dx=15mm dy=15mm, h= 5.00 mm</u>
ZoomScan	<u>5x5x7, dx=8mm dy=8mm dz=5mm</u>
Phantom	<u>Validation plane</u>
Device Position	<u>Dipole</u>
Band	<u>CW1800</u>
Channels	<u>Middle</u>
Signal	<u>CW (Crest factor: 1.0)</u>

B. SAR Measurement Results

Frequency (MHz)	1800.000000
Relative permittivity (real part)	39.140208
Relative permittivity (imaginary part)	14.028527
Conductivity (S/m)	1.402853
Variation (%)	-2.720000

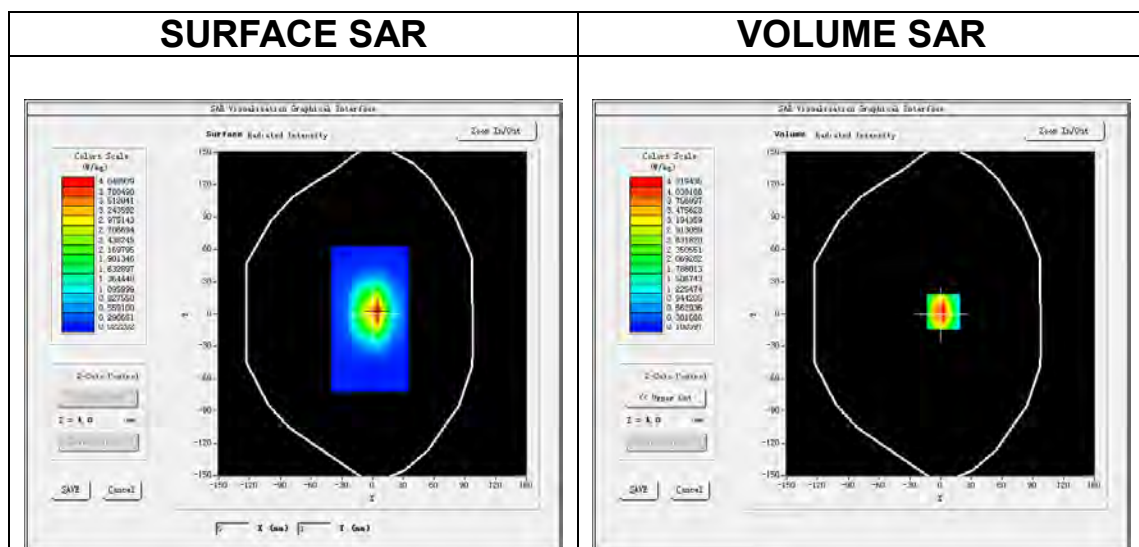

Maximum location: X=3.00, Y=2.00

SAR Peak: 6.82 W/kg

SAR 10g (W/Kg)	1.991333
SAR 1g (W/Kg)	3.626172

Z (mm)	0.00	4.00	9.00	14.00	19.00	24.00	29.00
SAR (W/Kg)	6.7421	4.3159	2.4332	1.4262	0.8563	0.5209	0.3226

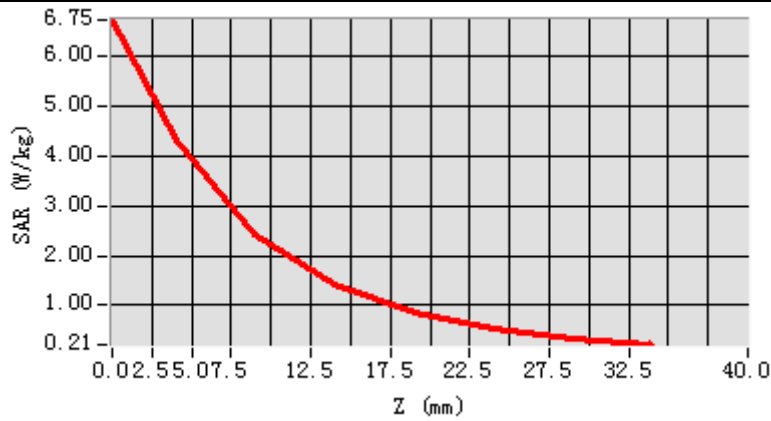

3D screen shot

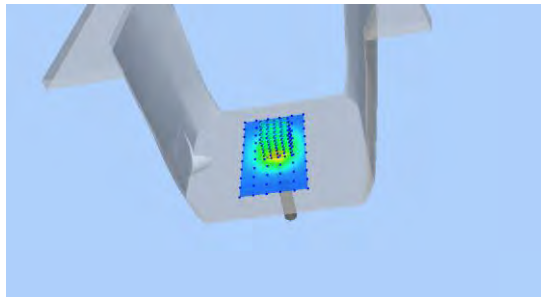

Hot spot position

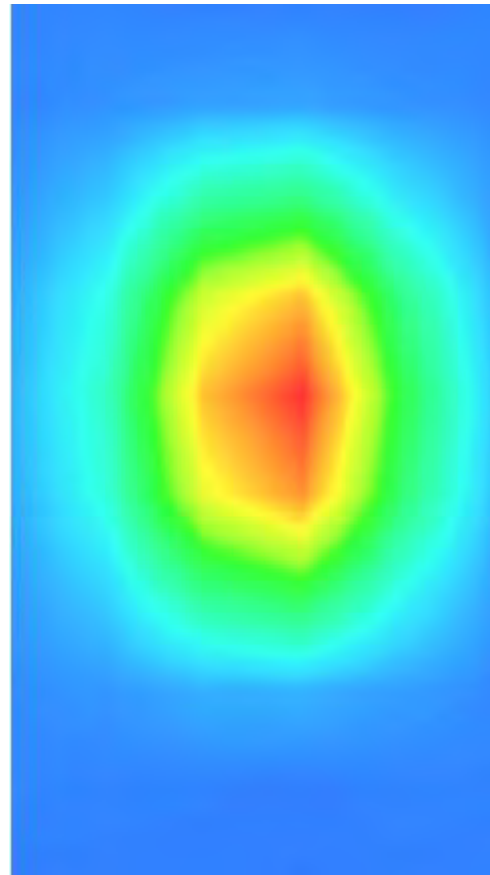

MEASUREMENT 3

Date of measurement: 22/11/2021

A. Experimental conditions.

Area Scan	<u>dx=15mm dy=15mm, h= 5.00 mm</u>
ZoomScan	<u>5x5x7, dx=8mm dy=8mm dz=5mm</u>
Phantom	<u>Validation plane</u>
Device Position	<u>Dipole</u>
Band	<u>CW2000</u>
Channels	<u>Middle</u>
Signal	<u>CW (Crest factor: 1.0)</u>

B. SAR Measurement Results

Frequency (MHz)	2000.000000
Relative permittivity (real part)	41.509963
Relative permittivity (imaginary part)	12.600365
Conductivity (S/m)	1.400041
Variation (%)	2.980000

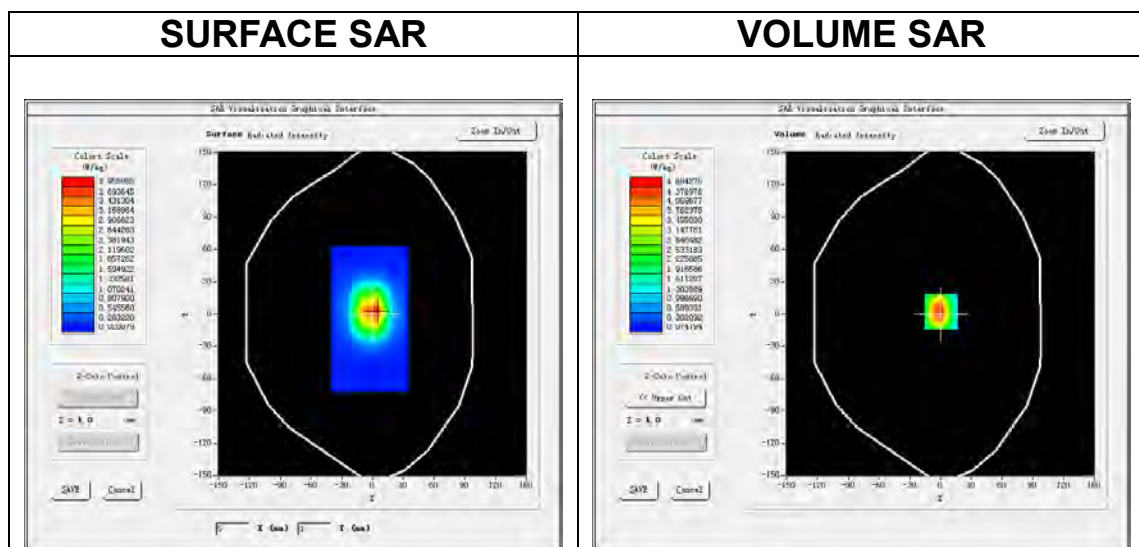

Maximum location: X=1.00, Y=2.00

SAR Peak: 7.65 W/kg

SAR 10g (W/Kg)	2.172307
SAR 1g (W/Kg)	4.133066

Z (mm)	0.00	4.00	9.00	14.00	19.00	24.00	29.00
SAR (W/Kg)	7.5474	4.6811	2.5029	1.3803	0.7772	0.4431	0.2634

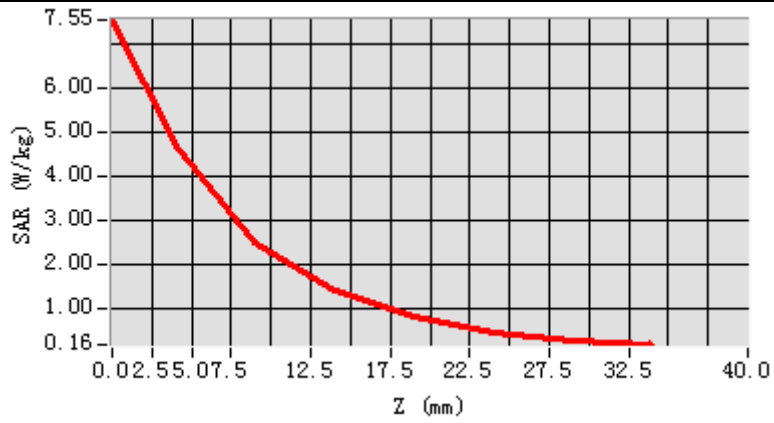

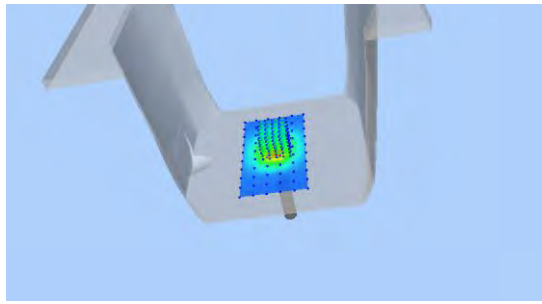
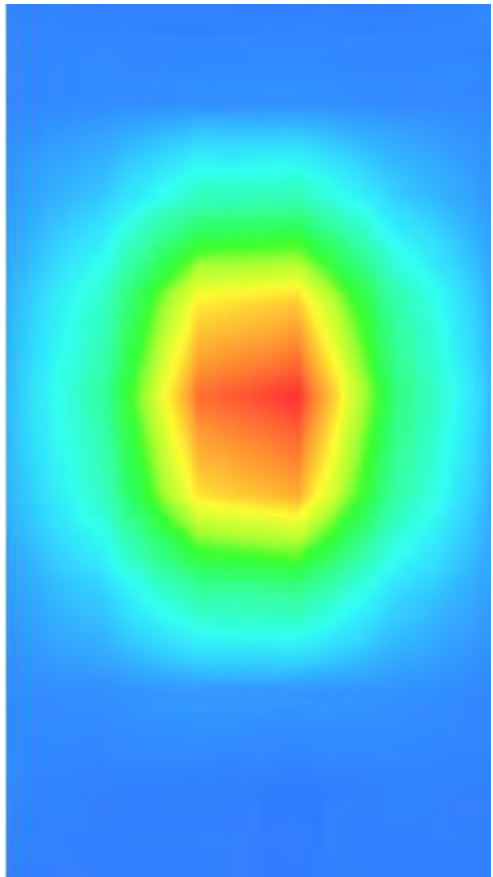
3D screen shot	Hot spot position
	

MEASUREMENT 4

Date of measurement: 3/12/2021

A. Experimental conditions.

Area Scan	<u>dx=12mm dy=12mm, h= 5.00 mm</u>
ZoomScan	<u>7x7x7,dx=5mm dy=5mm dz=5mm</u>
Phantom	<u>Validation plane</u>
Device Position	<u>Dipole</u>
Band	<u>CW2300</u>
Channels	<u>Middle</u>
Signal	<u>CW (Crest factor: 1.0)</u>

B. SAR Measurement Results

Frequency (MHz)	2300.000000
Relative permittivity (real part)	39.714667
Relative permittivity (imaginary part)	13.254208
Conductivity (S/m)	1.693593
Variation (%)	2.220000

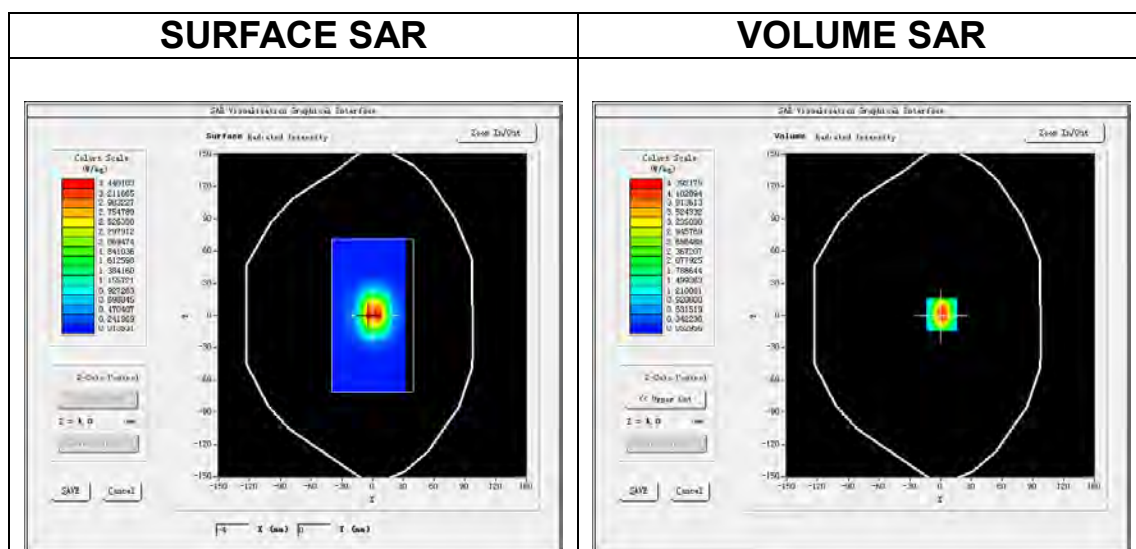

Maximum location: X=1.00, Y=1.00

SAR Peak: 7.04 W/kg

SAR 10g (W/Kg)	2.530347
SAR 1g (W/Kg)	5.216221

Z (mm)	0.00	4.00	9.00	14.00	19.00	24.00	29.00
SAR (W/Kg)	7.0347	4.3919	2.3630	1.2726	0.7118	0.4014	0.2394

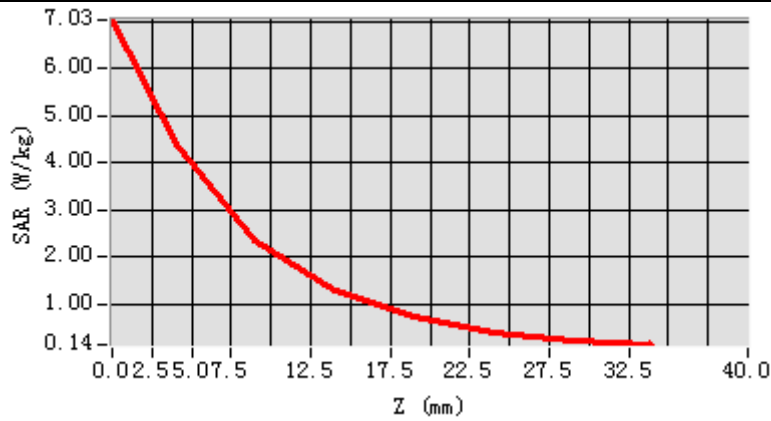

3D screen shot

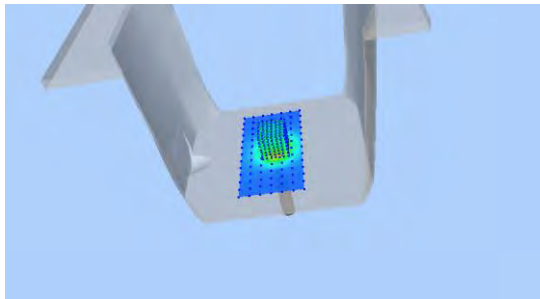

Hot spot position

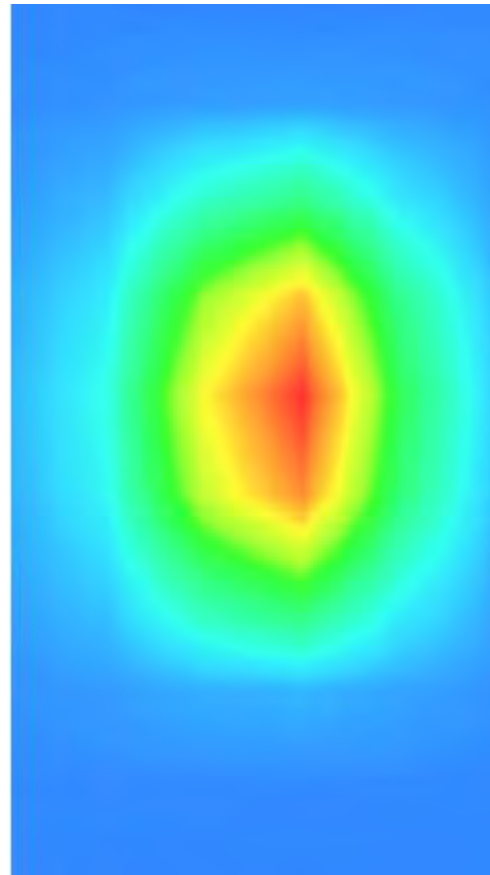

MEASUREMENT 5

Date of measurement: 27/11/2021

A. Experimental conditions.

Area Scan	<u>dx=12mm dy=12mm, h= 5.00 mm</u>
ZoomScan	<u>7x7x7,dx=5mm dy=5mm dz=5mm</u>
Phantom	<u>Validation plane</u>
Device Position	<u>Dipole</u>
Band	<u>CW2450</u>
Channels	<u>Middle</u>
Signal	<u>CW (Crest factor: 1.0)</u>

B. SAR Measurement Results

Frequency (MHz)	2450.000000
Relative permittivity (real part)	40.508151
Relative permittivity (imaginary part)	13.178854
Conductivity (S/m)	1.793788
Variation (%)	1.290000

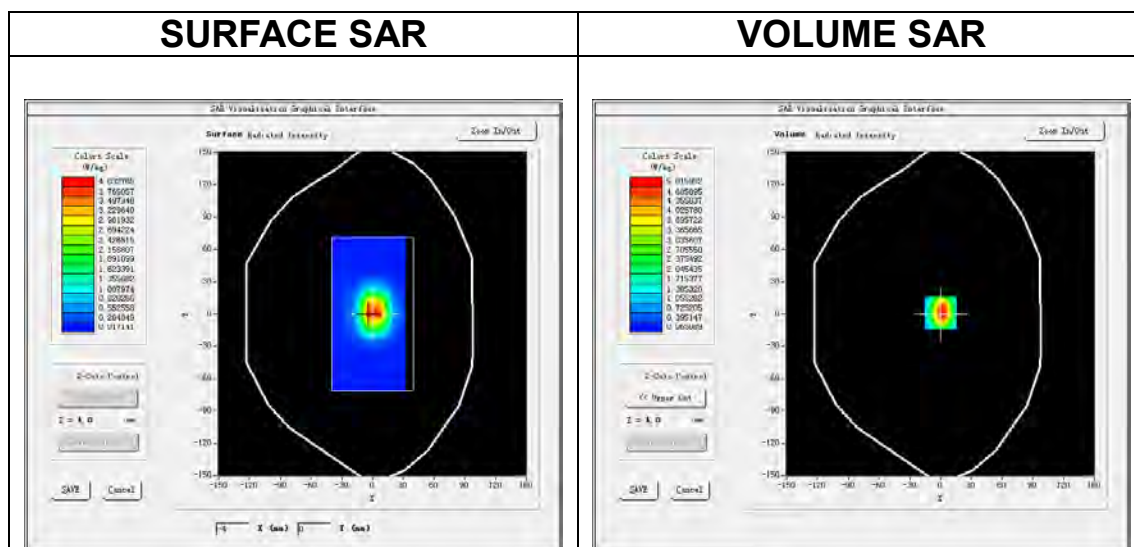

Maximum location: X=0.00, Y=1.00

SAR Peak: 8.14 W/kg

SAR 10g (W/Kg)	2.491106
SAR 1g (W/Kg)	5.730340

Z (mm)	0.00	4.00	9.00	14.00	19.00	24.00	29.00
SAR (W/Kg)	8.0397	5.0153	2.6927	1.4826	0.8361	0.4698	0.2660

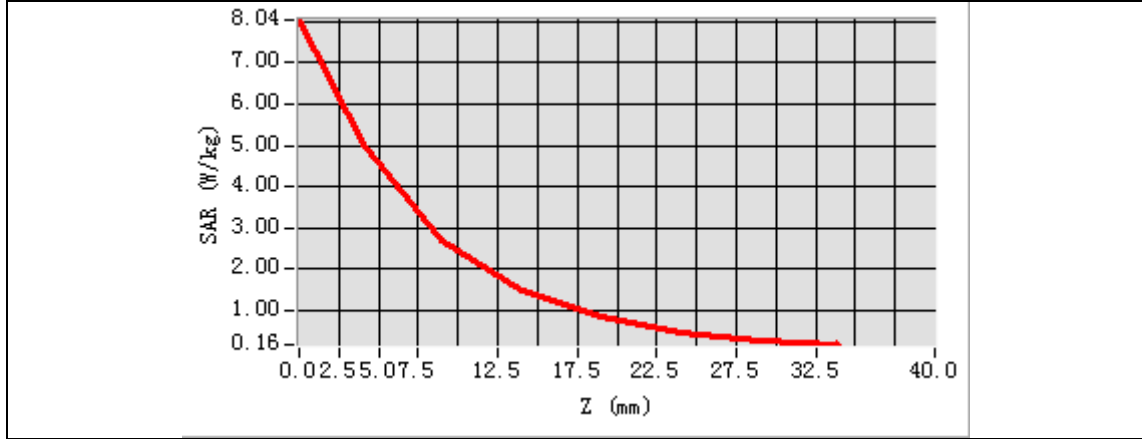

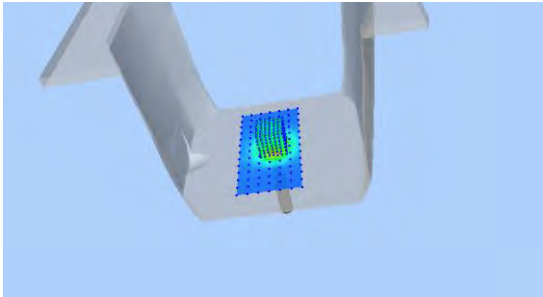
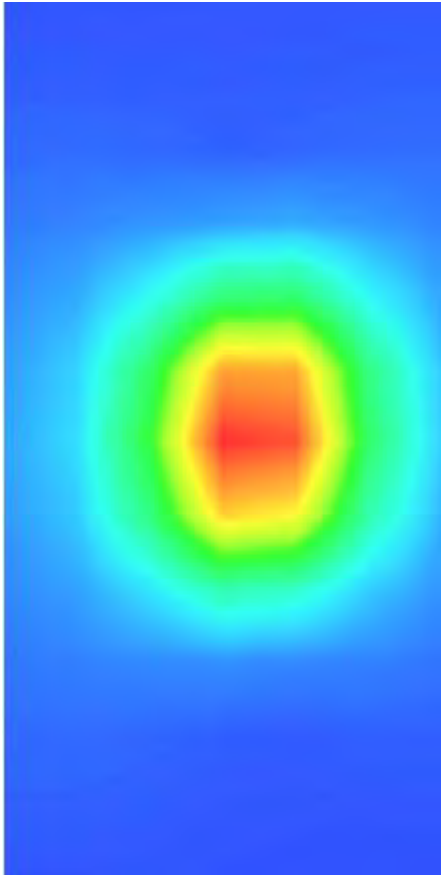
3D screen shot	Hot spot position
	

MEASUREMENT 6

Date of measurement: 6/12/2021

A. Experimental conditions.

Area Scan	<u>dx=12mm dy=12mm, h= 5.00 mm</u>
ZoomScan	<u>7x7x7,dx=5mm dy=5mm dz=5mm</u>
Phantom	<u>Validation plane</u>
Device Position	<u>Dipole</u>
Band	<u>CW2600</u>
Channels	<u>Middle</u>
Signal	<u>CW (Crest factor: 1.0)</u>

B. SAR Measurement Results

Frequency (MHz)	2600.000000
Relative permittivity (real part)	39.365914
Relative permittivity (imaginary part)	13.647111
Conductivity (S/m)	1.971249
Variation (%)	0.250000

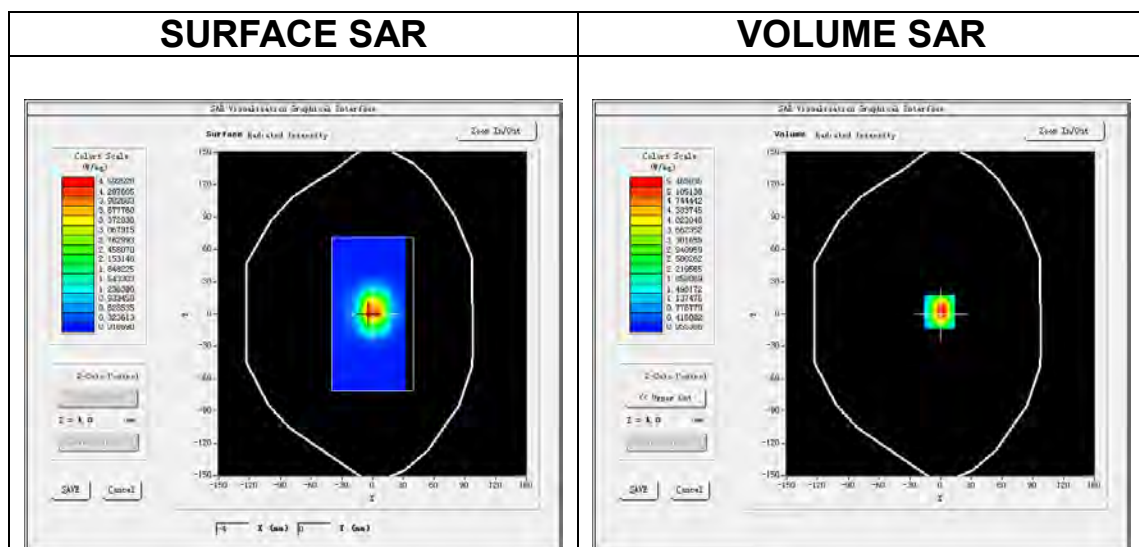

Maximum location: X=-1.00, Y=2.00

SAR Peak: 9.07 W/kg

SAR 10g (W/Kg)	2.567037
SAR 1g (W/Kg)	5.292199

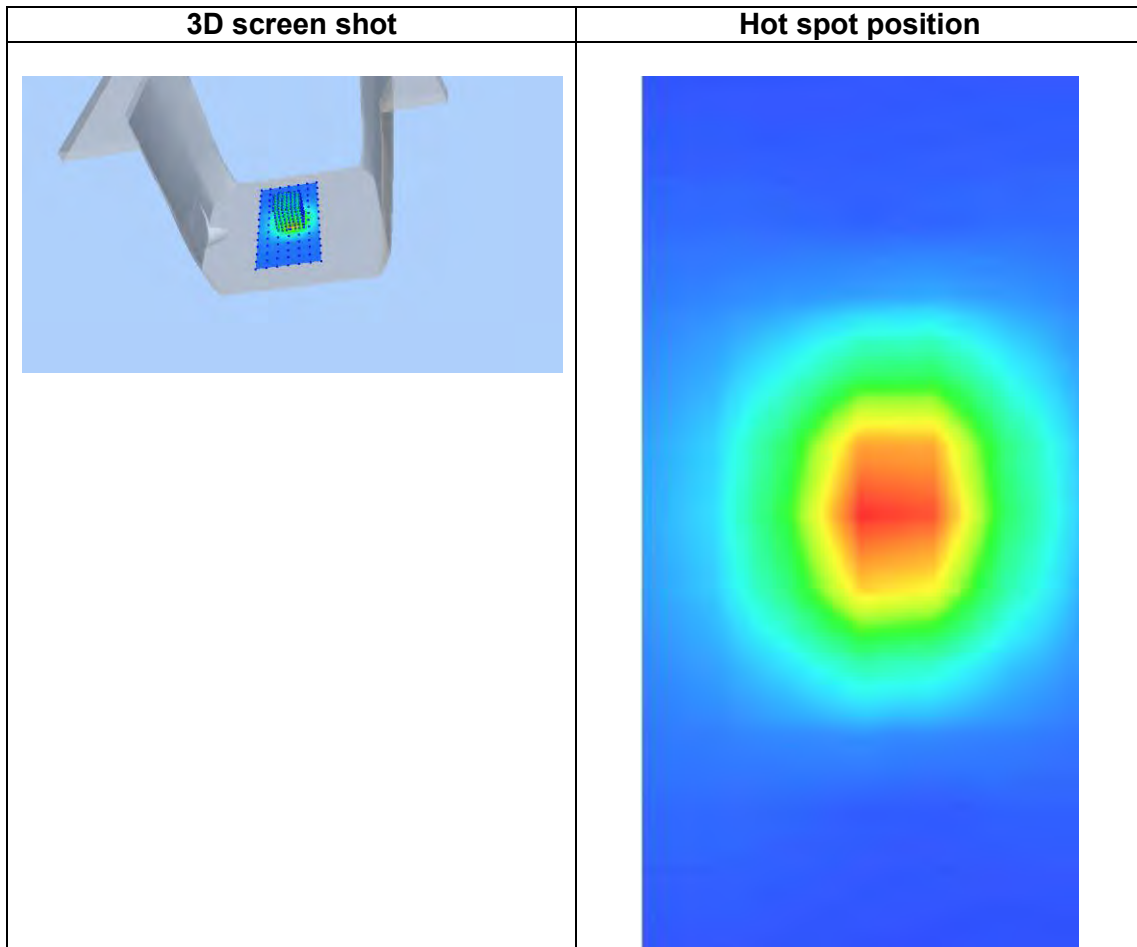
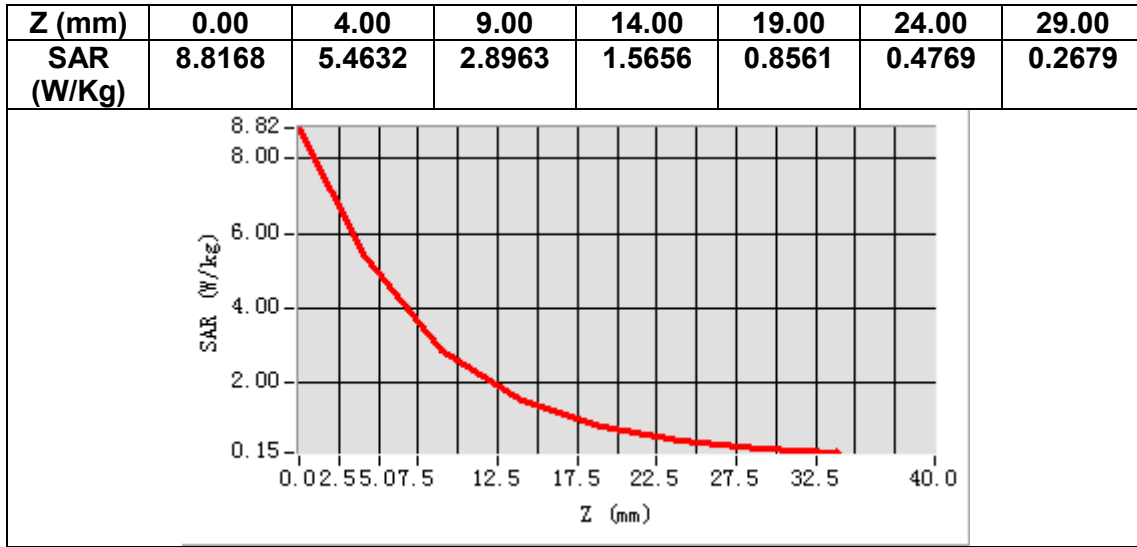

12. Appendix C. Plots of High SAR Measurement

Table of contents
MEASUREMENT 1 GSM 900 Head
MEASUREMENT 2 GSM 900 Extremity
MEASUREMENT 3 GSM 1800 Head
MEASUREMENT 4 GSM 1800 Extremity
MEASUREMENT 5 WCDMA Band 1 Head
MEASUREMENT 6 WCDMA Band 1 Extremity
MEASUREMENT 7 WCDMA Band 8 Head
MEASUREMENT 8 WCDMA Band 8 Extremity
MEASUREMENT 9 WLAN 2.4G Head
MEASUREMENT 10 WLAN 2.4G Extremity
MEASUREMENT 11 LTE Band 1 Head
MEASUREMENT 12 LTE Band 1 Extremity
MEASUREMENT 13 LTE Band 3 Head
MEASUREMENT 14 LTE Band 3 Extremity
MEASUREMENT 15 LTE Band 7 Head
MEASUREMENT 16 LTE Band 7 Extremity
MEASUREMENT 17 LTE Band 8 Head
MEASUREMENT 18 LTE Band 8 Extremity
MEASUREMENT 19 LTE Band 20 Head
MEASUREMENT 20 LTE Band 20 Extremity
MEASUREMENT 21 LTE Band 40 Head
MEASUREMENT 22 LTE Band 40 Extremity

MEASUREMENT 1

Date of measurement: 29/11/2021

A. Experimental conditions.

Area Scan	<u>dx=15mm dy=15mm, h= 5.00 mm</u>
ZoomScan	<u>5x5x7, dx=8mm dy=8mm dz=5mm</u>
Phantom	<u>Left head</u>
Device Position	<u>Cheek</u>
Band	<u>GSM900</u>
Channels	<u>Middle</u>
Signal	<u>TDMA (Crest factor: 2.7)</u>

B. SAR Measurement Results

Frequency (MHz)	897.600000
Relative permittivity (real part)	42.187134
Relative permittivity (imaginary part)	20.100006
Conductivity (S/m)	1.002320
Variation (%)	-0.560000

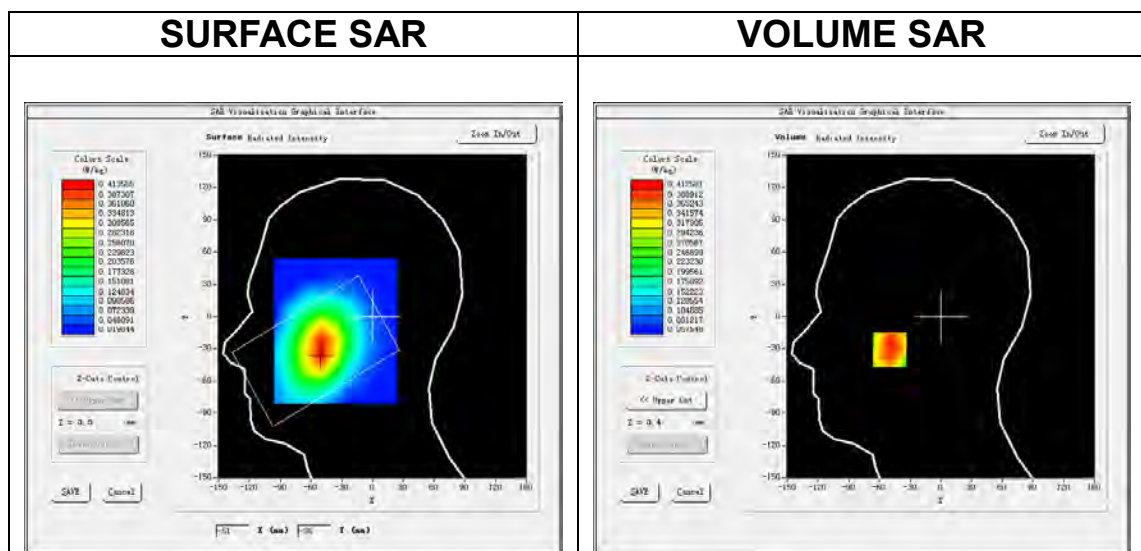

Maximum location: X=-50.00, Y=-31.00

SAR Peak: 0.67 W/kg

SAR 10g (W/Kg)	0.348914
SAR 1g (W/Kg)	0.457961

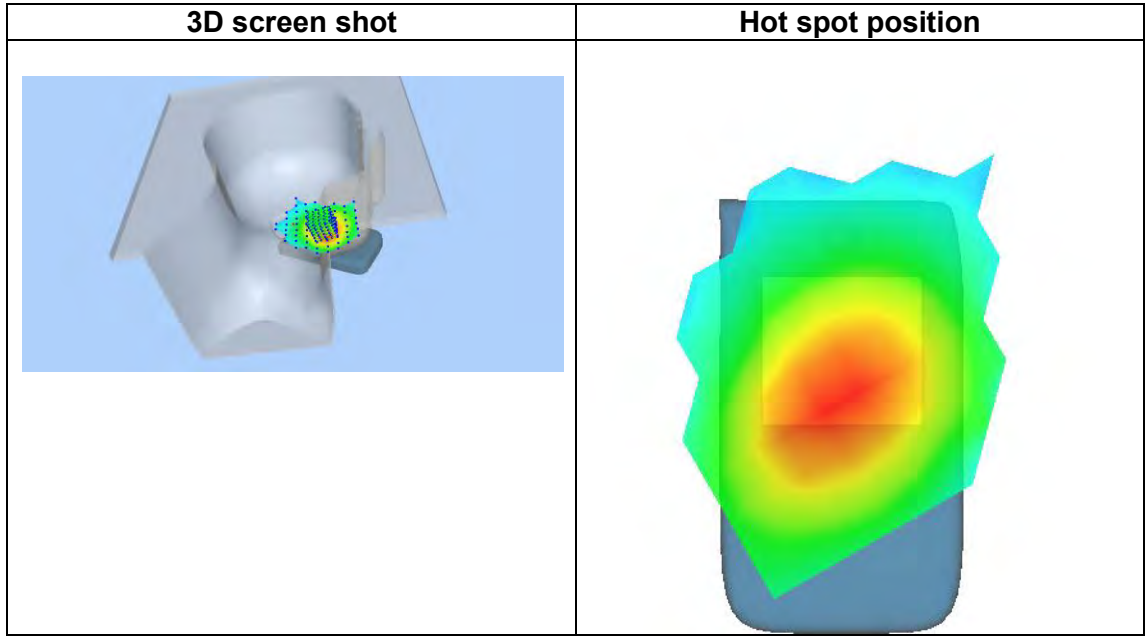
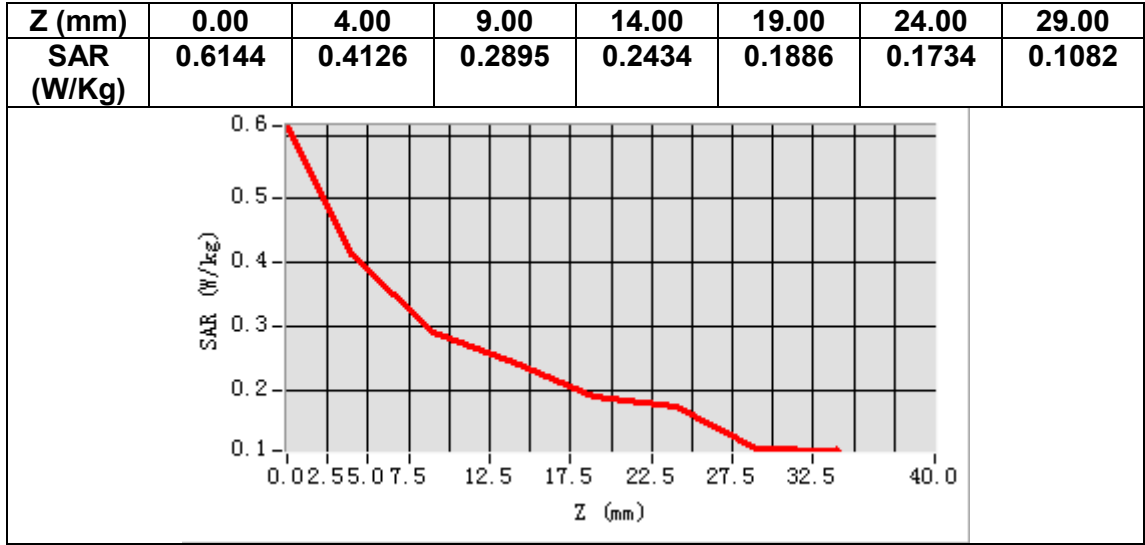

MEASUREMENT 2

Date of measurement: 29/11/2021

A. Experimental conditions.

Area Scan	<u>dx=15mm dy=15mm, h= 5.00 mm</u>
ZoomScan	<u>5x5x7, dx=8mm dy=8mm dz=5mm</u>
Phantom	<u>Validation plane</u>
Device Position	<u>Body</u>
Band	<u>GSM900</u>
Channels	<u>Middle</u>
Signal	<u>TDMA (Crest factor: 2.7)</u>

B. SAR Measurement Results

Frequency (MHz)	897.600000
Relative permittivity (real part)	42.187134
Relative permittivity (imaginary part)	20.100006
Conductivity (S/m)	1.002320
Variation (%)	0.230000

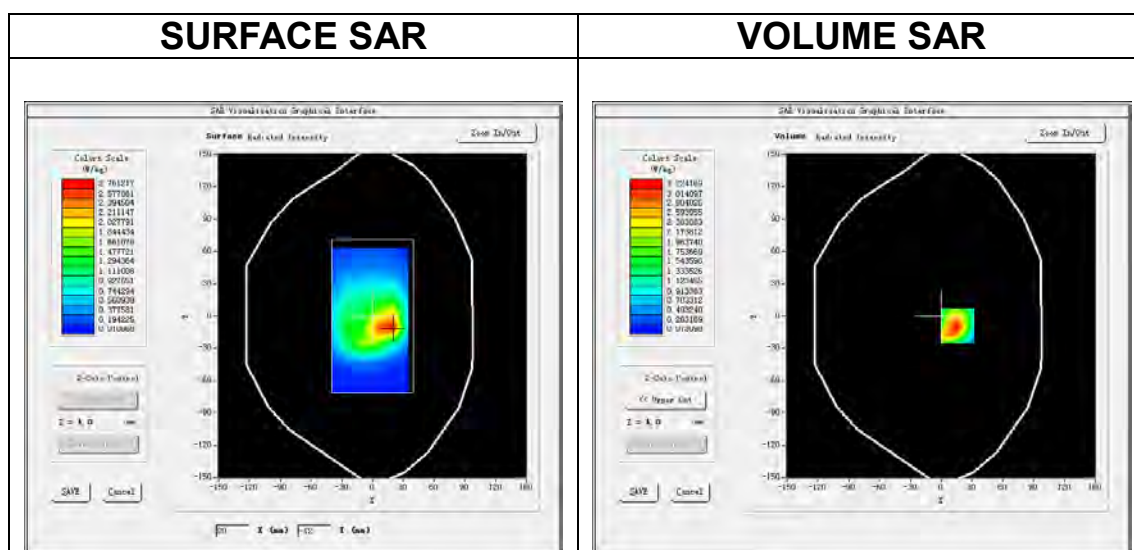

Maximum location: X=16.00, Y=-9.00

SAR Peak: 5.62 W/kg

SAR 10g (W/Kg)	1.566221
SAR 1g (W/Kg)	3.176883

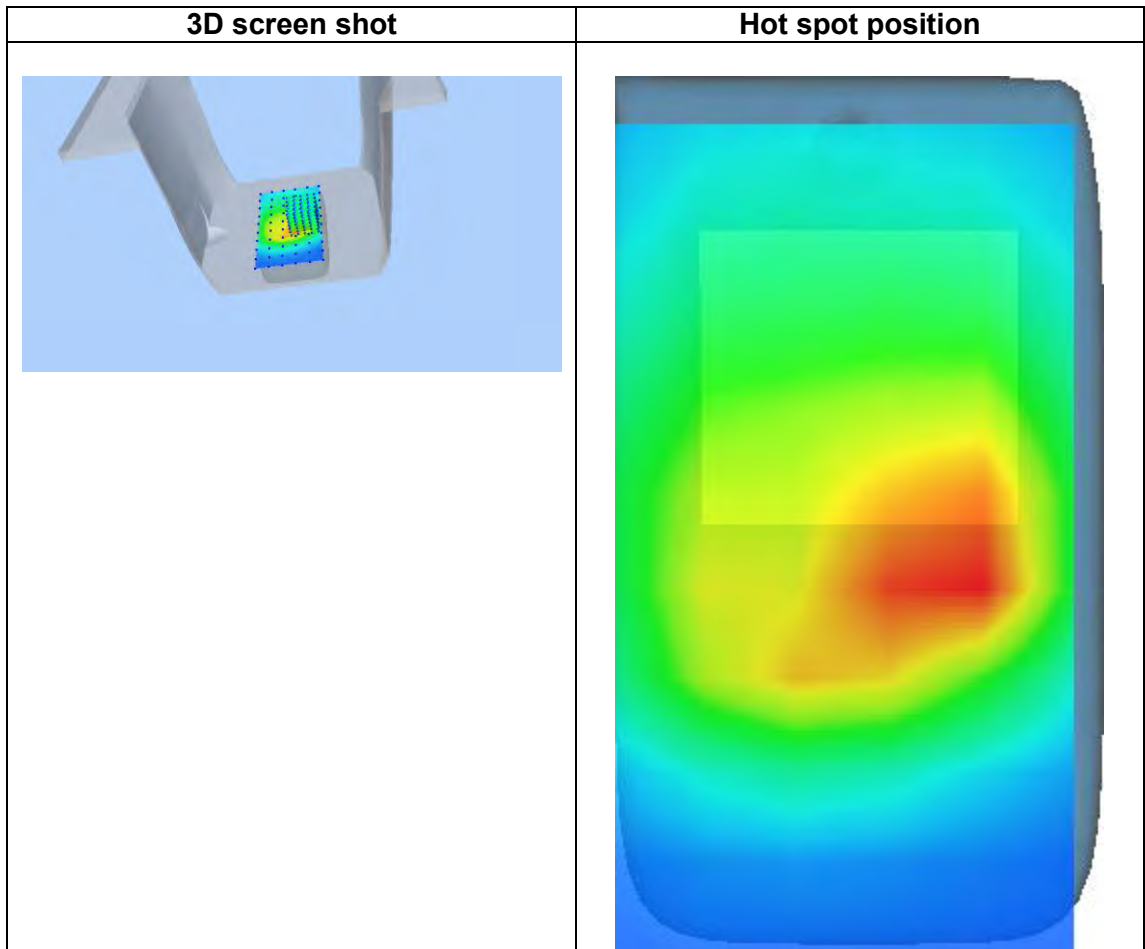
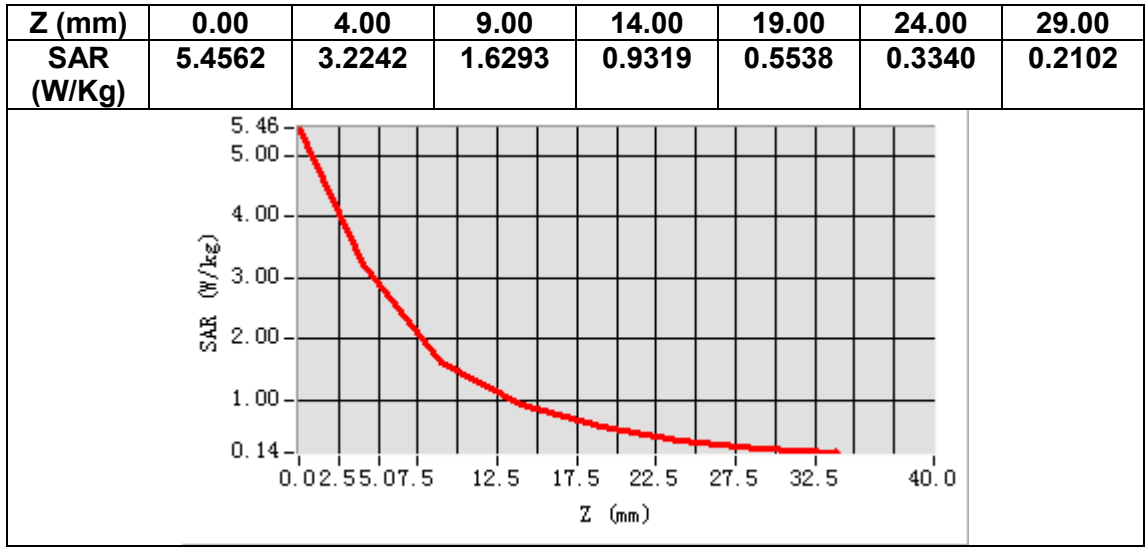

MEASUREMENT 3

Date of measurement: 26/11/2021

A. Experimental conditions.

Area Scan	<u>dx=15mm dy=15mm, h= 5.00 mm</u>
ZoomScan	<u>5x5x7, dx=8mm dy=8mm dz=5mm</u>
Phantom	<u>Left head</u>
Device Position	<u>Cheek</u>
Band	<u>GSM1800</u>
Channels	<u>Middle</u>
Signal	<u>TDMA (Crest factor: 2.0)</u>

B. SAR Measurement Results

Frequency (MHz)	1747.400000
Relative permittivity (real part)	39.494667
Relative permittivity (imaginary part)	13.996407
Conductivity (S/m)	1.358740
Variation (%)	-0.830000

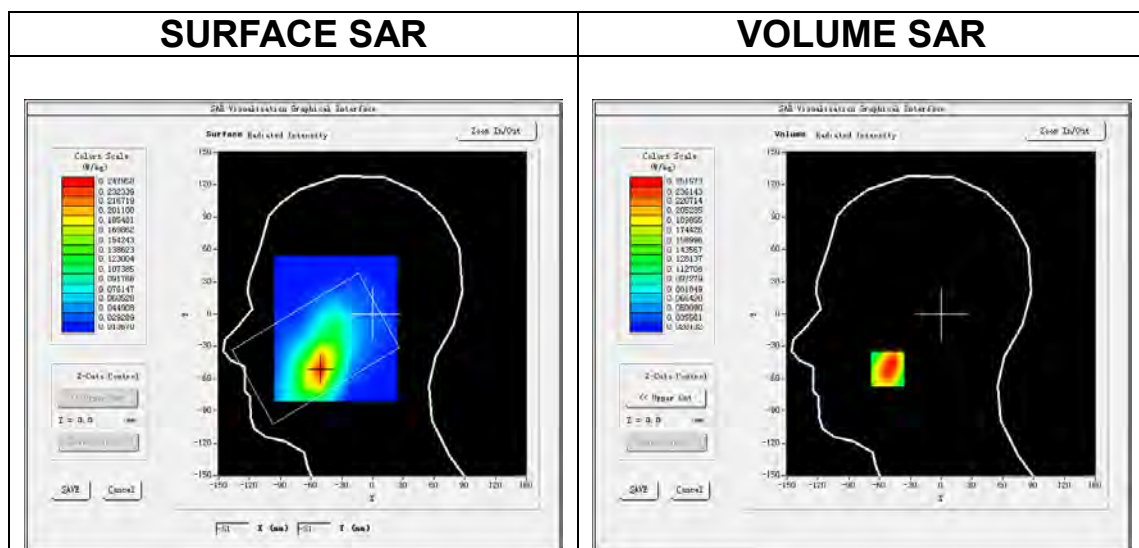

Maximum location: X=-52.00, Y=-51.00

SAR Peak: 0.37 W/kg

SAR 10g (W/Kg)	0.151753
SAR 1g (W/Kg)	0.243901

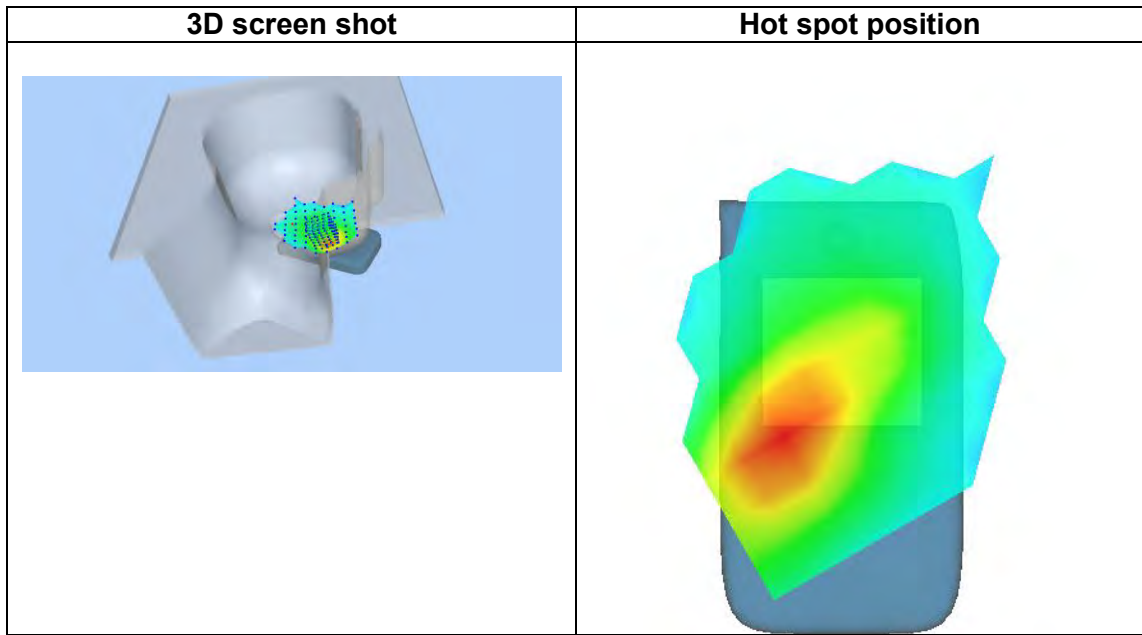
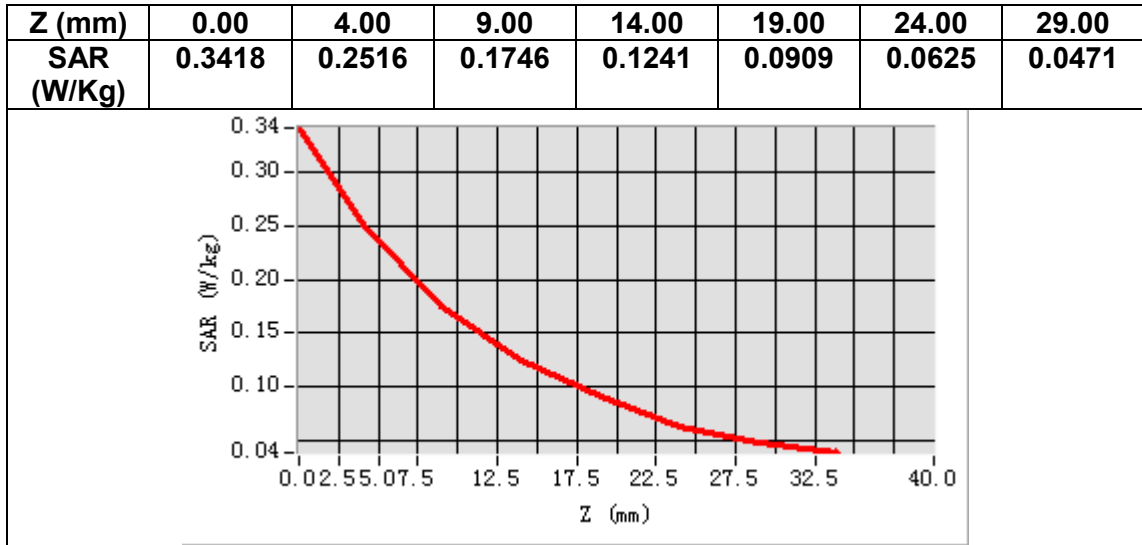

MEASUREMENT 4

Date of measurement: 26/11/2021

A. Experimental conditions.

Area Scan	<u>dx=15mm dy=15mm, h= 5.00 mm</u>
ZoomScan	<u>5x5x7, dx=8mm dy=8mm dz=5mm</u>
Phantom	<u>Validation plane</u>
Device Position	<u>Body</u>
Band	<u>GSM1800</u>
Channels	<u>Middle</u>
Signal	<u>TDMA (Crest factor: 2.0)</u>

B. SAR Measurement Results

Frequency (MHz)	1747.400000
Relative permittivity (real part)	39.494667
Relative permittivity (imaginary part)	13.996407
Conductivity (S/m)	1.358740
Variation (%)	-3.060000

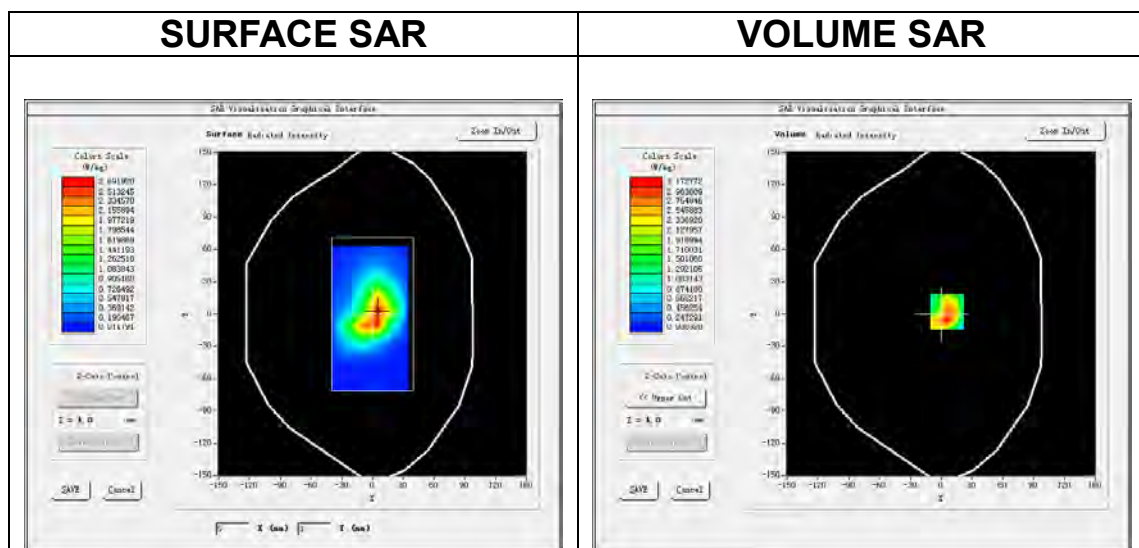

Maximum location: X=6.00, Y=2.00

SAR Peak: 5.82 W/kg

SAR 10g (W/Kg)	1.414363
SAR 1g (W/Kg)	2.998029

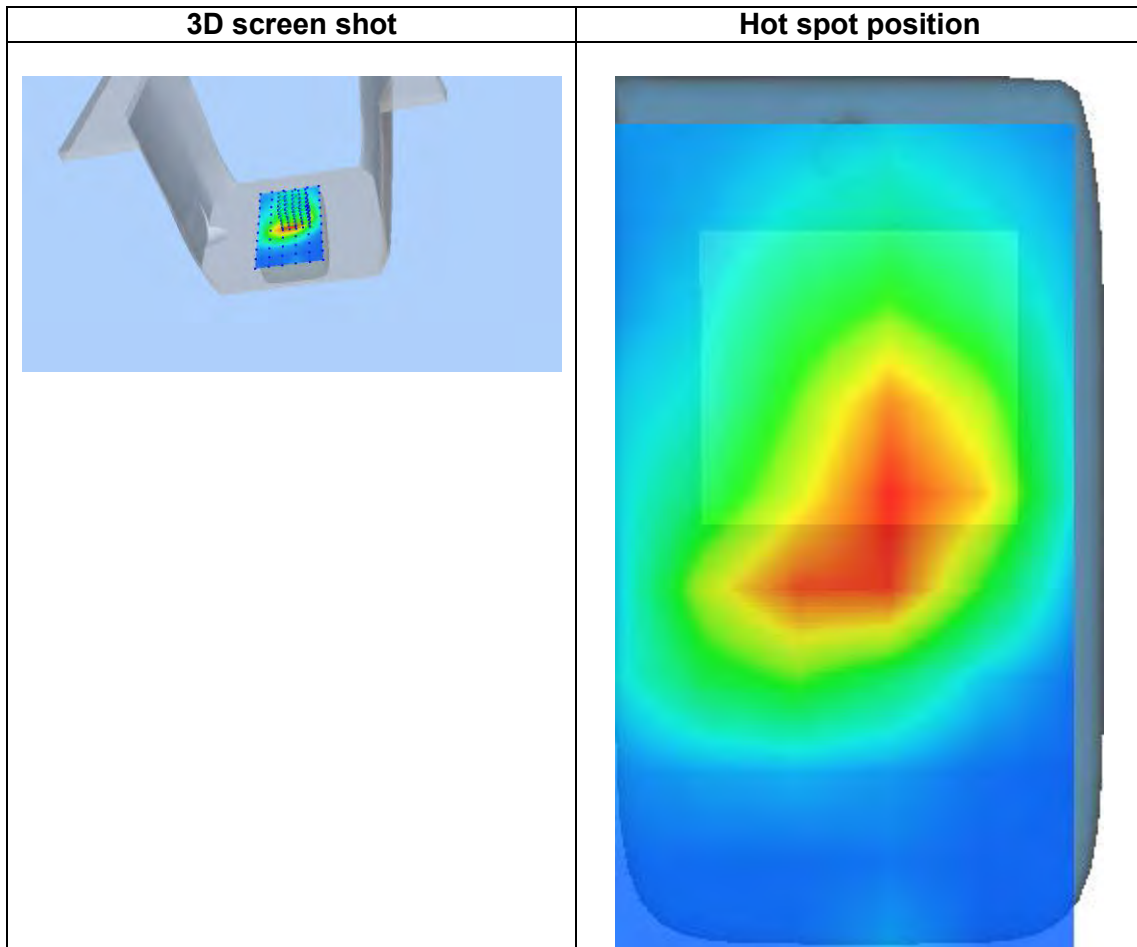
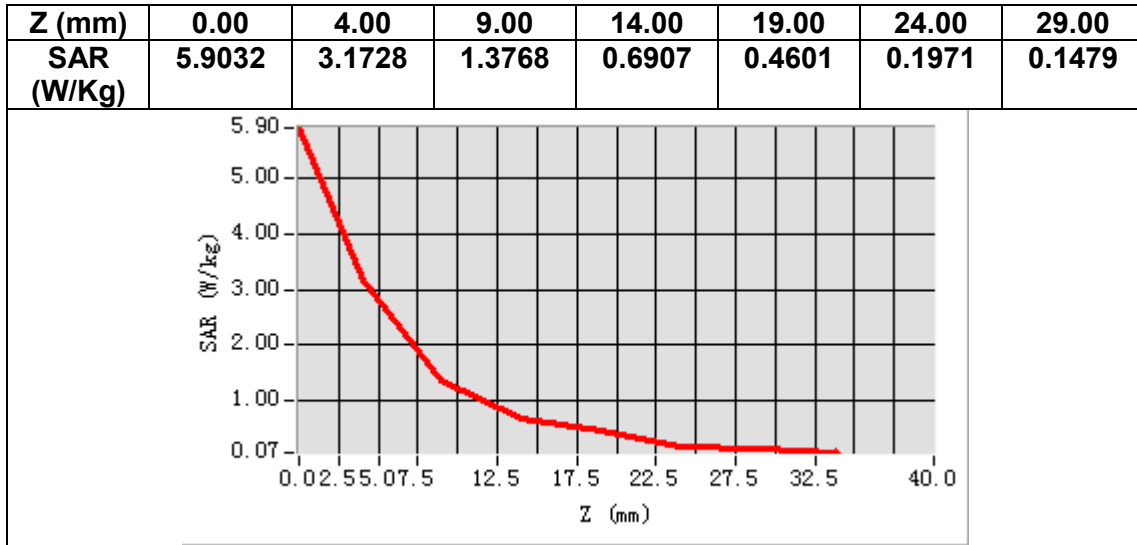

MEASUREMENT 5

Date of measurement: 22/11/2021

A. Experimental conditions.

Area Scan	<u>dx=15mm dy=15mm, h= 5.00 mm</u>
ZoomScan	<u>5x5x7, dx=8mm dy=8mm dz=5mm</u>
Phantom	<u>Left head</u>
Device Position	<u>Cheek</u>
Band	<u>Band1 UMTS</u>
Channels	<u>Middle</u>
Signal	<u>WCDMA (Crest factor: 1.0)</u>

B. SAR Measurement Results

Frequency (MHz)	1950.000000
Relative permittivity (real part)	41.409462
Relative permittivity (imaginary part)	12.680465
Conductivity (S/m)	1.373717
Variation (%)	-2.350000

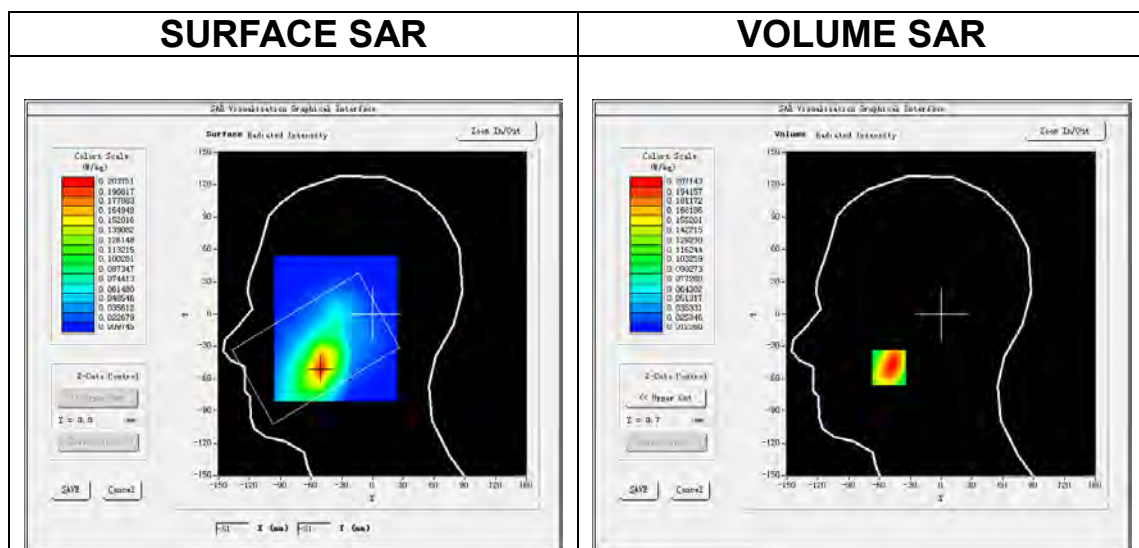

Maximum location: X=-51.00, Y=-50.00
SAR Peak: 0.31 W/kg

SAR 10g (W/Kg)	0.119981
SAR 1g (W/Kg)	0.201941

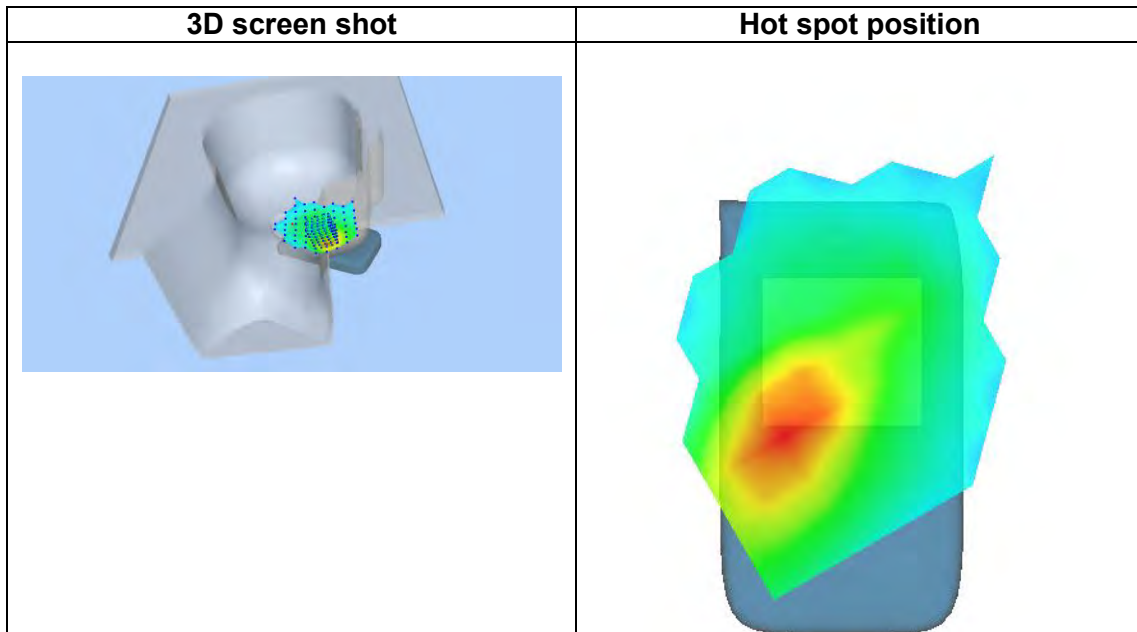
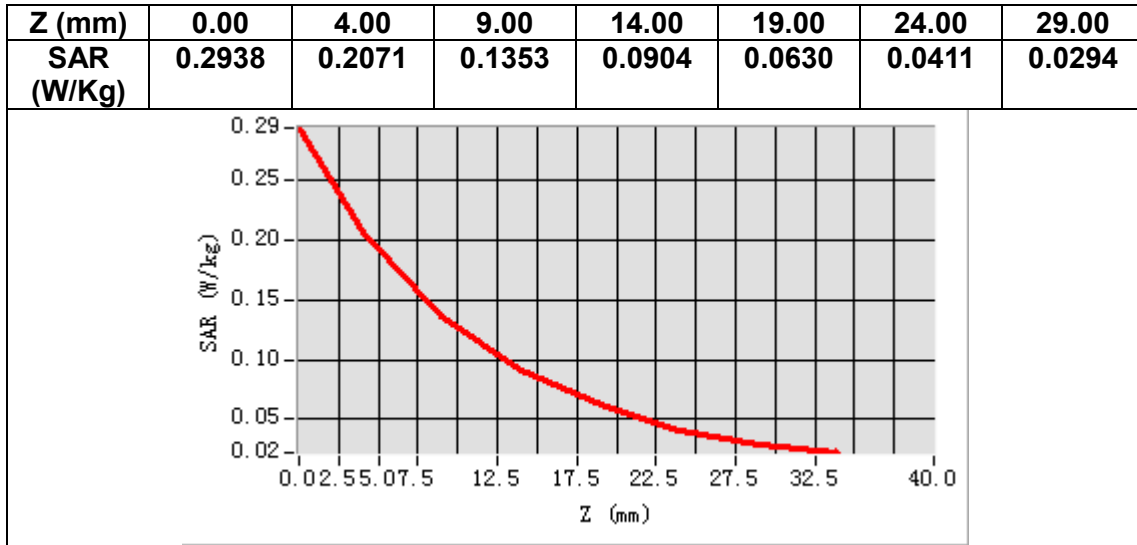

MEASUREMENT 6

Date of measurement: 22/11/2021

A. Experimental conditions.

Area Scan	<u>dx=15mm dy=15mm, h= 5.00 mm</u>
ZoomScan	<u>5x5x7, dx=8mm dy=8mm dz=5mm</u>
Phantom	<u>Validation plane</u>
Device Position	<u>Body</u>
Band	<u>Band1 UMTS</u>
Channels	<u>Middle</u>
Signal	<u>WCDMA (Crest factor: 1.0)</u>

B. SAR Measurement Results

Frequency (MHz)	1950.000000
Relative permittivity (real part)	41.409462
Relative permittivity (imaginary part)	12.680465
Conductivity (S/m)	1.373717
Variation (%)	-1.060000

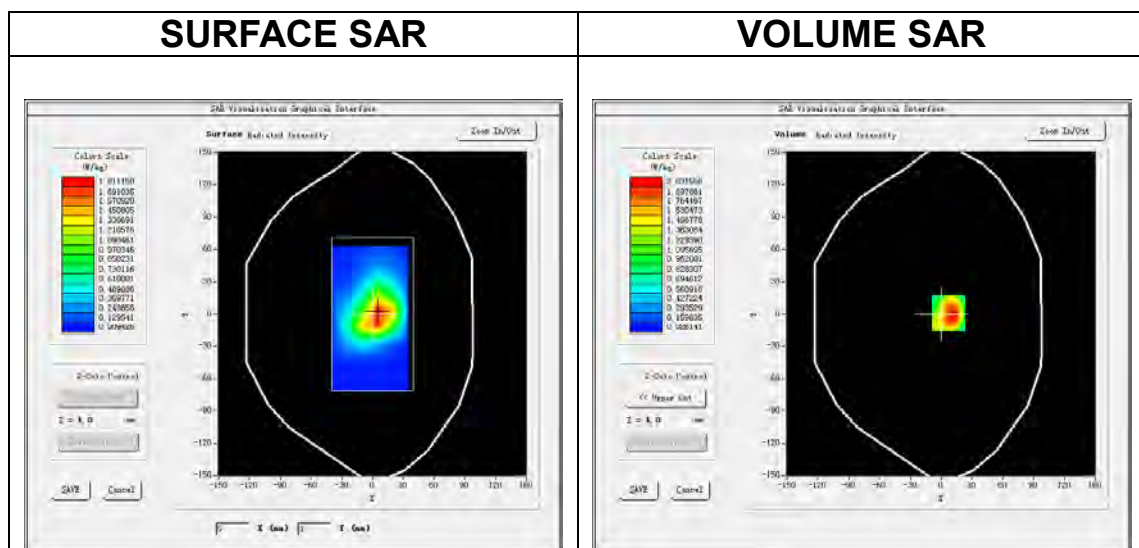

Maximum location: X=7.00, Y=1.00

SAR Peak: 3.89 W/kg

SAR 10g (W/Kg)	0.985319
SAR 1g (W/Kg)	2.061825

Z (mm)	0.00	4.00	9.00	14.00	19.00	24.00	29.00
SAR (W/Kg)	3.9421	2.0316	0.7817	0.5163	0.2365	0.1415	0.0748

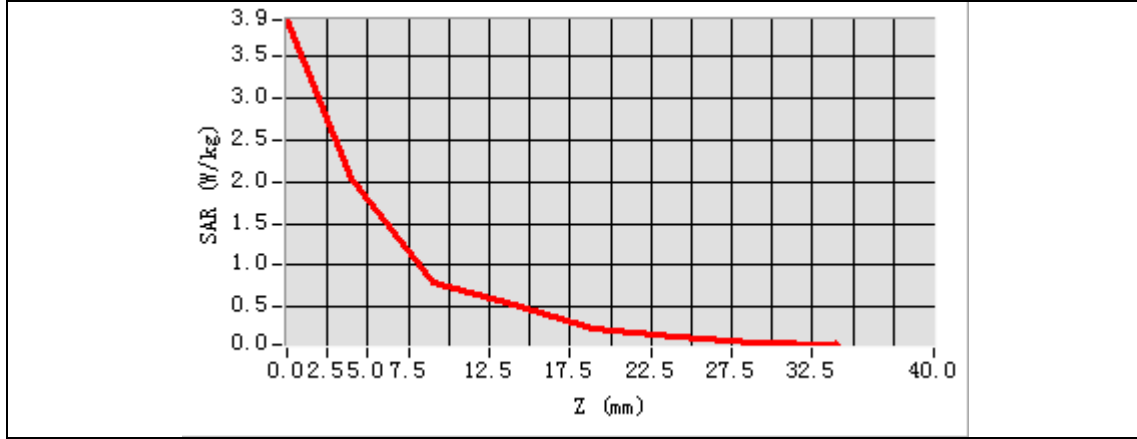

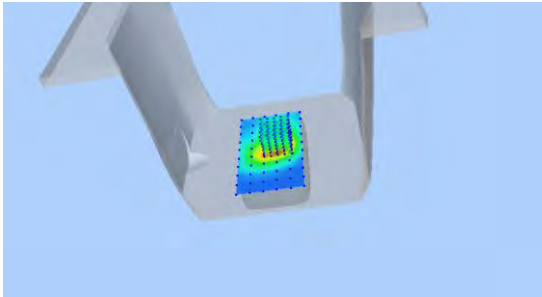
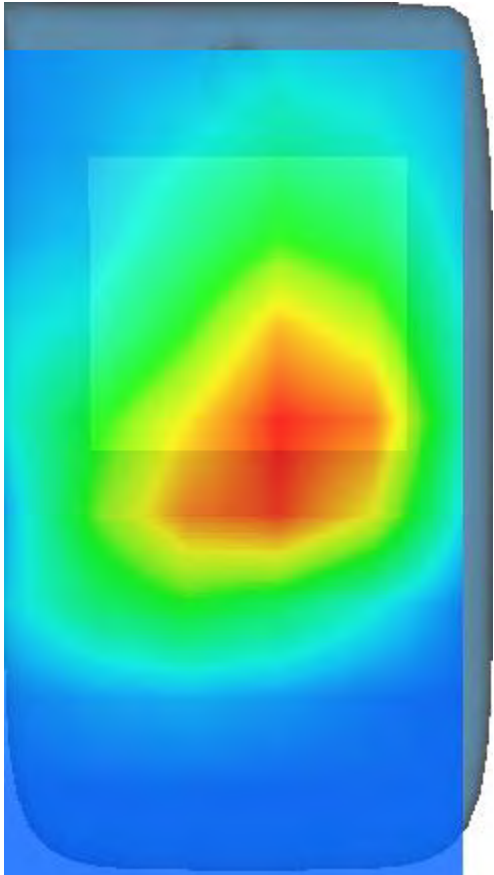
3D screen shot	Hot spot position
	

MEASUREMENT 7

Date of measurement: 29/11/2021

A. Experimental conditions.

Area Scan	<u>dx=15mm dy=15mm, h= 5.00 mm</u>
ZoomScan	<u>5x5x7, dx=8mm dy=8mm dz=5mm</u>
Phantom	<u>Left head</u>
Device Position	<u>Cheek</u>
Band	<u>Band8 WCDMA900</u>
Channels	<u>Middle</u>
Signal	<u>WCDMA (Crest factor: 1.0)</u>

B. SAR Measurement Results

Frequency (MHz)	897.600000
Relative permittivity (real part)	42.187134
Relative permittivity (imaginary part)	20.100006
Conductivity (S/m)	1.002320
Variation (%)	-1.480000

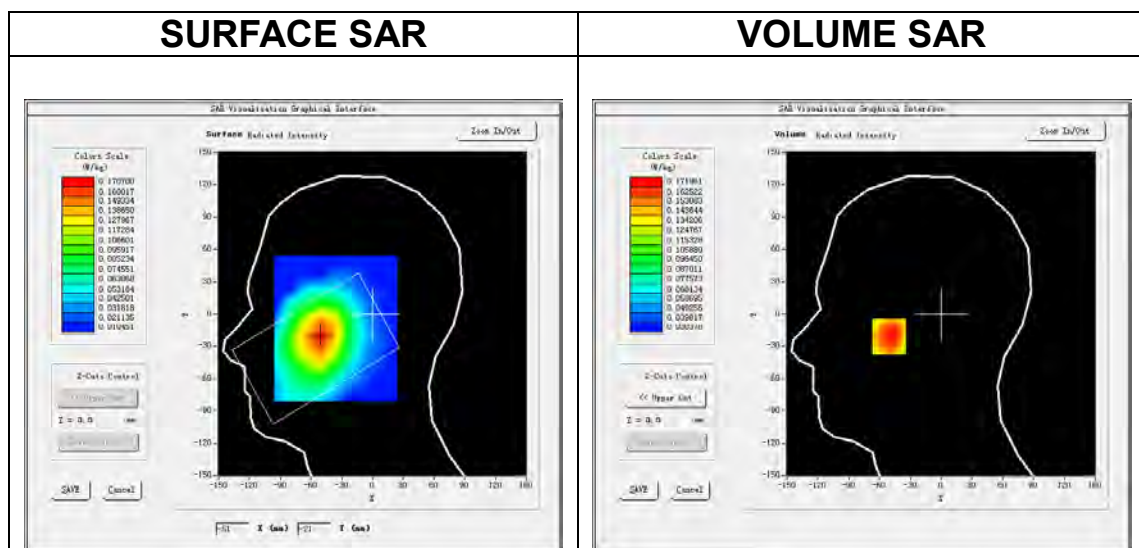

Maximum location: X=-51.00, Y=-21.00
SAR Peak: 0.21 W/kg

SAR 10g (W/Kg)	0.128270
SAR 1g (W/Kg)	0.170844

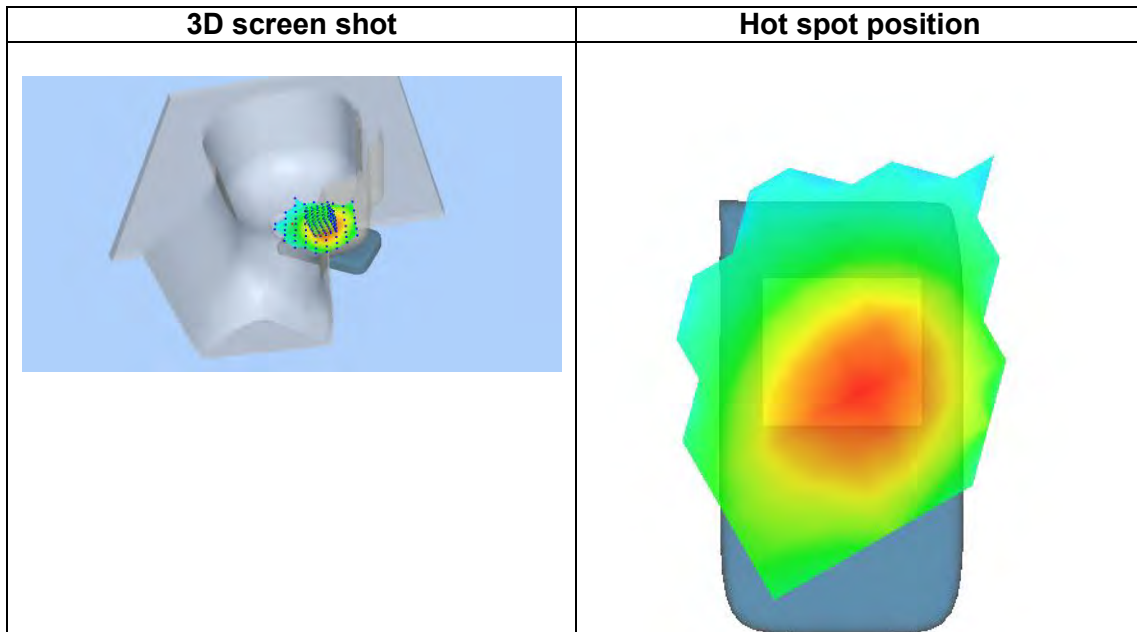
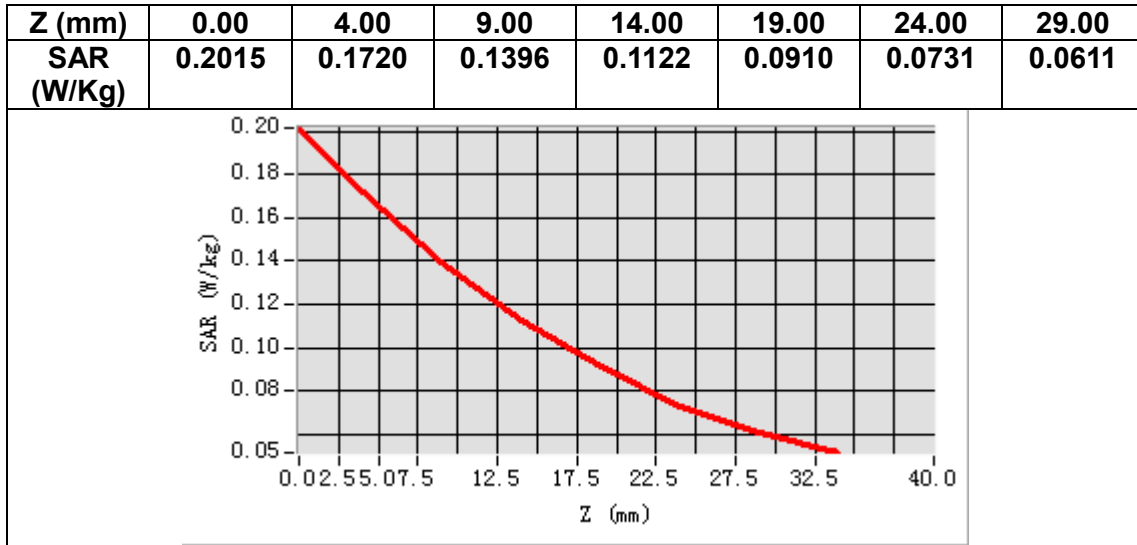

MEASUREMENT 8

Date of measurement: 29/11/2021

A. Experimental conditions.

Area Scan	<u>dx=15mm dy=15mm, h= 5.00 mm</u>
ZoomScan	<u>5x5x7, dx=8mm dy=8mm dz=5mm</u>
Phantom	<u>Validation plane</u>
Device Position	<u>Body</u>
Band	<u>Band8 WCDMA900</u>
Channels	<u>Middle</u>
Signal	<u>WCDMA (Crest factor: 1.0)</u>

B. SAR Measurement Results

Frequency (MHz)	897.600000
Relative permittivity (real part)	42.187134
Relative permittivity (imaginary part)	20.100006
Conductivity (S/m)	1.002320
Variation (%)	-0.500000

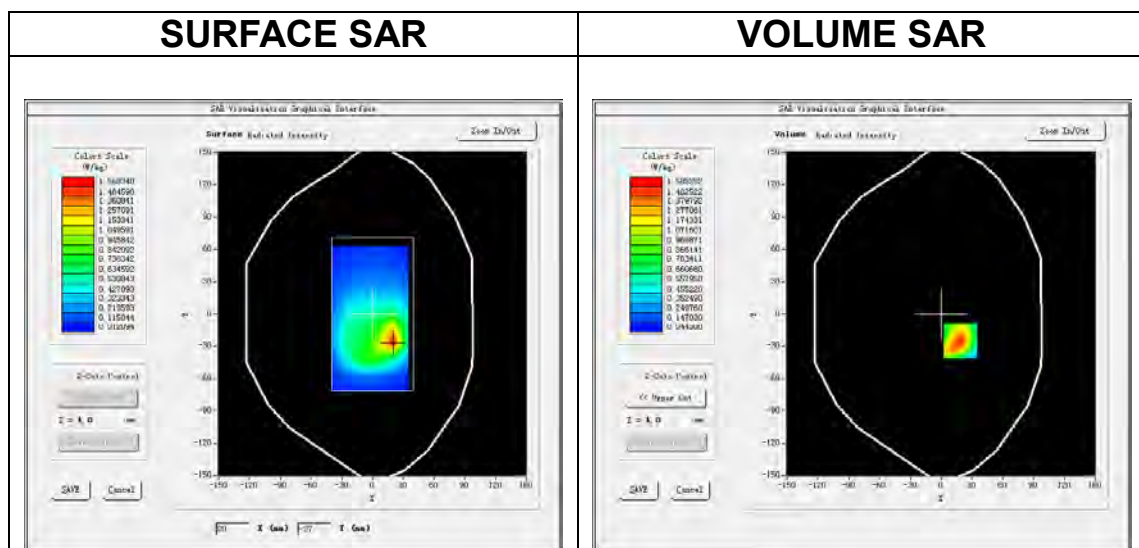

Maximum location: X=19.00, Y=-25.00
SAR Peak: 2.58 W/kg

SAR 10g (W/Kg)	0.793645
SAR 1g (W/Kg)	1.524398

Z (mm)	0.00	4.00	9.00	14.00	19.00	24.00	29.00
SAR (W/Kg)	2.5654	1.5853	0.8522	0.4903	0.2930	0.1838	0.1176

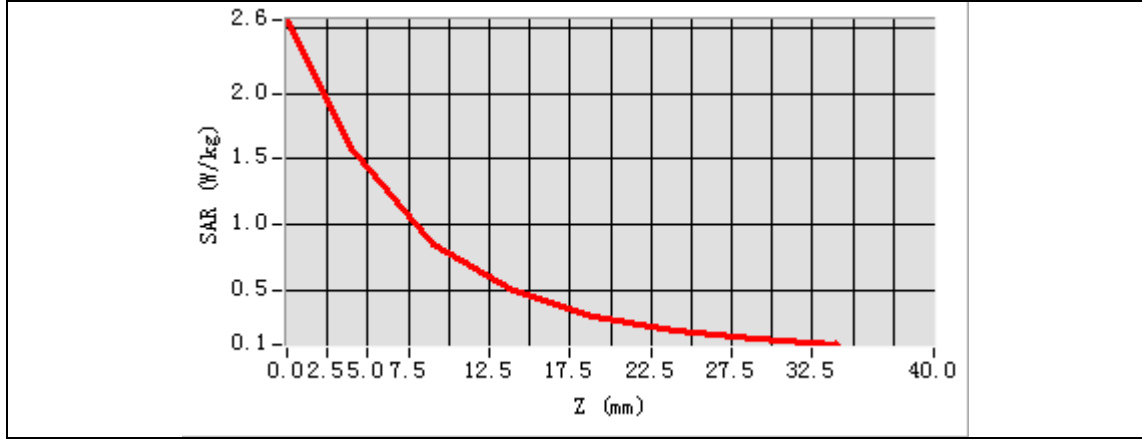

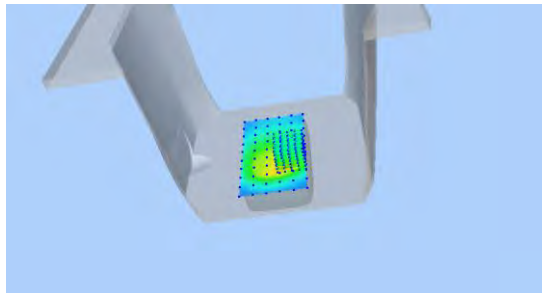
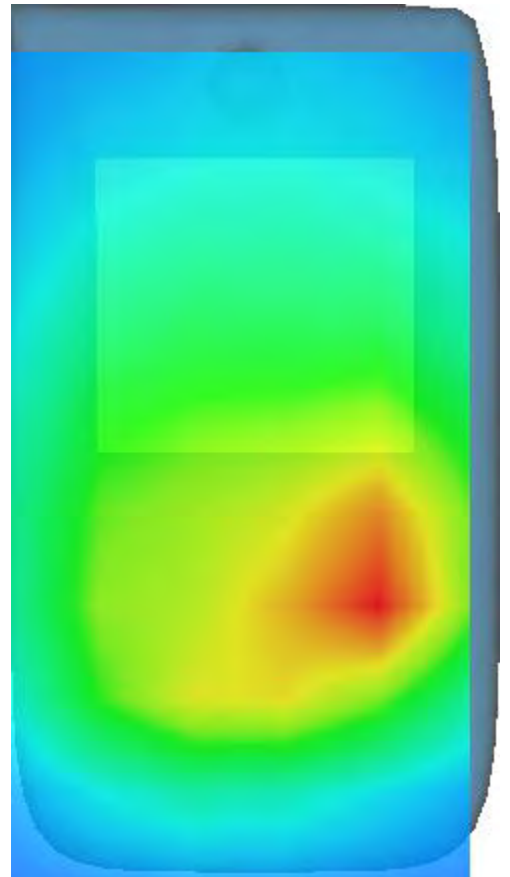
3D screen shot	Hot spot position
	

MEASUREMENT 9

Date of measurement: 27/11/2021

A. Experimental conditions.

Area Scan	<u>dx=12mm dy=12mm, h= 5.00 mm</u>
ZoomScan	<u>7x7x7,dx=5mm dy=5mm dz=5mm</u>
Phantom	<u>Left head</u>
Device Position	<u>Cheek</u>
Band	<u>IEEE 802.11b ISM</u>
Channels	<u>Middle</u>
Signal	<u>IEEE802.11b (Crest factor: 1.0)</u>

B. SAR Measurement Results

Frequency (MHz)	2442.000000
Relative permittivity (real part)	40.583450
Relative permittivity (imaginary part)	13.172354
Conductivity (S/m)	1.787049
Variation (%)	-1.260000

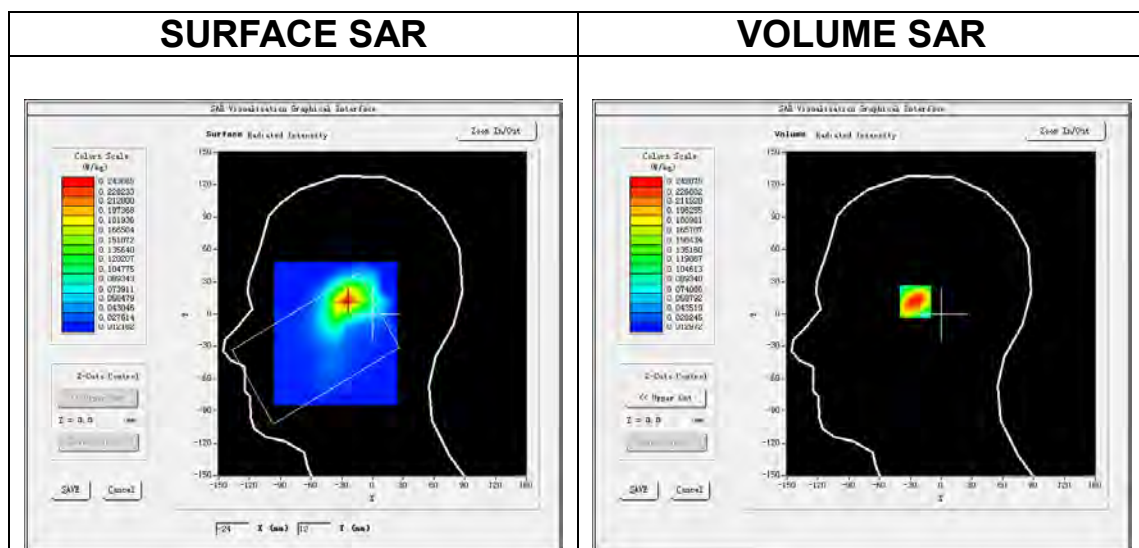

Maximum location: X=-24.00, Y=13.00
SAR Peak: 0.38 W/kg

SAR 10g (W/Kg)	0.119715
SAR 1g (W/Kg)	0.226366

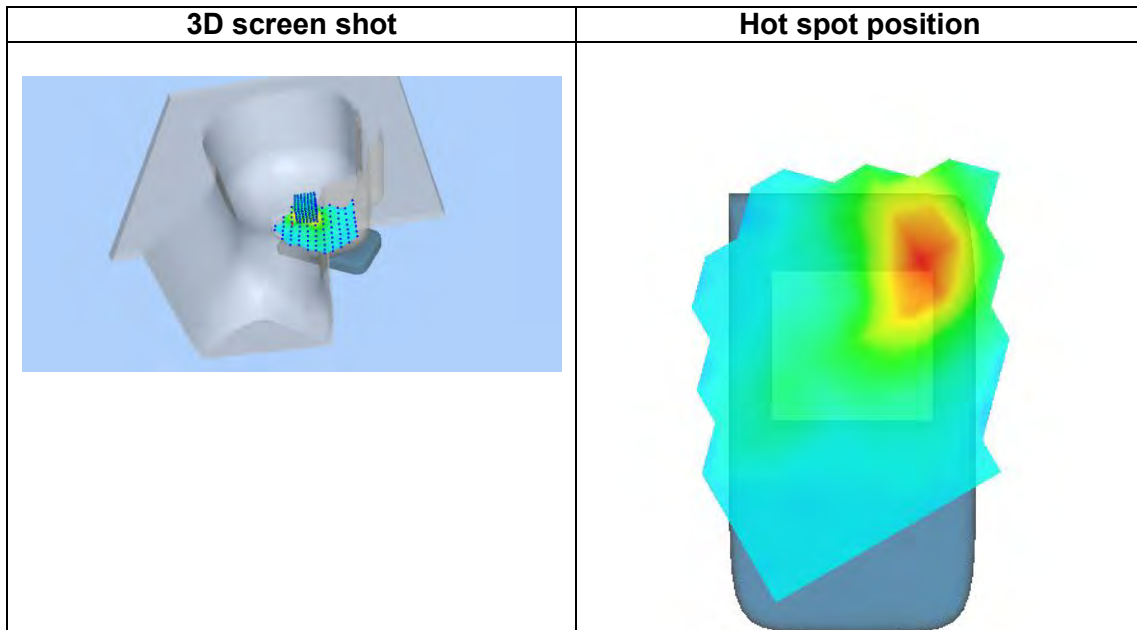
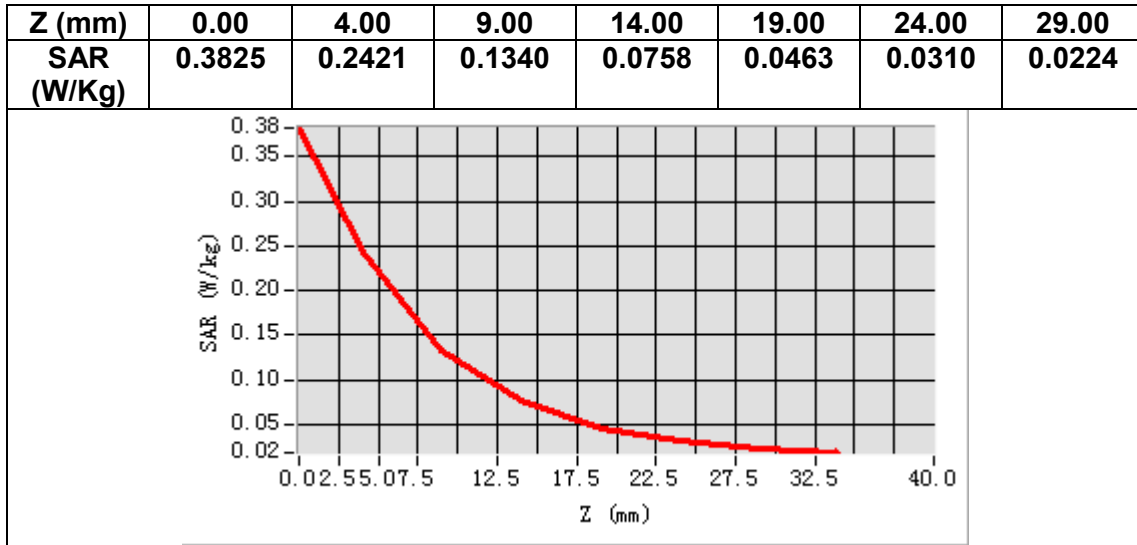

MEASUREMENT 10

Date of measurement: 27/11/2021

A. Experimental conditions.

Area Scan	<u>dx=12mm dy=12mm, h= 5.00 mm</u>
ZoomScan	<u>7x7x7, dx=5mm dy=5mm dz=5mm</u>
Phantom	<u>Validation plane</u>
Device Position	<u>Body</u>
Band	<u>IEEE 802.11b ISM</u>
Channels	<u>Middle</u>
Signal	<u>IEEE802.11b (Crest factor: 1.0)</u>

B. SAR Measurement Results

Frequency (MHz)	2442.000000
Relative permittivity (real part)	40.583450
Relative permittivity (imaginary part)	13.172354
Conductivity (S/m)	1.787049
Variation (%)	-2.610000

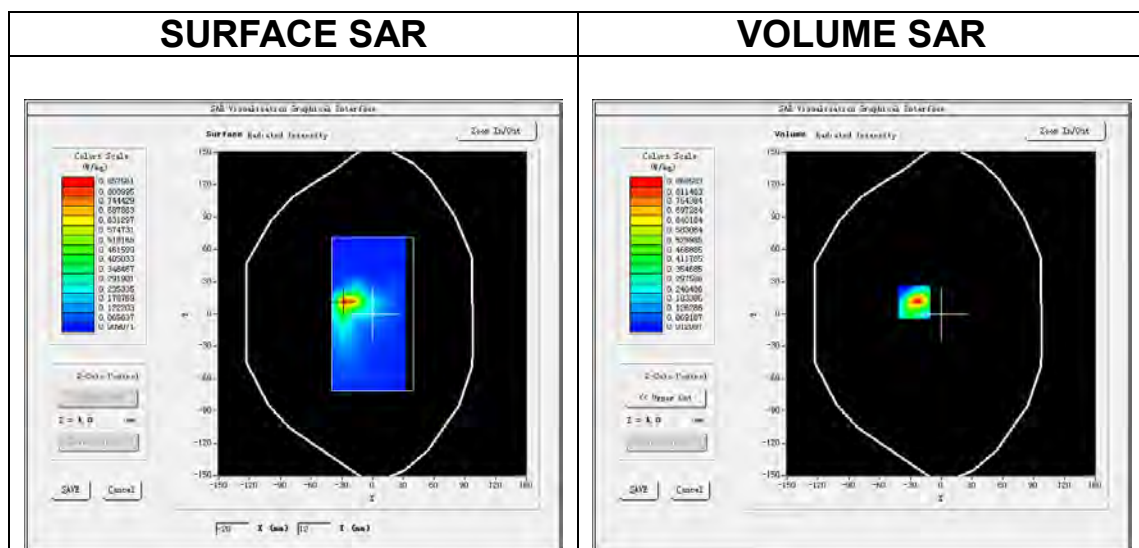

Maximum location: X=-26.00, Y=11.00
SAR Peak: 1.60 W/kg

SAR 10g (W/Kg)	0.465169
SAR 1g (W/Kg)	0.767148

Z (mm)	0.00	4.00	9.00	14.00	19.00	24.00	29.00
SAR (W/Kg)	1.5920	0.8686	0.3732	0.1663	0.0862	0.0466	0.0283

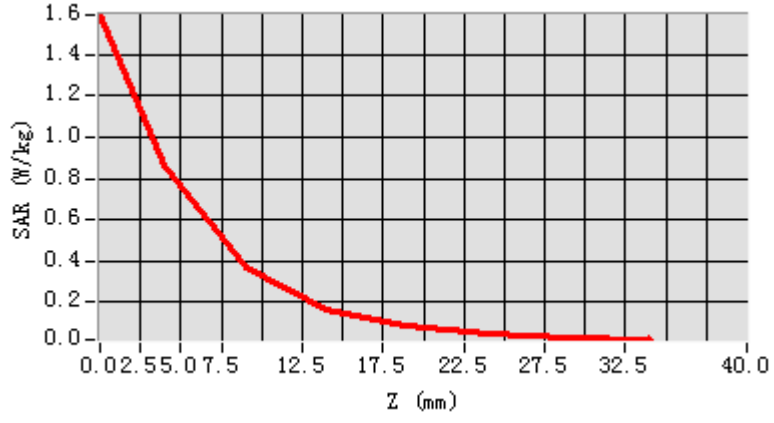

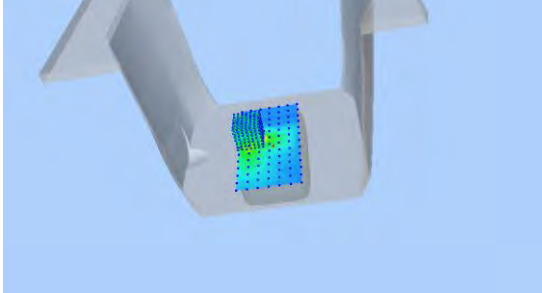
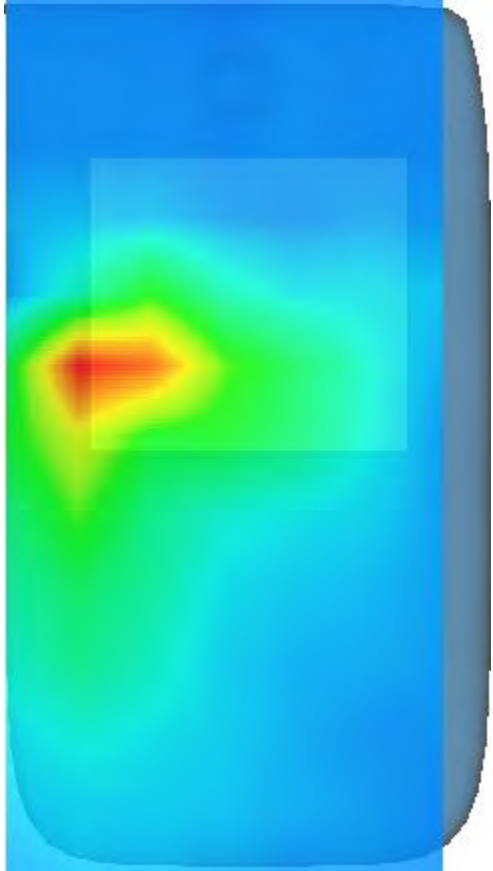
3D screen shot	Hot spot position
	

MEASUREMENT 11

Date of measurement: 22/11/2021

A. Experimental conditions.

Area Scan	<u>dx=15mm dy=15mm, h= 5.00 mm</u>
ZoomScan	<u>5x5x7, dx=8mm dy=8mm dz=5mm</u>
Phantom	<u>Left head</u>
Device Position	<u>Cheek</u>
Band	<u>LTE band 1</u>
Channels	<u>Middle</u>
Signal	<u>LTE (Crest factor: 1.0)</u>

B. SAR Measurement Results

Frequency (MHz)	1950.000000
Relative permittivity (real part)	41.409462
Relative permittivity (imaginary part)	12.680465
Conductivity (S/m)	1.373717
Variation (%)	-3.900000

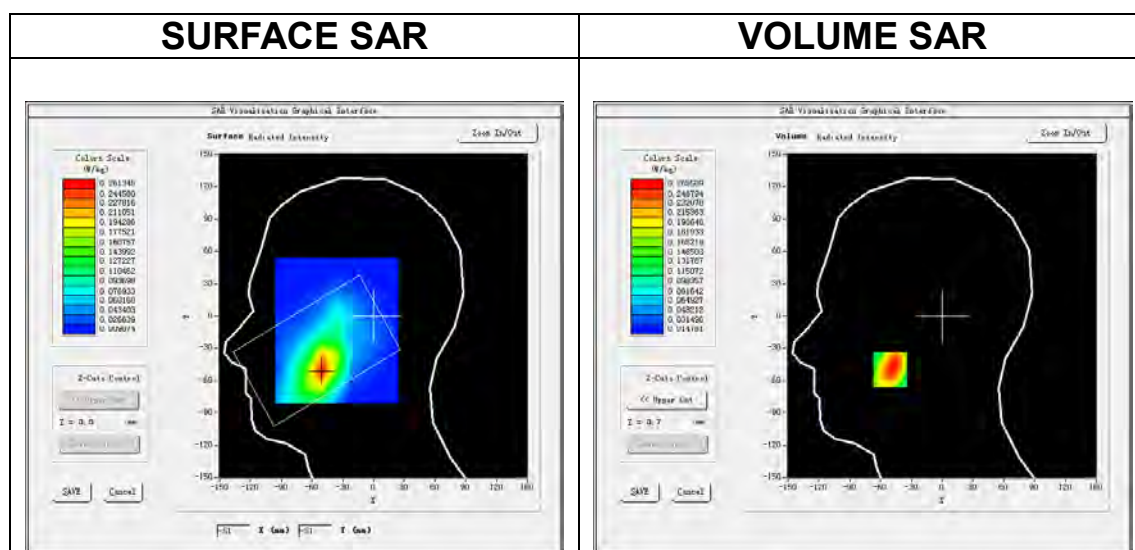

Maximum location: X=-51.00, Y=-50.00
SAR Peak: 0.39 W/kg

SAR 10g (W/Kg)	0.153313
SAR 1g (W/Kg)	0.256780

Z (mm)	0.00	4.00	9.00	14.00	19.00	24.00	29.00
SAR (W/Kg)	0.3688	0.2655	0.1771	0.1172	0.0796	0.0556	0.0370

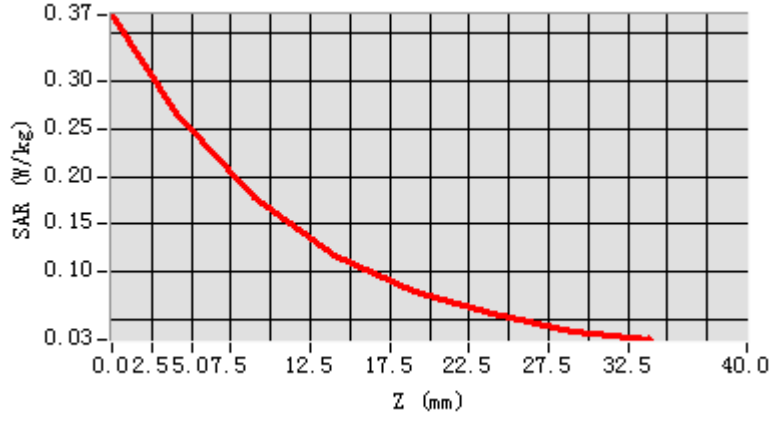

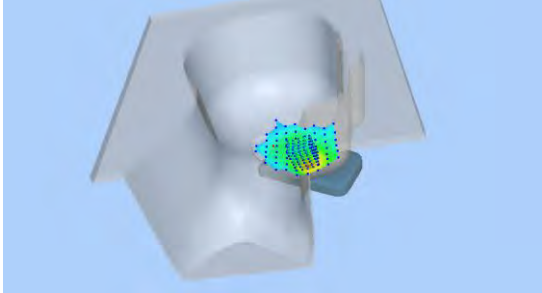
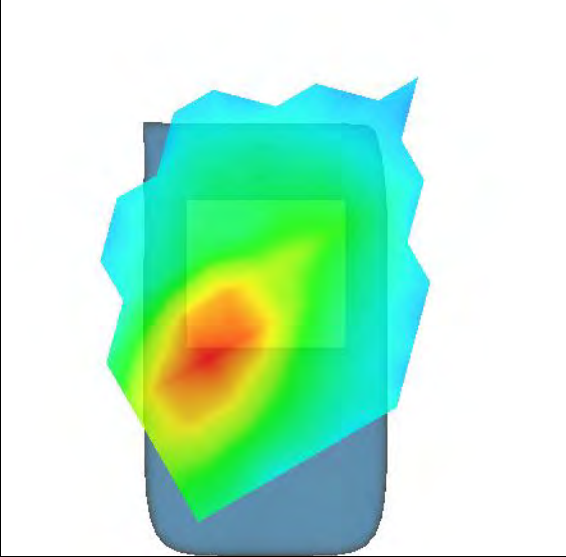
3D screen shot	Hot spot position
	

MEASUREMENT 12

Date of measurement: 22/11/2021

A. Experimental conditions.

Area Scan	<u>dx=15mm dy=15mm, h= 5.00 mm</u>
ZoomScan	<u>5x5x7, dx=8mm dy=8mm dz=5mm</u>
Phantom	<u>Validation plane</u>
Device Position	<u>Body</u>
Band	<u>LTE band 1</u>
Channels	<u>Middle</u>
Signal	<u>LTE (Crest factor: 1.0)</u>

B. SAR Measurement Results

Frequency (MHz)	1950.000000
Relative permittivity (real part)	41.409462
Relative permittivity (imaginary part)	12.680465
Conductivity (S/m)	1.373717
Variation (%)	-1.400000

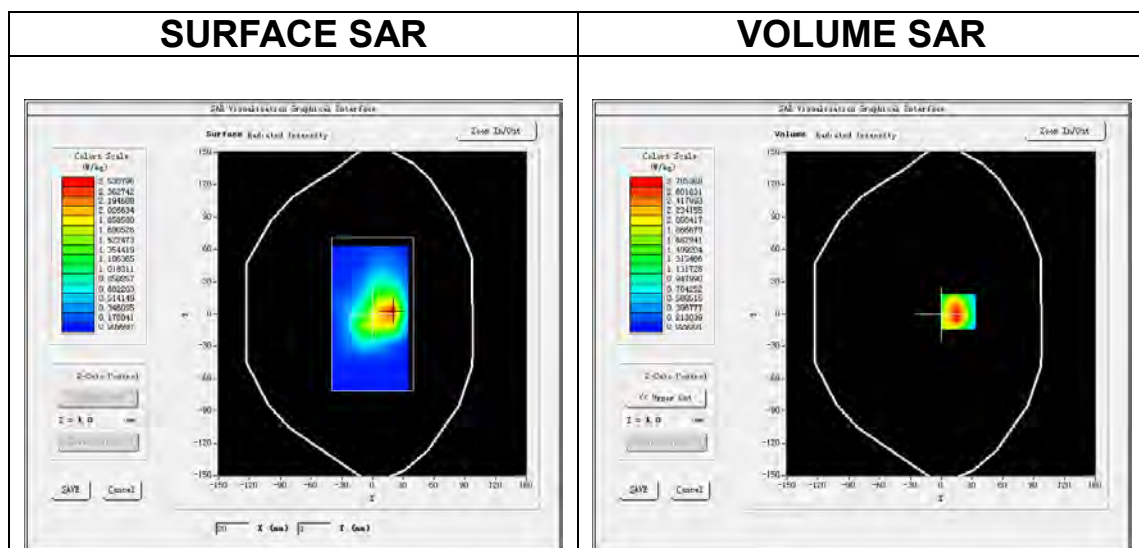

Maximum location: X=17.00, Y=2.00

SAR Peak: 4.99 W/kg

SAR 10g (W/Kg)	1.307110
SAR 1g (W/Kg)	2.680969

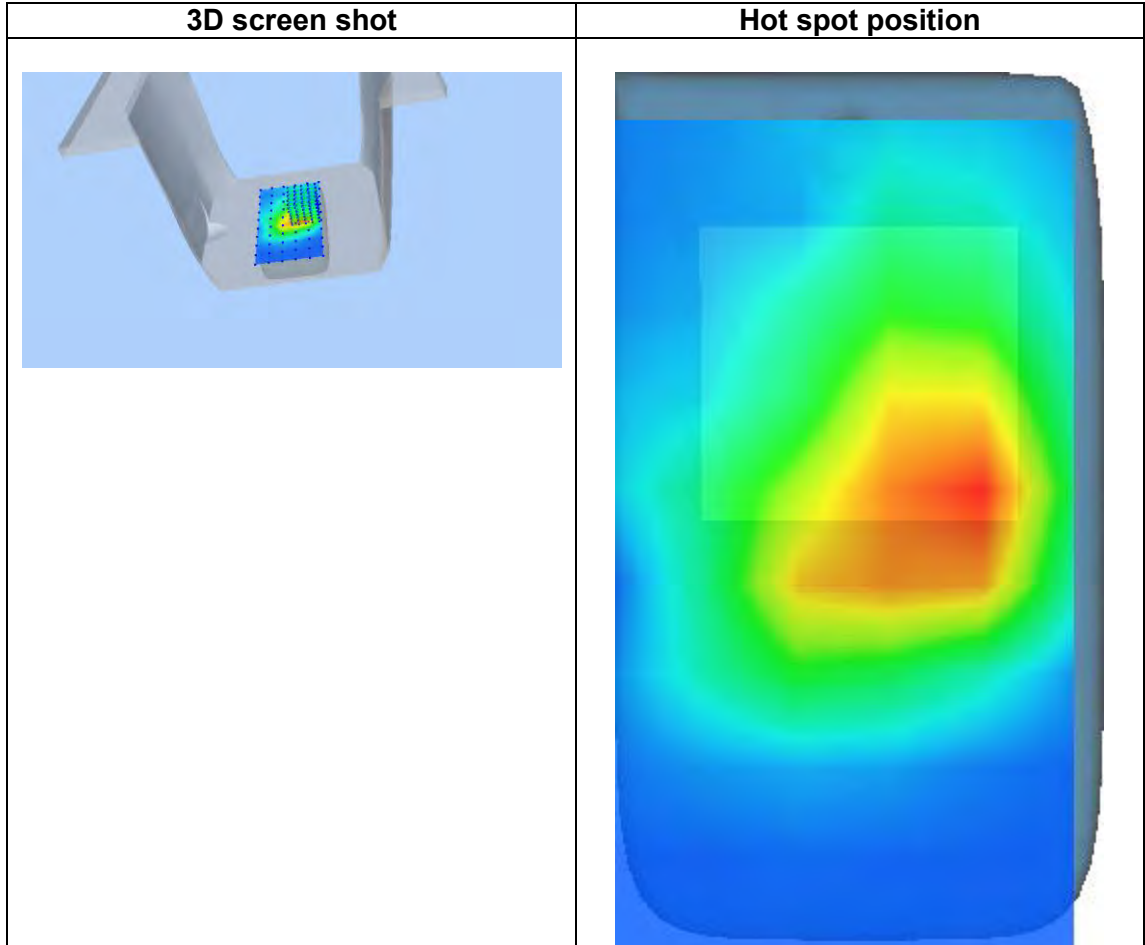
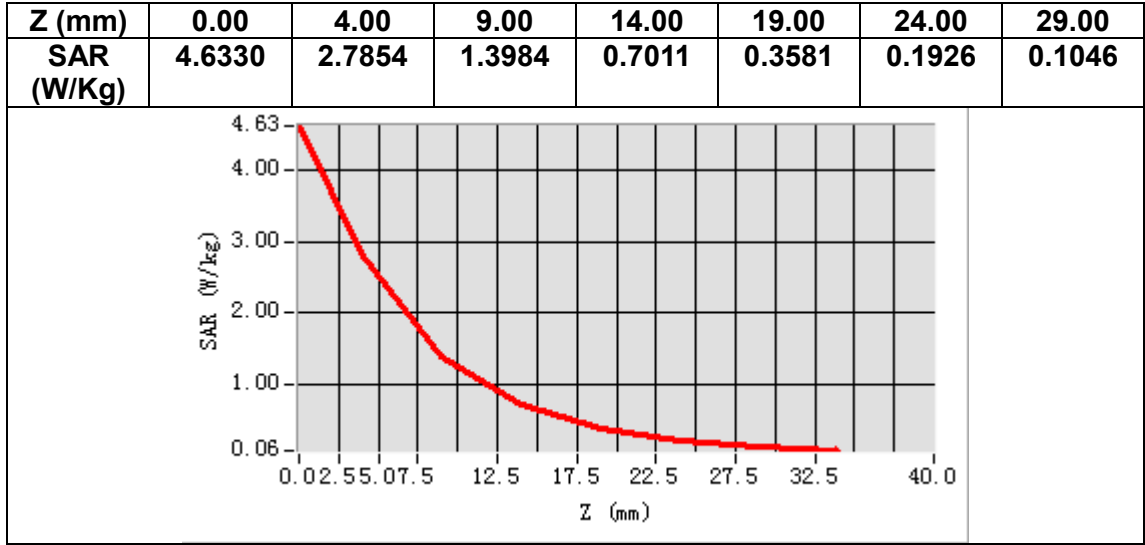

MEASUREMENT 13

Date of measurement: 26/11/2021

A. Experimental conditions.

Area Scan	<u>dx=15mm dy=15mm, h= 5.00 mm</u>
ZoomScan	<u>5x5x7, dx=8mm dy=8mm dz=5mm</u>
Phantom	<u>Left head</u>
Device Position	<u>Cheek</u>
Band	<u>LTE band 3</u>
Channels	<u>Middle</u>
Signal	<u>LTE (Crest factor: 1.0)</u>

B. SAR Measurement Results

Frequency (MHz)	1747.500000
Relative permittivity (real part)	39.494106
Relative permittivity (imaginary part)	13.994927
Conductivity (S/m)	1.358285
Variation (%)	1.990000

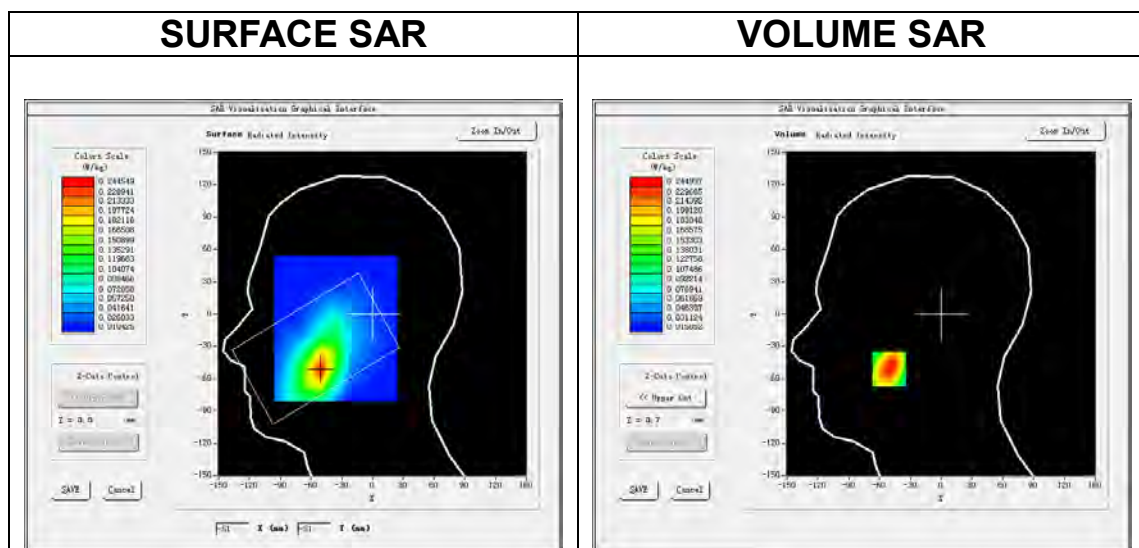

Maximum location: X=-51.00, Y=-51.00

SAR Peak: 0.33 W/kg

SAR 10g (W/Kg)	0.148242
SAR 1g (W/Kg)	0.234574

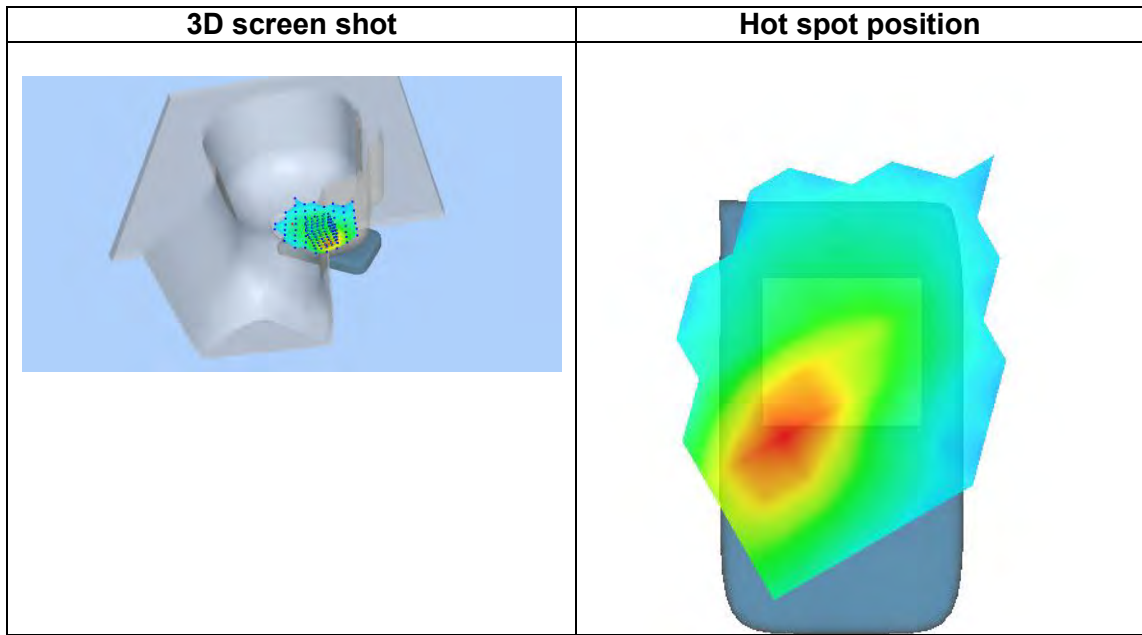
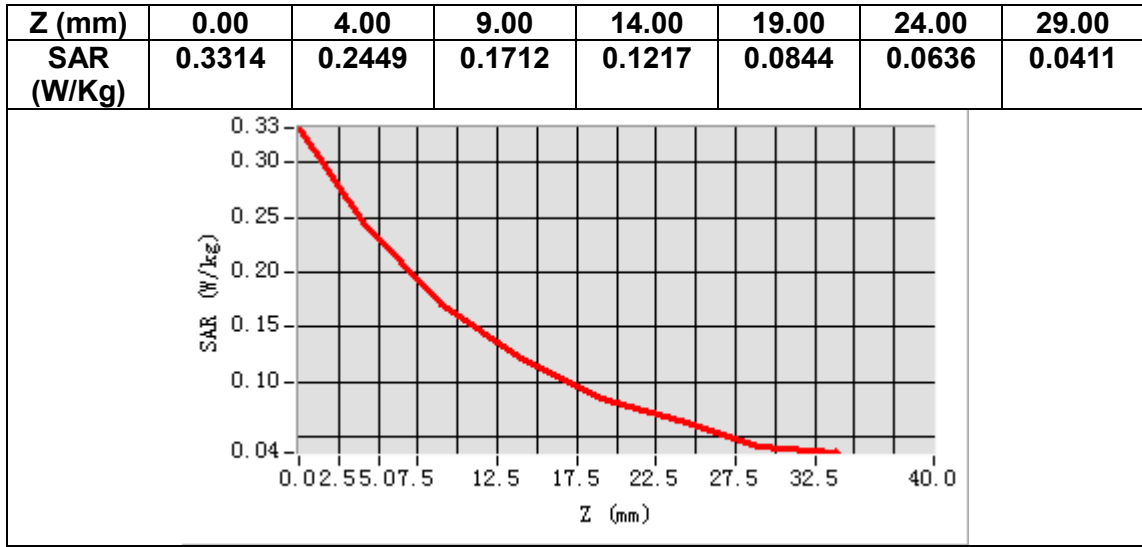

MEASUREMENT 14

Date of measurement: 26/11/2021

A. Experimental conditions.

Area Scan	<u>dx=15mm dy=15mm, h= 5.00 mm</u>
ZoomScan	<u>5x5x7, dx=8mm dy=8mm dz=5mm</u>
Phantom	<u>Validation plane</u>
Device Position	<u>Body</u>
Band	<u>LTE band 3</u>
Channels	<u>Middle</u>
Signal	<u>LTE (Crest factor: 1.0)</u>

B. SAR Measurement Results

Frequency (MHz)	1747.500000
Relative permittivity (real part)	39.494106
Relative permittivity (imaginary part)	13.994927
Conductivity (S/m)	1.358285
Variation (%)	-2.560000

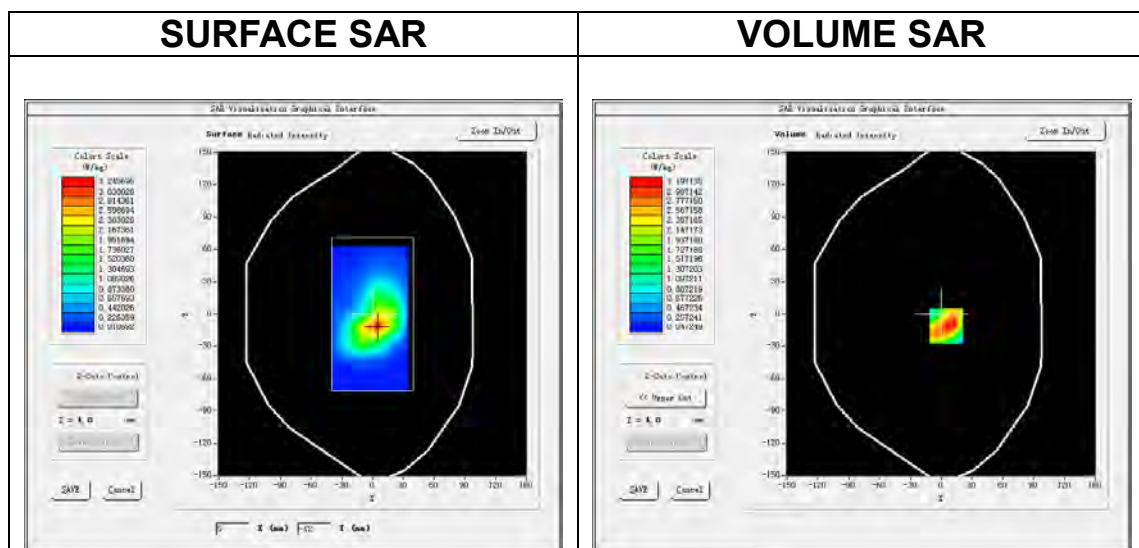

Maximum location: X=5.00, Y=-11.00

SAR Peak: 5.89 W/kg

SAR 10g (W/Kg)	1.547385
SAR 1g (W/Kg)	3.131116

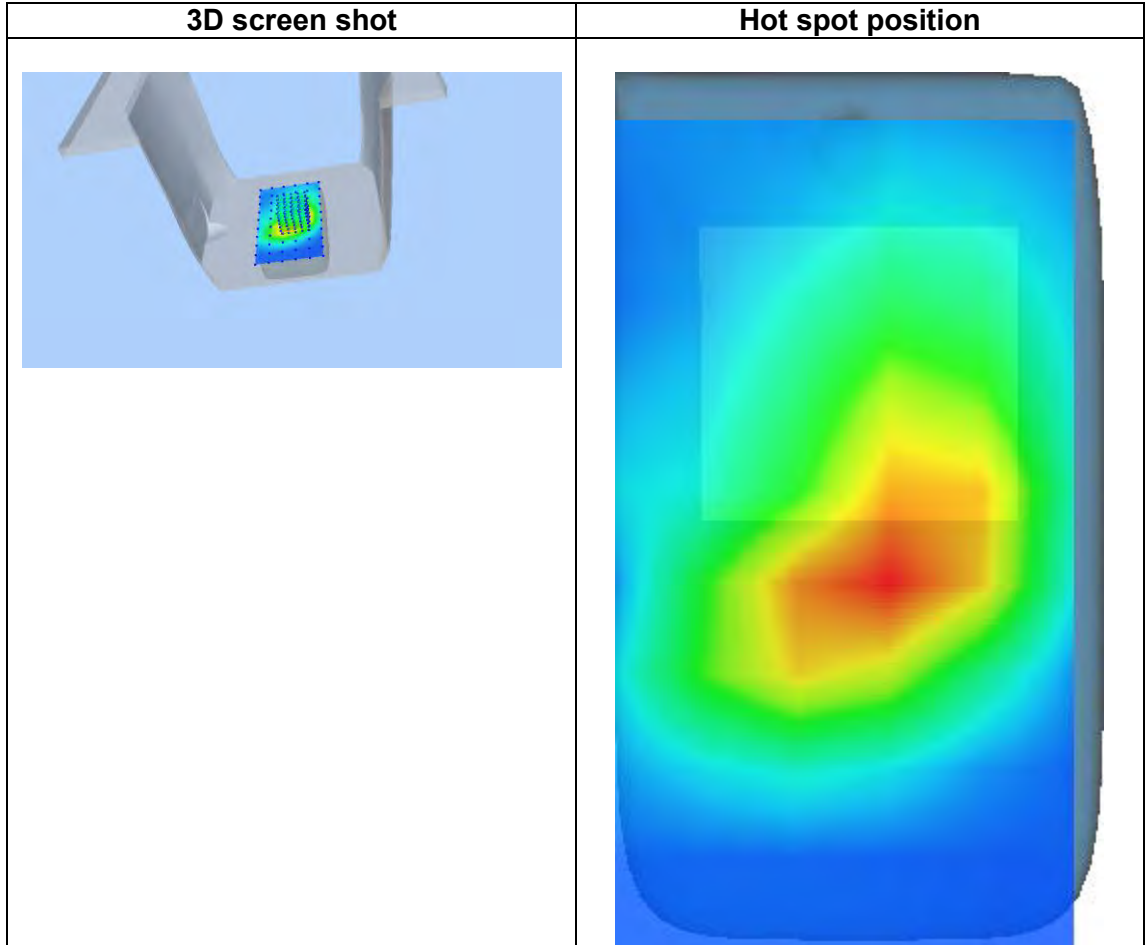
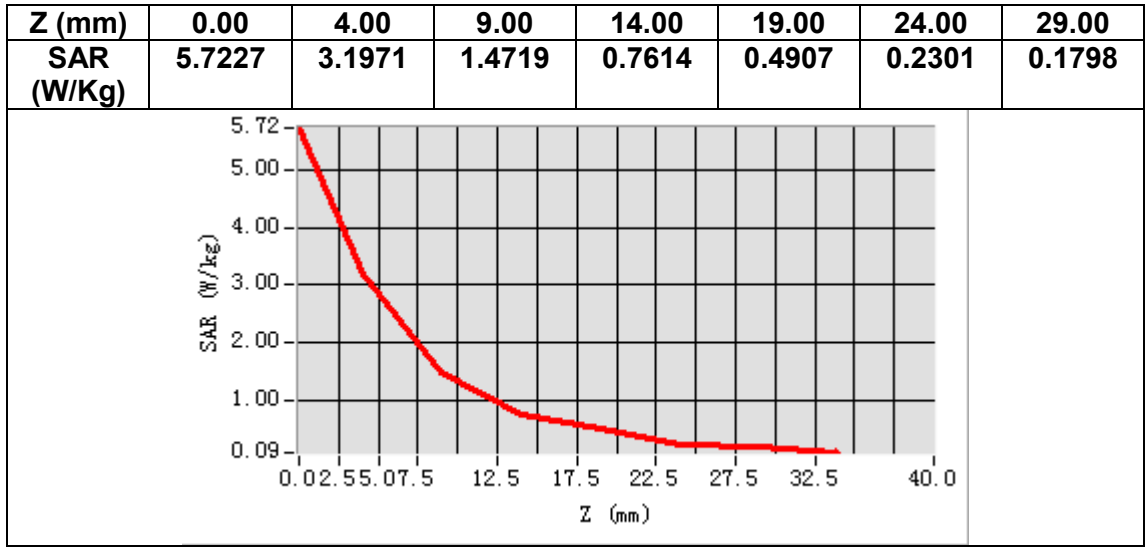

MEASUREMENT 15

Date of measurement: 6/12/2021

A. Experimental conditions.

Area Scan	<u>dx=12mm dy=12mm, h= 5.00 mm</u>
ZoomScan	<u>7x7x7, dx=5mm dy=5mm dz=5mm</u>
Phantom	<u>Left head</u>
Device Position	<u>Cheek</u>
Band	<u>LTE band 7</u>
Channels	<u>Middle</u>
Signal	<u>LTE (Crest factor: 1.0)</u>

B. SAR Measurement Results

Frequency (MHz)	2535.000000
Relative permittivity (real part)	39.701214
Relative permittivity (imaginary part)	13.515011
Conductivity (S/m)	1.903364
Variation (%)	-3.040000

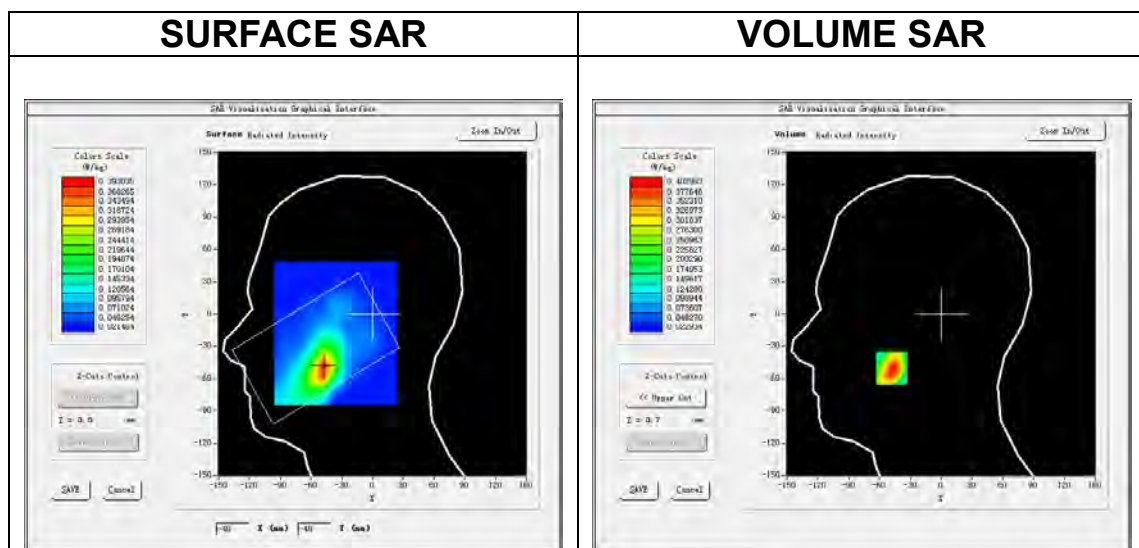

Maximum location: X=-48.00, Y=-50.00
SAR Peak: 0.60 W/kg

SAR 10g (W/Kg)	0.206436
SAR 1g (W/Kg)	0.371826

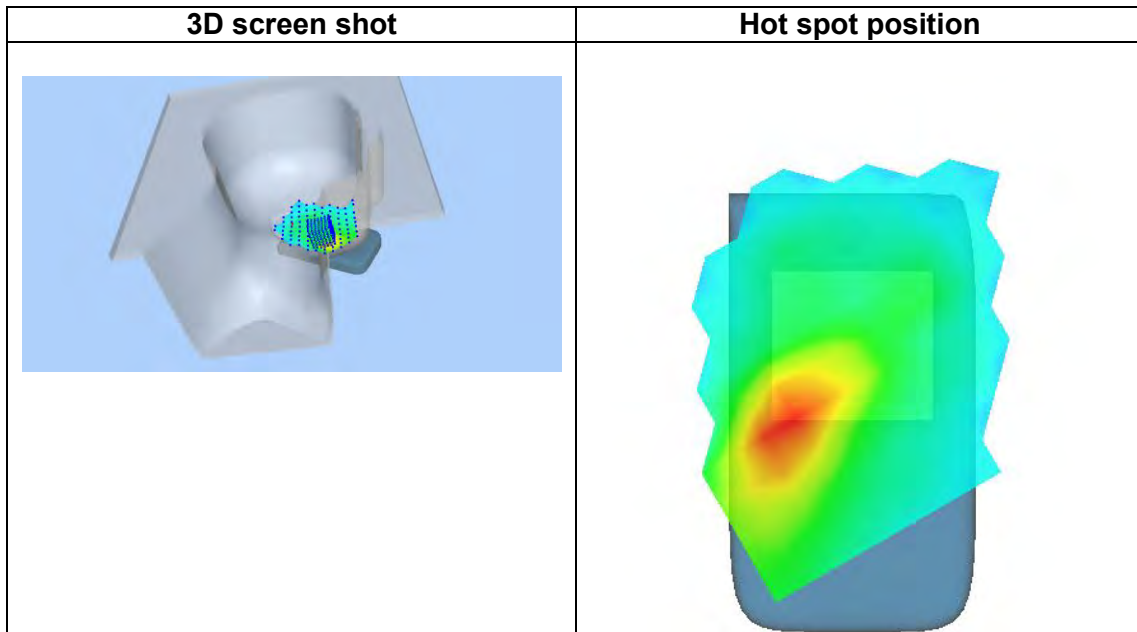
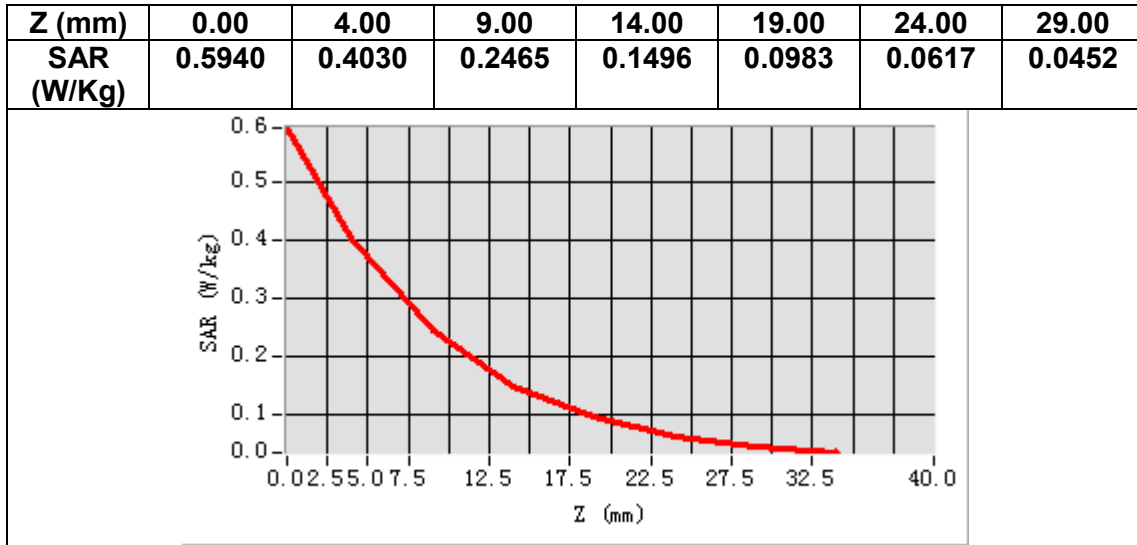

MEASUREMENT 16

Date of measurement: 6/12/2021

A. Experimental conditions.

Area Scan	<u>dx=12mm dy=12mm, h= 5.00 mm</u>
ZoomScan	<u>7x7x7, dx=5mm dy=5mm dz=5mm</u>
Phantom	<u>Validation plane</u>
Device Position	<u>Body</u>
Band	<u>LTE band 7</u>
Channels	<u>Middle</u>
Signal	<u>LTE (Crest factor: 1.0)</u>

B. SAR Measurement Results

Frequency (MHz)	2535.000000
Relative permittivity (real part)	39.701214
Relative permittivity (imaginary part)	13.515011
Conductivity (S/m)	1.903364
Variation (%)	0.810000

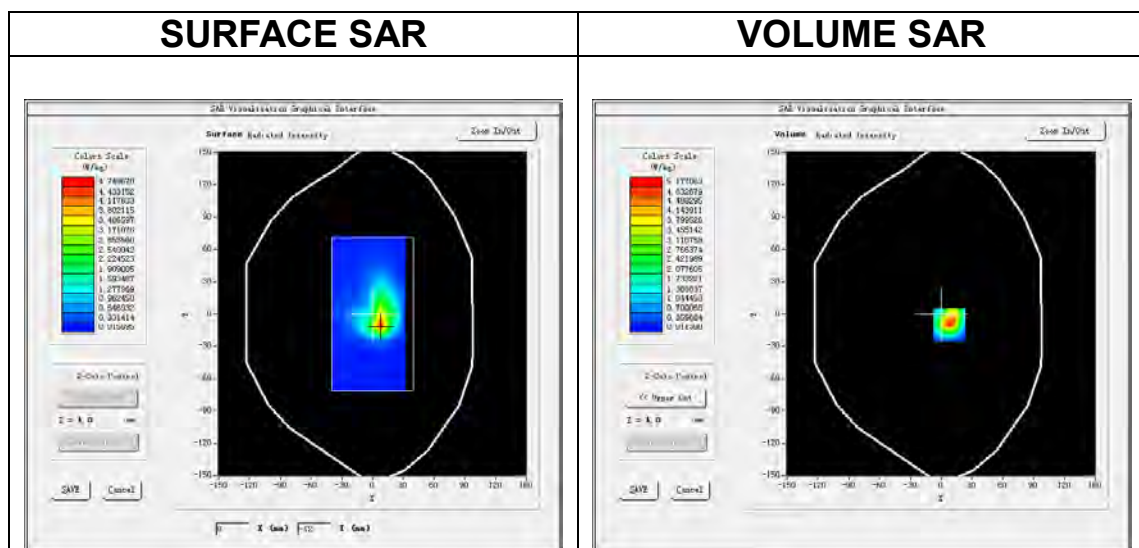

Maximum location: X=8.00, Y=-10.00

SAR Peak: 9.97 W/kg

SAR 10g (W/Kg)	1.758071
SAR 1g (W/Kg)	4.616912

Z (mm)	0.00	4.00	9.00	14.00	19.00	24.00	29.00
SAR (W/Kg)	10.1008	5.1771	1.9255	0.7664	0.3277	0.1461	0.0771

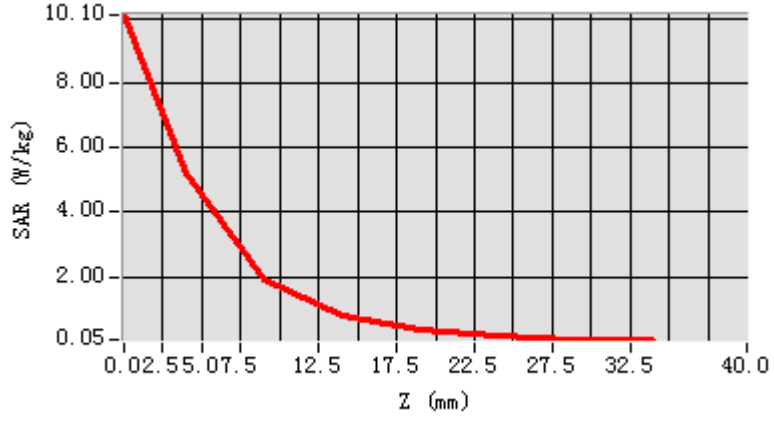

3D screen shot

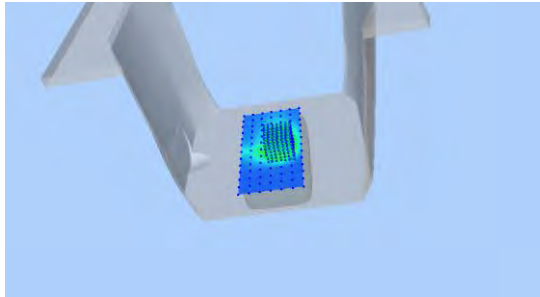

Hot spot position

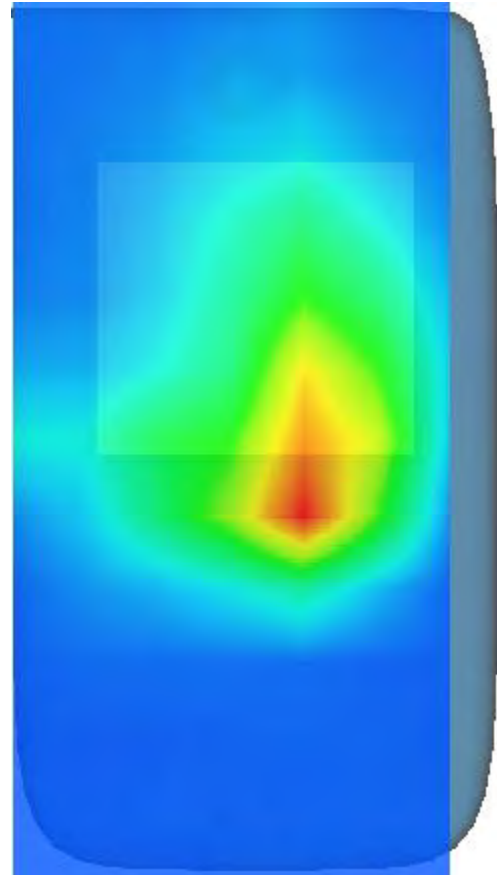

MEASUREMENT 17

Date of measurement: 29/11/2021

A. Experimental conditions.

Area Scan	<u>dx=15mm dy=15mm, h= 5.00 mm</u>
ZoomScan	<u>5x5x7, dx=8mm dy=8mm dz=5mm</u>
Phantom	<u>Left head</u>
Device Position	<u>Cheek</u>
Band	<u>LTE band 8</u>
Channels	<u>Middle</u>
Signal	<u>LTE (Crest factor: 1.0)</u>

B. SAR Measurement Results

Frequency (MHz)	897.500000
Relative permittivity (real part)	42.201771
Relative permittivity (imaginary part)	20.060587
Conductivity (S/m)	0.999686
Variation (%)	1.190000

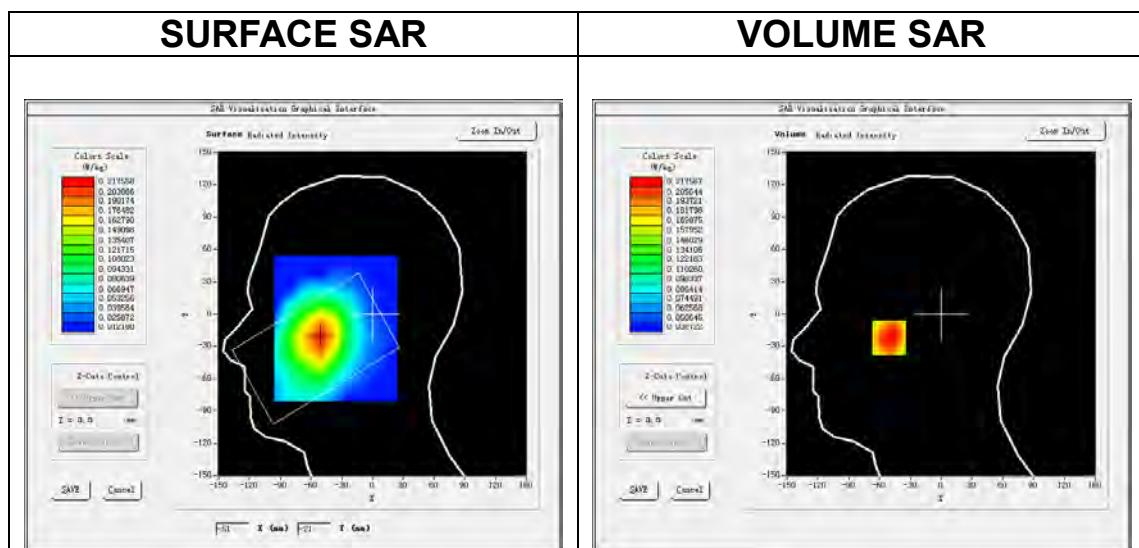

Maximum location: X=-51.00, Y=-22.00

SAR Peak: 0.27 W/kg

SAR 10g (W/Kg)	0.160780
SAR 1g (W/Kg)	0.216190

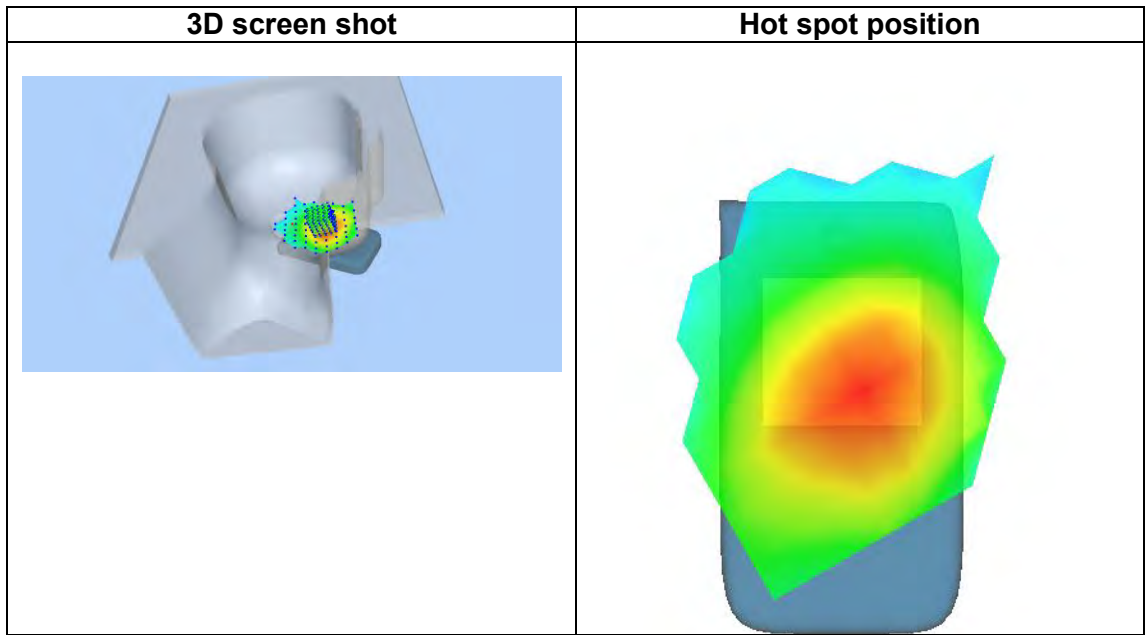
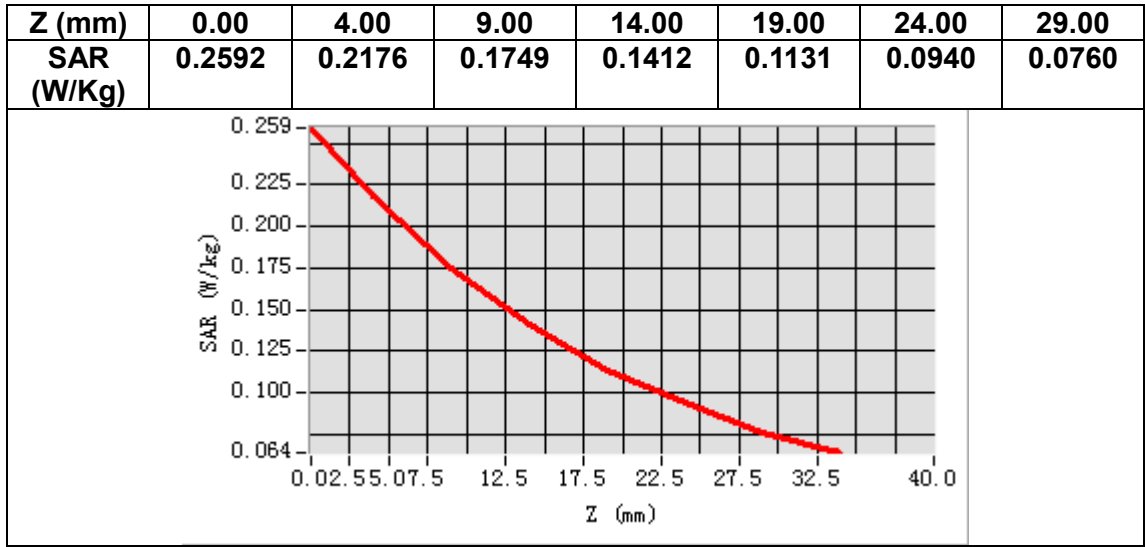

MEASUREMENT 18

Date of measurement: 29/11/2021

A. Experimental conditions.

Area Scan	<u>dx=15mm dy=15mm, h= 5.00 mm</u>
ZoomScan	<u>5x5x7, dx=8mm dy=8mm dz=5mm</u>
Phantom	<u>Validation plane</u>
Device Position	<u>Body</u>
Band	<u>LTE band 8</u>
Channels	<u>Middle</u>
Signal	<u>LTE (Crest factor: 1.0)</u>

B. SAR Measurement Results

Frequency (MHz)	897.500000
Relative permittivity (real part)	42.201771
Relative permittivity (imaginary part)	20.060587
Conductivity (S/m)	0.999686
Variation (%)	0.510000

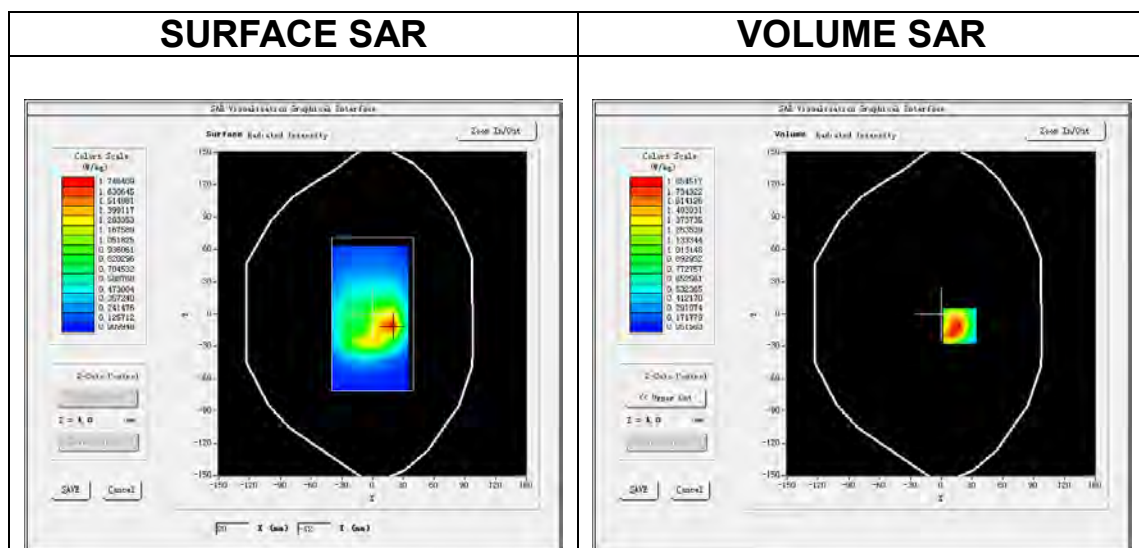

Maximum location: X=18.00, Y=-11.00
SAR Peak: 3.23 W/kg

SAR 10g (W/Kg)	0.973546
SAR 1g (W/Kg)	1.882968

Z (mm)	0.00	4.00	9.00	14.00	19.00	24.00	29.00
SAR (W/Kg)	2.9344	1.8545	1.0317	0.5972	0.3627	0.2303	0.1438

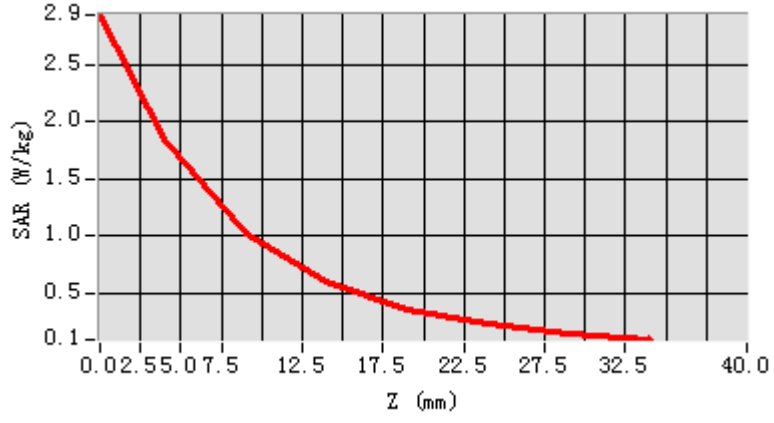

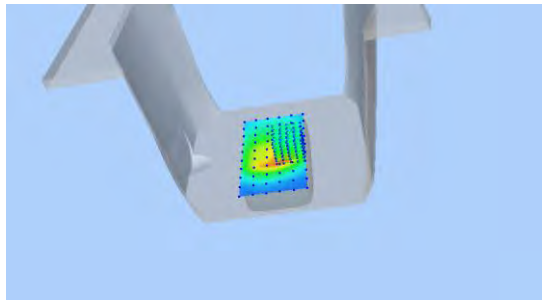
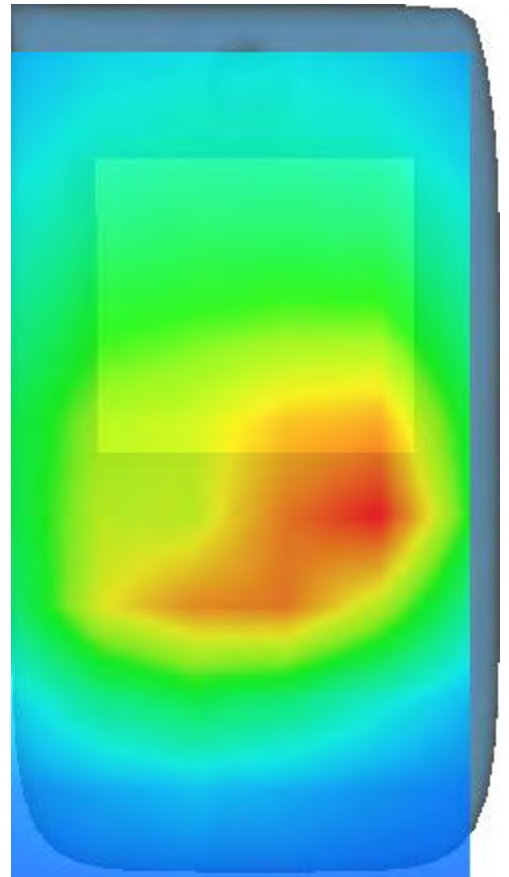
3D screen shot	Hot spot position
	

MEASUREMENT 19

Date of measurement: 29/11/2021

A. Experimental conditions.

Area Scan	<u>dx=15mm dy=15mm, h= 5.00 mm</u>
ZoomScan	<u>5x5x7, dx=8mm dy=8mm dz=5mm</u>
Phantom	<u>Left head</u>
Device Position	<u>Cheek</u>
Band	<u>LTE band 20</u>
Channels	<u>Middle</u>
Signal	<u>LTE (Crest factor: 1.0)</u>

B. SAR Measurement Results

Frequency (MHz)	847.000000
Relative permittivity (real part)	42.820572
Relative permittivity (imaginary part)	19.845688
Conductivity (S/m)	0.933850
Variation (%)	0.620000

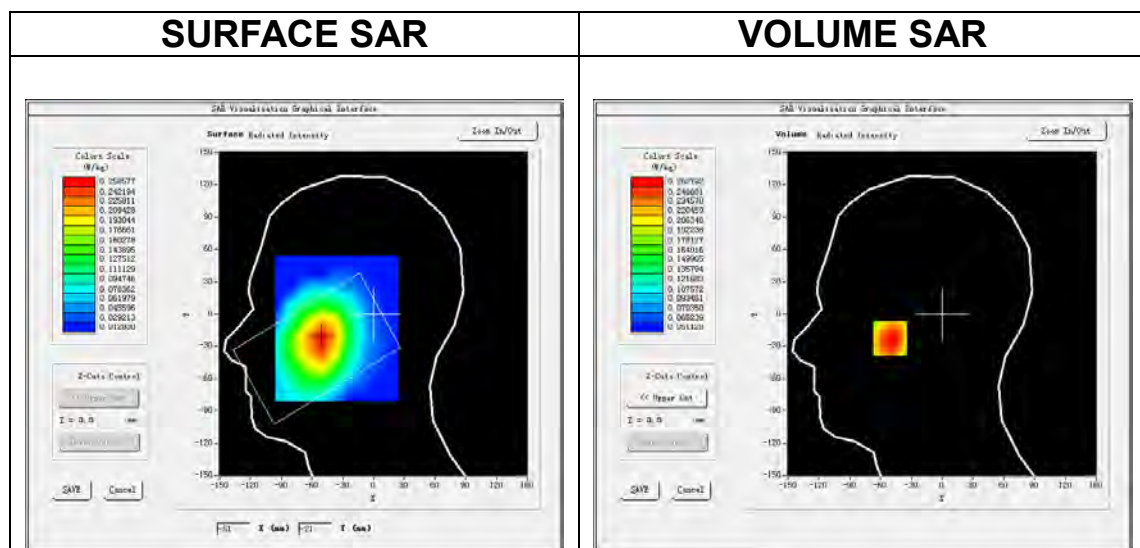

Maximum location: X=-51.00, Y=-23.00

SAR Peak: 0.32 W/kg

SAR 10g (W/Kg)	0.198062
SAR 1g (W/Kg)	0.258142

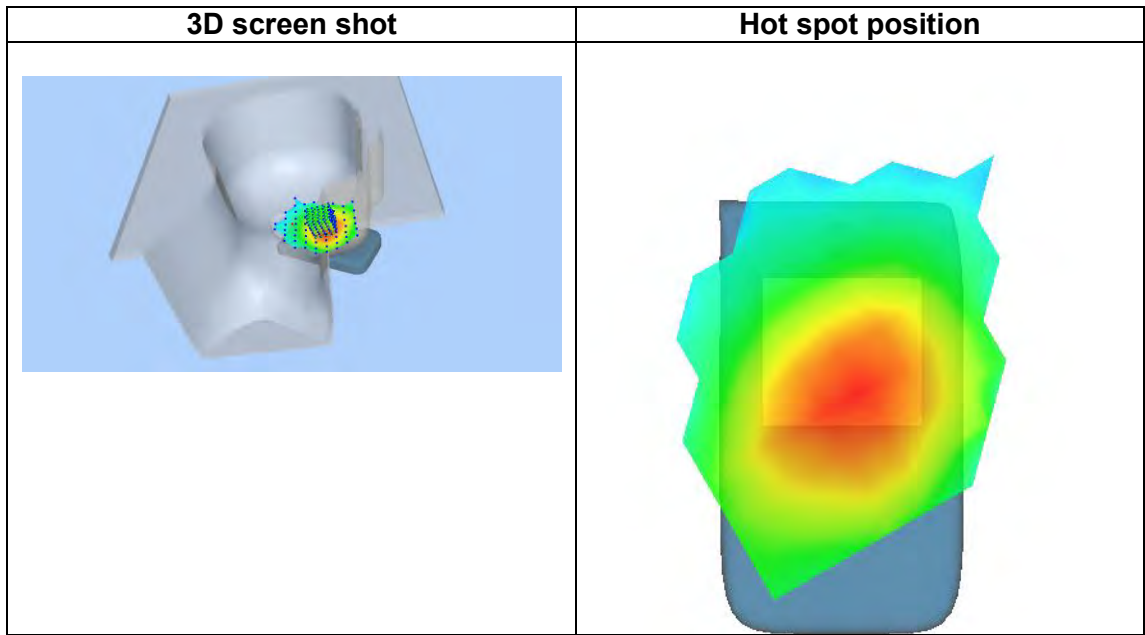
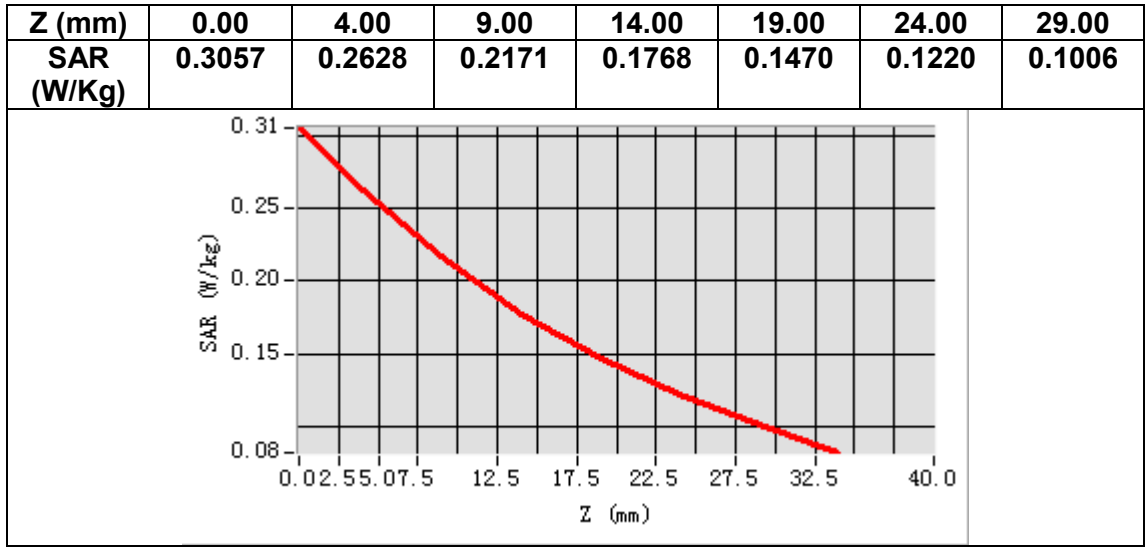

MEASUREMENT 20

Date of measurement: 29/11/2021

A. Experimental conditions.

Area Scan	<u>dx=15mm dy=15mm, h= 5.00 mm</u>
ZoomScan	<u>5x5x7, dx=8mm dy=8mm dz=5mm</u>
Phantom	<u>Validation plane</u>
Device Position	<u>Body</u>
Band	<u>LTE band 20</u>
Channels	<u>Middle</u>
Signal	<u>LTE (Crest factor: 1.0)</u>

B. SAR Measurement Results

Frequency (MHz)	847.000000
Relative permittivity (real part)	42.820572
Relative permittivity (imaginary part)	19.845688
Conductivity (S/m)	0.933850
Variation (%)	-0.700000

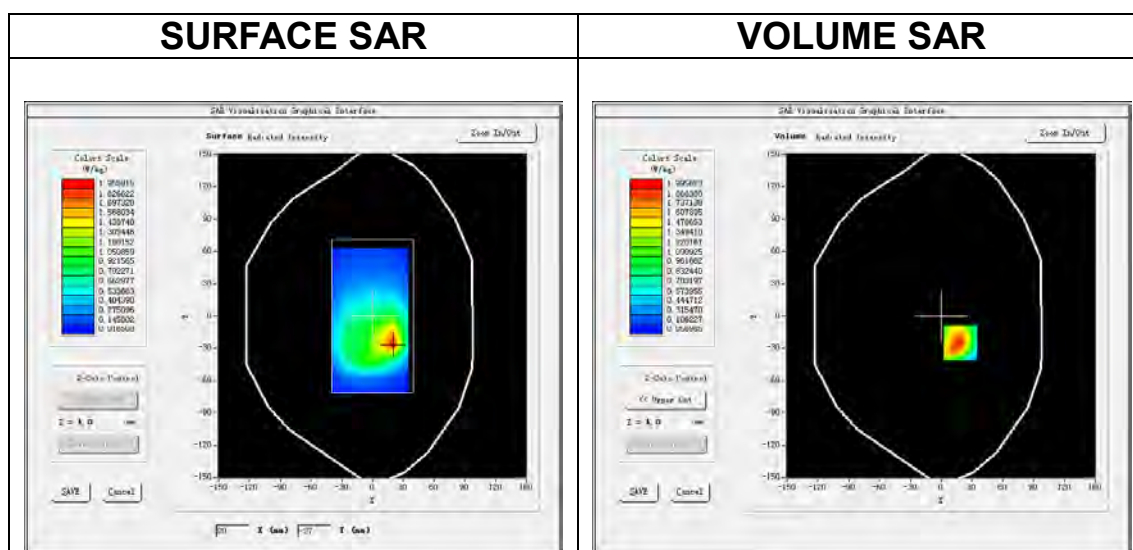

Maximum location: X=19.00, Y=-25.00

SAR Peak: 3.29 W/kg

SAR 10g (W/Kg)	1.021891
SAR 1g (W/Kg)	1.932329

Z (mm)	0.00	4.00	9.00	14.00	19.00	24.00	29.00
SAR (W/Kg)	3.1550	1.9956	1.1075	0.6409	0.3899	0.2499	0.1632

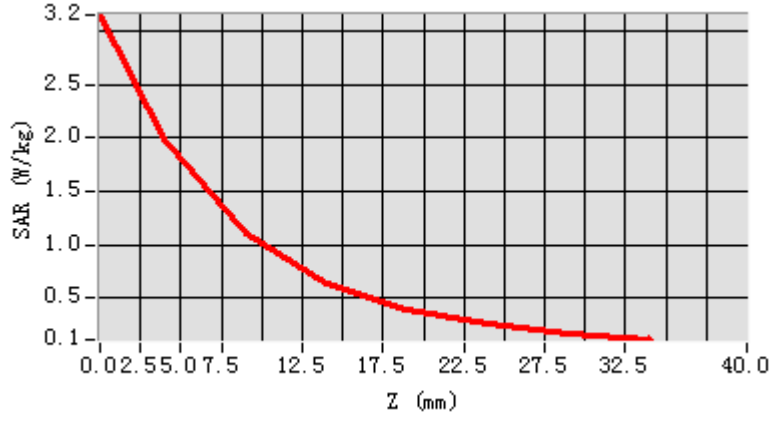

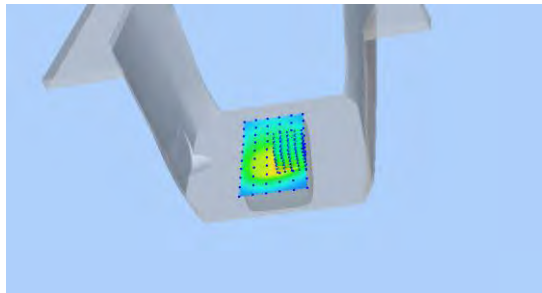
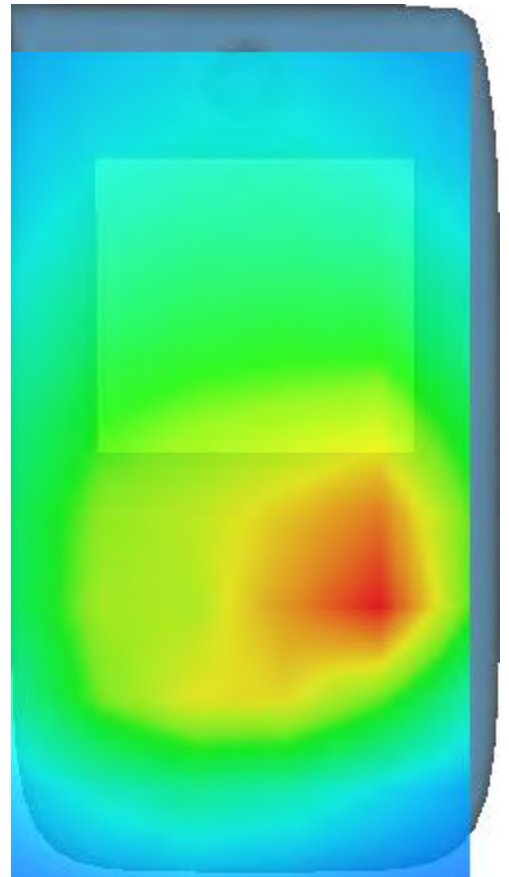
3D screen shot	Hot spot position
	

MEASUREMENT 21

Date of measurement: 3/12/2021

A. Experimental conditions.

Area Scan	<u>dx=12mm dy=12mm, h= 5.00 mm</u>
ZoomScan	<u>7x7x7,dx=5mm dy=5mm dz=5mm</u>
Phantom	<u>Left head</u>
Device Position	<u>Cheek</u>
Band	<u>LTE band 40</u>
Channels	<u>Middle</u>
Signal	<u>LTE (Crest factor: 1.6)</u>

B. SAR Measurement Results

Frequency (MHz)	2350.000000
Relative permittivity (real part)	39.889427
Relative permittivity (imaginary part)	13.075978
Conductivity (S/m)	1.707142
Variation (%)	-4.060000

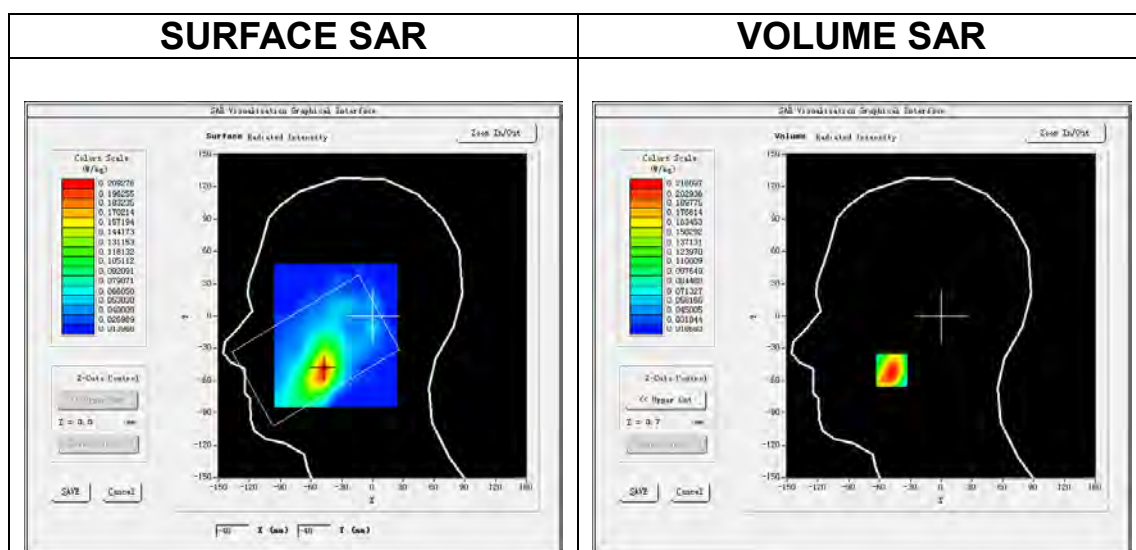

Maximum location: X=-48.00, Y=-50.00

SAR Peak: 0.34 W/kg

SAR 10g (W/Kg)	0.117717
SAR 1g (W/Kg)	0.190434

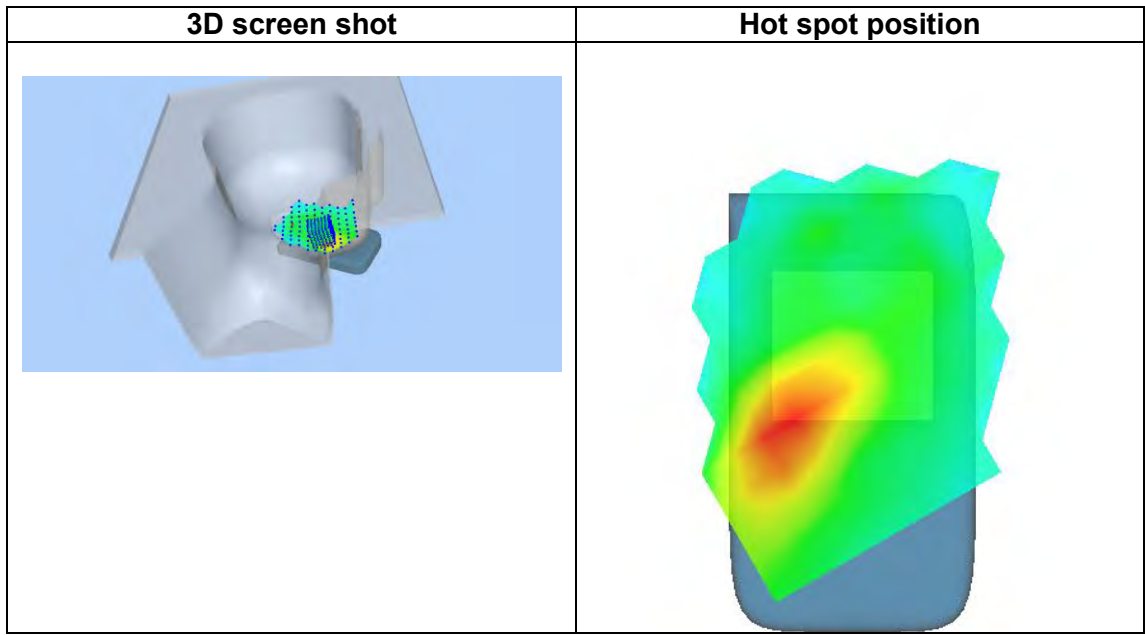
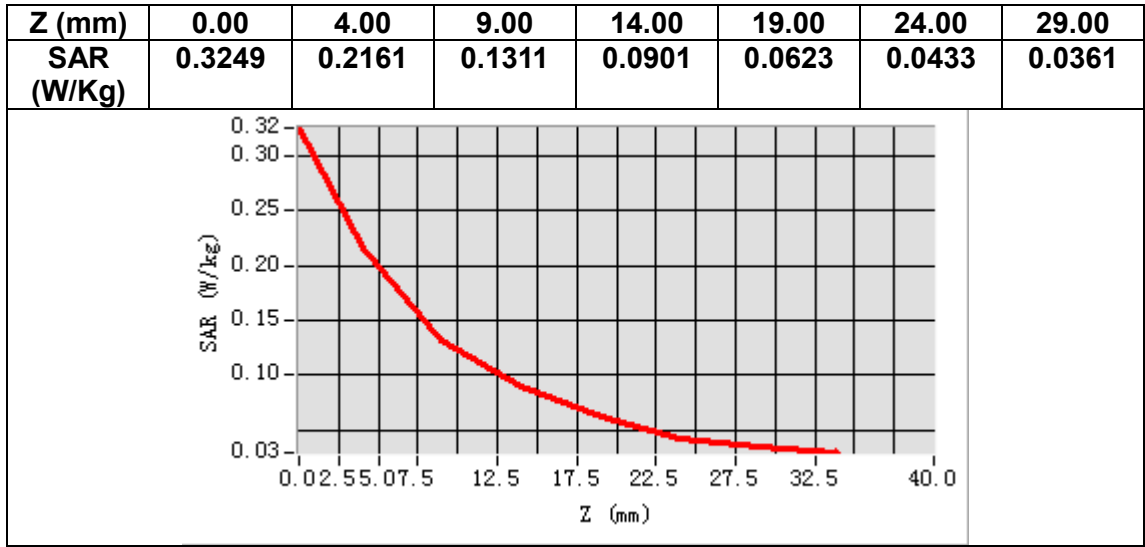

MEASUREMENT 22

Date of measurement: 3/12/2021

A. Experimental conditions.

Area Scan	<u>dx=12mm dy=12mm, h= 5.00 mm</u>
ZoomScan	<u>7x7x7, dx=5mm dy=5mm dz=5mm</u>
Phantom	<u>Validation plane</u>
Device Position	<u>Body</u>
Band	<u>LTE band 40</u>
Channels	<u>Middle</u>
Signal	<u>LTE (Crest factor: 1.6)</u>

B. SAR Measurement Results

Frequency (MHz)	2350.000000
Relative permittivity (real part)	39.889427
Relative permittivity (imaginary part)	13.075978
Conductivity (S/m)	1.707142
Variation (%)	-3.230000

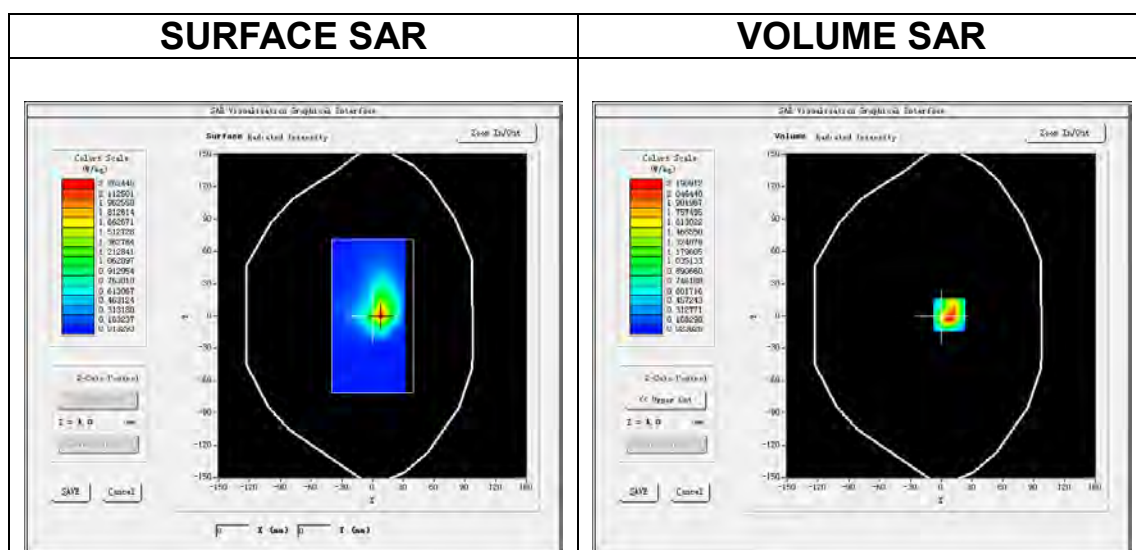

Maximum location: X=8.00, Y=1.00

SAR Peak: 4.20 W/kg

SAR 10g (W/Kg)	0.845294
SAR 1g (W/Kg)	2.056552

Z (mm)	0.00	4.00	9.00	14.00	19.00	24.00	29.00
SAR (W/Kg)	4.3518	2.1909	0.7955	0.4090	0.1935	0.0935	0.0547

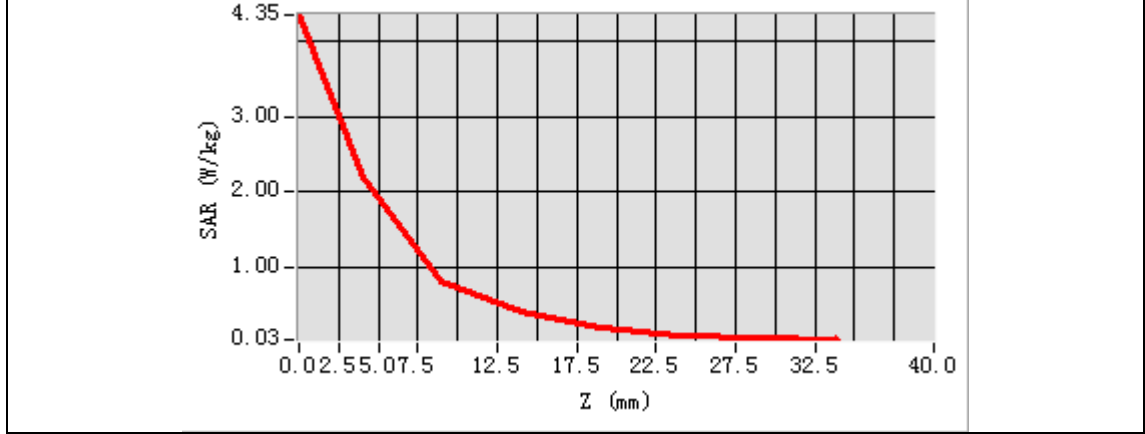

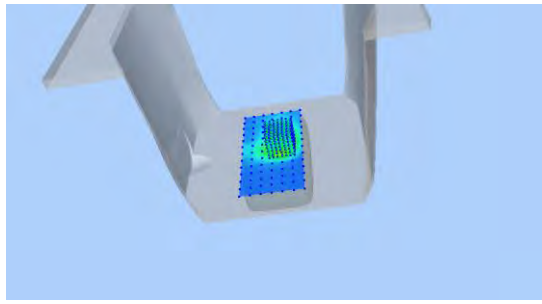
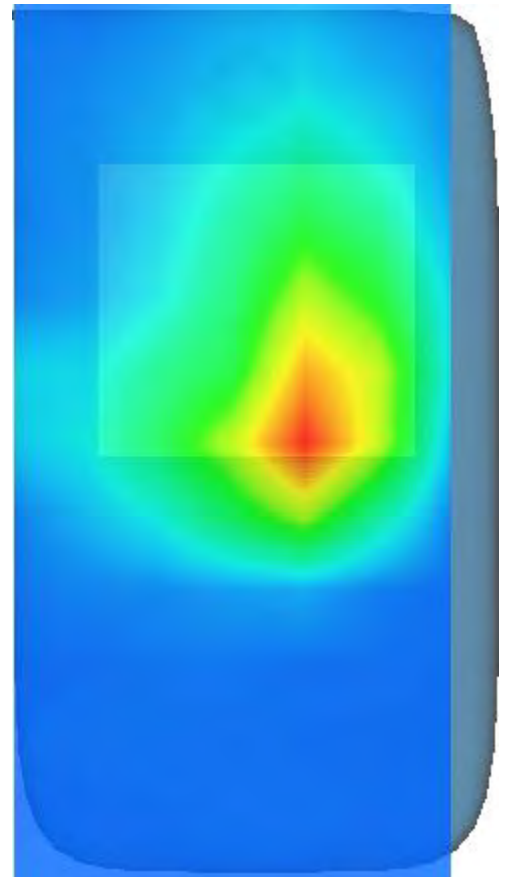
3D screen shot	Hot spot position
	

13. Appendix D. Calibration Certificate

Table of contents
E Field Probe - SN 08/16 EPGO287
900 MHz Dipole - SN 03/15 DIP 0G900-348
1800 MHz Dipole - SN 03/15 DIP 1G800-349
2000 MHz Dipole - SN 03/15 DIP 2G000-351
2300 MHz Dipole - SN 03/16 DIP 2G300-358
2450 MHz Dipole - SN 03/15 DIP 2G450-352
2600 MHz Dipole - SN 03/15 DIP 2G600-356



COMOSAR E-Field Probe Calibration Report

Ref : ACR.60.1.21.MVGB.A

SHENZHEN NTEK TESTING TECHNOLOGY CO., LTD.

BUILDING E, FENDA SCIENCE PARK, SANWEI
COMMUNITY, XIXIANG STREET,
BAO'AN DISTRICT, SHENZHEN GUANGDONG, CHINA
MVG COMOSAR DOSIMETRIC E-FIELD PROBE
SERIAL NO.: SN 08/16 EPGO287

Calibrated at MVG

Z.I. de la pointe du diable

Technopôle Brest Iroise – 295 avenue Alexis de Rochon
29280 PLOUZANE - FRANCE

Calibration date: 03/01/2021



Accreditations #2-6789 and #2-6814
Scope available on www.cofrac.fr

Summary:

This document presents the method and results from an accredited COMOSAR E-Field Probe calibration performed at MVG, using the CALIPROBE test bench, for use with a MVG COMOSAR system only. The test results covered by accreditation are traceable to the International System of Units (SI).



COMOSAR E-FIELD PROBE CALIBRATION REPORT

Ref: ACR.60.1.21.MVGB.A

	Name	Function	Date	Signature
Prepared by :	Jérôme Luc	Technical Manager	3/1/2021	<i>JLS</i>
Checked by :	Jérôme Luc	Technical Manager	3/1/2021	<i>JLS</i>
Approved by :	Yann Toutain	Laboratory Director	3/1/2021	<i>Yann Toutain</i>

Made d'emploi
2021.03.0
1 13:07:12
+01'00'

PHILIPS

	Customer Name
Distribution :	SHENZHEN NTEK TESTING TECHNOLOGY CO., LTD.

Issue	Name	Date	Modifications
A	Jérôme Luc	3/1/2021	Initial release



COMOSAR E-FIELD PROBE CALIBRATION REPORT

Ref: ACR.60.1.21.MVGB.A

TABLE OF CONTENTS

1	Device Under Test	4
2	Product Description	4
2.1	General Information	4
3	Measurement Method	4
3.1	Linearity	4
3.2	Sensitivity	5
3.3	Lower Detection Limit	5
3.4	Isotropy	5
3.1	Boundary Effect	5
4	Measurement Uncertainty	6
5	Calibration Measurement Results	6
5.1	Sensitivity in air	6
5.2	Linearity	7
5.3	Sensitivity in liquid	8
5.4	Isotropy	9
6	List of Equipment	10



COMOSAR E-FIELD PROBE CALIBRATION REPORT

Ref: ACR.60.1.21.MVGB.A

1 DEVICE UNDER TEST

Device Under Test	
Device Type	COMOSAR DOSIMETRIC E FIELD PROBE
Manufacturer	MVG
Model	SSE2
Serial Number	SN 08/16 EPGO287
Product Condition (new / used)	Used
Frequency Range of Probe	0.15 GHz-6GHz
Resistance of Three Dipoles at Connector	Dipole 1: R1=0.211 MΩ Dipole 2: R2=0.199 MΩ Dipole 3: R3=0.199 MΩ

2 PRODUCT DESCRIPTION

2.1 GENERAL INFORMATION

MVG’s COMOSAR E field Probes are built in accordance to the IEEE 1528, FCC KDB865664 D01, CENELEC EN62209 and CEI/IEC 62209 standards.



Figure 1 – MVG COMOSAR Dosimetric E field Dipole

Probe Length	330 mm
Length of Individual Dipoles	2 mm
Maximum external diameter	8 mm
Probe Tip External Diameter	2.5 mm
Distance between dipoles / probe extremity	1 mm

3 MEASUREMENT METHOD

The IEEE 1528, FCC KDB865664 D01, CENELEC EN62209 and CEI/IEC 62209 standards provide recommended practices for the probe calibrations, including the performance characteristics of interest and methods by which to assess their affect. All calibrations / measurements performed meet the fore mentioned standards.

3.1 LINEARITY

The evaluation of the linearity was done in free space using the waveguide, performing a power sweep to cover the SAR range 0.01W/kg to 100W/kg.



COMOSAR E-FIELD PROBE CALIBRATION REPORT

Ref: ACR.60.1.21.MVGB.A

3.2 SENSITIVITY

The sensitivity factors of the three dipoles were determined using a two step calibration method (air and tissue simulating liquid) using waveguides as outlined in the standards.

3.3 LOWER DETECTION LIMIT

The lower detection limit was assessed using the same measurement set up as used for the linearity measurement. The required lower detection limit is 10 mW/kg.

3.4 ISOTROPY

The axial isotropy was evaluated by exposing the probe to a reference wave from a standard dipole with the dipole mounted under the flat phantom in the test configuration suggested for system validations and checks. The probe was rotated along its main axis from 0 to 360 degrees in 15-degree steps. The hemispherical isotropy is determined by inserting the probe in a thin plastic box filled with tissue-equivalent liquid, with the plastic box illuminated with the fields from a half wave dipole. The dipole is rotated about its axis (0°–180°) in 15° increments. At each step the probe is rotated about its axis (0°–360°).

3.1 BOUNDARY EFFECT

The boundary effect is defined as the deviation between the SAR measured data and the expected exponential decay in the liquid when the probe is oriented normal to the interface. To evaluate this effect, the liquid filled flat phantom is exposed to fields from either a reference dipole or waveguide. With the probe normal to the phantom surface, the peak spatial average SAR is measured and compared to the analytical value at the surface.

The boundary effect uncertainty can be estimated according to the following uncertainty approximation formula based on linear and exponential extrapolations between the surface and $d_{be} + d_{step}$ along lines that are approximately normal to the surface:

$$SAR_{uncertainty} [\%] = \delta SAR_{be} \frac{(d_{be} + d_{step})^2 (e^{-\alpha_{be}(\delta/\beta)})}{2d_{step} \delta/2} \text{ for } (d_{be} + d_{step}) < 10 \text{ mm}$$

where

- SAR_{uncertainty} is the uncertainty in percent of the probe boundary effect
- d_{be} is the distance between the surface and the closest *zoom-scan* measurement point, in millimetre
- Δ_{step} is the separation distance between the first and second measurement points that are closest to the phantom surface, in millimetre, assuming the boundary effect at the second location is negligible
- δ is the minimum penetration depth in millimetres of the head tissue-equivalent liquids defined in this standard, i.e., $\delta \approx 14$ mm at 3 GHz;
- ΔSAR_{be} in percent of SAR is the deviation between the measured SAR value, at the distance d_{be} from the boundary, and the analytical SAR value.



COMOSAR E-FIELD PROBE CALIBRATION REPORT

Ref: ACR.60.1.21.MVGB.A

The measured worst case boundary effect SAR uncertainty [%] for scanning distances larger than 4mm is 1.0% Limit ,2%).

4 MEASUREMENT UNCERTAINTY

The guidelines outlined in the IEEE 1528, OET 65 Bulletin C, CENELEC EN50361 and CEI/IEC 62209 standards were followed to generate the measurement uncertainty associated with an E-field probe calibration using the waveguide technique. All uncertainties listed below represent an expanded uncertainty expressed at approximately the 95% confidence level using a coverage factor of k=2, traceable to the Internationally Accepted Guides to Measurement Uncertainty.

Uncertainty analysis of the probe calibration in waveguide					
ERROR SOURCES	Uncertainty value (%)	Probability Distribution	Divisor	ci	Standard Uncertainty (%)
Expanded uncertainty 95 % confidence level k = 2					14 %

5 CALIBRATION MEASUREMENT RESULTS

Calibration Parameters	
Liquid Temperature	20 +/- 1 °C
Lab Temperature	20 +/- 1 °C
Lab Humidity	30-70 %

5.1 SENSITIVITY IN AIR

Normx dipole 1 (µV/(V/m) ²)	Normy dipole 2 (µV/(V/m) ²)	Normz dipole 3 (µV/(V/m) ²)
0.72	0.66	0.77

DCP dipole 1 (mV)	DCP dipole 2 (mV)	DCP dipole 3 (mV)
107	110	110

Calibration curves $e_i=f(V)$ (i=1,2,3) allow to obtain E-field value using the formula:

$$E = \sqrt{E_1^2 + E_2^2 + E_3^2}$$



COMOSAR E-FIELD PROBE CALIBRATION REPORT

Ref: ACR.60.1.21.MVGB.A

Calibration curves

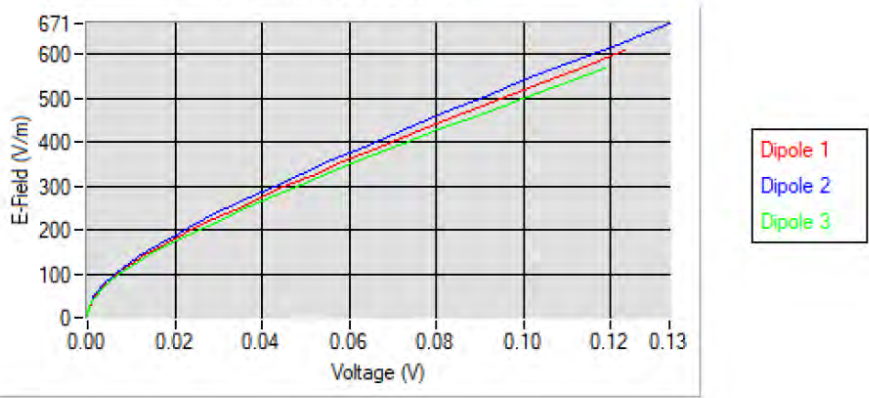

5.2 LINEARITY

Linearity

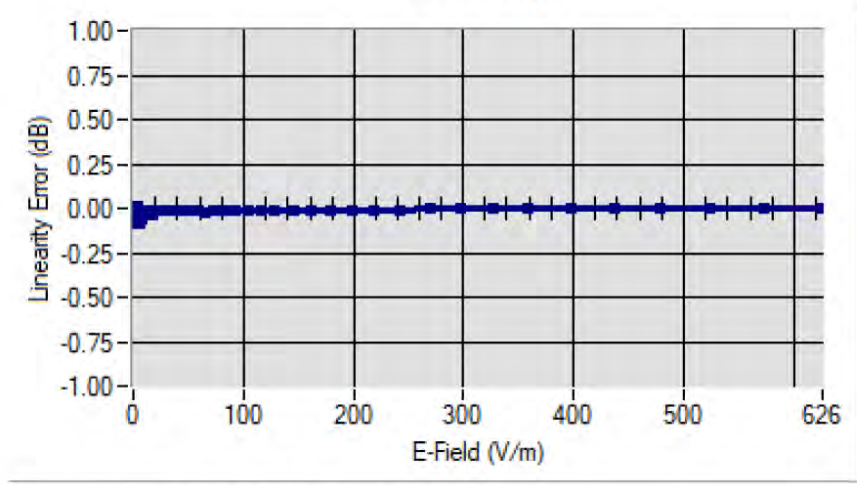

Linearity: +/- 1.90% (+/- 0.08dB)



COMOSAR E-FIELD PROBE CALIBRATION REPORT

Ref: ACR.60.1.21.MVGB.A

5.3 SENSITIVITY IN LIQUID

Liquid	Frequency (MHz +/- 100MHz)	ConvF
HL750	750	1.49
HL850	835	1.50
HL900	900	1.61
HL1800	1800	1.73
HL1900	1900	1.91
HL2000	2000	1.97
HL2300	2300	1.92
HL2450	2450	1.98
HL2600	2600	1.87
HL3300	3300	1.79
HL3500	3500	1.85
HL3700	3700	1.79
HL3900	3900	2.07
HL4200	4200	2.21
HL4600	4600	2.25
HL4900	4900	2.05
HL5200	5200	1.80
HL5400	5400	2.05
HL5600	5600	2.16
HL5800	5800	2.07

LOWER DETECTION LIMIT: 8mW/kg



COMOSAR E-FIELD PROBE CALIBRATION REPORT

Ref: ACR.60.1.21.MVGB.A

5.4 ISOTROPY

HL1800 MHz

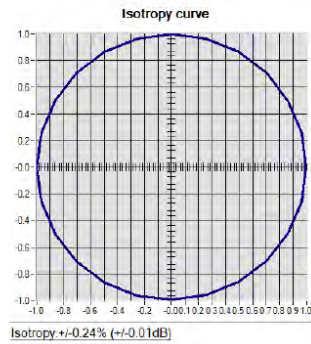



COMOSAR E-FIELD PROBE CALIBRATION REPORT

Ref: ACR.60.1.21.MVGB.A

6 LIST OF EQUIPMENT

Equipment Summary Sheet				
Equipment Description	Manufacturer / Model	Identification No.	Current Calibration Date	Next Calibration Date
Flat Phantom	MVG	SN-20/09-SAM71	Validated. No cal required.	Validated. No cal required.
COMOSAR Test Bench	Version 3	NA	Validated. No cal required.	Validated. No cal required.
Network Analyzer	Rohde & Schwarz ZVM	100203	05/2019	05/2022
Network Analyzer – Calibration kit	Rohde & Schwarz ZV-Z235	101223	05/2019	05/2022
Multimeter	Keithley 2000	1160271	02/2020	02/2023
Signal Generator	Rohde & Schwarz SMB	106589	04/2019	04/2022
Amplifier	Aethercomm	SN 046	Characterized prior to test. No cal required.	Characterized prior to test. No cal required.
Power Meter	NI-USB 5680	170100013	05/2019	05/2022
Directional Coupler	Narda 4216-20	01386	Characterized prior to test. No cal required.	Characterized prior to test. No cal required.
Waveguide	Mega Industries	069Y7-158-13-712	Validated. No cal required.	Validated. No cal required.
Waveguide Transition	Mega Industries	069Y7-158-13-701	Validated. No cal required.	Validated. No cal required.
Waveguide Termination	Mega Industries	069Y7-158-13-701	Validated. No cal required.	Validated. No cal required.
Temperature / Humidity Sensor	Testo 184 H1	44220687	05/2020	05/2023



SAR Reference Dipole Calibration Report

Ref : ACR.60.4.21.MVGB.A

SHENZHEN NTEK TESTING TECHNOLOGY CO., LTD.

BUILDING E, FENDA SCIENCE PARK, SANWEI
COMMUNITY, XIXIANG STREET,
BAO'AN DISTRICT, SHENZHEN GUANGDONG, CHINA

MVG COMOSAR REFERENCE DIPOLE

FREQUENCY: 900 MHZ

SERIAL NO.: SN 03/15 DIP0G900-348

Calibrated at MVG

Z.I. de la pointe du diable

Technopôle Brest Iroise – 295 avenue Alexis de Rochon
29280 PLOUZANE - FRANCE

Calibration date: 03/01/2021



Accreditations #2-6789 and #2-6814
Scope available on www.cofrac.fr

Summary:

This document presents the method and results from an accredited SAR reference dipole calibration performed at MVG, using the COMOSAR test bench. The test results covered by accreditation are traceable to the International System of Units (SI).



SAR REFERENCE DIPOLE CALIBRATION REPORT

Ref: ACR.60.4.21.MVGB.A

	Name	Function	Date	Signature
Prepared by :	Jérôme Luc	Technical Manager	3/1/2021	<i>JLS</i>
Checked by :	Jérôme Luc	Technical Manager	3/1/2021	<i>JLS</i>
Approved by :	Yann Toutain	Laboratory Director	3/1/2021	<i>Yann Toutain</i>

Made at: 2021.03.01
 13:09:56
 +01'00'

	Customer Name
Distribution :	SHENZHEN NTEK TESTING TECHNOLOGY CO., LTD.

Issue	Name	Date	Modifications
A	Jérôme Luc	3/1/2021	Initial release



SAR REFERENCE DIPOLE CALIBRATION REPORT

Ref: ACR.60.4.21.MVGB.A

TABLE OF CONTENTS

1	Introduction.....	4
2	Device Under Test	4
3	Product Description	4
3.1	General Information	4
4	Measurement Method	5
4.1	Return Loss Requirements	5
4.2	Mechanical Requirements	5
5	Measurement Uncertainty	5
5.1	Return Loss	5
5.2	Dimension Measurement	5
5.3	Validation Measurement	5
6	Calibration Measurement Results	6
6.1	Return Loss and Impedance	6
6.2	Mechanical Dimensions	6
7	Validation measurement	7
7.1	Measurement Condition	7
7.2	Head Liquid Measurement	7
7.3	Measurement Result	8
8	List of Equipment	10



SAR REFERENCE DIPOLE CALIBRATION REPORT

Ref: ACR.60.4.21.MVGB.A

1 INTRODUCTION

This document contains a summary of the requirements set forth by the IEEE 1528, FCC KDBs and CEI/IEC 62209 standards for reference dipoles used for SAR measurement system validations and the measurements that were performed to verify that the product complies with the fore mentioned standards.

2 DEVICE UNDER TEST

Device Under Test	
Device Type	COMOSAR 900 MHz REFERENCE DIPOLE
Manufacturer	MVG
Model	SID900
Serial Number	SN 03/15 DIP0G900-348
Product Condition (new / used)	Used

3 PRODUCT DESCRIPTION

3.1 GENERAL INFORMATION

MVG’s COMOSAR Validation Dipoles are built in accordance to the IEEE 1528, FCC KDBs and CEI/IEC 62209 standards. The product is designed for use with the COMOSAR test bench only.



Figure 1 – MVG COMOSAR Validation Dipole



SAR REFERENCE DIPOLE CALIBRATION REPORT

Ref: ACR.60.4.21.MVGB.A

4 MEASUREMENT METHOD

The IEEE 1528, FCC KDBs and CEI/IEC 62209 standards provide requirements for reference dipoles used for system validation measurements. The following measurements were performed to verify that the product complies with the fore mentioned standards.

4.1 RETURN LOSS REQUIREMENTS

The dipole used for SAR system validation measurements and checks must have a return loss of -20 dB or better. The return loss measurement shall be performed against a liquid filled flat phantom, with the phantom constructed as outlined in the fore mentioned standards. A direct method is used with a network analyser and its calibration kit, both with a valid ISO17025 calibration.

4.2 MECHANICAL REQUIREMENTS

The IEEE Std. 1528 and CEI/IEC 62209 standards specify the mechanical components and dimensions of the validation dipoles, with the dimension's frequency and phantom shell thickness dependent. The COMOSAR test bench employs a 2 mm phantom shell thickness therefore the dipoles sold for use with the COMOSAR test bench comply with the requirements set forth for a 2 mm phantom shell thickness. A direct method is used with a ISO17025 calibrated caliper.

5 MEASUREMENT UNCERTAINTY

All uncertainties listed below represent an expanded uncertainty expressed at approximately the 95% confidence level using a coverage factor of k=2, traceable to the Internationally Accepted Guides to Measurement Uncertainty.

5.1 RETURN LOSS

The following uncertainties apply to the return loss measurement:

Frequency band	Expanded Uncertainty on Return Loss
400-6000MHz	0.08 LIN

5.2 DIMENSION MEASUREMENT

The following uncertainties apply to the dimension measurements:

Length (mm)	Expanded Uncertainty on Length
0 - 300	0.20 mm
300 - 450	0.44 mm

5.3 VALIDATION MEASUREMENT

The guidelines outlined in the IEEE 1528, FCC KDBs, CENELEC EN50361 and CEI/IEC 62209 standards were followed to generate the measurement uncertainty for validation measurements.

Scan Volume	Expanded Uncertainty



SAR REFERENCE DIPOLE CALIBRATION REPORT

Ref. ACR.60.4.21.MVGB.A

1 g	19 % (SAR)
10 g	19 % (SAR)

6 CALIBRATION MEASUREMENT RESULTS

6.1 RETURN LOSS AND IMPEDANCE

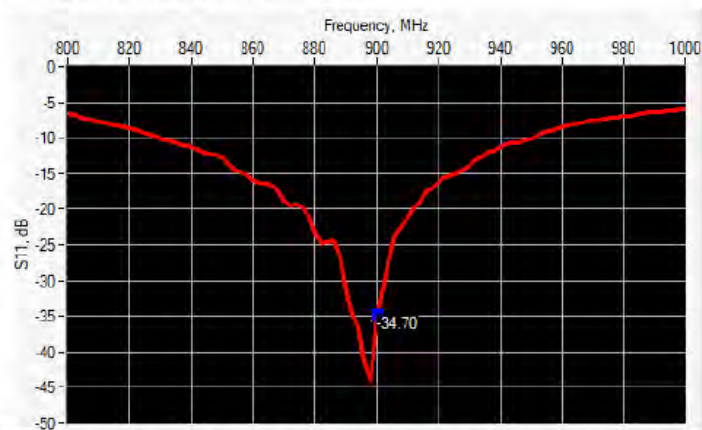

Frequency (MHz)	Return Loss (dB)	Requirement (dB)	Impedance
900	-34.70	-20	51.0 Ω - 1.5 jΩ

6.2 MECHANICAL DIMENSIONS

Frequency MHz	L mm		h mm		d mm	
	required	measured	required	measured	required	measured
300	420.0 ±1 %.		250.0 ±1 %.		6.35 ±1 %.	
450	290.0 ±1 %.		166.7 ±1 %.		6.35 ±1 %.	
750	176.0 ±1 %.		100.0 ±1 %.		6.35 ±1 %.	
835	161.0 ±1 %.		89.8 ±1 %.		3.6 ±1 %.	
900	149.0 ±1 %.	-	83.3 ±1 %.	-	3.6 ±1 %.	-
1450	89.1 ±1 %.		51.7 ±1 %.		3.6 ±1 %.	
1500	80.5 ±1 %.		50.0 ±1 %.		3.6 ±1 %.	
1640	79.0 ±1 %.		45.7 ±1 %.		3.6 ±1 %.	
1750	75.2 ±1 %.		42.9 ±1 %.		3.6 ±1 %.	
1800	72.0 ±1 %.		41.7 ±1 %.		3.6 ±1 %.	
1900	68.0 ±1 %.		39.5 ±1 %.		3.6 ±1 %.	
1950	66.3 ±1 %.		38.5 ±1 %.		3.6 ±1 %.	
2000	64.5 ±1 %.		37.5 ±1 %.		3.6 ±1 %.	
2100	61.0 ±1 %.		35.7 ±1 %.		3.6 ±1 %.	
2300	55.5 ±1 %.		32.6 ±1 %.		3.6 ±1 %.	
2450	51.5 ±1 %.		30.4 ±1 %.		3.6 ±1 %.	



SAR REFERENCE DIPOLE CALIBRATION REPORT

Ref: ACR.60.4.21.MVGB.A

2600	48.5 ±1 %.		28.8 ±1 %.		3.6 ±1 %.	
3000	41.5 ±1 %.		25.0 ±1 %.		3.6 ±1 %.	
3500	37.0±1 %.		26.4 ±1 %.		3.6 ±1 %.	
3700	34.7±1 %.		26.4 ±1 %.		3.6 ±1 %.	

7 VALIDATION MEASUREMENT

The IEEE Std. 1528, FCC KDBs and CEI/IEC 62209 standards state that the system validation measurements must be performed using a reference dipole meeting the fore mentioned return loss and mechanical dimension requirements. The validation measurement must be performed against a liquid filled flat phantom, with the phantom constructed as outlined in the fore mentioned standards. Per the standards, the dipole shall be positioned below the bottom of the phantom, with the dipole length centered and parallel to the longest dimension of the flat phantom, with the top surface of the dipole at the described distance from the bottom surface of the phantom.

7.1 MEASUREMENT CONDITION

Software	OPENSAR V5
Phantom	SN 13/09 SAM68
Probe	SN 41/18 EPG0333
Liquid	Head Liquid Values: ϵ_p' : 39.8 σ : 0.97
Distance between dipole center and liquid	15.0 mm
Area scan resolution	dx=8mm/dy=8mm
Zoon Scan Resolution	dx=8mm/dy=8mm/dz=5mm
Frequency	900900 MHz
Input power	20 dBm
Liquid Temperature	20 +/- 1 °C
Lab Temperature	20 +/- 1 °C
Lab Humidity	30-70 %

7.2 HEAD LIQUID MEASUREMENT

Frequency MHz	Relative permittivity (ϵ_r')		Conductivity (σ) S/m	
	required	measured	required	measured
300	45.3 ±10 %		0.87 ±10 %	
450	43.5 ±10 %		0.87 ±10 %	
750	41.9 ±10 %		0.89 ±10 %	
835	41.5 ±10 %		0.90 ±10 %	
900	41.5 ±10 %	39.8	0.97 ±10 %	0.97
1450	40.5 ±10 %		1.20 ±10 %	
1500	40.4 ±10 %		1.23 ±10 %	
1640	40.2 ±10 %		1.31 ±10 %	
1750	40.1 ±10 %		1.37 ±10 %	
1800	40.0 ±10 %		1.40 ±10 %	
1900	40.0 ±10 %		1.40 ±10 %	
1950	40.0 ±10 %		1.40 ±10 %	
2000	40.0 ±10 %		1.40 ±10 %	



SAR REFERENCE DIPOLE CALIBRATION REPORT

Ref. ACR.60.4.21.MVGB.A

2100	39.8 ±10 %		1.49 ±10 %	
2300	39.5 ±10 %		1.67 ±10 %	
2450	39.2 ±10 %		1.80 ±10 %	
2600	39.0 ±10 %		1.96 ±10 %	
3000	38.5 ±10 %		2.40 ±10 %	
3500	37.9 ±10 %		2.91 ±10 %	

7.3 MEASUREMENT RESULT

The IEEE Std. 1528 and CEI/IEC 62209 standards state that the system validation measurements should produce the SAR values shown below (for phantom thickness of 2 mm), within the uncertainty for the system validation. All SAR values are normalized to 1 W forward power. In bracket, the measured SAR is given with the used input power.

Frequency MHz	1 g SAR (W/kg/W)		10 g SAR (W/kg/W)	
	required	measured	required	measured
300	2.85		1.94	
450	4.58		3.06	
750	8.49		5.55	
835	9.56		6.22	
900	10.9	11.08 (1.11)	6.99	6.81 (0.68)
1450	29		16	
1500	30.5		16.8	
1640	34.2		18.4	
1750	36.4		19.3	
1800	38.4		20.1	
1900	39.7		20.5	
1950	40.5		20.9	
2000	41.1		21.1	
2100	43.6		21.9	
2300	48.7		23.3	
2450	52.4		24	
2600	55.3		24.6	
3000	63.8		25.7	
3500	67.1		25	



SAR REFERENCE DIPOLE CALIBRATION REPORT

Ref: ACR.60.4.21.MVGB.A

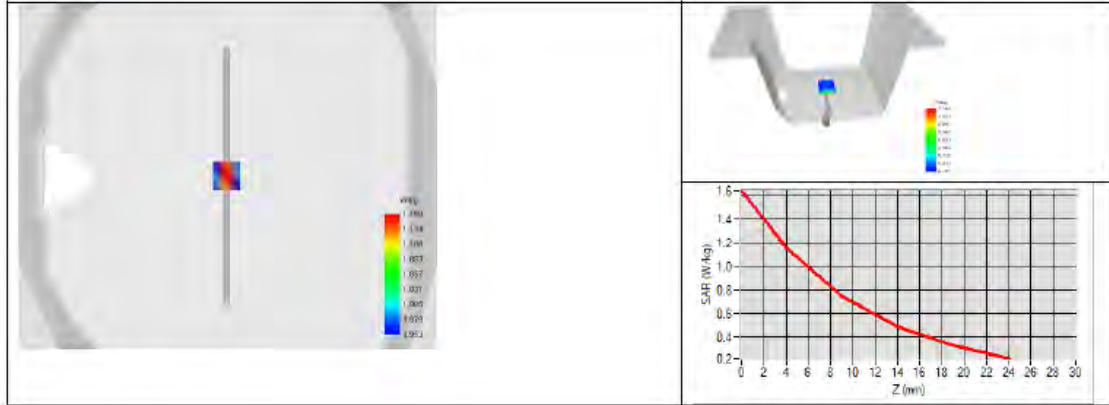



SAR REFERENCE DIPOLE CALIBRATION REPORT

Ref. ACR.60.4.21.MVGB.A

8 LIST OF EQUIPMENT

Equipment Summary Sheet				
Equipment Description	Manufacturer / Model	Identification No.	Current Calibration Date	Next Calibration Date
SAM Phantom	MVG	SN-13/09-SAM68	Validated. No cal required.	Validated. No cal required.
COMOSAR Test Bench	Version 3	NA	Validated. No cal required.	Validated. No cal required.
Network Analyzer	Rohde & Schwarz ZVM	100203	05/2019	05/2022
Network Analyzer – Calibration kit	Rohde & Schwarz ZV-Z235	101223	05/2019	05/2022
Calipers	Mitutoyo	SN 0009732	10/2019	10/2022
Reference Probe	MVG	EPGO333 SN 41/18	05/2020	05/2021
Multimeter	Keithley 2000	1160271	02/2020	02/2023
Signal Generator	Rohde & Schwarz SMB	106589	04/2019	04/2022
Amplifier	Aethercomm	SN 046	Characterized prior to test. No cal required.	Characterized prior to test. No cal required.
Power Meter	NI-USB 5680	170100013	05/2019	05/2022
Directional Coupler	Narda 4216-20	01386	Characterized prior to test. No cal required.	Characterized prior to test. No cal required.
Temperature / Humidity Sensor	Testo 184 H1	44220687	05/2020	05/2023



SAR Reference Dipole Calibration Report

Ref : ACR.60.5.21.MVGB.A

**SHENZHEN NTEK TESTING TECHNOLOGY
CO., LTD.**

**BUILDING E, FENDA SCIENCE PARK, SANWEI
COMMUNITY, XIXIANG STREET,
BAO'AN DISTRICT, SHENZHEN GUANGDONG, CHINA**

MVG COMOSAR REFERENCE DIPOLE

FREQUENCY: 1800 MHZ

SERIAL NO.: SN 03/15 DIP1G800-349

Calibrated at MVG

Z.I. de la pointe du diable

Technopôle Brest Iroise – 295 avenue Alexis de Rochon

29280 PLOUZANE - FRANCE

Calibration date: 03/01/2021



Accreditations #2-6789 and #2-6814
Scope available on www.cofrac.fr

Summary:

This document presents the method and results from an accredited SAR reference dipole calibration performed at MVG, using the COMOSAR test bench. The test results covered by accreditation are traceable to the International System of Units (SI).



SAR REFERENCE DIPOLE CALIBRATION REPORT

Ref. ACR.60.5.21.MVGB.A

	<i>Name</i>	<i>Function</i>	<i>Date</i>	<i>Signature</i>
<i>Prepared by :</i>	Jérôme Luc	Technical Manager	3/1/2021	<i>JL</i>
<i>Checked by :</i>	Jérôme Luc	Technical Manager	3/1/2021	<i>JL</i>
<i>Approved by :</i>	Yann Toutain	Laboratory Director	3/1/2021	<i>Yann Toutain</i>

2021.03.0
1 13:10:48
+01'00'

	<i>Customer Name</i>
<i>Distribution :</i>	SHENZHEN NTEK TESTING TECHNOLOGY CO., LTD.

<i>Issue</i>	<i>Name</i>	<i>Date</i>	<i>Modifications</i>
A	Jérôme Luc	3/1/2021	Initial release



SAR REFERENCE DIPOLE CALIBRATION REPORT

Ref. ACR.60.5.21.MVGB.A

TABLE OF CONTENTS

1	Introduction.....	4
2	Device Under Test	4
3	Product Description	4
3.1	General Information	4
4	Measurement Method	5
4.1	Return Loss Requirements	5
4.2	Mechanical Requirements	5
5	Measurement Uncertainty.....	5
5.1	Return Loss	5
5.2	Dimension Measurement	5
5.3	Validation Measurement	5
6	Calibration Measurement Results.....	6
6.1	Return Loss and Impedance	6
6.2	Mechanical Dimensions	6
7	Validation measurement	7
7.1	Measurement Condition	7
7.2	Head Liquid Measurement	7
7.3	Measurement Result	8
8	List of Equipment	10



SAR REFERENCE DIPOLE CALIBRATION REPORT

Ref. ACR.60.5.21.MVGB.A

1 INTRODUCTION

This document contains a summary of the requirements set forth by the IEEE 1528, FCC KDBs and CEI/IEC 62209 standards for reference dipoles used for SAR measurement system validations and the measurements that were performed to verify that the product complies with the fore mentioned standards.

2 DEVICE UNDER TEST

Device Under Test	
Device Type	COMOSAR 1800 MHz REFERENCE DIPOLE
Manufacturer	MVG
Model	SID1800
Serial Number	SN 03/15 DIP1G800-349
Product Condition (new / used)	Used

3 PRODUCT DESCRIPTION

3.1 GENERAL INFORMATION

MVG’s COMOSAR Validation Dipoles are built in accordance to the IEEE 1528, FCC KDBs and CEI/IEC 62209 standards. The product is designed for use with the COMOSAR test bench only.



Figure 1 – MVG COMOSAR Validation Dipole



SAR REFERENCE DIPOLE CALIBRATION REPORT

Ref. ACR.60.5.21.MVGB.A

4 MEASUREMENT METHOD

The IEEE 1528, FCC KDBs and CEI/IEC 62209 standards provide requirements for reference dipoles used for system validation measurements. The following measurements were performed to verify that the product complies with the fore mentioned standards.

4.1 RETURN LOSS REQUIREMENTS

The dipole used for SAR system validation measurements and checks must have a return loss of -20 dB or better. The return loss measurement shall be performed against a liquid filled flat phantom, with the phantom constructed as outlined in the fore mentioned standards. A direct method is used with a network analyser and its calibration kit, both with a valid ISO17025 calibration.

4.2 MECHANICAL REQUIREMENTS

The IEEE Std. 1528 and CEI/IEC 62209 standards specify the mechanical components and dimensions of the validation dipoles, with the dimension's frequency and phantom shell thickness dependent. The COMOSAR test bench employs a 2 mm phantom shell thickness therefore the dipoles sold for use with the COMOSAR test bench comply with the requirements set forth for a 2 mm phantom shell thickness. A direct method is used with a ISO17025 calibrated caliper.

5 MEASUREMENT UNCERTAINTY

All uncertainties listed below represent an expanded uncertainty expressed at approximately the 95% confidence level using a coverage factor of k=2, traceable to the Internationally Accepted Guides to Measurement Uncertainty.

5.1 RETURN LOSS

The following uncertainties apply to the return loss measurement:

Frequency band	Expanded Uncertainty on Return Loss
400-6000MHz	0.08 LIN

5.2 DIMENSION MEASUREMENT

The following uncertainties apply to the dimension measurements:

Length (mm)	Expanded Uncertainty on Length
0 - 300	0.20 mm
300 - 450	0.44 mm

5.3 VALIDATION MEASUREMENT

The guidelines outlined in the IEEE 1528, FCC KDBs, CENELEC EN50361 and CEI/IEC 62209 standards were followed to generate the measurement uncertainty for validation measurements.

Scan Volume	Expanded Uncertainty



SAR REFERENCE DIPOLE CALIBRATION REPORT

Ref. ACR.60.5.21.MVGB.A

1 g	19 % (SAR)
10 g	19 % (SAR)

6 CALIBRATION MEASUREMENT RESULTS

6.1 RETURN LOSS AND IMPEDANCE

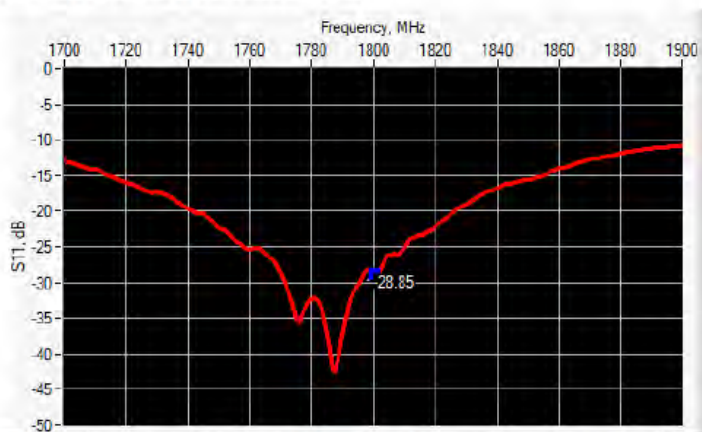

Frequency (MHz)	Return Loss (dB)	Requirement (dB)	Impedance
1800	-28.85	-20	47.9 Ω + 2.9 jΩ

6.2 MECHANICAL DIMENSIONS

Frequency MHz	L mm		h mm		d mm	
	required	measured	required	measured	required	measured
300	420.0 ±1 %.		250.0 ±1 %.		6.35 ±1 %.	
450	290.0 ±1 %.		166.7 ±1 %.		6.35 ±1 %.	
750	176.0 ±1 %.		100.0 ±1 %.		6.35 ±1 %.	
835	161.0 ±1 %.		89.8 ±1 %.		3.6 ±1 %.	
900	149.0 ±1 %.		83.3 ±1 %.		3.6 ±1 %.	
1450	89.1 ±1 %.		51.7 ±1 %.		3.6 ±1 %.	
1500	80.5 ±1 %.		50.0 ±1 %.		3.6 ±1 %.	
1640	79.0 ±1 %.		45.7 ±1 %.		3.6 ±1 %.	
1750	75.2 ±1 %.		42.9 ±1 %.		3.6 ±1 %.	
1800	72.0 ±1 %.	-	41.7 ±1 %.	-	3.6 ±1 %.	-
1900	68.0 ±1 %.		39.5 ±1 %.		3.6 ±1 %.	
1950	66.3 ±1 %.		38.5 ±1 %.		3.6 ±1 %.	
2000	64.5 ±1 %.		37.5 ±1 %.		3.6 ±1 %.	
2100	61.0 ±1 %.		35.7 ±1 %.		3.6 ±1 %.	
2300	55.5 ±1 %.		32.6 ±1 %.		3.6 ±1 %.	
2450	51.5 ±1 %.		30.4 ±1 %.		3.6 ±1 %.	



SAR REFERENCE DIPOLE CALIBRATION REPORT

Ref. ACR.60.5.21.MVGB.A

2600	48.5 ±1 %.		28.8 ±1 %.		3.6 ±1 %.	
3000	41.5 ±1 %.		25.0 ±1 %.		3.6 ±1 %.	
3500	37.0±1 %.		26.4 ±1 %.		3.6 ±1 %.	
3700	34.7±1 %.		26.4 ±1 %.		3.6 ±1 %.	

7 VALIDATION MEASUREMENT

The IEEE Std. 1528, FCC KDBs and CEI/IEC 62209 standards state that the system validation measurements must be performed using a reference dipole meeting the fore mentioned return loss and mechanical dimension requirements. The validation measurement must be performed against a liquid filled flat phantom, with the phantom constructed as outlined in the fore mentioned standards. Per the standards, the dipole shall be positioned below the bottom of the phantom, with the dipole length centered and parallel to the longest dimension of the flat phantom, with the top surface of the dipole at the described distance from the bottom surface of the phantom.

7.1 MEASUREMENT CONDITION

Software	OPENSAR V5
Phantom	SN 13/09 SAM68
Probe	SN 41/18 EPG0333
Liquid	Head Liquid Values: eps' : 43.7 sigma : 1.34
Distance between dipole center and liquid	10.0 mm
Area scan resolution	dx=8mm/dy=8mm
Zoon Scan Resolution	dx=8mm/dy=8mm/dz=5mm
Frequency	18001800 MHz
Input power	20 dBm
Liquid Temperature	20 +/- 1 °C
Lab Temperature	20 +/- 1 °C
Lab Humidity	30-70 %

7.2 HEAD LIQUID MEASUREMENT

Frequency MHz	Relative permittivity (ε _r)		Conductivity (σ) S/m	
	required	measured	required	measured
300	45.3 ±10 %		0.87 ±10 %	
450	43.5 ±10 %		0.87 ±10 %	
750	41.9 ±10 %		0.89 ±10 %	
835	41.5 ±10 %		0.90 ±10 %	
900	41.5 ±10 %		0.97 ±10 %	
1450	40.5 ±10 %		1.20 ±10 %	
1500	40.4 ±10 %		1.23 ±10 %	
1640	40.2 ±10 %		1.31 ±10 %	
1750	40.1 ±10 %		1.37 ±10 %	
1800	40.0 ±10 %	43.7	1.40 ±10 %	1.34
1900	40.0 ±10 %		1.40 ±10 %	
1950	40.0 ±10 %		1.40 ±10 %	
2000	40.0 ±10 %		1.40 ±10 %	



SAR REFERENCE DIPOLE CALIBRATION REPORT

Ref. ACR.60.5.21.MVGB.A

2100	39.8 ±10 %		1.49 ±10 %	
2300	39.5 ±10 %		1.67 ±10 %	
2450	39.2 ±10 %		1.80 ±10 %	
2600	39.0 ±10 %		1.96 ±10 %	
3000	38.5 ±10 %		2.40 ±10 %	
3500	37.9 ±10 %		2.91 ±10 %	

7.3 MEASUREMENT RESULT

The IEEE Std. 1528 and CEI/IEC 62209 standards state that the system validation measurements should produce the SAR values shown below (for phantom thickness of 2 mm), within the uncertainty for the system validation. All SAR values are normalized to 1 W forward power. In bracket, the measured SAR is given with the used input power.

Frequency MHz	1 g SAR (W/kg/W)		10 g SAR (W/kg/W)	
	required	measured	required	measured
300	2.85		1.94	
450	4.58		3.06	
750	8.49		5.55	
835	9.56		6.22	
900	10.9		6.99	
1450	29		16	
1500	30.5		16.8	
1640	34.2		18.4	
1750	36.4		19.3	
1800	38.4	37.96 (3.80)	20.1	19.81 (1.98)
1900	39.7		20.5	
1950	40.5		20.9	
2000	41.1		21.1	
2100	43.6		21.9	
2300	48.7		23.3	
2450	52.4		24	
2600	55.3		24.6	
3000	63.8		25.7	
3500	67.1		25	



SAR REFERENCE DIPOLE CALIBRATION REPORT

Ref. ACR.60.5.21.MVGB.A

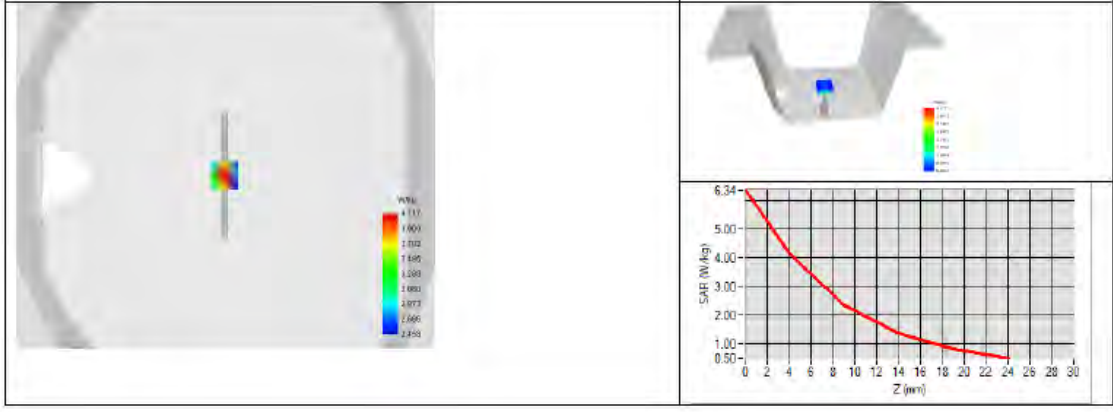



SAR REFERENCE DIPOLE CALIBRATION REPORT

Ref: ACR.60.5.21.MVGB.A

8 LIST OF EQUIPMENT

Equipment Summary Sheet				
Equipment Description	Manufacturer / Model	Identification No.	Current Calibration Date	Next Calibration Date
SAM Phantom	MVG	SN-13/09-SAM68	Validated. No cal required.	Validated. No cal required.
COMOSAR Test Bench	Version 3	NA	Validated. No cal required.	Validated. No cal required.
Network Analyzer	Rohde & Schwarz ZVM	100203	05/2019	05/2022
Network Analyzer – Calibration kit	Rohde & Schwarz ZV-Z235	101223	05/2019	05/2022
Calipers	Mitutoyo	SN 0009732	10/2019	10/2022
Reference Probe	MVG	EPGO333 SN 41/18	05/2020	05/2021
Multimeter	Keithley 2000	1160271	02/2020	02/2023
Signal Generator	Rohde & Schwarz SMB	106589	04/2019	04/2022
Amplifier	Aethercomm	SN 046	Characterized prior to test. No cal required.	Characterized prior to test. No cal required.
Power Meter	NI-USB 5680	170100013	05/2019	05/2022
Directional Coupler	Narda 4216-20	01386	Characterized prior to test. No cal required.	Characterized prior to test. No cal required.
Temperature / Humidity Sensor	Testo 184 H1	44220687	05/2020	05/2023



SAR Reference Dipole Calibration Report

Ref: ACR.60.7.21.MVGB.A

SHENZHEN NTEK TESTING TECHNOLOGY CO., LTD.

BUILDING E, FENDA SCIENCE PARK, SANWEI
COMMUNITY, XIXIANG STREET,
BAO'AN DISTRICT, SHENZHEN GUANGDONG, CHINA
MVG COMOSAR REFERENCE DIPOLE

FREQUENCY: 2000 MHZ

SERIAL NO.: SN 03/15 DIP2G000-351

Calibrated at MVG

Z.I. de la pointe du diable

Technopôle Brest Iroise – 295 avenue Alexis de Rochon

29280 PLOUZANE - FRANCE

Calibration date: 03/01/2021



Accreditations #2-6789 and #2-6814
Scope available on www.cofrac.fr

Summary:

This document presents the method and results from an accredited SAR reference dipole calibration performed at MVG, using the COMOSAR test bench. The test results covered by accreditation are traceable to the International System of Units (SI).



SAR REFERENCE DIPOLE CALIBRATION REPORT

Ref: ACR.60.7.21.MVGB.A

	Name	Function	Date	Signature
Prepared by :	Jérôme Luc	Technical Manager	3/1/2021	<i>JL</i>
Checked by :	Jérôme Luc	Technical Manager	3/1/2021	<i>JL</i>
Approved by :	Yann Toutain	Laboratory Director	3/1/2021	<i>Yann Toutain</i>

2021.03.01 13:12:43 +01'00'

	Customer Name
Distribution :	SHENZHEN NTEK TESTING TECHNOLOGY CO., LTD.

Issue	Name	Date	Modifications
A	Jérôme Luc	3/1/2021	Initial release



SAR REFERENCE DIPOLE CALIBRATION REPORT

Ref: ACR.60.7.21.MVGB.A

TABLE OF CONTENTS

1	Introduction.....	4
2	Device Under Test	4
3	Product Description	4
3.1	General Information	4
4	Measurement Method	5
4.1	Return Loss Requirements	5
4.2	Mechanical Requirements	5
5	Measurement Uncertainty.....	5
5.1	Return Loss	5
5.2	Dimension Measurement	5
5.3	Validation Measurement	5
6	Calibration Measurement Results.....	6
6.1	Return Loss and Impedance	6
6.2	Mechanical Dimensions	6
7	Validation measurement	7
7.1	Measurement Condition	7
7.2	Head Liquid Measurement	7
7.3	Measurement Result	8
8	List of Equipment	10



SAR REFERENCE DIPOLE CALIBRATION REPORT

Ref: ACR.60.7.21.MVGB.A

1 INTRODUCTION

This document contains a summary of the requirements set forth by the IEEE 1528, FCC KDBs and CEI/IEC 62209 standards for reference dipoles used for SAR measurement system validations and the measurements that were performed to verify that the product complies with the fore mentioned standards.

2 DEVICE UNDER TEST

Device Under Test	
Device Type	COMOSAR 2000 MHz REFERENCE DIPOLE
Manufacturer	MVG
Model	SID2000
Serial Number	SN 03/15 DIP2G000-351
Product Condition (new / used)	Used

3 PRODUCT DESCRIPTION

3.1 GENERAL INFORMATION

MVG’s COMOSAR Validation Dipoles are built in accordance to the IEEE 1528, FCC KDBs and CEI/IEC 62209 standards. The product is designed for use with the COMOSAR test bench only.



Figure 1 – MVG COMOSAR Validation Dipole



SAR REFERENCE DIPOLE CALIBRATION REPORT

Ref. ACR.60.7.21.MVGB.A

4 MEASUREMENT METHOD

The IEEE 1528, FCC KDBs and CEI/IEC 62209 standards provide requirements for reference dipoles used for system validation measurements. The following measurements were performed to verify that the product complies with the fore mentioned standards.

4.1 RETURN LOSS REQUIREMENTS

The dipole used for SAR system validation measurements and checks must have a return loss of -20 dB or better. The return loss measurement shall be performed against a liquid filled flat phantom, with the phantom constructed as outlined in the fore mentioned standards. A direct method is used with a network analyser and its calibration kit, both with a valid ISO17025 calibration.

4.2 MECHANICAL REQUIREMENTS

The IEEE Std. 1528 and CEI/IEC 62209 standards specify the mechanical components and dimensions of the validation dipoles, with the dimension's frequency and phantom shell thickness dependent. The COMOSAR test bench employs a 2 mm phantom shell thickness therefore the dipoles sold for use with the COMOSAR test bench comply with the requirements set forth for a 2 mm phantom shell thickness. A direct method is used with a ISO17025 calibrated caliper.

5 MEASUREMENT UNCERTAINTY

All uncertainties listed below represent an expanded uncertainty expressed at approximately the 95% confidence level using a coverage factor of k=2, traceable to the Internationally Accepted Guides to Measurement Uncertainty.

5.1 RETURN LOSS

The following uncertainties apply to the return loss measurement:

Frequency band	Expanded Uncertainty on Return Loss
400-6000MHz	0.08 LIN

5.2 DIMENSION MEASUREMENT

The following uncertainties apply to the dimension measurements:

Length (mm)	Expanded Uncertainty on Length
0 - 300	0.20 mm
300 - 450	0.44 mm

5.3 VALIDATION MEASUREMENT

The guidelines outlined in the IEEE 1528, FCC KDBs, CENELEC EN50361 and CEI/IEC 62209 standards were followed to generate the measurement uncertainty for validation measurements.

Scan Volume	Expanded Uncertainty



SAR REFERENCE DIPOLE CALIBRATION REPORT

Ref: ACR.60.7.21.MVGB.A

1 g	19 % (SAR)
10 g	19 % (SAR)

6 CALIBRATION MEASUREMENT RESULTS

6.1 RETURN LOSS AND IMPEDANCE

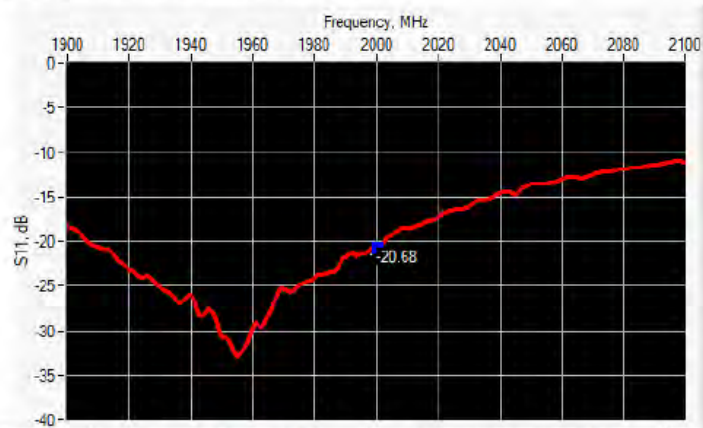

Frequency (MHz)	Return Loss (dB)	Requirement (dB)	Impedance
2000	-20.68	-20	60.3 Ω + 0.1 jΩ

6.2 MECHANICAL DIMENSIONS

Frequency MHz	L mm		h mm		d mm	
	required	measured	required	measured	required	measured
300	420.0 ±1 %		250.0 ±1 %		6.35 ±1 %	
450	290.0 ±1 %		166.7 ±1 %		6.35 ±1 %	
750	176.0 ±1 %		100.0 ±1 %		6.35 ±1 %	
835	161.0 ±1 %		89.8 ±1 %		3.6 ±1 %	
900	149.0 ±1 %		83.3 ±1 %		3.6 ±1 %	
1450	89.1 ±1 %		51.7 ±1 %		3.6 ±1 %	
1500	80.5 ±1 %		50.0 ±1 %		3.6 ±1 %	
1640	79.0 ±1 %		45.7 ±1 %		3.6 ±1 %	
1750	75.2 ±1 %		42.9 ±1 %		3.6 ±1 %	
1800	72.0 ±1 %		41.7 ±1 %		3.6 ±1 %	
1900	68.0 ±1 %		39.5 ±1 %		3.6 ±1 %	
1950	66.3 ±1 %		38.5 ±1 %		3.6 ±1 %	
2000	64.5 ±1 %	-	37.5 ±1 %	-	3.6 ±1 %	-
2100	61.0 ±1 %		35.7 ±1 %		3.6 ±1 %	
2300	55.5 ±1 %		32.6 ±1 %		3.6 ±1 %	
2450	51.5 ±1 %		30.4 ±1 %		3.6 ±1 %	



SAR REFERENCE DIPOLE CALIBRATION REPORT

Ref: ACR.60.7.21.MVGB.A

2600	48.5 ±1 %.		28.8 ±1 %.		3.6 ±1 %.	
3000	41.5 ±1 %.		25.0 ±1 %.		3.6 ±1 %.	
3500	37.0±1 %.		26.4 ±1 %.		3.6 ±1 %.	
3700	34.7±1 %.		26.4 ±1 %.		3.6 ±1 %.	

7 VALIDATION MEASUREMENT

The IEEE Std. 1528, FCC KDBs and CEI/IEC 62209 standards state that the system validation measurements must be performed using a reference dipole meeting the fore mentioned return loss and mechanical dimension requirements. The validation measurement must be performed against a liquid filled flat phantom, with the phantom constructed as outlined in the fore mentioned standards. Per the standards, the dipole shall be positioned below the bottom of the phantom, with the dipole length centered and parallel to the longest dimension of the flat phantom, with the top surface of the dipole at the described distance from the bottom surface of the phantom.

7.1 MEASUREMENT CONDITION

Software	OPENSAR V5
Phantom	SN 13/09 SAM68
Probe	SN 41/18 EPGO333
Liquid	Head Liquid Values: eps' : 43.1 sigma : 1.48
Distance between dipole center and liquid	10.0 mm
Area scan resolution	dx=8mm/dy=8mm
Zoon Scan Resolution	dx=5mm/dy=5mm/dz=5mm
Frequency	20002000 MHz
Input power	20 dBm
Liquid Temperature	20 +/- 1 °C
Lab Temperature	20 +/- 1 °C
Lab Humidity	30-70 %

7.2 HEAD LIQUID MEASUREMENT

Frequency MHz	Relative permittivity (ε _r)		Conductivity (σ) S/m	
	required	measured	required	measured
300	45.3 ±10 %		0.87 ±10 %	
450	43.5 ±10 %		0.87 ±10 %	
750	41.9 ±10 %		0.89 ±10 %	
835	41.5 ±10 %		0.90 ±10 %	
900	41.5 ±10 %		0.97 ±10 %	
1450	40.5 ±10 %		1.20 ±10 %	
1500	40.4 ±10 %		1.23 ±10 %	
1640	40.2 ±10 %		1.31 ±10 %	
1750	40.1 ±10 %		1.37 ±10 %	
1800	40.0 ±10 %		1.40 ±10 %	
1900	40.0 ±10 %		1.40 ±10 %	
1950	40.0 ±10 %		1.40 ±10 %	
2000	40.0 ±10 %	43.1	1.40 ±10 %	1.48



SAR REFERENCE DIPOLE CALIBRATION REPORT

Ref. ACR.60.7.21.MVGB.A

2100	39.8 ±10 %		1.49 ±10 %	
2300	39.5 ±10 %		1.67 ±10 %	
2450	39.2 ±10 %		1.80 ±10 %	
2600	39.0 ±10 %		1.96 ±10 %	
3000	38.5 ±10 %		2.40 ±10 %	
3500	37.9 ±10 %		2.91 ±10 %	

7.3 MEASUREMENT RESULT

The IEEE Std. 1528 and CEI/IEC 62209 standards state that the system validation measurements should produce the SAR values shown below (for phantom thickness of 2 mm), within the uncertainty for the system validation. All SAR values are normalized to 1 W forward power. In bracket, the measured SAR is given with the used input power.

Frequency MHz	1 g SAR (W/kg/W)		10 g SAR (W/kg/W)	
	required	measured	required	measured
300	2.85		1.94	
450	4.58		3.06	
750	8.49		5.55	
835	9.56		6.22	
900	10.9		6.99	
1450	29		16	
1500	30.5		16.8	
1640	34.2		18.4	
1750	36.4		19.3	
1800	38.4		20.1	
1900	39.7		20.5	
1950	40.5		20.9	
2000	41.1	41.26 (4.13)	21.1	20.52 (2.05)
2100	43.6		21.9	
2300	48.7		23.3	
2450	52.4		24	
2600	55.3		24.6	
3000	63.8		25.7	
3500	67.1		25	



SAR REFERENCE DIPOLE CALIBRATION REPORT

Ref. ACR.60.7.21.MVGB.A

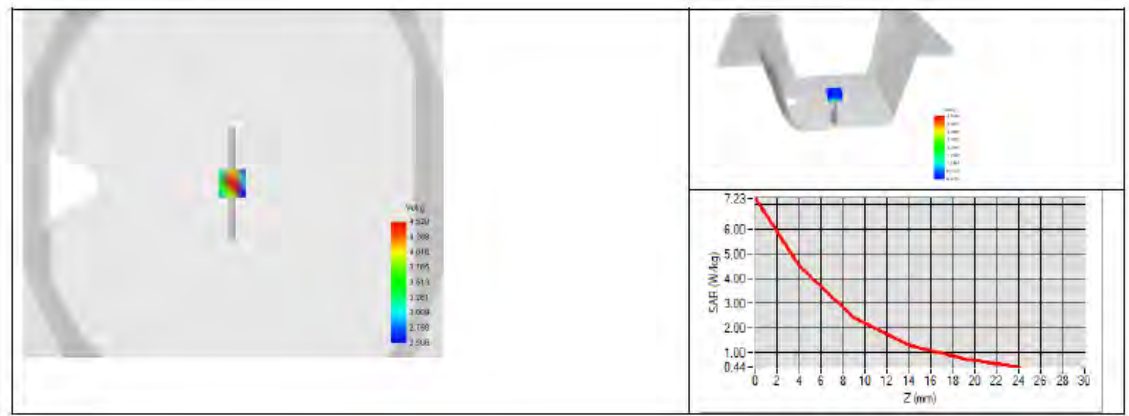



SAR REFERENCE DIPOLE CALIBRATION REPORT

Ref. ACR.60.7.21.MVGB.A

8 LIST OF EQUIPMENT

Equipment Summary Sheet				
Equipment Description	Manufacturer / Model	Identification No.	Current Calibration Date	Next Calibration Date
SAM Phantom	MVG	SN-13/09-SAM68	Validated. No cal required.	Validated. No cal required.
COMOSAR Test Bench	Version 3	NA	Validated. No cal required.	Validated. No cal required.
Network Analyzer	Rohde & Schwarz ZVM	100203	05/2019	05/2022
Network Analyzer – Calibration kit	Rohde & Schwarz ZV-Z235	101223	05/2019	05/2022
Calipers	Mitutoyo	SN 0009732	10/2019	10/2022
Reference Probe	MVG	EPGO333 SN 41/18	05/2020	05/2021
Multimeter	Keithley 2000	1160271	02/2020	02/2023
Signal Generator	Rohde & Schwarz SMB	106589	04/2019	04/2022
Amplifier	Aethercomm	SN 046	Characterized prior to test. No cal required.	Characterized prior to test. No cal required.
Power Meter	NI-USB 5680	170100013	05/2019	05/2022
Directional Coupler	Narda 4216-20	01386	Characterized prior to test. No cal required.	Characterized prior to test. No cal required.
Temperature / Humidity Sensor	Testo 184 H1	44220687	05/2020	05/2023



SAR Reference Dipole Calibration Report

Ref : ACR.60.11.21.MVGB.A

SHENZHEN NTEK TESTING TECHNOLOGY CO., LTD.

**BUILDING E, FENDA SCIENCE PARK, SANWEI
COMMUNITY, XIXIANG STREET,
BAO'AN DISTRICT, SHENZHEN GUANGDONG, CHINA**

MVG COMOSAR REFERENCE DIPOLE

FREQUENCY: 2300 MHZ

SERIAL NO.: SN 03/16 DIP2G300-358

Calibrated at MVG

Z.I. de la pointe du diable

**Technopôle Brest Iroise – 295 avenue Alexis de Rochon
29280 PLOUZANE - FRANCE**

Calibration date: 03/01/2021



Accreditations #2-6789 and #2-6814
Scope available on www.cofrac.fr

Summary:

This document presents the method and results from an accredited SAR reference dipole calibration performed at MVG, using the COMOSAR test bench. The test results covered by accreditation are traceable to the International System of Units (SI).



SAR REFERENCE DIPOLE CALIBRATION REPORT

Ref. ACR.60.11.21.MVGB A

	<i>Name</i>	<i>Function</i>	<i>Date</i>	<i>Signature</i>
<i>Prepared by :</i>	Jérôme LUC	Technical Manager	3/1/2021	<i>JL</i>
<i>Checked by :</i>	Jérôme LUC	Technical Manager	3/1/2021	<i>JL</i>
<i>Approved by :</i>	Yann Toutain	Laboratory Director	3/1/2021	<i>Yann Toutain</i>

2021.03.0
1 13:16:13
+01'00'

	<i>Customer Name</i>
<i>Distribution :</i>	SHENZHEN NTEK TESTING TECHNOLOGY CO., LTD.

<i>Issue</i>	<i>Name</i>	<i>Date</i>	<i>Modifications</i>
A	Jérôme LE GALL	3/1/2021	Initial release



SAR REFERENCE DIPOLE CALIBRATION REPORT

Ref. ACR.60.11.21.MVGB.A

TABLE OF CONTENTS

1	Introduction.....	4
2	Device Under Test	4
3	Product Description	4
3.1	General Information	4
4	Measurement Method	5
4.1	Return Loss Requirements	5
4.2	Mechanical Requirements	5
5	Measurement Uncertainty.....	5
5.1	Return Loss	5
5.2	Dimension Measurement	5
5.3	Validation Measurement	5
6	Calibration Measurement Results.....	6
6.1	Return Loss and Impedance	6
6.2	Mechanical Dimensions	6
7	Validation measurement	7
7.1	Measurement Condition	7
7.2	Head Liquid Measurement	7
7.3	Measurement Result	8
8	List of Equipment	10



SAR REFERENCE DIPOLE CALIBRATION REPORT

Ref. ACR.60.11.21.MVGB.A

1 INTRODUCTION

This document contains a summary of the requirements set forth by the IEEE 1528, FCC KDBs and CEI/IEC 62209 standards for reference dipoles used for SAR measurement system validations and the measurements that were performed to verify that the product complies with the fore mentioned standards.

2 DEVICE UNDER TEST

Device Under Test	
Device Type	COMOSAR 2300 MHz REFERENCE DIPOLE
Manufacturer	MVG
Model	SID2300
Serial Number	SN 03/15 DIP2G300-358
Product Condition (new / used)	Used

3 PRODUCT DESCRIPTION

3.1 GENERAL INFORMATION

MVG’s COMOSAR Validation Dipoles are built in accordance to the IEEE 1528, FCC KDBs and CEI/IEC 62209 standards. The product is designed for use with the COMOSAR test bench only.



Figure 1 – MVG COMOSAR Validation Dipole



SAR REFERENCE DIPOLE CALIBRATION REPORT

Ref. ACR.60.11.21.MVGB.A

4 MEASUREMENT METHOD

The IEEE 1528, FCC KDBs and CEI/IEC 62209 standards provide requirements for reference dipoles used for system validation measurements. The following measurements were performed to verify that the product complies with the fore mentioned standards.

4.1 RETURN LOSS REQUIREMENTS

The dipole used for SAR system validation measurements and checks must have a return loss of -20 dB or better. The return loss measurement shall be performed against a liquid filled flat phantom, with the phantom constructed as outlined in the fore mentioned standards. A direct method is used with a network analyser and its calibration kit, both with a valid ISO17025 calibration.

4.2 MECHANICAL REQUIREMENTS

The IEEE Std. 1528 and CEI/IEC 62209 standards specify the mechanical components and dimensions of the validation dipoles, with the dimension's frequency and phantom shell thickness dependent. The COMOSAR test bench employs a 2 mm phantom shell thickness therefore the dipoles sold for use with the COMOSAR test bench comply with the requirements set forth for a 2 mm phantom shell thickness. A direct method is used with a ISO17025 calibrated caliper.

5 MEASUREMENT UNCERTAINTY

All uncertainties listed below represent an expanded uncertainty expressed at approximately the 95% confidence level using a coverage factor of k=2, traceable to the Internationally Accepted Guides to Measurement Uncertainty.

5.1 RETURN LOSS

The following uncertainties apply to the return loss measurement:

Frequency band	Expanded Uncertainty on Return Loss
400-6000MHz	0.08 LIN

5.2 DIMENSION MEASUREMENT

The following uncertainties apply to the dimension measurements:

Length (mm)	Expanded Uncertainty on Length
0 - 300	0.20 mm
300 - 450	0.44 mm

5.3 VALIDATION MEASUREMENT

The guidelines outlined in the IEEE 1528, FCC KDBs, CENELEC EN50361 and CEI/IEC 62209 standards were followed to generate the measurement uncertainty for validation measurements.

Scan Volume	Expanded Uncertainty



SAR REFERENCE DIPOLE CALIBRATION REPORT

Ref. ACR.60.11.21.MVGB.A

1 g	19 % (SAR)
10 g	19 % (SAR)

6 CALIBRATION MEASUREMENT RESULTS

6.1 RETURN LOSS AND IMPEDANCE

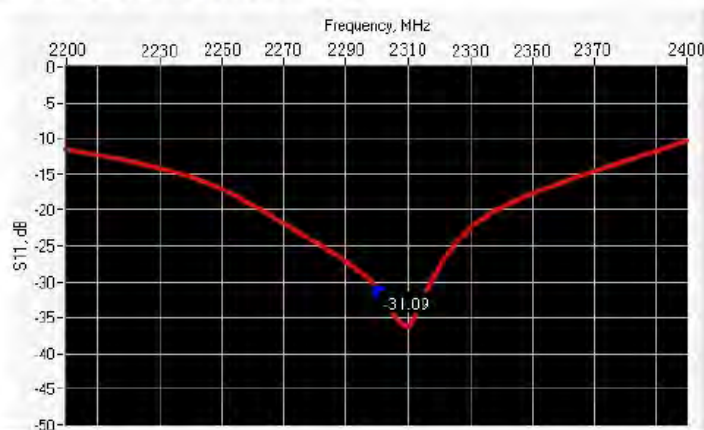

Frequency (MHz)	Return Loss (dB)	Requirement (dB)	Impedance
2300	-31.09	-20	56.3 Ω - 2.9 jΩ

6.2 MECHANICAL DIMENSIONS

Frequency MHz	L mm		h mm		d mm	
	required	measured	required	measured	required	measured
300	420.0 ±1 %		250.0 ±1 %		6.35 ±1 %	
450	290.0 ±1 %		166.7 ±1 %		6.35 ±1 %	
750	176.0 ±1 %		100.0 ±1 %		6.35 ±1 %	
835	161.0 ±1 %		89.8 ±1 %		3.6 ±1 %	
900	149.0 ±1 %		83.3 ±1 %		3.6 ±1 %	
1450	89.1 ±1 %		51.7 ±1 %		3.6 ±1 %	
1500	80.5 ±1 %		50.0 ±1 %		3.6 ±1 %	
1640	79.0 ±1 %		45.7 ±1 %		3.6 ±1 %	
1750	75.2 ±1 %		42.9 ±1 %		3.6 ±1 %	
1800	72.0 ±1 %		41.7 ±1 %		3.6 ±1 %	
1900	68.0 ±1 %		39.5 ±1 %		3.6 ±1 %	
1950	66.3 ±1 %		38.5 ±1 %		3.6 ±1 %	
2000	64.5 ±1 %		37.5 ±1 %		3.6 ±1 %	
2100	61.0 ±1 %		35.7 ±1 %		3.6 ±1 %	
2300	55.5 ±1 %	-	32.6 ±1 %	-	3.6 ±1 %	-
2450	51.5 ±1 %		30.4 ±1 %		3.6 ±1 %	



SAR REFERENCE DIPOLE CALIBRATION REPORT

Ref: ACR.60.11.21.MVGB.A

2600	48.5 ±1 %.		28.8 ±1 %.		3.6 ±1 %.	
3000	41.5 ±1 %.		25.0 ±1 %.		3.6 ±1 %.	
3500	37.0±1 %.		26.4 ±1 %.		3.6 ±1 %.	
3700	34.7±1 %.		26.4 ±1 %.		3.6 ±1 %.	

7 VALIDATION MEASUREMENT

The IEEE Std. 1528, FCC KDBs and CEI/IEC 62209 standards state that the system validation measurements must be performed using a reference dipole meeting the fore mentioned return loss and mechanical dimension requirements. The validation measurement must be performed against a liquid filled flat phantom, with the phantom constructed as outlined in the fore mentioned standards. Per the standards, the dipole shall be positioned below the bottom of the phantom, with the dipole length centered and parallel to the longest dimension of the flat phantom, with the top surface of the dipole at the described distance from the bottom surface of the phantom.

7.1 MEASUREMENT CONDITION

Software	OPENSAR V5
Phantom	SN 13/09 SAM68
Probe	SN 41/18 EPGO333
Liquid	Head Liquid Values: eps' : 42.0 sigma : 1.80
Distance between dipole center and liquid	10.0 mm
Area scan resolution	dx=8mm/dy=8mm
Zoon Scan Resolution	dx=5mm/dy=5mm/dz=5mm
Frequency	23002300 MHz
Input power	20 dBm
Liquid Temperature	20 +/- 1 °C
Lab Temperature	20 +/- 1 °C
Lab Humidity	30-70 %

7.2 HEAD LIQUID MEASUREMENT

Frequency MHz	Relative permittivity (ε _r)		Conductivity (σ) S/m	
	required	measured	required	measured
300	45.3 ±10 %		0.87 ±10 %	
450	43.5 ±10 %		0.87 ±10 %	
750	41.9 ±10 %		0.89 ±10 %	
835	41.5 ±10 %		0.90 ±10 %	
900	41.5 ±10 %		0.97 ±10 %	
1450	40.5 ±10 %		1.20 ±10 %	
1500	40.4 ±10 %		1.23 ±10 %	
1640	40.2 ±10 %		1.31 ±10 %	
1750	40.1 ±10 %		1.37 ±10 %	
1800	40.0 ±10 %		1.40 ±10 %	
1900	40.0 ±10 %		1.40 ±10 %	
1950	40.0 ±10 %		1.40 ±10 %	
2000	40.0 ±10 %		1.40 ±10 %	



SAR REFERENCE DIPOLE CALIBRATION REPORT

Ref. ACR.60.11.21.MVGB.A

2100	39.8 ±10 %		1.49 ±10 %	
2300	39.5 ±10 %	42.2	1.67 ±10 %	1.75
2450	39.2 ±10 %		1.80 ±10 %	
2600	39.0 ±10 %		1.96 ±10 %	
3000	38.5 ±10 %		2.40 ±10 %	
3500	37.9 ±10 %		2.91 ±10 %	

7.3 MEASUREMENT RESULT

The IEEE Std. 1528 and CEI/IEC 62209 standards state that the system validation measurements should produce the SAR values shown below (for phantom thickness of 2 mm), within the uncertainty for the system validation. All SAR values are normalized to 1 W forward power. In bracket, the measured SAR is given with the used input power.

Frequency MHz	1 g SAR (W/kg/W)		10 g SAR (W/kg/W)	
	required	measured	required	measured
300	2.85		1.94	
450	4.58		3.06	
750	8.49		5.55	
835	9.56		6.22	
900	10.9		6.99	
1450	29		16	
1500	30.5		16.8	
1640	34.2		18.4	
1750	36.4		19.3	
1800	38.4		20.1	
1900	39.7		20.5	
1950	40.5		20.9	
2000	41.1		21.1	
2100	43.6		21.9	
2300	48.7	50.65 (5.07)	23.3	23.55 (2.36)
2450	52.4		24	
2600	55.3		24.6	
3000	63.8		25.7	
3500	67.1		25	



SAR REFERENCE DIPOLE CALIBRATION REPORT

Ref: ACR.60.11.21.MVGB.A

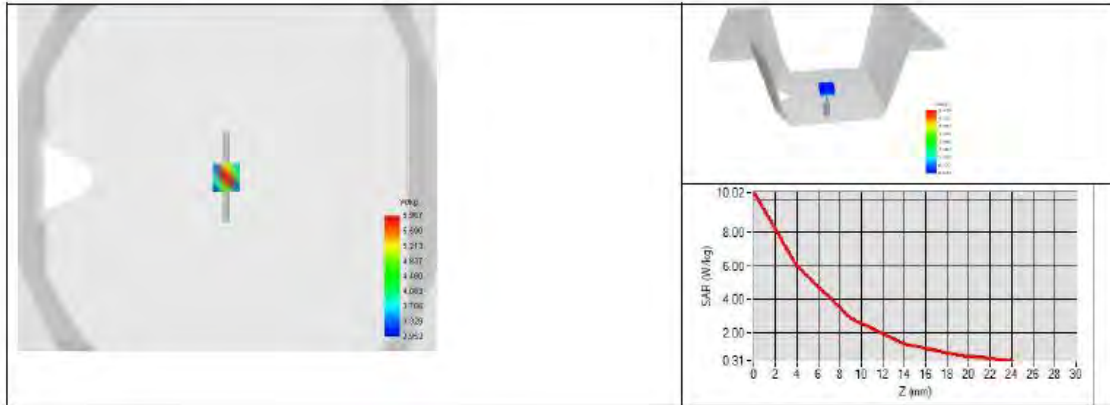



SAR REFERENCE DIPOLE CALIBRATION REPORT

Ref. ACR.60.11.21.MVGB.A

8 LIST OF EQUIPMENT

Equipment Summary Sheet				
Equipment Description	Manufacturer / Model	Identification No.	Current Calibration Date	Next Calibration Date
SAM Phantom	MVG	SN-13/09-SAM68	Validated. No cal required.	Validated. No cal required.
COMOSAR Test Bench	Version 3	NA	Validated. No cal required.	Validated. No cal required.
Network Analyzer	Rohde & Schwarz ZVM	100203	05/2019	05/2022
Network Analyzer – Calibration kit	Rohde & Schwarz ZV-Z235	101223	05/2019	05/2022
Calipers	Mitutoyo	SN 0009732	10/2019	10/2022
Reference Probe	MVG	EPGO333 SN 41/18	05/2020	05/2021
Multimeter	Keithley 2000	1160271	02/2020	02/2023
Signal Generator	Rohde & Schwarz SMB	106589	04/2019	04/2022
Amplifier	Aethercomm	SN 046	Characterized prior to test. No cal required.	Characterized prior to test. No cal required.
Power Meter	NI-USB 5680	170100013	05/2019	05/2022
Directional Coupler	Narda 4216-20	01386	Characterized prior to test. No cal required.	Characterized prior to test. No cal required.
Temperature / Humidity Sensor	Testo 184 H1	44220687	05/2020	05/2023



SAR Reference Dipole Calibration Report

Ref : ACR.60.8.21.MVGB.A

SHENZHEN NTEK TESTING TECHNOLOGY CO., LTD.

BUILDING E, FENDA SCIENCE PARK, SANWEI
COMMUNITY, XIXIANG STREET,
BAO'AN DISTRICT, SHENZHEN GUANGDONG, CHINA
MVG COMOSAR REFERENCE DIPOLE

FREQUENCY: 2450 MHZ

SERIAL NO.: SN 03/15 DIP2G450-352

Calibrated at MVG

Z.I. de la pointe du diable

Technopôle Brest Iroise – 295 avenue Alexis de Rochon

29280 PLOUZANE - FRANCE

Calibration date: 03/01/2021



Accreditations #2-6789 and #2-6814
Scope available on www.cofrac.fr

Summary:

This document presents the method and results from an accredited SAR reference dipole calibration performed at MVG, using the COMOSAR test bench. The test results covered by accreditation are traceable to the International System of Units (SI).



SAR REFERENCE DIPOLE CALIBRATION REPORT

Ref: ACR.60.8.21.MVGB.A

	Name	Function	Date	Signature
Prepared by :	Jérôme LUC	Technical Manager	3/1/2021	<i>JLS</i>
Checked by :	Jérôme LUC	Technical Manager	3/1/2021	<i>JLS</i>
Approved by :	Yann Toutain	Laboratory Director	3/1/2021	<i>Yann Toutain</i>

2021.03.01
 13:13:40
 +01'00'

	Customer Name
Distribution :	SHENZHEN NTEK TESTING TECHNOLOGY CO., LTD.

Issue	Name	Date	Modifications
A	Jérôme LE GALL	3/1/2021	Initial release



SAR REFERENCE DIPOLE CALIBRATION REPORT

Ref. ACR.60.8.21.MVGB.A

TABLE OF CONTENTS

1	Introduction.....	4
2	Device Under Test	4
3	Product Description	4
3.1	General Information	4
4	Measurement Method	5
4.1	Return Loss Requirements	5
4.2	Mechanical Requirements	5
5	Measurement Uncertainty.....	5
5.1	Return Loss	5
5.2	Dimension Measurement	5
5.3	Validation Measurement	5
6	Calibration Measurement Results.....	6
6.1	Return Loss and Impedance	6
6.2	Mechanical Dimensions	6
7	Validation measurement	7
7.1	Measurement Condition	7
7.2	Head Liquid Measurement	7
7.3	Measurement Result	8
8	List of Equipment	10



SAR REFERENCE DIPOLE CALIBRATION REPORT

Ref: ACR.60.8.21.MVGB.A

1 INTRODUCTION

This document contains a summary of the requirements set forth by the IEEE 1528, FCC KDBs and CEI/IEC 62209 standards for reference dipoles used for SAR measurement system validations and the measurements that were performed to verify that the product complies with the fore mentioned standards.

2 DEVICE UNDER TEST

Device Under Test	
Device Type	COMOSAR 2450 MHz REFERENCE DIPOLE
Manufacturer	MVG
Model	SID2450
Serial Number	SN 03/15 DIP2G450-352
Product Condition (new / used)	Used

3 PRODUCT DESCRIPTION

3.1 GENERAL INFORMATION

MVG’s COMOSAR Validation Dipoles are built in accordance to the IEEE 1528, FCC KDBs and CEI/IEC 62209 standards. The product is designed for use with the COMOSAR test bench only.



Figure 1 – MVG COMOSAR Validation Dipole



SAR REFERENCE DIPOLE CALIBRATION REPORT

Ref: ACR.60.8.21.MVGB.A

4 MEASUREMENT METHOD

The IEEE 1528, FCC KDBs and CEI/IEC 62209 standards provide requirements for reference dipoles used for system validation measurements. The following measurements were performed to verify that the product complies with the fore mentioned standards.

4.1 RETURN LOSS REQUIREMENTS

The dipole used for SAR system validation measurements and checks must have a return loss of -20 dB or better. The return loss measurement shall be performed against a liquid filled phantom, with the phantom constructed as outlined in the fore mentioned standards. A direct method is used with a network analyser and its calibration kit, both with a valid ISO17025 calibration.

4.2 MECHANICAL REQUIREMENTS

The IEEE Std. 1528 and CEI/IEC 62209 standards specify the mechanical components and dimensions of the validation dipoles, with the dimension's frequency and phantom shell thickness dependent. The COMOSAR test bench employs a 2 mm phantom shell thickness therefore the dipoles sold for use with the COMOSAR test bench comply with the requirements set forth for a 2 mm phantom shell thickness. A direct method is used with a ISO17025 calibrated caliper.

5 MEASUREMENT UNCERTAINTY

All uncertainties listed below represent an expanded uncertainty expressed at approximately the 95% confidence level using a coverage factor of k=2, traceable to the Internationally Accepted Guides to Measurement Uncertainty.

5.1 RETURN LOSS

The following uncertainties apply to the return loss measurement:

Frequency band	Expanded Uncertainty on Return Loss
400-6000MHz	0.08 LIN

5.2 DIMENSION MEASUREMENT

The following uncertainties apply to the dimension measurements:

Length (mm)	Expanded Uncertainty on Length
0 - 300	0.20 mm
300 - 450	0.44 mm

5.3 VALIDATION MEASUREMENT

The guidelines outlined in the IEEE 1528, FCC KDBs, CENELEC EN50361 and CEI/IEC 62209 standards were followed to generate the measurement uncertainty for validation measurements.

Scan Volume	Expanded Uncertainty



SAR REFERENCE DIPOLE CALIBRATION REPORT

Ref: ACR.60.8.21.MVGB.A

1 g	19 % (SAR)
10 g	19 % (SAR)

6 CALIBRATION MEASUREMENT RESULTS

6.1 RETURN LOSS AND IMPEDANCE

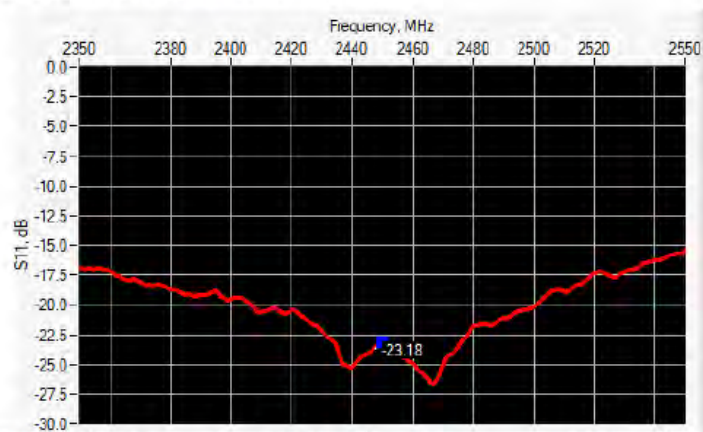

Frequency (MHz)	Return Loss (dB)	Requirement (dB)	Impedance
2450	-23.18	-20	56.3 Ω - 2.9 jΩ

6.2 MECHANICAL DIMENSIONS

Frequency MHz	L mm		h mm		d mm	
	required	measured	required	measured	required	measured
300	420.0 ±1 %.		250.0 ±1 %.		6.35 ±1 %.	
450	290.0 ±1 %.		166.7 ±1 %.		6.35 ±1 %.	
750	176.0 ±1 %.		100.0 ±1 %.		6.35 ±1 %.	
835	161.0 ±1 %.		89.8 ±1 %.		3.6 ±1 %.	
900	149.0 ±1 %.		83.3 ±1 %.		3.6 ±1 %.	
1450	89.1 ±1 %.		51.7 ±1 %.		3.6 ±1 %.	
1500	80.5 ±1 %.		50.0 ±1 %.		3.6 ±1 %.	
1640	79.0 ±1 %.		45.7 ±1 %.		3.6 ±1 %.	
1750	75.2 ±1 %.		42.9 ±1 %.		3.6 ±1 %.	
1800	72.0 ±1 %.		41.7 ±1 %.		3.6 ±1 %.	
1900	68.0 ±1 %.		39.5 ±1 %.		3.6 ±1 %.	
1950	66.3 ±1 %.		38.5 ±1 %.		3.6 ±1 %.	
2000	64.5 ±1 %.		37.5 ±1 %.		3.6 ±1 %.	
2100	61.0 ±1 %.		35.7 ±1 %.		3.6 ±1 %.	
2300	55.5 ±1 %.		32.6 ±1 %.		3.6 ±1 %.	
2450	51.5 ±1 %.	-	30.4 ±1 %.	-	3.6 ±1 %.	-



SAR REFERENCE DIPOLE CALIBRATION REPORT

Ref. ACR.60.8.21.MVGB.A

2600	48.5 ±1 %.		28.8 ±1 %.		3.6 ±1 %.	
3000	41.5 ±1 %.		25.0 ±1 %.		3.6 ±1 %.	
3500	37.0±1 %.		26.4 ±1 %.		3.6 ±1 %.	
3700	34.7±1 %.		26.4 ±1 %.		3.6 ±1 %.	

7 VALIDATION MEASUREMENT

The IEEE Std. 1528, FCC KDBs and CEI/IEC 62209 standards state that the system validation measurements must be performed using a reference dipole meeting the fore mentioned return loss and mechanical dimension requirements. The validation measurement must be performed against a liquid filled flat phantom, with the phantom constructed as outlined in the fore mentioned standards. Per the standards, the dipole shall be positioned below the bottom of the phantom, with the dipole length centered and parallel to the longest dimension of the flat phantom, with the top surface of the dipole at the described distance from the bottom surface of the phantom.

7.1 MEASUREMENT CONDITION

Software	OPENSAR V5
Phantom	SN 13/09 SAM68
Probe	SN 41/18 EPGO333
Liquid	Head Liquid Values: eps' : 41.9 sigma : 1.88
Distance between dipole center and liquid	10.0 mm
Area scan resolution	dx=8mm/dy=8mm
Zoon Scan Resolution	dx=5mm/dy=5mm/dz=5mm
Frequency	24502450 MHz
Input power	20 dBm
Liquid Temperature	20 +/- 1 °C
Lab Temperature	20 +/- 1 °C
Lab Humidity	30-70 %

7.2 HEAD LIQUID MEASUREMENT

Frequency MHz	Relative permittivity (ε _r)		Conductivity (σ) S/m	
	required	measured	required	measured
300	45.3 ±10 %		0.87 ±10 %	
450	43.5 ±10 %		0.87 ±10 %	
750	41.9 ±10 %		0.89 ±10 %	
835	41.5 ±10 %		0.90 ±10 %	
900	41.5 ±10 %		0.97 ±10 %	
1450	40.5 ±10 %		1.20 ±10 %	
1500	40.4 ±10 %		1.23 ±10 %	
1640	40.2 ±10 %		1.31 ±10 %	
1750	40.1 ±10 %		1.37 ±10 %	
1800	40.0 ±10 %		1.40 ±10 %	
1900	40.0 ±10 %		1.40 ±10 %	
1950	40.0 ±10 %		1.40 ±10 %	
2000	40.0 ±10 %		1.40 ±10 %	



SAR REFERENCE DIPOLE CALIBRATION REPORT

Ref. ACR.60.8.21.MVGB.A

2100	39.8 ±10 %		1.49 ±10 %	
2300	39.5 ±10 %		1.67 ±10 %	
2450	39.2 ±10 %	41.9	1.80 ±10 %	1.88
2600	39.0 ±10 %		1.96 ±10 %	
3000	38.5 ±10 %		2.40 ±10 %	
3500	37.9 ±10 %		2.91 ±10 %	

7.3 MEASUREMENT RESULT

The IEEE Std. 1528 and CEI/IEC 62209 standards state that the system validation measurements should produce the SAR values shown below (for phantom thickness of 2 mm), within the uncertainty for the system validation. All SAR values are normalized to 1 W forward power. In bracket, the measured SAR is given with the used input power.

Frequency MHz	1 g SAR (W/kg/W)		10 g SAR (W/kg/W)	
	required	measured	required	measured
300	2.85		1.94	
450	4.58		3.06	
750	8.49		5.55	
835	9.56		6.22	
900	10.9		6.99	
1450	29		16	
1500	30.5		16.8	
1640	34.2		18.4	
1750	36.4		19.3	
1800	38.4		20.1	
1900	39.7		20.5	
1950	40.5		20.9	
2000	41.1		21.1	
2100	43.6		21.9	
2300	48.7		23.3	
2450	52.4	53.69 (5.37)	24	23.94 (2.39)
2600	55.3		24.6	
3000	63.8		25.7	
3500	67.1		25	



SAR REFERENCE DIPOLE CALIBRATION REPORT

Ref. ACR.60.8.21.MVGB.A

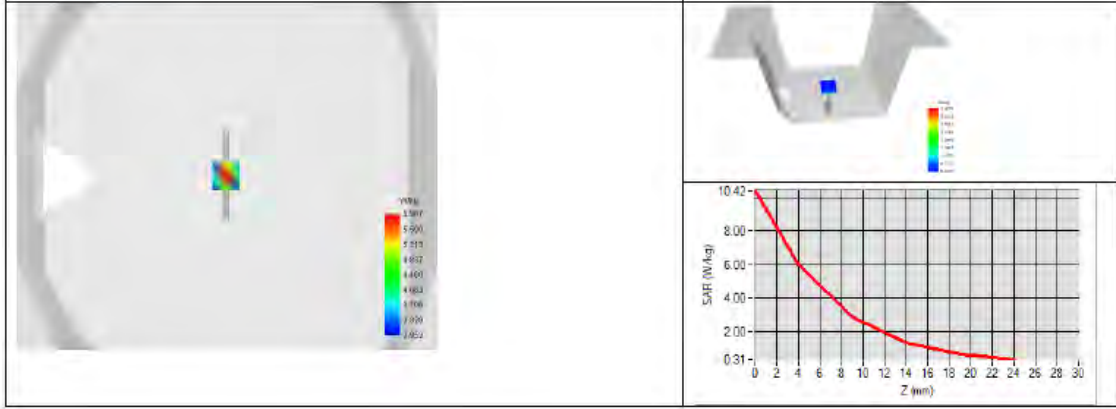



SAR REFERENCE DIPOLE CALIBRATION REPORT

Ref: ACR.60.8.21.MVGB.A

8 LIST OF EQUIPMENT

Equipment Summary Sheet				
Equipment Description	Manufacturer / Model	Identification No.	Current Calibration Date	Next Calibration Date
SAM Phantom	MVG	SN-13/09-SAM68	Validated. No cal required.	Validated. No cal required.
COMOSAR Test Bench	Version 3	NA	Validated. No cal required.	Validated. No cal required.
Network Analyzer	Rohde & Schwarz ZVM	100203	05/2019	05/2022
Network Analyzer – Calibration kit	Rohde & Schwarz ZV-Z235	101223	05/2019	05/2022
Calipers	Mitutoyo	SN 0009732	10/2019	10/2022
Reference Probe	MVG	EPGO333 SN 41/18	05/2020	05/2021
Multimeter	Keithley 2000	1160271	02/2020	02/2023
Signal Generator	Rohde & Schwarz SMB	106589	04/2019	04/2022
Amplifier	Aethercomm	SN 046	Characterized prior to test. No cal required.	Characterized prior to test. No cal required.
Power Meter	NI-USB 5680	170100013	05/2019	05/2022
Directional Coupler	Narda 4216-20	01386	Characterized prior to test. No cal required.	Characterized prior to test. No cal required.
Temperature / Humidity Sensor	Testo 184 H1	44220687	05/2020	05/2023



SAR Reference Dipole Calibration Report

Ref : ACR.60.9.21.MVGB.A

SHENZHEN NTEK TESTING TECHNOLOGY CO., LTD.

BUILDING E, FENDA SCIENCE PARK, SANWEI
COMMUNITY, XIXIANG STREET,
BAO'AN DISTRICT, SHENZHEN GUANGDONG, CHINA
MVG COMOSAR REFERENCE DIPOLE

FREQUENCY: 2600 MHZ

SERIAL NO.: SN 03/15 DIP2G600-356

Calibrated at MVG

Z.I. de la pointe du diable

Technopôle Brest Iroise – 295 avenue Alexis de Rochon
29280 PLOUZANE - FRANCE

Calibration date: 03/01/2021



Accreditations #2-6789 and #2-6814
Scope available on www.cofrac.fr

Summary:

This document presents the method and results from an accredited SAR reference dipole calibration performed at MVG, using the COMOSAR test bench. The test results covered by accreditation are traceable to the International System of Units (SI).



SAR REFERENCE DIPOLE CALIBRATION REPORT

Ref. ACR.60.9.21.MVGB.A

	Name	Function	Date	Signature
Prepared by :	Jérôme Luc	Technical Manager	3/1/2021	<i>JL</i>
Checked by :	Jérôme Luc	Technical Manager	3/1/2021	<i>JL</i>
Approved by :	Yann Toutain	Laboratory Director	3/1/2021	<i>Yann Toutain</i>

2021.03.01
13:14:51
+01'00'

	Customer Name
Distribution :	SHENZHEN NTEK TESTING TECHNOLOGY CO., LTD.

Issue	Name	Date	Modifications
A	Jérôme Luc	3/1/2021	Initial release



SAR REFERENCE DIPOLE CALIBRATION REPORT

Ref. ACR.60.9.21.MVGB.A

TABLE OF CONTENTS

1	Introduction.....	4
2	Device Under Test	4
3	Product Description	4
3.1	General Information	4
4	Measurement Method	5
4.1	Return Loss Requirements	5
4.2	Mechanical Requirements	5
5	Measurement Uncertainty.....	5
5.1	Return Loss	5
5.2	Dimension Measurement	5
5.3	Validation Measurement	5
6	Calibration Measurement Results.....	6
6.1	Return Loss and Impedance	6
6.2	Mechanical Dimensions	6
7	Validation measurement	7
7.1	Measurement Condition	7
7.2	Head Liquid Measurement	7
7.3	Measurement Result	8
8	List of Equipment	10



SAR REFERENCE DIPOLE CALIBRATION REPORT

Ref: ACR.60.9.21.MVGB.A

1 INTRODUCTION

This document contains a summary of the requirements set forth by the IEEE 1528, FCC KDBs and CEI/IEC 62209 standards for reference dipoles used for SAR measurement system validations and the measurements that were performed to verify that the product complies with the fore mentioned standards.

2 DEVICE UNDER TEST

Device Under Test	
Device Type	COMOSAR 2600 MHz REFERENCE DIPOLE
Manufacturer	MVG
Model	SID2600
Serial Number	SN 03/15 DIP2G600-356
Product Condition (new / used)	Used

3 PRODUCT DESCRIPTION

3.1 GENERAL INFORMATION

MVG’s COMOSAR Validation Dipoles are built in accordance to the IEEE 1528, FCC KDBs and CEI/IEC 62209 standards. The product is designed for use with the COMOSAR test bench only.



Figure 1 – MVG COMOSAR Validation Dipole



SAR REFERENCE DIPOLE CALIBRATION REPORT

Ref. ACR.60.9.21.MVGB.A

4 MEASUREMENT METHOD

The IEEE 1528, FCC KDBs and CEI/IEC 62209 standards provide requirements for reference dipoles used for system validation measurements. The following measurements were performed to verify that the product complies with the fore mentioned standards.

4.1 RETURN LOSS REQUIREMENTS

The dipole used for SAR system validation measurements and checks must have a return loss of -20 dB or better. The return loss measurement shall be performed against a liquid filled flat phantom, with the phantom constructed as outlined in the fore mentioned standards. A direct method is used with a network analyser and its calibration kit, both with a valid ISO17025 calibration.

4.2 MECHANICAL REQUIREMENTS

The IEEE Std. 1528 and CEI/IEC 62209 standards specify the mechanical components and dimensions of the validation dipoles, with the dimension's frequency and phantom shell thickness dependent. The COMOSAR test bench employs a 2 mm phantom shell thickness therefore the dipoles sold for use with the COMOSAR test bench comply with the requirements set forth for a 2 mm phantom shell thickness. A direct method is used with a ISO17025 calibrated caliper.

5 MEASUREMENT UNCERTAINTY

All uncertainties listed below represent an expanded uncertainty expressed at approximately the 95% confidence level using a coverage factor of k=2, traceable to the Internationally Accepted Guides to Measurement Uncertainty.

5.1 RETURN LOSS

The following uncertainties apply to the return loss measurement:

Frequency band	Expanded Uncertainty on Return Loss
400-6000MHz	0.08 LIN

5.2 DIMENSION MEASUREMENT

The following uncertainties apply to the dimension measurements:

Length (mm)	Expanded Uncertainty on Length
0 - 300	0.20 mm
300 - 450	0.44 mm

5.3 VALIDATION MEASUREMENT

The guidelines outlined in the IEEE 1528, FCC KDBs, CENELEC EN50361 and CEI/IEC 62209 standards were followed to generate the measurement uncertainty for validation measurements.

Scan Volume	Expanded Uncertainty



SAR REFERENCE DIPOLE CALIBRATION REPORT

Ref: ACR.60.9.21.MVGB.A

1 g	19 % (SAR)
10 g	19 % (SAR)

6 CALIBRATION MEASUREMENT RESULTS

6.1 RETURN LOSS AND IMPEDANCE

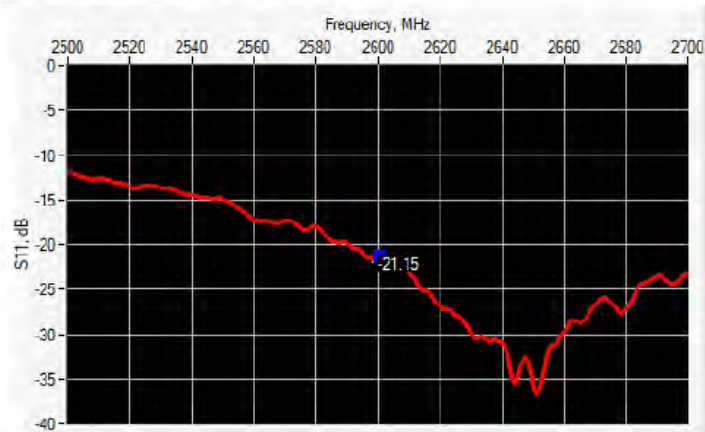

Frequency (MHz)	Return Loss (dB)	Requirement (dB)	Impedance
2600	-21.15	-20	52.7 Ω - 8.3 jΩ

6.2 MECHANICAL DIMENSIONS

Frequency MHz	L mm		h mm		d mm	
	required	measured	required	measured	required	measured
300	420.0 ±1 %.		250.0 ±1 %.		6.35 ±1 %.	
450	290.0 ±1 %.		166.7 ±1 %.		6.35 ±1 %.	
750	176.0 ±1 %.		100.0 ±1 %.		6.35 ±1 %.	
835	161.0 ±1 %.		89.8 ±1 %.		3.6 ±1 %.	
900	149.0 ±1 %.		83.3 ±1 %.		3.6 ±1 %.	
1450	89.1 ±1 %.		51.7 ±1 %.		3.6 ±1 %.	
1500	80.5 ±1 %.		50.0 ±1 %.		3.6 ±1 %.	
1640	79.0 ±1 %.		45.7 ±1 %.		3.6 ±1 %.	
1750	75.2 ±1 %.		42.9 ±1 %.		3.6 ±1 %.	
1800	72.0 ±1 %.		41.7 ±1 %.		3.6 ±1 %.	
1900	68.0 ±1 %.		39.5 ±1 %.		3.6 ±1 %.	
1950	66.3 ±1 %.		38.5 ±1 %.		3.6 ±1 %.	
2000	64.5 ±1 %.		37.5 ±1 %.		3.6 ±1 %.	
2100	61.0 ±1 %.		35.7 ±1 %.		3.6 ±1 %.	
2300	55.5 ±1 %.		32.6 ±1 %.		3.6 ±1 %.	
2450	51.5 ±1 %.		30.4 ±1 %.		3.6 ±1 %.	



SAR REFERENCE DIPOLE CALIBRATION REPORT

Ref: ACR.60.9.21.MVGB.A

2600	48.5 ±1 %.	-	28.8 ±1 %.	-	3.6 ±1 %.	-
3000	41.5 ±1 %.		25.0 ±1 %.		3.6 ±1 %.	
3500	37.0±1 %.		26.4 ±1 %.		3.6 ±1 %.	
3700	34.7±1 %.		26.4 ±1 %.		3.6 ±1 %.	

7 VALIDATION MEASUREMENT

The IEEE Std. 1528, FCC KDBs and CEI/IEC 62209 standards state that the system validation measurements must be performed using a reference dipole meeting the fore mentioned return loss and mechanical dimension requirements. The validation measurement must be performed against a liquid filled flat phantom, with the phantom constructed as outlined in the fore mentioned standards. Per the standards, the dipole shall be positioned below the bottom of the phantom, with the dipole length centered and parallel to the longest dimension of the flat phantom, with the top surface of the dipole at the described distance from the bottom surface of the phantom.

7.1 MEASUREMENT CONDITION

Software	OPENSAR V5
Phantom	SN 13/09 SAM68
Probe	SN 41/18 EPGO333
Liquid	Head Liquid Values: ϵ_p' : 41.5 σ : 2.03
Distance between dipole center and liquid	10.0 mm
Area scan resolution	dx=8mm/dy=8mm
Zoon Scan Resolution	dx=5mm/dy=5mm/dz=5mm
Frequency	26002600 MHz
Input power	20 dBm
Liquid Temperature	20 +/- 1 °C
Lab Temperature	20 +/- 1 °C
Lab Humidity	30-70 %

7.2 HEAD LIQUID MEASUREMENT

Frequency MHz	Relative permittivity (ϵ_r')		Conductivity (σ) S/m	
	required	measured	required	measured
300	45.3 ±10 %		0.87 ±10 %	
450	43.5 ±10 %		0.87 ±10 %	
750	41.9 ±10 %		0.89 ±10 %	
835	41.5 ±10 %		0.90 ±10 %	
900	41.5 ±10 %		0.97 ±10 %	
1450	40.5 ±10 %		1.20 ±10 %	
1500	40.4 ±10 %		1.23 ±10 %	
1640	40.2 ±10 %		1.31 ±10 %	
1750	40.1 ±10 %		1.37 ±10 %	
1800	40.0 ±10 %		1.40 ±10 %	
1900	40.0 ±10 %		1.40 ±10 %	
1950	40.0 ±10 %		1.40 ±10 %	
2000	40.0 ±10 %		1.40 ±10 %	



SAR REFERENCE DIPOLE CALIBRATION REPORT

Ref. ACR.60.9.21.MVGB.A

2100	39.8 ±10 %		1.49 ±10 %	
2300	39.5 ±10 %		1.67 ±10 %	
2450	39.2 ±10 %		1.80 ±10 %	
2600	39.0 ±10 %	41.5	1.96 ±10 %	2.03
3000	38.5 ±10 %		2.40 ±10 %	
3500	37.9 ±10 %		2.91 ±10 %	

7.3 MEASUREMENT RESULT

The IEEE Std. 1528 and CEI/IEC 62209 standards state that the system validation measurements should produce the SAR values shown below (for phantom thickness of 2 mm), within the uncertainty for the system validation. All SAR values are normalized to 1 W forward power. In bracket, the measured SAR is given with the used input power.

Frequency MHz	1 g SAR (W/kg/W)		10 g SAR (W/kg/W)	
	required	measured	required	measured
300	2.85		1.94	
450	4.58		3.06	
750	8.49		5.55	
835	9.56		6.22	
900	10.9		6.99	
1450	29		16	
1500	30.5		16.8	
1640	34.2		18.4	
1750	36.4		19.3	
1800	38.4		20.1	
1900	39.7		20.5	
1950	40.5		20.9	
2000	41.1		21.1	
2100	43.6		21.9	
2300	48.7		23.3	
2450	52.4		24	
2600	55.3	55.83 (5.58)	24.6	24.19 (2.42)
3000	63.8		25.7	
3500	67.1		25	



SAR REFERENCE DIPOLE CALIBRATION REPORT

Ref: ACR.60.9.21.MVGB.A

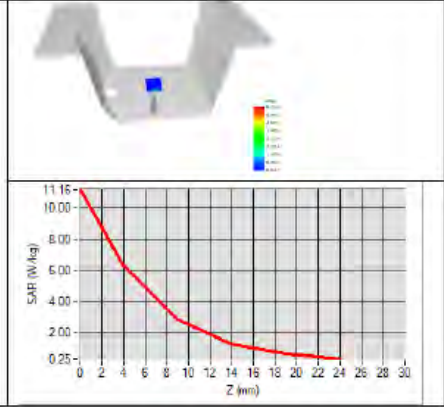
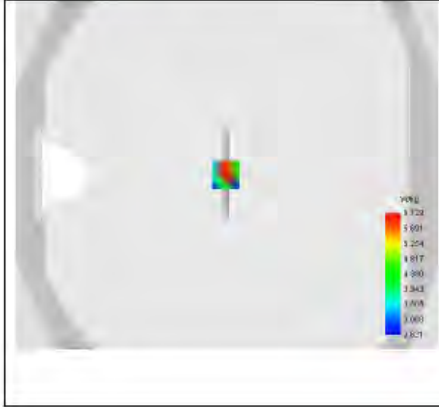



SAR REFERENCE DIPOLE CALIBRATION REPORT

Ref: ACR.60.9.21.MVGB.A

8 LIST OF EQUIPMENT

Equipment Summary Sheet				
Equipment Description	Manufacturer / Model	Identification No.	Current Calibration Date	Next Calibration Date
SAM Phantom	MVG	SN-13/09-SAM68	Validated. No cal required.	Validated. No cal required.
COMOSAR Test Bench	Version 3	NA	Validated. No cal required.	Validated. No cal required.
Network Analyzer	Rohde & Schwarz ZVM	100203	05/2019	05/2022
Network Analyzer – Calibration kit	Rohde & Schwarz ZV-Z235	101223	05/2019	05/2022
Calipers	Mitutoyo	SN 0009732	10/2019	10/2022
Reference Probe	MVG	EPGO333 SN 41/18	05/2020	05/2021
Multimeter	Keithley 2000	1160271	02/2020	02/2023
Signal Generator	Rohde & Schwarz SMB	106589	04/2019	04/2022
Amplifier	Aethercomm	SN 046	Characterized prior to test. No cal required.	Characterized prior to test. No cal required.
Power Meter	NI-USB 5680	170100013	05/2019	05/2022
Directional Coupler	Narda 4216-20	01386	Characterized prior to test. No cal required.	Characterized prior to test. No cal required.
Temperature / Humidity Sensor	Testo 184 H1	44220687	05/2020	05/2023