

---

# RF Test Report

---

Report No.: AGC14435230901ER03

**PRODUCT DESIGNATION** : Smart Watch

**BRAND NAME** : Blackview, IOWODO, FeipuQu, Baolubao

**MODEL NAME** : X1\_5, X1, X1Pro, W30, W50, W60, W70, W80, W90, W30Pro, W50Pro, W60Pro, W70Pro, W80Pro, W90Pro

**APPLICANT** : Shenzhen Hairuichuang Technology Co., Ltd.

**DATE OF ISSUE** : Sep. 21, 2023

**STANDARD(S)** : ETSI EN 300 328 V2.2.2 (2019-07)

**REPORT VERSION** : V1.0

Attestation of Global Compliance (Shenzhen) Co., Ltd



Any report having not been signed by authorized approver, or having been altered without authorization, or having not been stamped by the "Dedicated Testing/Inspection Stamp" is deemed to be invalid. Copying or excerpting portion of, or altering the content of the report is not permitted without the written authorization of AGC. The test results presented in the report apply only to the tested sample. Any objections to report issued by AGC should be submitted to AGC within 15days after the issuance of the test report. Further enquiry of validity or verification of the test report should be addressed to AGC by [agc01@agccert.com](mailto:agc01@agccert.com).

Attestation of Global Compliance(Shenzhen)Co., Ltd  
Attestation of Global Compliance(Shenzhen)Std & Tech Co., Ltd  
Tel: +86-755 2523 4088 E-mail: [agc@agccert.com](mailto:agc@agccert.com) Web: <http://www.agccert.com/>



**REPORT REVISE RECORD**

Report Version	Revise Time	Issued Date	Valid Version	Notes
V1.0	/	Sep. 21, 2023	Valid	Initial release

Any report having not been signed by authorized approver, or having been altered without authorization, or having not been stamped by the "Dedicated Testing/Inspection Stamp" is deemed to be invalid. Copying or excerpting portion of, or altering the content of the report is not permitted without the written authorization of AGC. The test results presented in the report apply only to the tested sample. Any objections to report issued by AGC should be submitted to AGC within 15days after the issuance of the test report. Further enquiry of validity or verification of the test report should be addressed to AGC by [agc01@agccert.com](mailto:agc01@agccert.com).

Attestation of Global Compliance(Shenzhen)Co., Ltd  
Attestation of Global Compliance(Shenzhen)Std & Tech Co., Ltd  
Tel: +86-755 2523 4088 E-mail: [agc@agccert.com](mailto:agc@agccert.com) Web: <http://www.agccert.com/>

## TABLE OF CONTENTS

<b>1. VERIFICATION OF CONFORMITY</b> .....	<b>4</b>
<b>2. GENERAL INFORMATION</b> .....	<b>5</b>
2.1. DESCRIPTION OF EUT.....	5
2.2. SUPPORT EQUIPMENT .....	6
2.3. DESCRIPTION OF TEST MODES.....	6
2.4. OBJECTIVE .....	7
2.5. TEST ITEMS AND THE RESULTS.....	7
2.6. ENVIRONMENTAL CONDITIONS.....	7
<b>3. MEASUREMENT UNCERTAINTY</b> .....	<b>8</b>
<b>4. IDENTIFICATION OF THE RESPONSIBLE TESTING LOCATION</b> .....	<b>9</b>
<b>5. ETSI EN 300 328 REQUIREMENTS</b> .....	<b>10</b>
5.1. RF OUTPUT POWER.....	10
5.2. POWER SPECTRAL DENSITY .....	14
5.3. ADAPTIVITY.....	17
5.4. OCCUPIED CHANNEL BANDWIDTH .....	19
5.5. TRANSMITTER UNWANTED EMISSIONS IN THE OUT-OF-BAND DOMAIN .....	22
5.6. TRANSMITTER UNWANTED EMISSIONS IN THE SPURIOUS DOMAIN .....	28
5.7. RECEIVER UNWANTED EMISSIONS IN THE SPURIOUS DOMAIN .....	42
5.8. RECEIVER BLOCKING .....	53
<b>APPENDIX A: PHOTOGRAPHS OF TEST SETUP</b> .....	<b>57</b>
<b>APPENDIX B: PHOTOGRAPHS OF EUT</b> .....	<b>59</b>

Any report having not been signed by authorized approver, or having been altered without authorization, or having not been stamped by the “Dedicated Testing/Inspection Stamp” is deemed to be invalid. Copying or excerpting portion of, or altering the content of the report is not permitted without the written authorization of AGC. The test results presented in the report apply only to the tested sample. Any objections to report issued by AGC should be submitted to AGC within 15days after the issuance of the test report. Further enquiry of validity or verification of the test report should be addressed to AGC by [agc01@agccert.com](mailto:agc01@agccert.com).

### 1. VERIFICATION OF CONFORMITY

<b>Applicant</b>	Shenzhen Hairuichuang Technology Co., Ltd.
<b>Address</b>	Room 2001, Building A, Weidonglong Business Building, No. 2125, Meilong Avenue, Longhua District, Shenzhen, China
<b>Manufacturer</b>	Shenzhen Hairuichuang Technology Co., Ltd.
<b>Address</b>	Room 2001, Building A, Weidonglong Business Building, No. 2125, Meilong Avenue, Longhua District, Shenzhen, China
<b>Factory</b>	Shenzhen Hairuichuang Technology Co., Ltd.
<b>Address</b>	Room 2001, Building A, Weidonglong Business Building, No. 2125, Meilong Avenue, Longhua District, Shenzhen, China
<b>Product Designation</b>	Smart Watch
<b>Brand Name</b>	Blackview, IOWODO, FeipuQu, Baolubao
<b>Test Model</b>	X1_5
<b>Series Model</b>	X1, X1Pro, W30, W50, W60, W70, W80, W90, W30Pro, W50Pro, W60Pro, W70Pro, W80Pro, W90Pro
<b>Difference Description</b>	All the same except for the model names.
<b>Date of receipt of test item</b>	Sep. 11, 2023
<b>Date of test</b>	Sep. 11, 2023 to Sep. 21, 2023
<b>Deviation</b>	None
<b>Condition of Test Sample</b>	Normal
<b>Test Result</b>	Pass
<b>Report Template</b>	AGCRT-EC-BLE/RF

Note: The test results of this report relate only to the tested sample identified in this report.

Prepared By



Cici Li  
(Project Engineer)

Sep. 21, 2023

Reviewed By



Calvin Liu  
(Reviewer)

Sep. 21, 2023

Approved By



Max Zhang  
Authorized Officer

Sep. 21, 2023

Any report having not been signed by authorized approver, or having been altered without authorization, or having not been stamped by the “Dedicated Testing/Inspection Stamp” is deemed to be invalid. Copying or excerpting portion of, or altering the content of the report is not permitted without the written authorization of AGC. The test results presented in the report apply only to the tested sample. Any objections to report issued by AGC should be submitted to AGC within 15days after the issuance of the test report. Further enquiry of validity or verification of the test report should be addressed to AGC by agc01@agccert.com.

## 2. GENERAL INFORMATION

### 2.1. DESCRIPTION OF EUT

<b>Operating Frequency (BLE)</b>	2402MHz-2480MHz
<b>Support Channels (BLE)</b>	40 Channels
<b>Modulation (BLE)</b>	GFSK
<b>Bluetooth Version</b>	V5.3
<b>Hardware Version</b>	V1.0
<b>Software Version</b>	V1.0
<b>The type of the equipment</b>	non-FHSS adaptive equipment with only one antenna
<b>The maximum RF Output Power</b>	BLE 1Mbps: 1.39dBm BLE 1Mbps: 1.12dBm
<b>Nominal Channel Bandwidth</b>	<input checked="" type="checkbox"/> 1MHz <input checked="" type="checkbox"/> 2MHz
<b>Antenna designation</b>	FPC Antenna
<b>Antenna Gain</b>	1.29dBi
<b>Power Supply</b>	DC 3.8V by battery or DC 5V by adapter
<b>The extreme operating conditions</b>	Lowest temperature range (LT): -10°C Normal temperature range (NT): 25°C Highest temperature range (HT): 40°C
<b>Geo-location capability</b>	<input type="checkbox"/> Yes <input checked="" type="checkbox"/> No

**Note:**

1. The above information was declared by the manufacturer.
2. The equipment submitted are representative production models.
3. The EUT cannot operated unmodulated.
4. The EUT provides Bluetooth wireless interface operating at 2.4G ISM band (2402MHz-2480MHz).
5. Only the Bluetooth was tested according the standard requirement.
6. The EUT is a stand-alone and portable equipment according to ETSI EN 300 328 V2.2.2.
7. For more details, please refer to the User's manual of the EUT.

Any report having not been signed by authorized approver, or having been altered without authorization, or having not been stamped by the "Dedicated Testing/Inspection Stamp" is deemed to be invalid. Copying or excerpting portion of, or altering the content of the report is not permitted without the written authorization of AGC. The test results presented in the report apply only to the tested sample. Any objections to report issued by AGC should be submitted to AGC within 15days after the issuance of the test report. Further enquiry of validity or verification of the test report should be addressed to AGC by agc01@agccert.com.

## 2.2. SUPPORT EQUIPMENT

Item	Equipment	Mfr/Brand	Model/Type No.	Remark
--	--	--	--	--

## 2.3. DESCRIPTION OF TEST MODES

Test Mode	Description
LE1M_TX_2402_1Mbps	Bluetooth LE Transmitting mode (Channel: 2402, Rate: 1Mbps)
LE1M_TX_2440_1Mbps	Bluetooth LE Transmitting mode (Channel: 2440, Rate: 1Mbps)
LE1M_TX_2480_1Mbps	Bluetooth LE Transmitting mode (Channel: 2480, Rate: 1Mbps)
LE2M_TX_2402_2Mbps	Bluetooth LE Transmitting mode (Channel: 2402, Rate: 2Mbps)
LE2M_TX_2440_2Mbps	Bluetooth LE Transmitting mode (Channel: 2440, Rate: 2Mbps)
LE2M_TX_2480_2Mbps	Bluetooth LE Transmitting mode (Channel: 2480, Rate: 2Mbps)
LE1M_RX_2402_1Mbps	Bluetooth LE Receiving mode (Channel: 2402, Rate: 1Mbps)
LE1M_RX_2480_1Mbps	Bluetooth LE Receiving mode (Channel: 2480, Rate: 1Mbps)
LE2M_RX_2402_2Mbps	Bluetooth LE Receiving mode (Channel: 2402, Rate: 2Mbps)
LE2M_RX_2480_2Mbps	Bluetooth LE Receiving mode (Channel: 2480, Rate: 2Mbps)

Note: All modes have been tested and the worst mode test data recording in the test report, if no any other data.

Any report having not been signed by authorized approver, or having been altered without authorization, or having not been stamped by the "Dedicated Testing/Inspection Stamp" is deemed to be invalid. Copying or excerpting portion of, or altering the content of the report is not permitted without the written authorization of AGC. The test results presented in the report apply only to the tested sample. Any objections to report issued by AGC should be submitted to AGC within 15days after the issuance of the test report. Further enquiry of validity or verification of the test report should be addressed to AGC by agc01@agccert.com.

## 2.4. OBJECTIVE

Perform Radio Spectrum tests for CE Marking according to the provisions of article 3.2 of the Radio Equipment Directive (2014/53/EU) for the BT function of the EUT.

## 2.5. TEST ITEMS AND THE RESULTS

The EUT has been tested according to ETSI EN 300 328 V2.2.2(2019-07).

<b>ETSI EN 300 328 V2.2.2 (2019-07)</b>	Wideband transmission systems; Data transmission equipment operating in the 2,4 GHz band; Harmonised Standard for access to radio spectrum
---	--

Test items and the results are as bellow:

No.	Basic Standard	Test Type	Result
1	ETSI EN 300 328 4.3.2.2	RF Output Power	Pass
2	ETSI EN 300 328 4.3.2.3	Power Spectral Density	Pass
3	ETSI EN 300 328 4.3.2.4	Duty Cycle, Tx-sequence, Tx-gap	N/A
4	ETSI EN 300 328 4.3.2.5	Medium Utilisation (MU) factor	N/A
5	ETSI EN 300 328 4.3.2.6	Adaptivity	N/A
6	ETSI EN 300 328 4.3.2.7	Occupied Channel Bandwidth	Pass
7	ETSI EN 300 328 4.3.2.8	Transmitter unwanted emissions in the out-of-band domain	Pass
8	ETSI EN 300 328 4.3.2.9	Transmitter unwanted emissions in the spurious domain	Pass
9	ETSI EN 300 328 4.3.2.10	Receiver spurious emissions	Pass
10	ETSI EN 300 328 4.3.2.11	Receiver Blocking	Pass

**Note:** 1. N/A- Not Applicable.  
2. The latest versions of basic standards are applied.

## 2.6. ENVIRONMENTAL CONDITIONS

- Temperature: 13-35°C
- Relative Humidity: 30-60 %
- Atmospheric pressure: 86-106 kPa

Any report having not been signed by authorized approver, or having been altered without authorization, or having not been stamped by the "Dedicated Testing/Inspection Stamp" is deemed to be invalid. Copying or excerpting portion of, or altering the content of the report is not permitted without the written authorization of AGC. The test results presented in the report apply only to the tested sample. Any objections to report issued by AGC should be submitted to AGC within 15days after the issuance of the test report. Further enquiry of validity or verification of the test report should be addressed to AGC by agc01@agccert.com.

### 3. MEASUREMENT UNCERTAINTY

The uncertainty is calculated using the methods suggested in the “Guide to the Expression of Uncertainty in Measurement” (GUM) published by ISO.

Item	Measurement Uncertainty
Uncertainty of Radio Frequency	$U_c = \pm 1 \times 10^{-7}$
Uncertainty of total RF power, conducted	$U_c = \pm 0.8 \text{ dB}$
Uncertainty of RF power density, conducted	$U_c = \pm 2.6 \text{ dB}$
Uncertainty of spurious emissions, conducted	$U_c = \pm 2.7 \text{ dB}$
Uncertainty of spurious emissions, radiated	$U_c = \pm 5.4 \text{ dB}$
Uncertainty of Temperature	$U_c = 0.5^\circ \text{C}$
Uncertainty of Humidity	$U_c = \pm 1 \%$
Uncertainty of DC and low frequency voltages	$U_c = \pm 2 \%$

Any report having not been signed by authorized approver, or having been altered without authorization, or having not been stamped by the “Dedicated Testing/Inspection Stamp” is deemed to be invalid. Copying or excerpting portion of, or altering the content of the report is not permitted without the written authorization of AGC. The test results presented in the report apply only to the tested sample. Any objections to report issued by AGC should be submitted to AGC within 15 days after the issuance of the test report. Further enquiry of validity or verification of the test report should be addressed to AGC by [agc01@agccert.com](mailto:agc01@agccert.com).



#### 4. IDENTIFICATION OF THE RESPONSIBLE TESTING LOCATION

<b>Site</b>	Attestation of Global Compliance (Shenzhen) Co., Ltd.
<b>Location</b>	1-2/F, Building 19, Junfeng Industrial Park, Chongqing Road, Heping Community, Fuhai Street, Bao'an District, Shenzhen, Guangdong, China

#### LIST OF EQUIPMENTS USED

Description	Manufacturer	Model No.	S/N	Cal. Date	Cal. Due
MXG X-Series Vector Signal Generator	Agilent	N5182B	MY53050647	Mar. 03, 2023	Mar. 02, 2024
Signal Generator	Agilent	N5171B	MY53050474	Jun. 01, 2023	May 31, 2024
EXA Signal Analyzer	Agilent	N9020A	MY49100060	Jun. 03, 2023	Jun. 02, 2024
USB Wideband Power Sensor	Agilent	U2021XA	MY54110007	May 11, 2021	May 10, 2025
USB Wideband Power Sensor	Agilent	U2021XA	MY54110009	May 11, 2021	May 10, 2025
RF Communication Tester	R&S	CMW270	101933	Jun. 02, 2023	Jun. 01, 2024
Attenuator	Warriors	W13	11324	N/A	N/A
Power splitter	Mini-Circuits	ZFRSC-183-s	3122	N/A	N/A
2.4G Band Fliter	EM Electronics	2400-2500	N/A	Mar. 22, 2022	Mar. 21, 2024
Small environment tester	ESPEC	SH-242	N/A	Aug. 03, 2022	Aug. 02, 2024
AMPLIFIER	ETS-LINDGREN	3117PA	00225134	Sep. 02, 2022	Sep. 01, 2024
ANTENNA	SCHWARZBECK	VULB9168	494	Jan. 05, 2023	Jan. 04, 2025
Biconilog Antenna	ETS-LINDGREN	3142C	00060447	N/A	N/A
HORN ANTENNA	ETS-LINDGREN	3117	00154520	Mar. 23, 2023	Mar. 22, 2024
Double-Ridged Waveguide Horn	ETS-LINDGREN	3117	00034609	Mar. 23, 2023	Mar. 22, 2024
RF Cable	Harbour	SHWCB-3000-N	N/A	Mar. 22, 2023	Mar. 21, 2025

Any report having not been signed by authorized approver, or having been altered without authorization, or having not been stamped by the "Dedicated Testing/Inspection Stamp" is deemed to be invalid. Copying or excerpting portion of, or altering the content of the report is not permitted without the written authorization of AGC. The test results presented in the report apply only to the tested sample. Any objections to report issued by AGC should be submitted to AGC within 15days after the issuance of the test report. Further enquiry of validity or verification of the test report should be addressed to AGC by agc01@agccert.com.

## 5. ETSI EN 300 328 REQUIREMENTS

### 5.1. RF OUTPUT POWER

#### 5.1.1 LIMIT

RF Output Power  $\leq$  100mW (20dBm) over Normal and Extreme conditions.

#### 5.1.2 MEASUREMENT PROCEDURE

- 1) Use a fast power sensor and set the samples speed 1MS/s or faster.
- 2) Connect one power sensor to each transmit port, Trigger the power sensors so that they start sampling at the same time. For each instant in time, sum the power of the individual samples of all ports and store them. Use these stored samples in all following steps.
- 3) Find the start and stop times of each burst in the stored measurement samples.
- 4) Between the start and stop times of each individual burst calculate the RMS power over the burst. Save these P burst values, as well as the start and stop times for each burst.
- 5) The highest of all P burst values (Value "A" in dBm) will be used for maximum e.i.r.p calculations.
- 6) The cable loss and attenuator factor shall be considered to the value "A".
- 6) Add the (stated) antenna assembly gain "G" in dBi of the individual antenna. If applicable, add the additional beamforming gain "Y" in dB.
- 7) The RF output power (P) shall be calculated using the formula:  $P=A+G+Y$

#### 5.1.3 TEST CONFIGURATION

##### Temperature and Voltage Measurement (under normal and extreme test conditions)

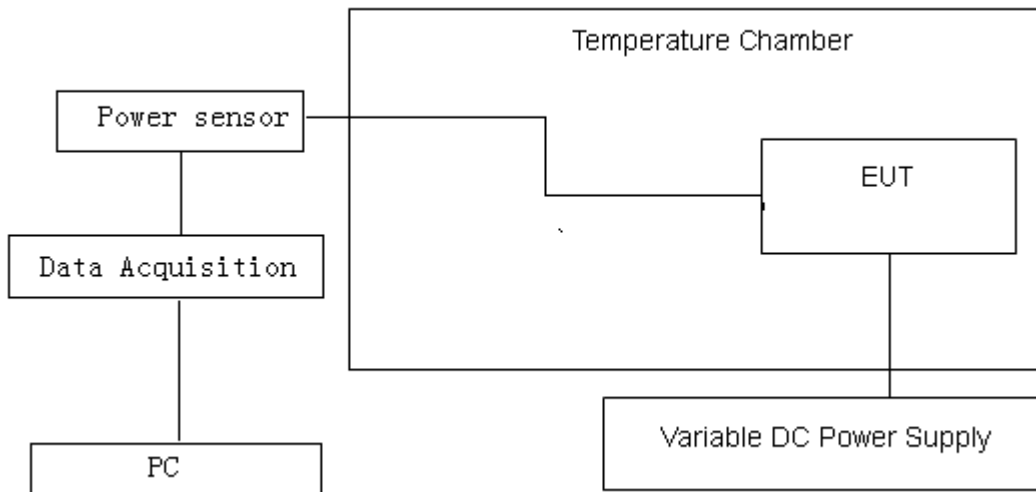

Any report having not been signed by authorized approver, or having been altered without authorization, or having not been stamped by the "Dedicated Testing/Inspection Stamp" is deemed to be invalid. Copying or excerpting portion of, or altering the content of the report is not permitted without the written authorization of AGC. The test results presented in the report apply only to the tested sample. Any objections to report issued by AGC should be submitted to AGC within 15days after the issuance of the test report. Further enquiry of validity or verification of the test report should be addressed to AGC by [agc01@agccert.com](mailto:agc01@agccert.com).

### 5.1.4 MEASUREMENT RESULTS

Test Data of RF Output Power					
Test Mode	RF Output Power [dBm]			Limit [dBm]	Verdict
	NT	LT	HT		
LE1M_TX_2402_1Mbps	0.92	0.90	0.92	20	Pass
LE1M_TX_2440_1Mbps	0.83	0.84	0.85	20	Pass
LE1M_TX_2480_1Mbps	1.37	1.39	1.37	20	Pass
LE2M_TX_2402_2Mbps	0.64	0.64	0.62	20	Pass
LE2M_TX_2440_2Mbps	0.56	0.60	0.56	20	Pass
LE2M_TX_2480_2Mbps	1.11	1.12	1.12	20	Pass

Any report having not been signed by authorized approver, or having been altered without authorization, or having not been stamped by the "Dedicated Testing/Inspection Stamp" is deemed to be invalid. Copying or excerpting portion of, or altering the content of the report is not permitted without the written authorization of AGC. The test results presented in the report apply only to the tested sample. Any objections to report issued by AGC should be submitted to AGC within 15days after the issuance of the test report. Further enquiry of validity or verification of the test report should be addressed to AGC by agc01@agccert.com.

### Test Graphs of RF Output Power

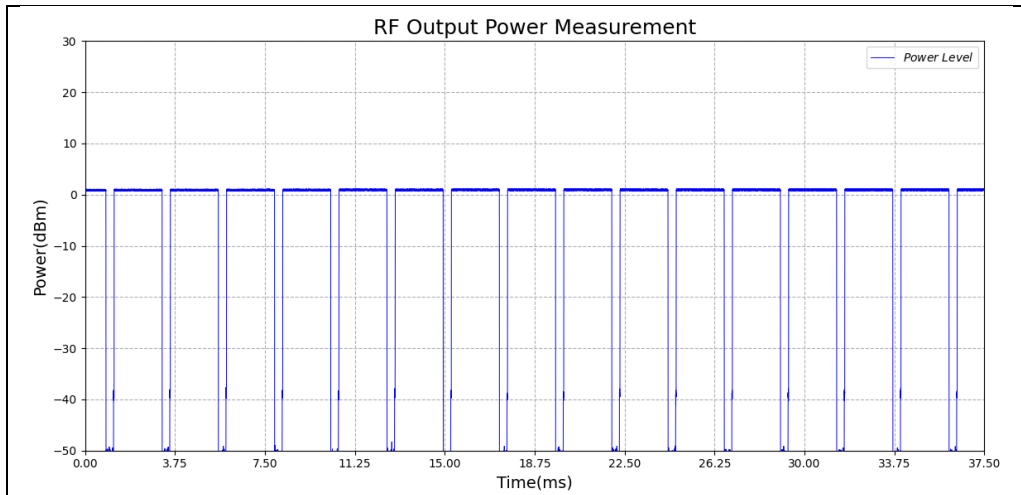

Test\_Graph\_LE1M\_TX\_2402\_1Mbps\_Power\_NT

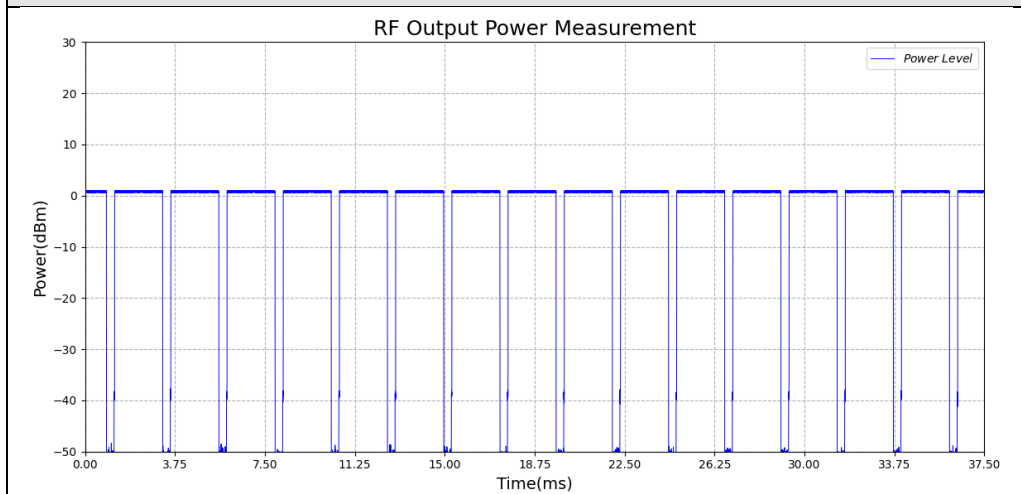

Test\_Graph\_LE1M\_TX\_2440\_1Mbps\_Power\_NT

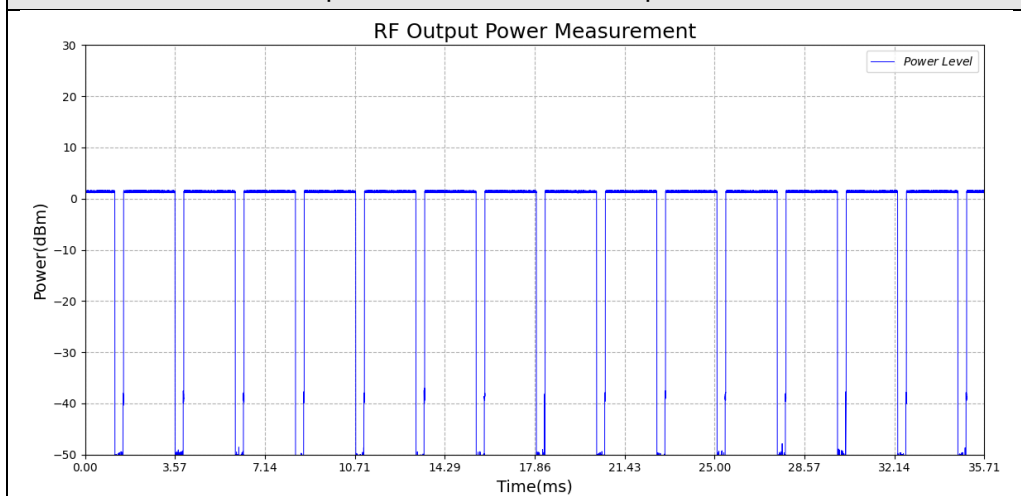

Test\_Graph\_LE1M\_TX\_2480\_1Mbps\_Power\_NT

Any report having not been signed by authorized approver, or having been altered without authorization, or having not been stamped by the "Dedicated Testing/Inspection Stamp" is deemed to be invalid. Copying or excerpting portion of, or altering the content of the report is not permitted without the written authorization of AGC. The test results presented in the report apply only to the tested sample. Any objections to report issued by AGC should be submitted to AGC within 15days after the issuance of the test report. Further enquiry of validity or verification of the test report should be addressed to AGC by agc01@agccert.com.

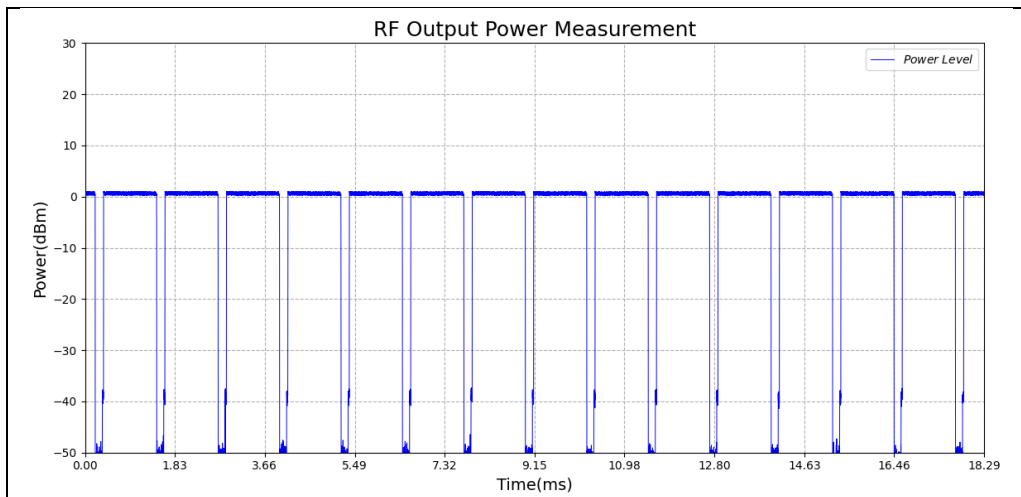

Test\_Graph\_LE2M\_TX\_2402\_2Mbps\_Power\_NT

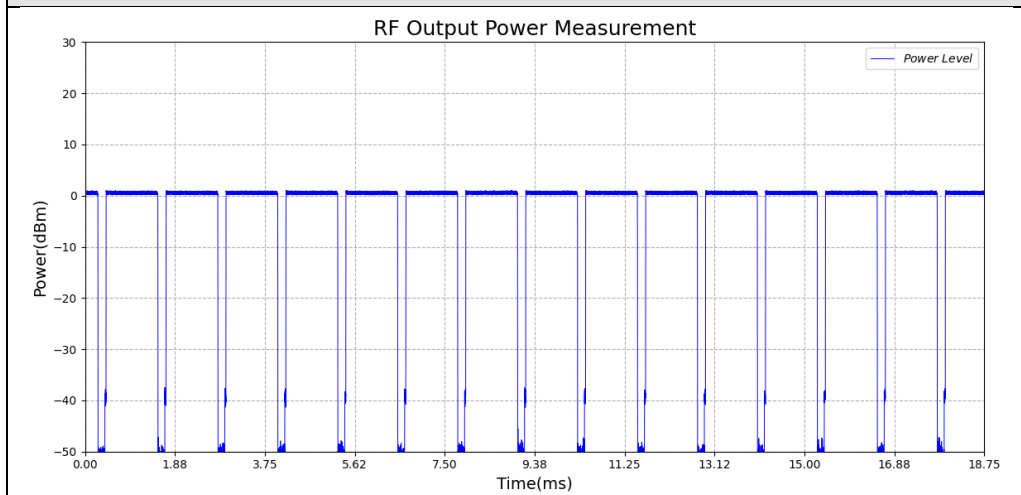

Test\_Graph\_LE2M\_TX\_2440\_2Mbps\_Power\_NT

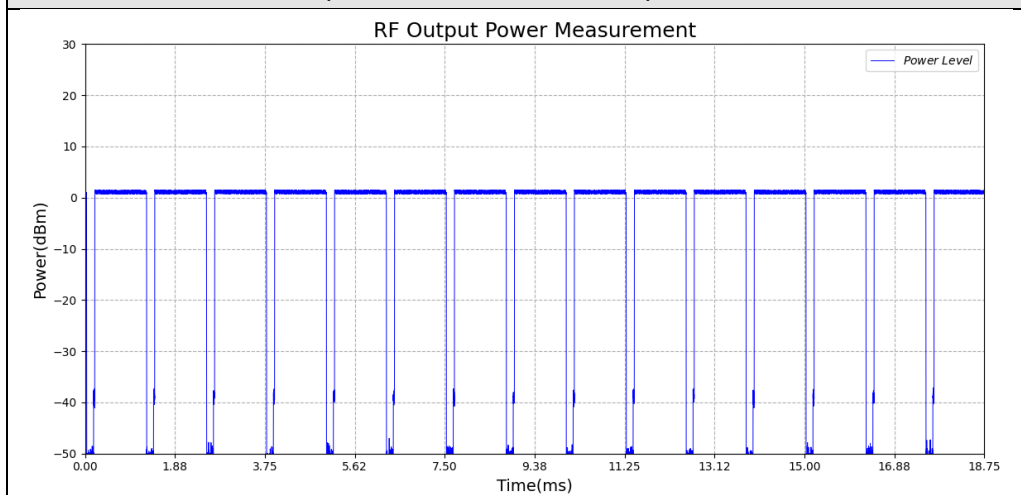

Test\_Graph\_LE2M\_TX\_2480\_2Mbps\_Power\_NT

Note: Only the data of worst case is reported as above.

Any report having not been signed by authorized approver, or having been altered without authorization, or having not been stamped by the "Dedicated Testing/Inspection Stamp" is deemed to be invalid. Copying or excerpting portion of, or altering the content of the report is not permitted without the written authorization of AGC. The test results presented in the report apply only to the tested sample. Any objections to report issued by AGC should be submitted to AGC within 15days after the issuance of the test report. Further enquiry of validity or verification of the test report should be addressed to AGC by agc01@agccert.com.

## 5.2. POWER SPECTRAL DENSITY

### 5.2.1 LIMIT

For non-adaptive equipment using wide band modulations other than FHSS, the maximum Power spectral density is limited to 10mW Per MHz

### 5.2.2 TEST PROCEDURE

- 1) Set the frequency from 2400MHz to 2483.5MHz, use 10kHz RBW and 30kHz VBW for pre-scan. The number of sweep points shall be more than 8350. Wait for the trace to be completed and save the (trace) data set to a file.
- 2) Add up the values for amplitude (power) for all the samples in the file.
- 3) Normalize the individual values for amplitude so that the sum is equal to the RF Output Power (e.i.r.p) measured in 5.1.
- 4) Starting from the first sample in the file (lowest frequency), add up the power of the following samples representing a 1MHz segment and record the results for power and position (i.e. sample #1 to #100). This is the Power Spectral Density (e.i.r.p) for the first 1MHz segment which shall be recorded.
- 5) Shift the start point of the samples added up in step 5 by 1 sample and repeat the procedure in step 4(i.e. sample #2 to #101).
- 6) Repeat step 5 until the end of the data set and record the radiated power spectral Density values for each of the 1MHz segments.
- 7) The cable loss and attenuator factor shall be considered to the test result.
- 8) The highest value shall be recorded in the test report.

### 5.2.3 TEST CONFIGURATION

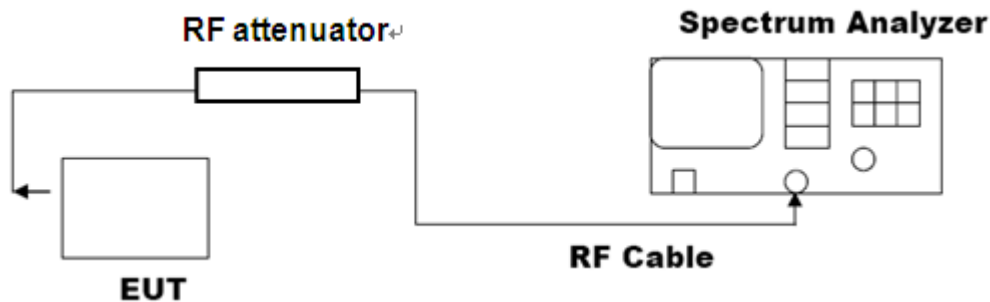

### 5.2.4 TEST RESULTS

Test Data of Power Spectral Density			
Test Mode	Power Spectral Density [dBm/MHz]	Limit [dBm/MHz]	Verdict
LE1M_TX_2402_1Mbps	0.85	10	Pass
LE1M_TX_2440_1Mbps	0.76	10	Pass
LE1M_TX_2480_1Mbps	1.30	10	Pass
LE2M_TX_2402_2Mbps	-0.51	10	Pass
LE2M_TX_2440_2Mbps	-0.61	10	Pass
LE2M_TX_2480_2Mbps	-0.04	10	Pass

Any report having not been signed by authorized approver, or having been altered without authorization, or having not been stamped by the "Dedicated Testing/Inspection Stamp" is deemed to be invalid. Copying or excerpting portion of, or altering the content of the report is not permitted without the written authorization of AGC. The test results presented in the report apply only to the tested sample. Any objections to report issued by AGC should be submitted to AGC within 15days after the issuance of the test report. Further enquiry of validity or verification of the test report should be addressed to AGC by agc01@agccert.com.

### Test Graphs of Power Spectral Density

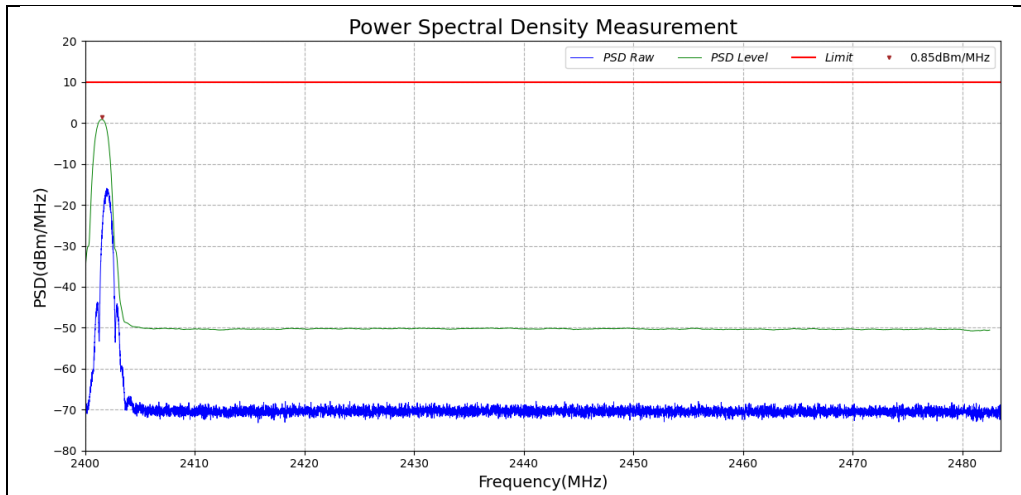

Test\_Graph\_LE1M\_TX\_2402\_1Mbps\_PSD

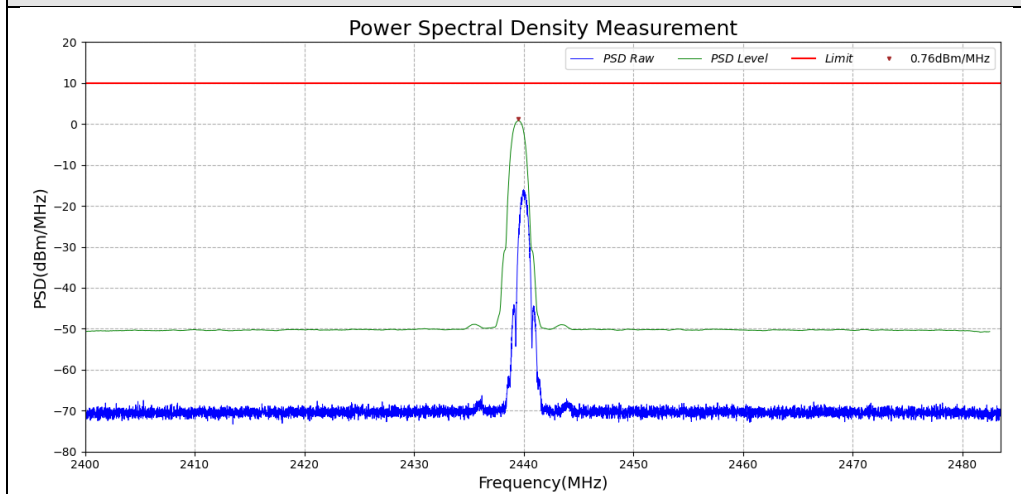

Test\_Graph\_LE1M\_TX\_2440\_1Mbps\_PSD

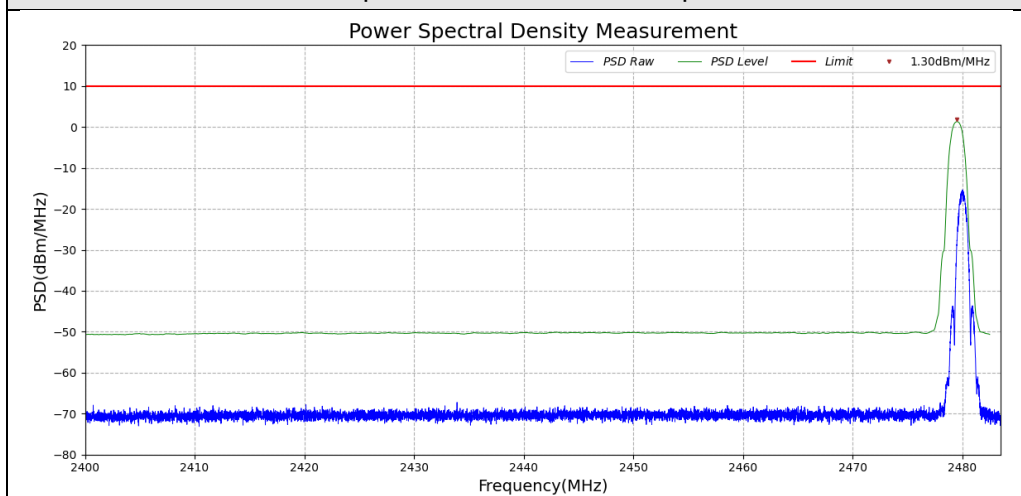

Test\_Graph\_LE1M\_TX\_2480\_1Mbps\_PSD

Any report having not been signed by authorized approver, or having been altered without authorization, or having not been stamped by the "Dedicated Testing/Inspection Stamp" is deemed to be invalid. Copying or excerpting portion of, or altering the content of the report is not permitted without the written authorization of AGC. The test results presented in the report apply only to the tested sample. Any objections to report issued by AGC should be submitted to AGC within 15 days after the issuance of the test report. Further enquiry of validity or verification of the test report should be addressed to AGC by agc01@agccert.com.

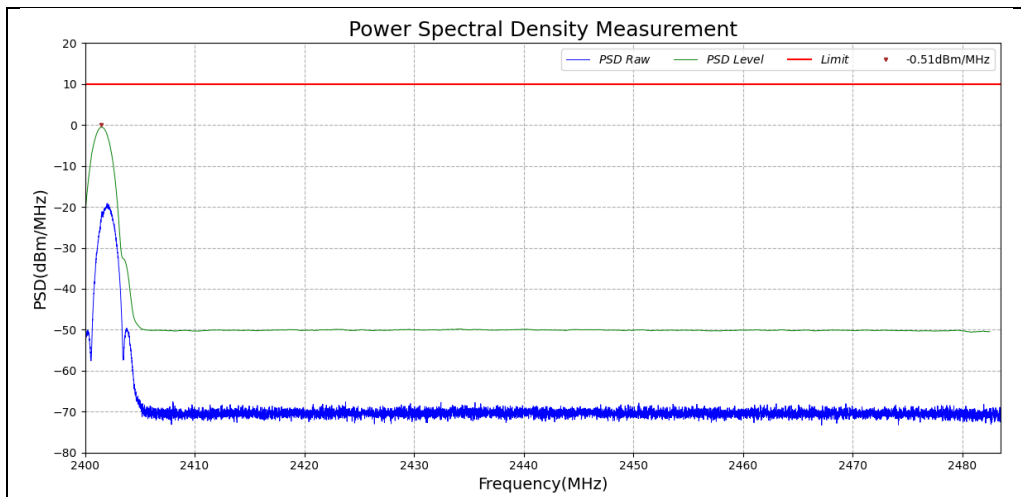

Test\_Graph\_LE2M\_TX\_2402\_2Mbps\_PSD

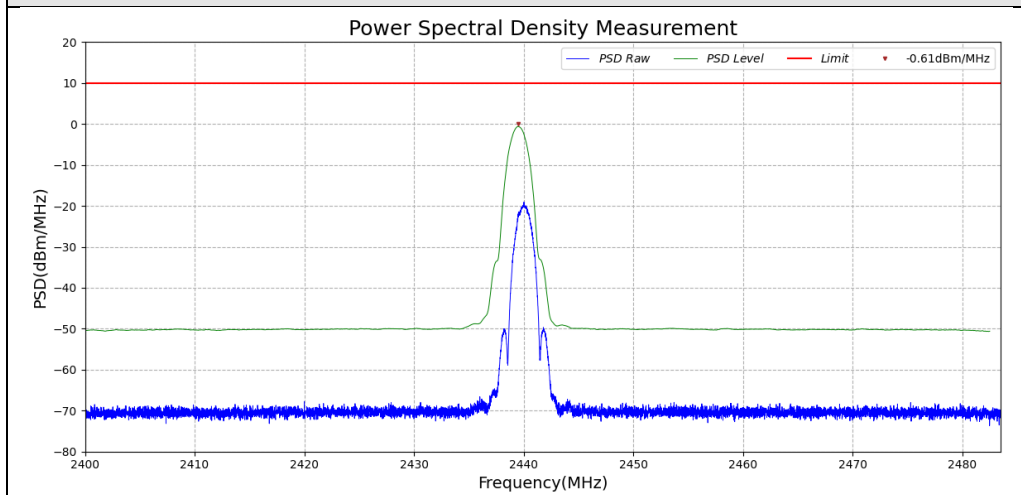

Test\_Graph\_LE2M\_TX\_2440\_2Mbps\_PSD

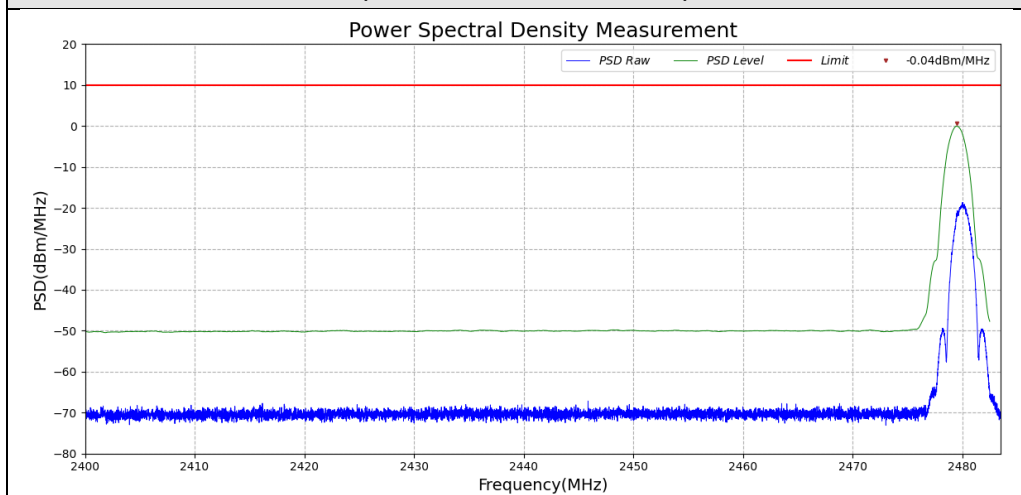

Test\_Graph\_LE2M\_TX\_2480\_2Mbps\_PSD

Any report having not been signed by authorized approver, or having been altered without authorization, or having not been stamped by the "Dedicated Testing/Inspection Stamp" is deemed to be invalid. Copying or excerpting portion of, or altering the content of the report is not permitted without the written authorization of AGC. The test results presented in the report apply only to the tested sample. Any objections to report issued by AGC should be submitted to AGC within 15days after the issuance of the test report. Further enquiry of validity or verification of the test report should be addressed to AGC by agc01@agccert.com.



### 5.3. ADAPTIVITY

The method of adaptivity is using LBT based on LBE.

#### 5.3.1 LIMIT

The Channel Occupancy Time shall be less than 13ms.

If implemented, Short Control Signalling Transmissions of adaptive equipment using wide band modulations other than FHSS shall have a maximum duty cycle of 10 % within an observation period of 50 ms.

For power levels less than 20 dBm e.i.r.p., the CCA threshold level (TL) may be relaxed to:

$$TL = -70 \text{ dBm/MHz} + 10 \times \log_{10} (100 \text{ mW} / P_{out}) \text{ (Pout in mW e.i.r.p.)}$$

An unwanted CW signal as defined in the below table.

Wanted signal mean power from companion device	Unwanted signal frequency (MHz)	Unwanted signal power (dBm)
sufficient to maintain the link (see note 2)	2 395 or 2 488,5 (see note 1)	-35 (see note 3)
<p>NOTE 1: The highest frequency shall be used for testing operating channels within the range 2 400 MHz to 2 442 MHz, while the lowest frequency shall be used for testing operating channels within the range 2 442 MHz to 2 483,5 MHz. See clause 5.4.6.1.</p> <p>NOTE 2: A typical conducted value which can be used in most cases is -50 dBm/MHz.</p> <p>NOTE 3: The level specified is the level at the UUT receiver input assuming a 0 dBi antenna assembly gain. In case of conducted measurements, this level has to be corrected for the (in-band) antenna assembly gain (G). In case of radiated measurements, this level is equivalent to a power flux density (PFD) in front of the UUT antenna.</p>		

#### 5.3.2 TEST PROCEDURE

- 1) The EUT connect to a companion device during the test. Adjust the received signal level at the EuT to the value of -50dBm/MHz.
- 2) the analyzer shall be set as below: RBW>=Occupied Channel Bandwidth (if the analyser does not support this setting, the highest available setting shall be used) and VBW>=3 × RBW.
- 3) Configure the EUT for normal transmission with a sufficiently high payload to allow demonstration of compliance of the adaptive mechanism on the channel being tested.
- 4) Adding the interference signal and verification of reaction to the interference signal.
- 5) Adding the unwanted signal and verification of reaction to the unwanted signal.
- 6) Removing the interference and unwanted signal.

Any report having not been signed by authorized approver, or having been altered without authorization, or having not been stamped by the “Dedicated Testing/Inspection Stamp” is deemed to be invalid. Copying or excerpting portion of, or altering the content of the report is not permitted without the written authorization of AGC. The test results presented in the report apply only to the tested sample. Any objections to report issued by AGC should be submitted to AGC within 15days after the issuance of the test report. Further enquiry of validity or verification of the test report should be addressed to AGC by agc01@agccert.com.

### 5.3.3 TEST CONFIGURATION

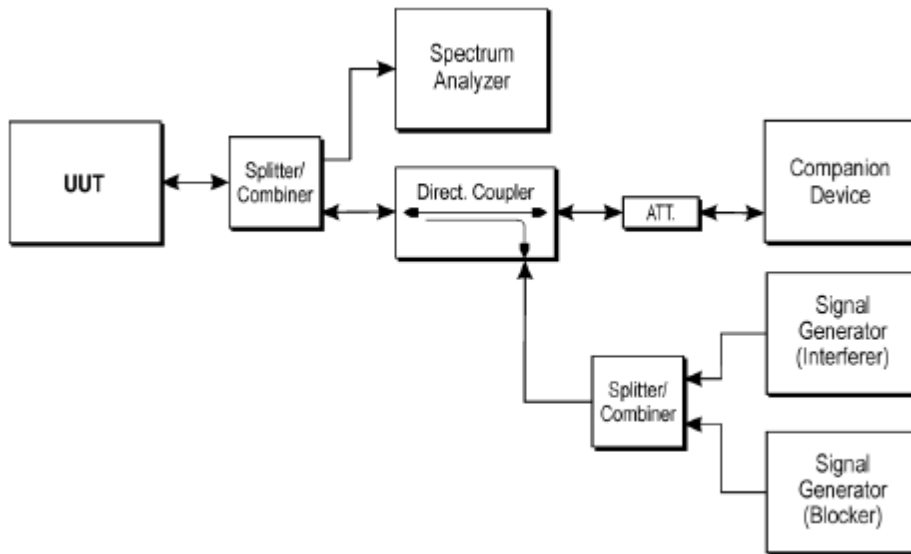

### 5.3.4 TEST RESULTS

The EIRP of the EUT is less than 10dBm/MHz, So the adaptivity test is not applicable for the EUT.

Any report having not been signed by authorized approver, or having been altered without authorization, or having not been stamped by the "Dedicated Testing/Inspection Stamp" is deemed to be invalid. Copying or excerpting portion of, or altering the content of the report is not permitted without the written authorization of AGC. The test results presented in the report apply only to the tested sample. Any objections to report issued by AGC should be submitted to AGC within 15days after the issuance of the test report. Further enquiry of validity or verification of the test report should be addressed to AGC by [agc01@agccert.com](mailto:agc01@agccert.com).

## 5.4. OCCUPIED CHANNEL BANDWIDTH

### 5.4.1 LIMIT

The Occupied Channel Bandwidth shall fall completely within the band 2400MHz to 2483.5MHz.

### 5.4.2 TEST PROCEDURE

1)The spectrum analyser shall be used the following settings:

Centre Frequency: The centre frequency of the channel under test

Resolution BW: ~1% of the span without going below 1%

Video BW:  $3 \times RBW$

Span:  $2 \times OBW$

Detector: RMS

Trace mode: Max Hold

2) Wait until the trace is completed, find the peak value of the trace and place the analyser marker on this peak.

3) Use the 99 % bandwidth function of the spectrum analyser to measure the Occupied Channel Bandwidth of the UUT. This value shall be recorded.

### 5.4.3 TEST CONFIGURATION

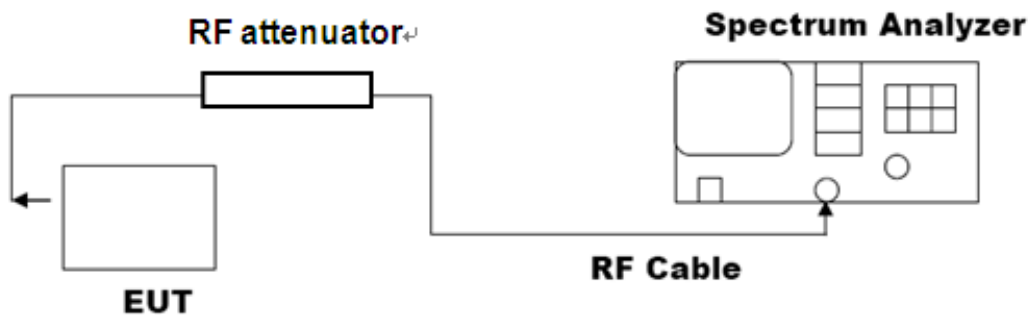

### 5.4.4 TEST RESULTS

Test Data of Occupied Channel Bandwidth					
Test Mode	Occupied Channel Bandwidth [MHz]			Limit [MHz]	Verdict
	OCB	FL	FH		
LE1M_TX_2402_1Mbps	1.054	2401.496	2402.550	2400 to 2483.5	Pass
LE1M_TX_2480_1Mbps	1.053	2479.497	2480.550	2400 to 2483.5	Pass
LE2M_TX_2402_2Mbps	2.049	2401.000	2403.049	2400 to 2483.5	Pass
LE2M_TX_2480_2Mbps	2.048	2479.001	2481.049	2400 to 2483.5	Pass

Any report having not been signed by authorized approver, or having been altered without authorization, or having not been stamped by the "Dedicated Testing/Inspection Stamp" is deemed to be invalid. Copying or excerpting portion of, or altering the content of the report is not permitted without the written authorization of AGC. The test results presented in the report apply only to the tested sample. Any objections to report issued by AGC should be submitted to AGC within 15days after the issuance of the test report. Further enquiry of validity or verification of the test report should be addressed to AGC by agc01@agccert.com.

Attestation of Global Compliance(Shenzhen)Co., Ltd

Attestation of Global Compliance(Shenzhen)Std & Tech Co., Ltd

Tel: +86-755 2523 4088 E-mail: agc@agccert.com Web: http://www.agccert.com/

### Test Graphs of Occupied Channel Bandwidth



Test\_Graph\_LE1M\_TX\_2402\_1Mbps\_OBW

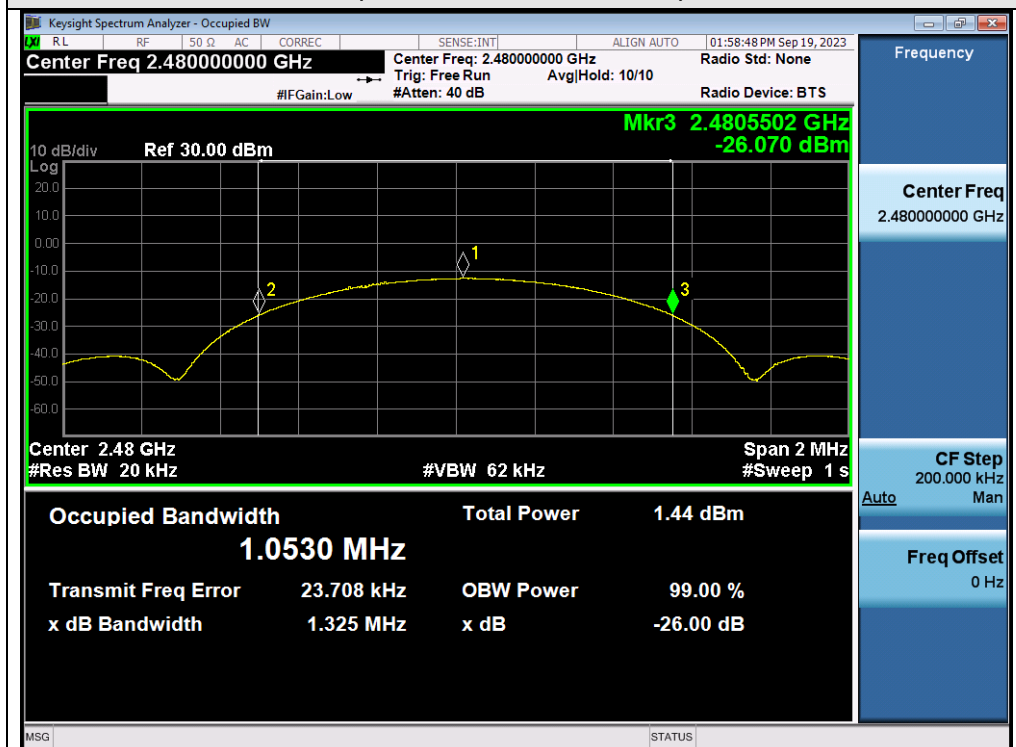

Test\_Graph\_LE1M\_TX\_2480\_1Mbps\_OBW

Any report having not been signed by authorized approver, or having been altered without authorization, or having not been stamped by the "Dedicated Testing/Inspection Stamp" is deemed to be invalid. Copying or excerpting portion of, or altering the content of the report is not permitted without the written authorization of AGC. The test results presented in the report apply only to the tested sample. Any objections to report issued by AGC should be submitted to AGC within 15days after the issuance of the test report. Further enquiry of validity or verification of the test report should be addressed to AGC by agc01@agccert.com.

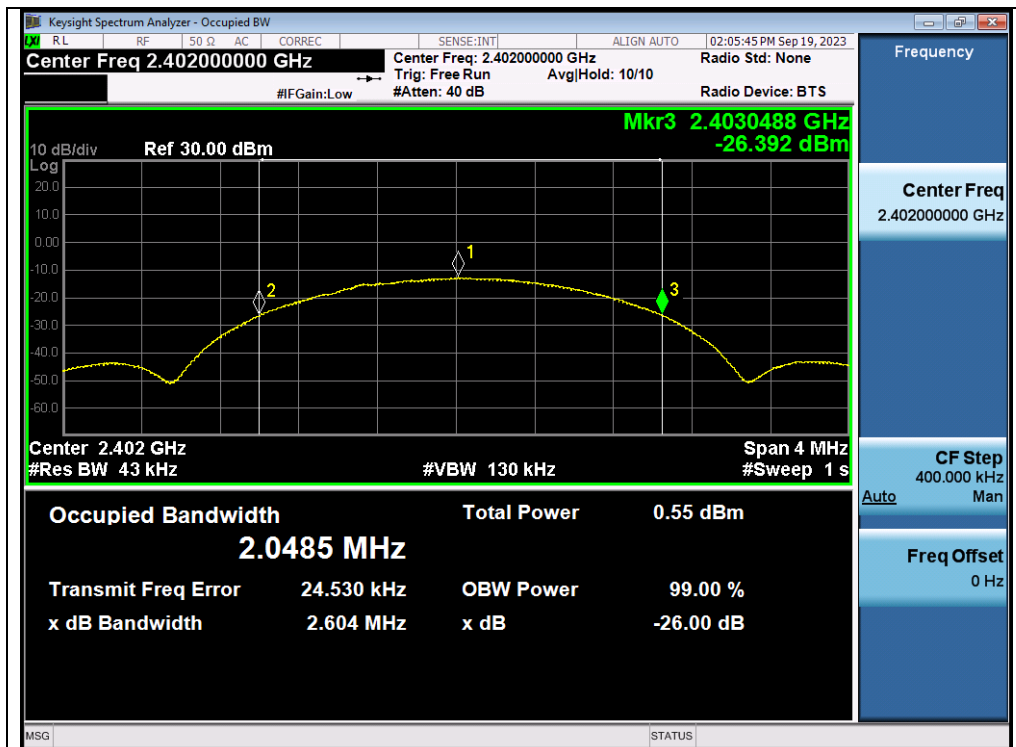

Test\_Graph\_LE2M\_TX\_2402\_2Mbps\_OBW



Test\_Graph\_LE2M\_TX\_2480\_2Mbps\_OBW

Any report having not been signed by authorized approver, or having been altered without authorization, or having not been stamped by the "Dedicated Testing/Inspection Stamp" is deemed to be invalid. Copying or excerpting portion of, or altering the content of the report is not permitted without the written authorization of AGC. The test results presented in the report apply only to the tested sample. Any objections to report issued by AGC should be submitted to AGC within 15days after the issuance of the test report. Further enquiry of validity or verification of the test report should be addressed to AGC by agc01@agccert.com.

## 5.5. TRANSMITTER UNWANTED EMISSIONS IN THE OUT-OF-BAND DOMAIN

### 5.5.1 LIMIT

The transmitter unwanted emissions in the out-of-band domain but outside the allocated band, shall not exceed the values provided by the mask.

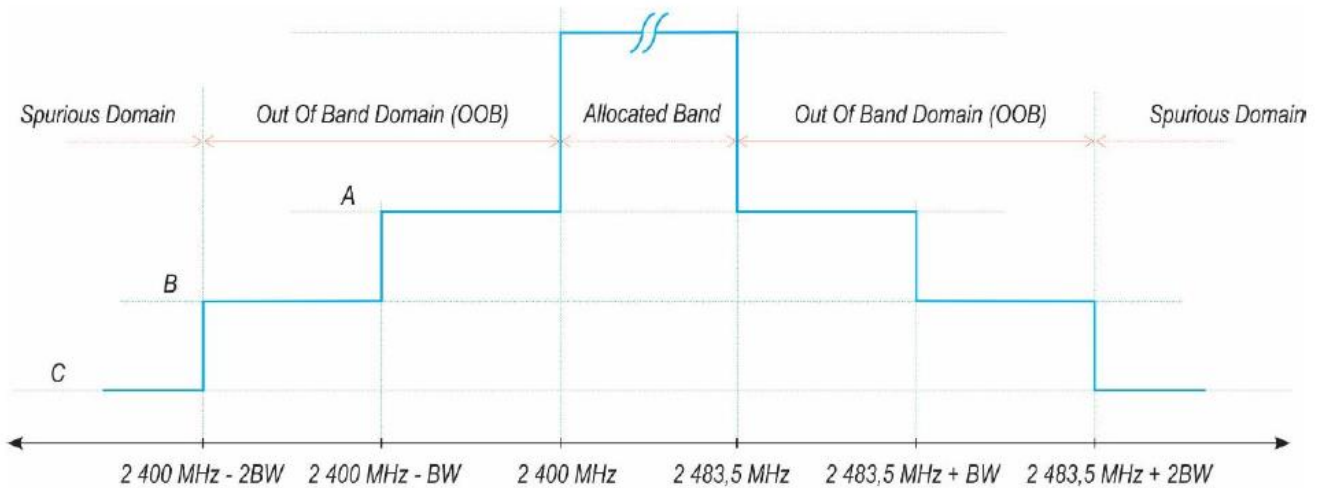

A:  $-10\text{ dBm/MHz e.i.r.p.}$   
B:  $-20\text{ dBm/MHz e.i.r.p.}$   
C: Spurious Domain limits

$BW = \text{Occupied Channel Bandwidth in MHz or } 1\text{ MHz whichever is greater}$

Any report having not been signed by authorized approver, or having been altered without authorization, or having not been stamped by the "Dedicated Testing/Inspection Stamp" is deemed to be invalid. Copying or excerpting portion of, or altering the content of the report is not permitted without the written authorization of AGC. The test results presented in the report apply only to the tested sample. Any objections to report issued by AGC should be submitted to AGC within 15days after the issuance of the test report. Further enquiry of validity or verification of the test report should be addressed to AGC by [agc01@agccert.com](mailto:agc01@agccert.com).

### 5.5.2 TEST PROCEDURE

1) The spectrum analyser shall be used the following settings:

Centre Frequency: 2484MHz

Resolution BW: 1MHz; Video BW: 3MHz; Span: 0Hz; Detector: RMS

Trace mode: Max Hold; Sweep Points: 5000

2) (segment 2 483.5 MHz to 2 483.5 MHz + BW)

Adjust the trigger level to select the transmissions with the highest power level.

Increase the centre frequency in steps of 1 MHz and repeat this measurement for every 1 MHz segment within the range 2 483.5 MHz to 2 483.5 MHz + BW.

3)Segment 2 483.5 MHz + BW to 2 483.5 MHz + 2BW

Change the centre frequency of the analyser to 2 484 MHz + BW and perform the measurement for the first 1 MHz segment within range 2 483.5 MHz + BW to 2 483.5 MHz + 2BW. Increase the centre frequency in 1 MHz steps and repeat the measurements to cover this whole range. The centre frequency of the last 1 MHz segment shall be set to 2 483,5 MHz + 2 BW – 0.5 MHz.

4)Segment 2 400 MHz - BW to 2 400 MHz

Change the centre frequency of the analyser to 2 399.5 MHz and perform the measurement for the first 1 MHz segment within range 2 400 MHz - BW to 2 400 MHz Reduce the centre frequency in 1 MHz steps and repeat the measurements to cover this whole range. The centre frequency of the last 1 MHz segment shall be set to 2 400 MHz - 2BW + 0.5 MHz.

5)Segment 2 400 MHz - 2BW to 2 400 MHz - BW

Change the centre frequency of the analyser to 2 399,5 MHz - BW and perform the measurement for the first 1 MHz segment within range 2 400 MHz - 2BW to 2 400 MHz - BW. Reduce the centre frequency in 1 MHz steps and repeat the measurements to cover this whole range. The centre frequency of the last 1 MHz segment shall be set to 2 400 MHz - 2BW + 0.5 MHz.

6)The cable loss and attenuator factor shall be considered to the test result.

### 5.5.3 TEST CONFIGURATION

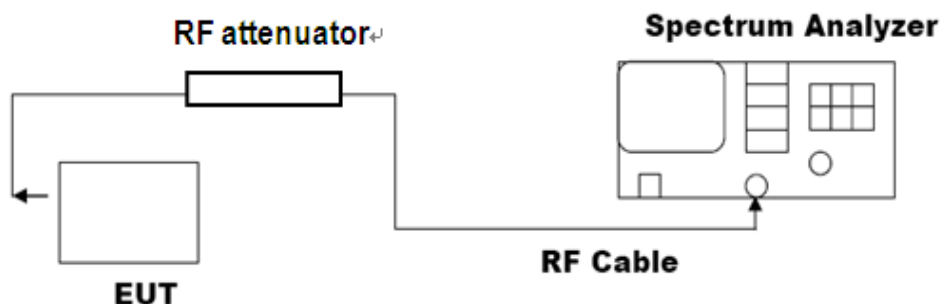

Any report having not been signed by authorized approver, or having been altered without authorization, or having not been stamped by the “Dedicated Testing/Inspection Stamp” is deemed to be invalid. Copying or excerpting portion of, or altering the content of the report is not permitted without the written authorization of AGC. The test results presented in the report apply only to the tested sample. Any objections to report issued by AGC should be submitted to AGC within 15days after the issuance of the test report. Further enquiry of validity or verification of the test report should be addressed to AGC by agc01@agccert.com.

Attestation of Global Compliance(Shenzhen)Co., Ltd

Attestation of Global Compliance(Shenzhen)Std & Tech Co., Ltd

Tel: +86-755 2523 4088 E-mail: agc@agccert.com Web: http://www.agccert.com/

**5.5.4 TEST RESULT**

Test Data of OOB Emissions				
Test Mode	Frequency [MHz]	Level [dBm]	Limit [dBm]	Verdict
LE1M_TX_2402_1Mbps	2399.500	-46.43	-10	Pass
	2399.446	-46.88	-10	Pass
	2398.446	-50.79	-20	Pass
	2398.392	-51.39	-20	Pass
	2484.000	-60.18	-10	Pass
	2484.054	-59.56	-10	Pass
	2485.054	-60.60	-20	Pass
	2485.108	-60.65	-20	Pass
LE1M_TX_2480_1Mbps	2399.500	-59.83	-10	Pass
	2399.447	-59.93	-10	Pass
	2398.447	-59.79	-20	Pass
	2398.394	-59.95	-20	Pass
	2484.000	-53.47	-10	Pass
	2484.053	-53.36	-10	Pass
	2485.053	-54.41	-20	Pass
	2485.106	-54.66	-20	Pass
LE2M_TX_2402_2Mbps	2399.500	-33.55	-10	Pass
	2398.500	-46.78	-10	Pass
	2398.451	-47.18	-10	Pass
	2397.451	-53.52	-20	Pass
	2396.451	-55.92	-20	Pass
	2396.402	-55.97	-20	Pass
	2484.000	-60.97	-10	Pass
	2485.000	-60.70	-10	Pass
	2485.049	-60.45	-10	Pass
	2486.049	-60.87	-20	Pass
	2487.049	-60.23	-20	Pass
	2487.098	-59.70	-20	Pass
LE2M_TX_2480_2Mbps	2399.500	-60.07	-10	Pass
	2398.500	-59.25	-10	Pass
	2398.452	-59.89	-10	Pass
	2397.452	-60.12	-20	Pass
	2396.452	-59.98	-20	Pass
	2396.404	-59.53	-20	Pass

Any report having not been signed by authorized approver, or having been altered without authorization, or having not been stamped by the "Dedicated Testing/Inspection Stamp" is deemed to be invalid. Copying or excerpting portion of, or altering the content of the report is not permitted without the written authorization of AGC. The test results presented in the report apply only to the tested sample. Any objections to report issued by AGC should be submitted to AGC within 15days after the issuance of the test report. Further enquiry of validity or verification of the test report should be addressed to AGC by agc01@agccert.com.



	2484.000	-52.04	-10	Pass
	2485.000	-55.32	-10	Pass
	2485.048	-55.45	-10	Pass
	2486.048	-55.35	-20	Pass
	2487.048	-56.27	-20	Pass
	2487.096	-55.28	-20	Pass

### Test Graphs of OOB Emissions

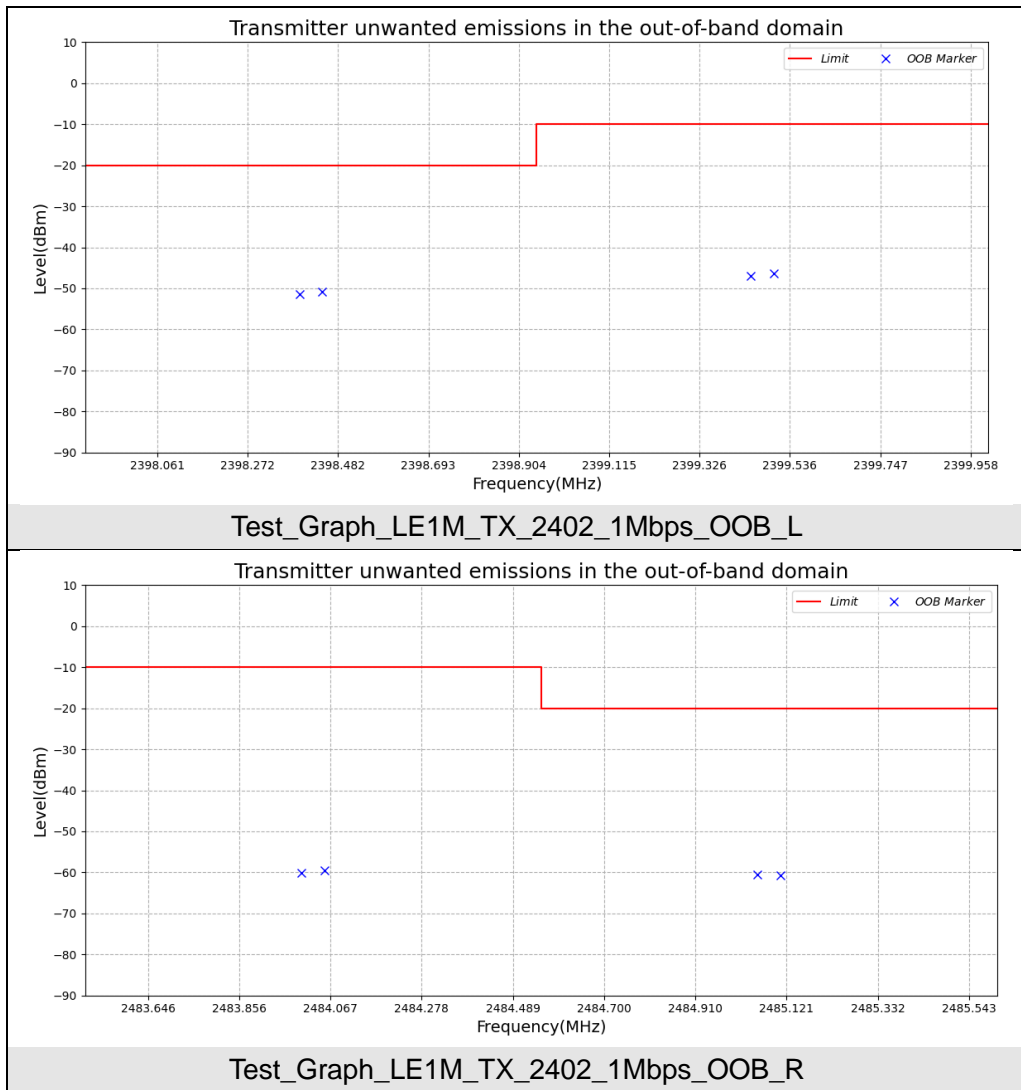

Any report having not been signed by authorized approver, or having been altered without authorization, or having not been stamped by the "Dedicated Testing/Inspection Stamp" is deemed to be invalid. Copying or excerpting portion of, or altering the content of the report is not permitted without the written authorization of AGC. The test results presented in the report apply only to the tested sample. Any objections to report issued by AGC should be submitted to AGC within 15days after the issuance of the test report. Further enquiry of validity or verification of the test report should be addressed to AGC by agc01@agccert.com.

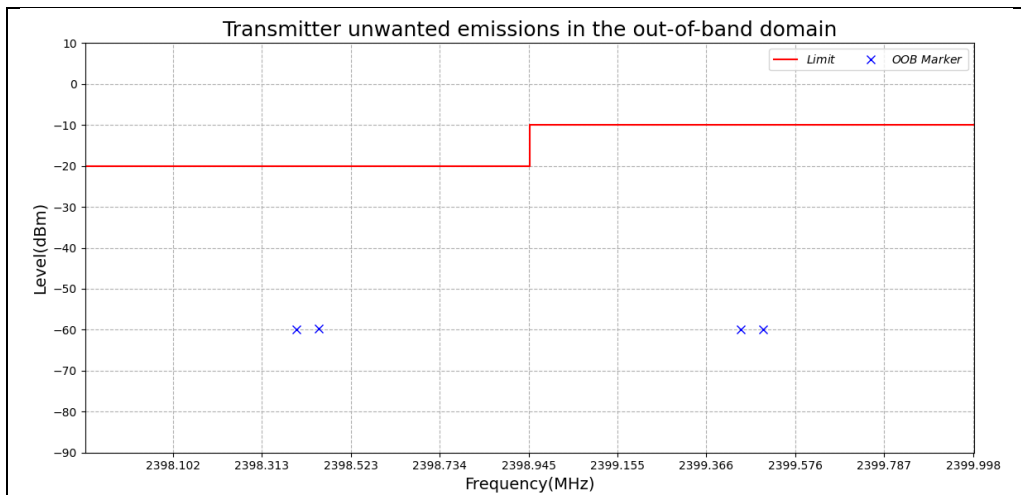

Test\_Graph\_LE1M\_TX\_2480\_1Mbps\_OOB\_L

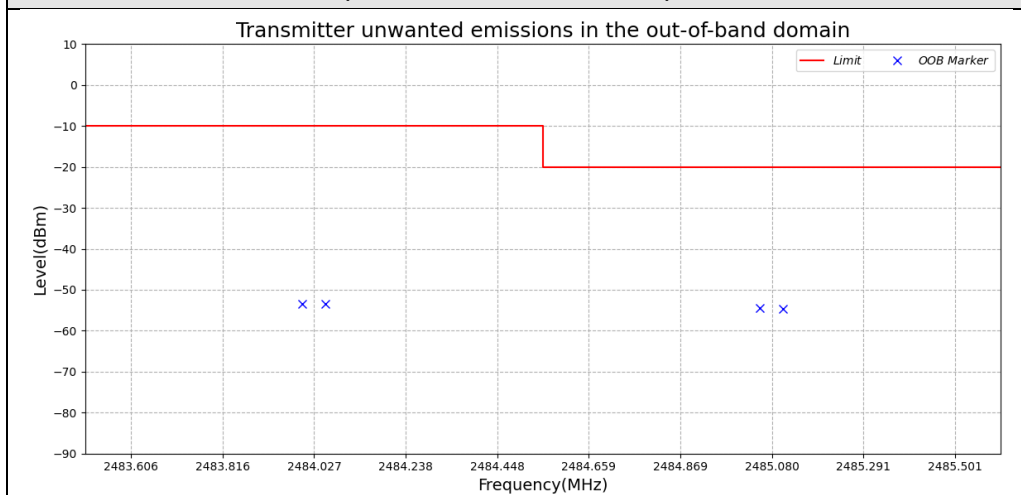

Test\_Graph\_LE1M\_TX\_2480\_1Mbps\_OOB\_R

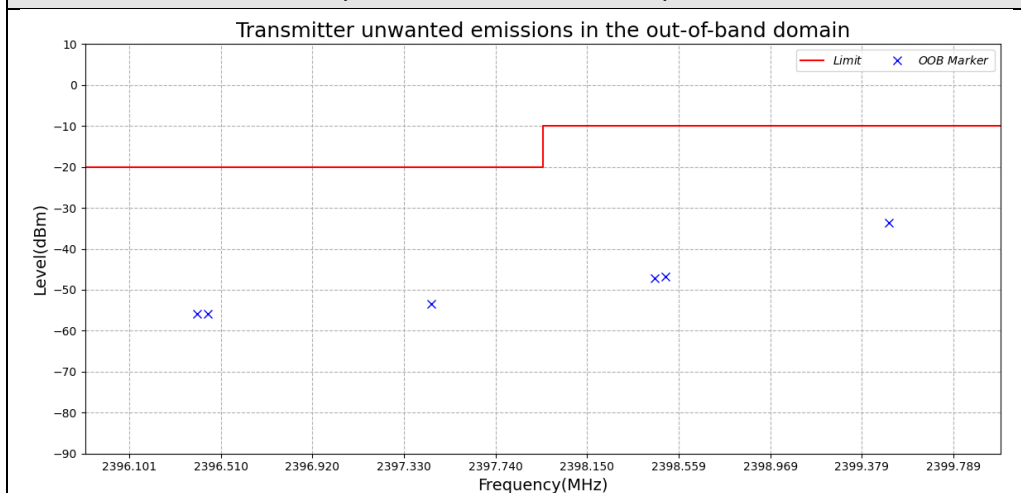

Test\_Graph\_LE2M\_TX\_2402\_2Mbps\_OOB\_L

Any report having not been signed by authorized approver, or having been altered without authorization, or having not been stamped by the "Dedicated Testing/Inspection Stamp" is deemed to be invalid. Copying or excerpting portion of, or altering the content of the report is not permitted without the written authorization of AGC. The test results presented in the report apply only to the tested sample. Any objections to report issued by AGC should be submitted to AGC within 15days after the issuance of the test report. Further enquiry of validity or verification of the test report should be addressed to AGC by agc01@agccert.com.

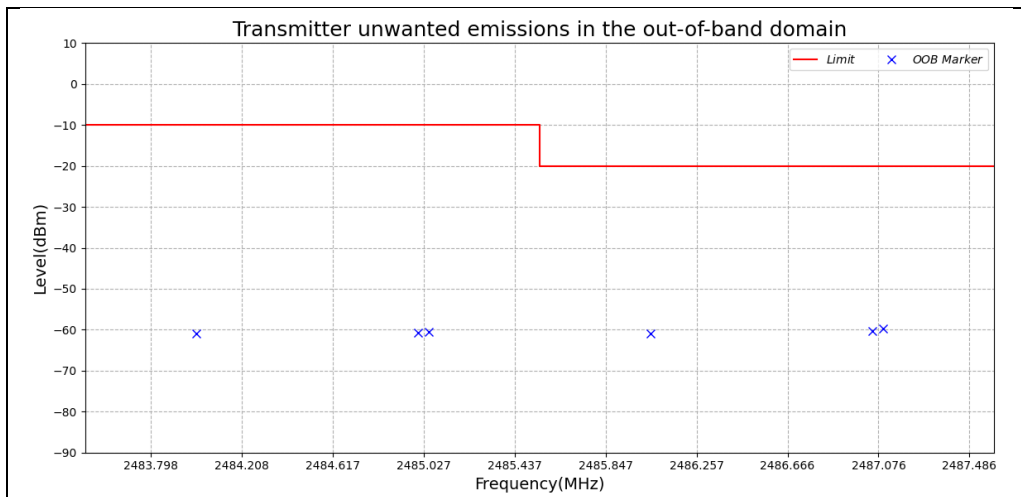

Test\_Graph\_LE2M\_TX\_2402\_2Mbps\_OOB\_R

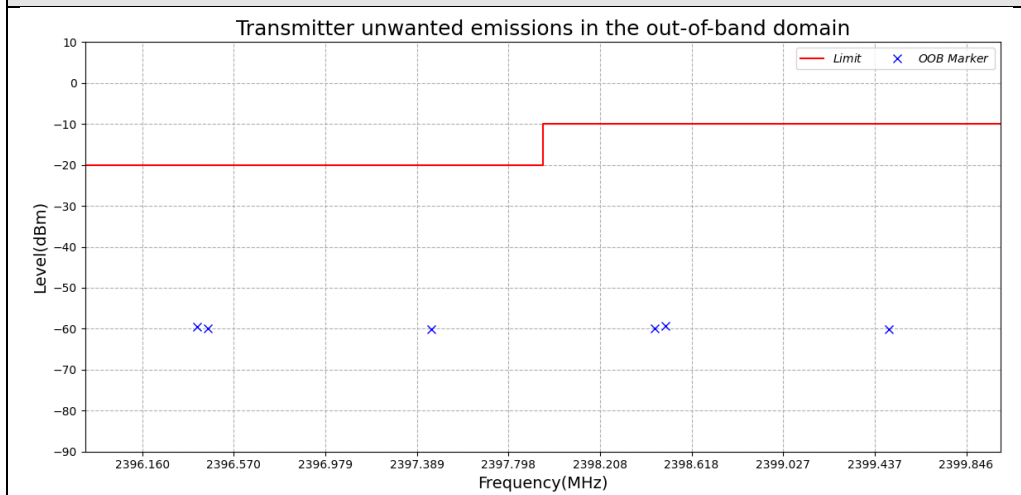

Test\_Graph\_LE2M\_TX\_2480\_2Mbps\_OOB\_L

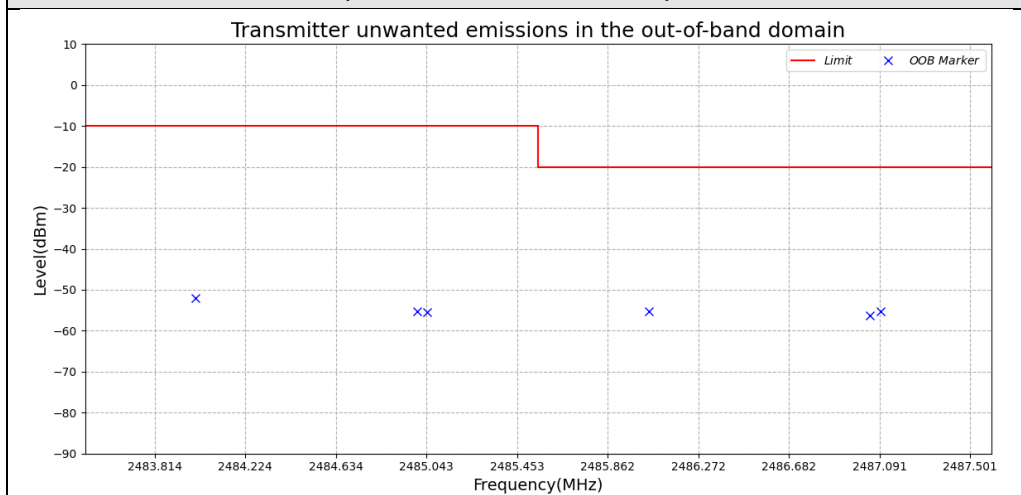

Test\_Graph\_LE2M\_TX\_2480\_2Mbps\_OOB\_R

Any report having not been signed by authorized approver, or having been altered without authorization, or having not been stamped by the "Dedicated Testing/Inspection Stamp" is deemed to be invalid. Copying or excerpting portion of, or altering the content of the report is not permitted without the written authorization of AGC. The test results presented in the report apply only to the tested sample. Any objections to report issued by AGC should be submitted to AGC within 15days after the issuance of the test report. Further enquiry of validity or verification of the test report should be addressed to AGC by agc01@agccert.com.

## 5.6. TRANSMITTER UNWANTED EMISSIONS IN THE SPURIOUS DOMAIN

### 5.6.1 LIMIT

The spurious emissions of the transmitter shall not exceed the values in tables in the indicated bands:

Frequency Range	Maximum Power e.r.p(<=1GHz)/e.i.r.p(>1GHz)	Bandwidth
30 MHz to 47 MHz	-36dBm	100kHz
47 MHz to 74 MHz	-54dBm	100kHz
74 MHz to 87.5 MHz	-36dBm	100kHz
87.5 MHz to 118 MHz	-54dBm	100kHz
118 MHz to 174 MHz	-36dBm	100kHz
174 MHz to 230 MHz	-54dBm	100kHz
230 MHz to 470 MHz	-36dBm	100kHz
470 MHz to 694 MHz	-54dBm	100kHz
694 MHz to 1GHz	-36dBm	100kHz
1 GHz to 12.75 GHz	-30dBm	1MHz

Any report having not been signed by authorized approver, or having been altered without authorization, or having not been stamped by the "Dedicated Testing/Inspection Stamp" is deemed to be invalid. Copying or excerpting portion of, or altering the content of the report is not permitted without the written authorization of AGC. The test results presented in the report apply only to the tested sample. Any objections to report issued by AGC should be submitted to AGC within 15days after the issuance of the test report. Further enquiry of validity or verification of the test report should be addressed to AGC by agc01@agccert.com.

### 5.6.2 TEST PROCEDURE

- 1) The emissions over the range 30 MHz to 1 000 MHz shall be identified.
- 2) Spectrum analyzer settings:
  - Resolution bandwidth: 100 kHz
  - Video bandwidth: 300 kHz
  - Detector mode: Peak
  - Sweep Points:  $\geq 19\ 400$
  - Trace Mode: Max Hold
- 3) Allow the trace to stabilize. Any emissions identified during the sweeps above and that fall within the 6 dB range below the applicable limit or above, shall be individually measured using RMS detector and compared to the limits.
- 4) The emissions over the range 1 GHz to 12,75 GHz shall be identified.
- 5) Resolution bandwidth: 1 MHz
  - Video bandwidth: 3 MHz
  - Detector mode: Peak
  - Trace Mode: Max Hold
  - Sweep Points:  $\geq 23\ 500$
- 6) Allow the trace to stabilize. Any emissions identified during the sweeps above and that fall within the 6 dB range below the applicable limit or above, shall be individually measured using RMS detector and compared to the limits.
- 7) For radiated method, the applicable measurement procedures as described in the EN 300 328 V2.2.2 annex C.2 and C.4 are used.

Any report having not been signed by authorized approver, or having been altered without authorization, or having not been stamped by the "Dedicated Testing/Inspection Stamp" is deemed to be invalid. Copying or excerpting portion of, or altering the content of the report is not permitted without the written authorization of AGC. The test results presented in the report apply only to the tested sample. Any objections to report issued by AGC should be submitted to AGC within 15 days after the issuance of the test report. Further enquiry of validity or verification of the test report should be addressed to AGC by [agc01@agccert.com](mailto:agc01@agccert.com).

### 5.6.3 TEST CONFIGURATION

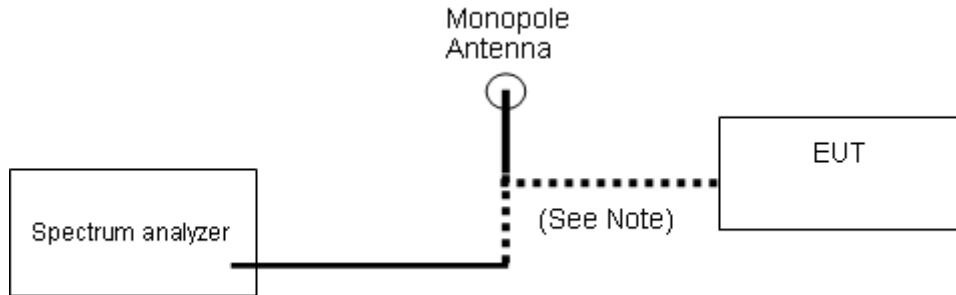

### Conducted Method

#### Below 1GHz

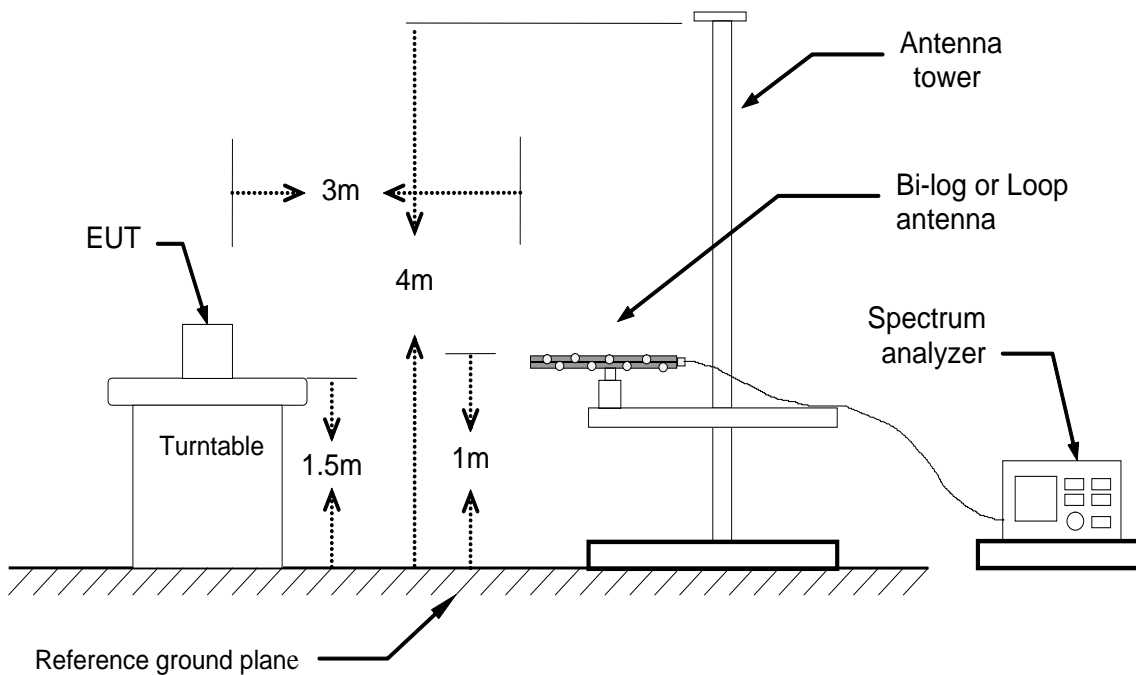

Any report having not been signed by authorized approver, or having been altered without authorization, or having not been stamped by the "Dedicated Testing/Inspection Stamp" is deemed to be invalid. Copying or excerpting portion of, or altering the content of the report is not permitted without the written authorization of AGC. The test results presented in the report apply only to the tested sample. Any objections to report issued by AGC should be submitted to AGC within 15days after the issuance of the test report. Further enquiry of validity or verification of the test report should be addressed to AGC by [agc01@agccert.com](mailto:agc01@agccert.com).

**Above 1GHz**

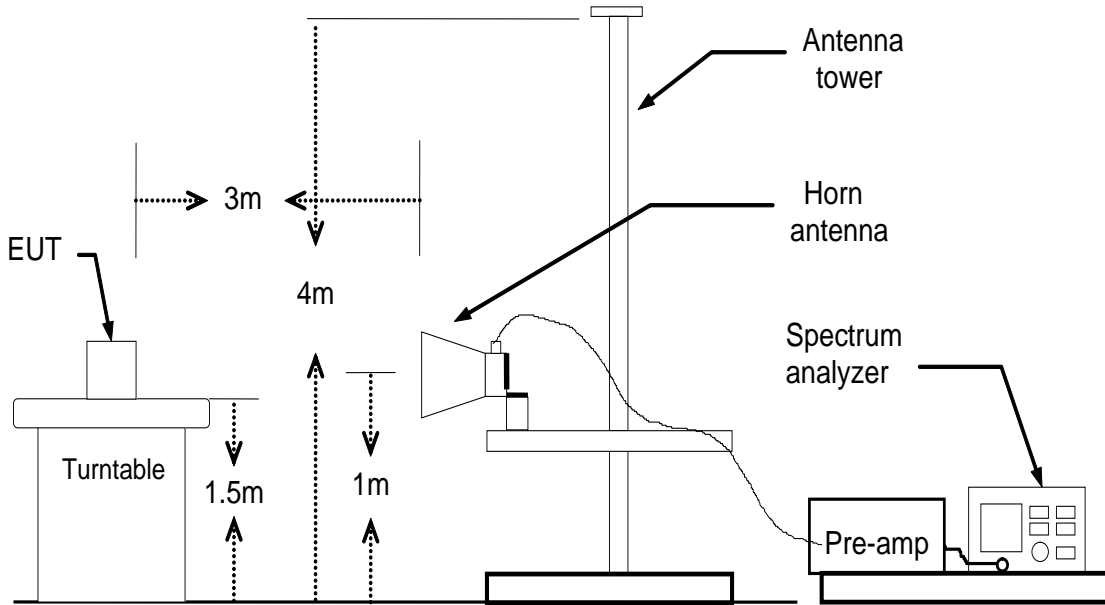

**Radiated Method**

Any report having not been signed by authorized approver, or having been altered without authorization, or having not been stamped by the “Dedicated Testing/Inspection Stamp” is deemed to be invalid. Copying or excerpting portion of, or altering the content of the report is not permitted without the written authorization of AGC. The test results presented in the report apply only to the tested sample. Any objections to report issued by AGC should be submitted to AGC within 15days after the issuance of the test report. Further enquiry of validity or verification of the test report should be addressed to AGC by agc01@agccert.com.

### 5.6.4 TEST RESULT

Test Data of Transmitter Spurious Emissions (Conducted Method)					
Test Mode	Detector	Frequency [MHz]	Level [dBm]	Limit [dBm]	Verdict
LE1M_TX_2402_1Mbps	Peak	4804.385	-35.70	-30.00	Pass
	Average	4804.385	-40.17	-30.00	Pass
LE1M_TX_2480_1Mbps	Peak	4959.882	-35.36	-30.00	Pass
	Average	4959.882	-39.05	-30.00	Pass
LE2M_TX_2402_2Mbps	Peak	862.805	-69.66	-36.00	Pass
	Peak	4805.560	-36.52	-30.00	Pass
LE2M_TX_2480_2Mbps	Peak	881.462	-69.81	-36.00	Pass
	Peak	4959.099	-36.06	-30.00	Pass

### Test Graphs of Transmitter Spurious Emissions (Conducted Method)

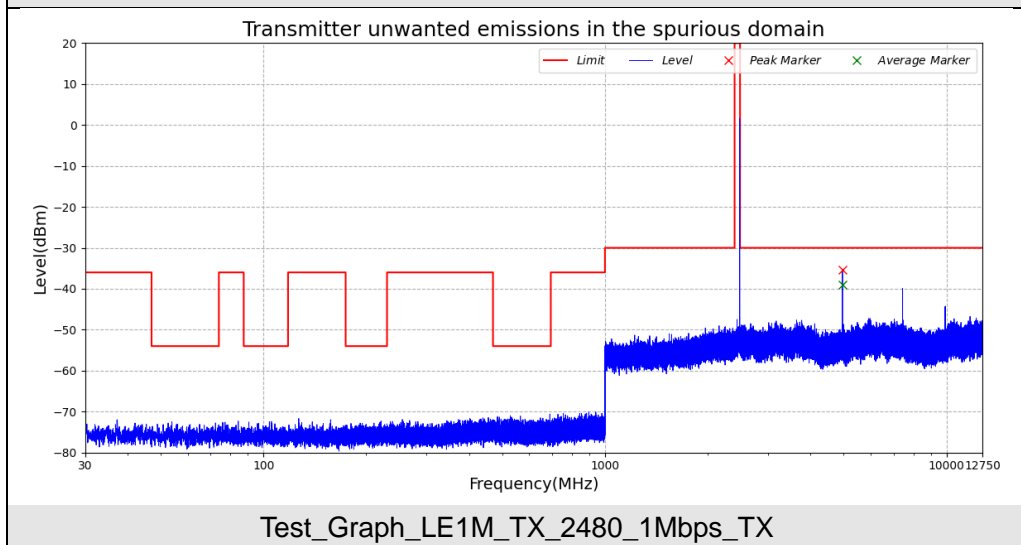
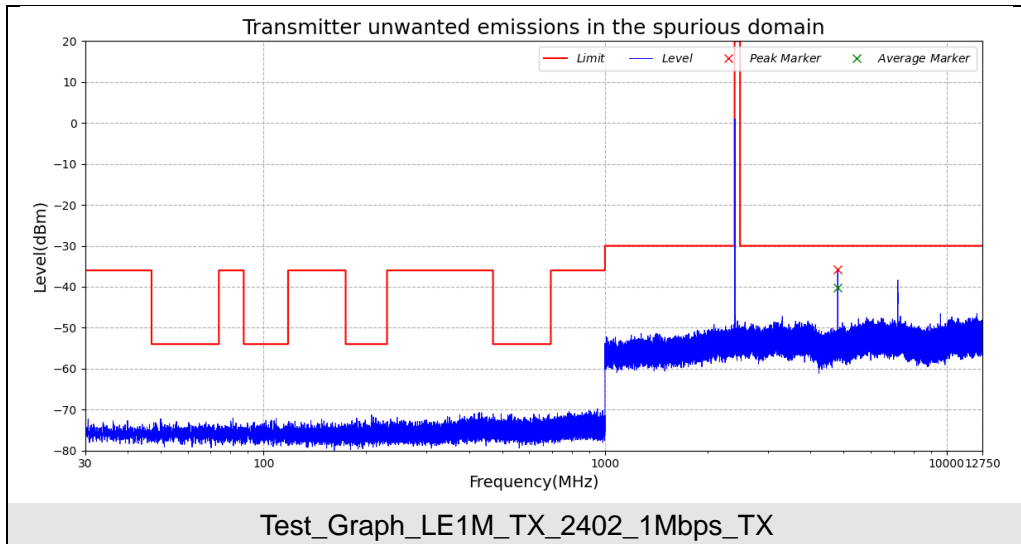

Any report having not been signed by authorized approver, or having been altered without authorization, or having not been stamped by the "Dedicated Testing/Inspection Stamp" is deemed to be invalid. Copying or excerpting portion of, or altering the content of the report is not permitted without the written authorization of AGC. The test results presented in the report apply only to the tested sample. Any objections to report issued by AGC should be submitted to AGC within 15 days after the issuance of the test report. Further enquiry of validity or verification of the test report should be addressed to AGC by agc01@agccert.com.



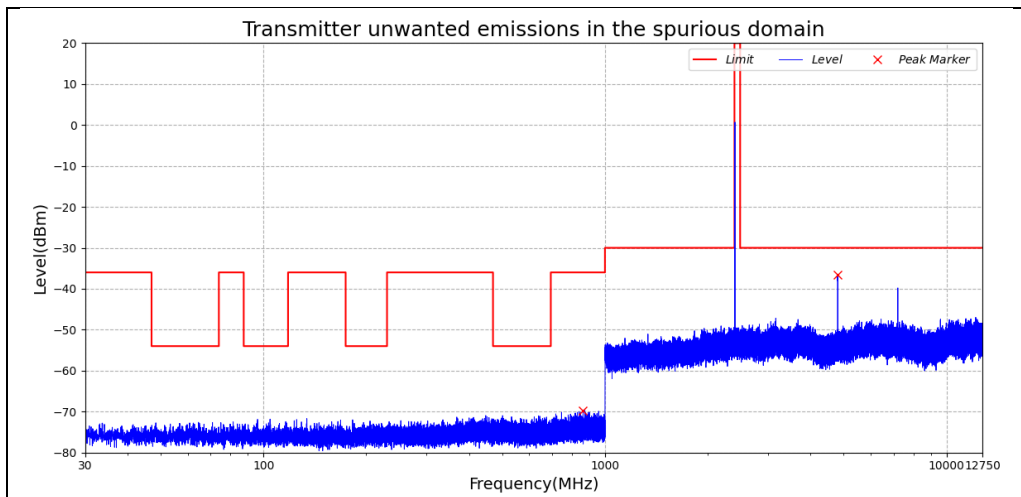

Test\_Graph\_LE2M\_TX\_2402\_2Mbps\_TX

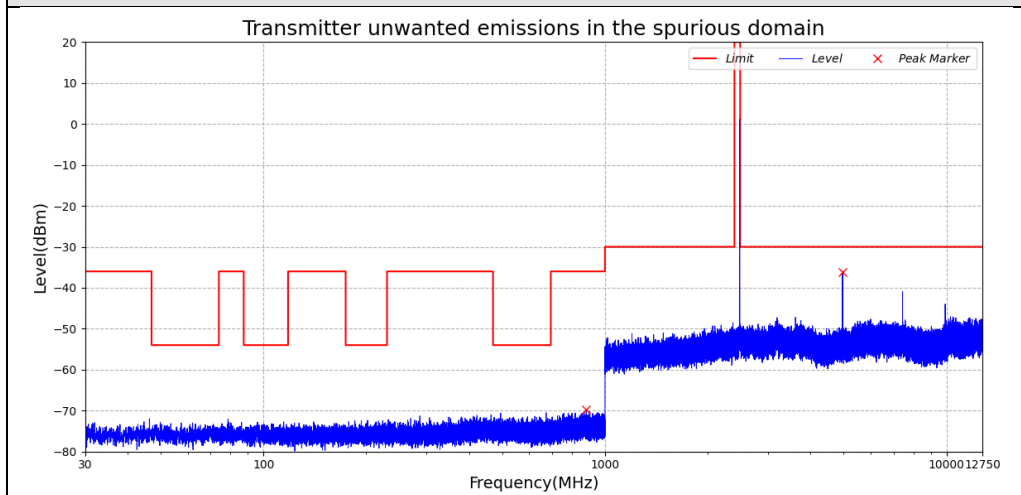

Test\_Graph\_LE2M\_TX\_2480\_2Mbps\_TX

Any report having not been signed by authorized approver, or having been altered without authorization, or having not been stamped by the "Dedicated Testing/Inspection Stamp" is deemed to be invalid. Copying or excerpting portion of, or altering the content of the report is not permitted without the written authorization of AGC. The test results presented in the report apply only to the tested sample. Any objections to report issued by AGC should be submitted to AGC within 15days after the issuance of the test report. Further enquiry of validity or verification of the test report should be addressed to AGC by agc01@agccert.com.

**Radiated Method: BLE 1Mbps**

**(Worst Case: Low channel)**

Transmitter Spurious Emission below 1GHz (30MHz-1GHz)

Frequency	Reading Level	Antenna	S.G.	Cable Loss	Ant.Gain	Emission Level	Limit	Margin
(MHz)	(dBuV/m)	Polarization	(dBm)	(dB)	(dBi)	(dBm)	(dBm)	(dB)
74.82	29.23	V	-62.50	0.03	-1.26	-63.79	-36.00	27.79
237.54	29.54	V	-69.70	0.11	6.60	-63.22	-36.00	27.22
382.14	27.66	V	-71.04	0.28	6.48	-64.84	-36.00	28.84
384.95	29.65	V	-69.84	0.28	6.46	-63.67	-36.00	27.67
425.49	26.50	V	-74.32	0.33	7.00	-67.65	-36.00	31.65
831.18	31.40	V	-68.36	0.66	6.37	-62.65	-36.00	26.65
Other(30-1000)	--	V	--	--	--	--	-36.00/-54.00	--
139.62	31.61	H	-61.66	0.05	0.00	-61.71	-36.00	25.71
338.26	32.79	H	-66.61	0.23	5.78	-61.06	-36.00	25.06
397.44	29.95	H	-69.24	0.30	6.54	-63.00	-36.00	27.00
458.02	29.03	H	-71.42	0.37	6.64	-65.15	-36.00	29.15
612.89	31.16	H	-68.64	0.50	6.58	-62.56	-54.00	8.56
767.31	30.94	H	-67.48	0.62	6.81	-61.28	-36.00	25.28
Other(30-1000)	--	H	--	--	--	--	-36.00/-54.00	--

Any report having not been signed by authorized approver, or having been altered without authorization, or having not been stamped by the "Dedicated Testing/Inspection Stamp" is deemed to be invalid. Copying or excerpting portion of, or altering the content of the report is not permitted without the written authorization of AGC. The test results presented in the report apply only to the tested sample. Any objections to report issued by AGC should be submitted to AGC within 15days after the issuance of the test report. Further enquiry of validity or verification of the test report should be addressed to AGC by agc01@agccert.com.

Transmitter Spurious Emission above 1GHz (1GHz-12.75GHz)

Frequency	Reading Level	Antenna	S.G.	Cable Loss	Ant.Gain	Emission Level	Limit	Margin
(MHz)	(dBuV/m)	Polarization	(dBm)	(dB)	(dBi)	(dBm)	(dBm)	(dB)
4804	52.01	V	-40.72	2.64	9.30	-34.05	-30.00	4.05
7206	46.70	V	-45.29	3.14	11.28	-37.14	-30.00	7.14
--	--	V	--	--	--	--	--	--
--	--	V	--	--	--	--	--	--
--	--	V	--	--	--	--	--	--
Other(1000-12750)	--	V	--	--	--	--	-30.00	--
4804	51.32	H	-41.15	2.64	9.30	-34.49	-30.00	4.49
7206	44.41	H	-45.10	3.14	11.28	-36.96	-30.00	6.96
--	--	H	--	--	--	--	--	--
--	--	H	--	--	--	--	--	--
--	--	H	--	--	--	--	--	--
Other(1000-12750)	--	H	--	--	--	--	-30.00	--

Note: 1. The margins of the other spectrum are not exceeding the minimum value of margin, and this part of the results without recording in the test report.  
2. Measurements above show only up to 6 maximum emissions noted, or would be lesser, with "--" remark, if no specific emission from the EUT are recorded (ie: margin>20dB from the applicable limit) and considered that's already beyond the background noise floor.

Any report having not been signed by authorized approver, or having been altered without authorization, or having not been stamped by the "Dedicated Testing/Inspection Stamp" is deemed to be invalid. Copying or excerpting portion of, or altering the content of the report is not permitted without the written authorization of AGC. The test results presented in the report apply only to the tested sample. Any objections to report issued by AGC should be submitted to AGC within 15days after the issuance of the test report. Further enquiry of validity or verification of the test report should be addressed to AGC by agc01@agccert.com.

**(Worst Case: High channel)**

Transmitter Spurious Emission below 1GHz (30MHz-1GHz)

Frequency	Reading Level	Antenna	S.G.	Cable Loss	Ant.Gain	Emission Level	Limit	Margin
(MHz)	(dBuV/m)	Polarization	(dBm)	(dB)	(dBi)	(dBm)	(dBm)	(dB)
77.43	28.42	V	-64.04	0.04	-0.70	-64.78	-36.00	28.78
234.67	30.05	V	-69.31	0.11	6.60	-62.81	-36.00	26.81
380.08	29.18	V	-70.54	0.28	6.50	-64.32	-36.00	28.32
384.78	28.73	V	-70.38	0.28	6.46	-64.21	-36.00	28.21
424.38	27.61	V	-72.90	0.33	7.02	-66.21	-36.00	30.21
828.30	31.59	V	-67.65	0.66	6.40	-61.91	-36.00	25.91
Other(30-1000)	--	V	--	--	--	--	-36.00/-54.00	--
137.38	31.12	H	-61.43	0.05	0.00	-61.48	-36.00	25.48
341.42	32.10	H	-66.18	0.23	5.68	-60.73	-36.00	24.73
396.31	28.59	H	-71.13	0.30	6.52	-64.91	-36.00	28.91
459.83	27.43	H	-71.60	0.37	6.67	-65.31	-36.00	29.31
612.82	30.34	H	-68.33	0.50	6.58	-62.25	-54.00	8.25
764.62	31.30	H	-67.18	0.61	6.72	-61.07	-36.00	25.07
Other(30-1000)	--	H	--	--	--	--	-36.00/-54.00	--

Any report having not been signed by authorized approver, or having been altered without authorization, or having not been stamped by the "Dedicated Testing/Inspection Stamp" is deemed to be invalid. Copying or excerpting portion of, or altering the content of the report is not permitted without the written authorization of AGC. The test results presented in the report apply only to the tested sample. Any objections to report issued by AGC should be submitted to AGC within 15days after the issuance of the test report. Further enquiry of validity or verification of the test report should be addressed to AGC by agc01@agccert.com.

Transmitter Spurious Emission above 1GHz (1GHz-12.75GHz)

Frequency	Reading Level	Antenna	S.G.	Cable Loss	Ant.Gain	Emission Level	Limit	Margin
(MHz)	(dBuV/m)	Polarization	(dBm)	(dB)	(dBi)	(dBm)	(dBm)	(dB)
4960	51.83	V	-42.09	2.75	9.62	-35.22	-30.00	5.22
7440	47.22	V	-49.09	3.09	11.62	-40.56	-30.00	10.56
--	--	V	--	--	--	--	--	--
--	--	V	--	--	--	--	--	--
--	--	V	--	--	--	--	--	--
Other(1000-12750)	--	V	--	--	--	--	-30.00	--
4960	51.70	H	-43.24	2.75	9.62	-36.37	-30.00	6.37
7440	44.11	H	-49.58	3.09	11.62	-41.05	-30.00	11.05
--	--	H	--	--	--	--	--	--
--	--	H	--	--	--	--	--	--
--	--	H	--	--	--	--	--	--
Other(1000-12750)	--	H	--	--	--	--	-30.00	--

Note: 1. The margins of the other spectrum are not exceeding the minimum value of margin, and this part of the results without recording in the test report.

2. Measurements above show only up to 6 maximum emissions noted, or would be lesser, with "--" remark, if no specific emission from the EUT are recorded (ie: margin>20dB from the applicable limit) and considered that's already beyond the background noise floor.

**Radiated Method: BLE 2Mbps**

**(Worst Case: Low channel)**

Transmitter Spurious Emission below 1GHz (30MHz-1GHz)

Frequency	Reading Level	Antenna	S.G.	Cable Loss	Ant.Gain	Emission Level	Limit	Margin
(MHz)	(dBuV/m)	Polarization	(dBm)	(dB)	(dBi)	(dBm)	(dBm)	(dB)
75.75	29.35	V	-62.41	0.03	-1.10	-63.54	-36.00	27.54
238.53	29.87	V	-70.21	0.11	6.60	-63.73	-36.00	27.73
382.87	29.27	V	-69.65	0.28	6.48	-63.45	-36.00	27.45
387.42	30.35	V	-69.30	0.29	6.43	-63.16	-36.00	27.16
423.33	27.98	V	-70.99	0.33	7.04	-64.28	-36.00	28.28
830.84	29.87	V	-69.23	0.66	6.30	-63.59	-36.00	27.59
Other(30-1000)	--	V	--	--	--	--	-36.00/-54.00	--
140.78	31.70	H	-61.28	0.05	0.00	-61.33	-36.00	25.33
338.27	31.71	H	-67.17	0.23	5.78	-61.62	-36.00	25.62
396.40	30.31	H	-69.78	0.30	6.52	-63.56	-36.00	27.56
459.17	27.56	H	-71.54	0.37	6.67	-65.24	-36.00	29.24
613.28	31.34	H	-67.22	0.50	6.62	-61.11	-54.00	7.11
765.27	30.61	H	-69.05	0.61	6.75	-62.91	-36.00	26.91
Other(30-1000)	--	H	--	--	--	--	-36.00/-54.00	--

Any report having not been signed by authorized approver, or having been altered without authorization, or having not been stamped by the "Dedicated Testing/Inspection Stamp" is deemed to be invalid. Copying or excerpting portion of, or altering the content of the report is not permitted without the written authorization of AGC. The test results presented in the report apply only to the tested sample. Any objections to report issued by AGC should be submitted to AGC within 15days after the issuance of the test report. Further enquiry of validity or verification of the test report should be addressed to AGC by agc01@agccert.com.

Transmitter Spurious Emission above 1GHz (1GHz-12.75GHz)

Frequency	Reading Level	Antenna	S.G.	Cable Loss	Ant.Gain	Emission Level	Limit	Margin
(MHz)	(dBuV/m)	Polarization	(dBm)	(dB)	(dBi)	(dBm)	(dBm)	(dB)
4804	52.01	V	-41.34	2.64	9.30	-34.67	-30.00	4.67
7206	46.70	V	-44.39	3.14	11.28	-36.25	-30.00	6.25
--	--	V	--	--	--	--	--	--
--	--	V	--	--	--	--	--	--
--	--	V	--	--	--	--	--	--
Other(1000-12750)	--	V	--	--	--	--	-30.00	--
4804	51.32	H	-40.62	2.64	9.30	-33.96	-30.00	3.96
7206	44.41	H	-46.15	3.14	11.28	-38.01	-30.00	8.01
--	--	H	--	--	--	--	--	--
--	--	H	--	--	--	--	--	--
--	--	H	--	--	--	--	--	--
Other(1000-12750)	--	H	--	--	--	--	-30.00	--

Note: 1. The margins of the other spectrum are not exceeding the minimum value of margin, and this part of the results without recording in the test report.  
 2. Measurements above show only up to 6 maximum emissions noted, or would be lesser, with "--" remark, if no specific emission from the EUT are recorded (ie: margin>20dB from the applicable limit) and considered that's already beyond the background noise floor.

Any report having not been signed by authorized approver, or having been altered without authorization, or having not been stamped by the "Dedicated Testing/Inspection Stamp" is deemed to be invalid. Copying or excerpting portion of, or altering the content of the report is not permitted without the written authorization of AGC. The test results presented in the report apply only to the tested sample. Any objections to report issued by AGC should be submitted to AGC within 15days after the issuance of the test report. Further enquiry of validity or verification of the test report should be addressed to AGC by agc01@agccert.com.

**(Worst Case: High channel)**

Transmitter Spurious Emission below 1GHz (30MHz-1GHz)

Frequency	Reading Level	Antenna	S.G.	Cable Loss	Ant.Gain	Emission Level	Limit	Margin
(MHz)	(dBuV/m)	Polarization	(dBm)	(dB)	(dBi)	(dBm)	(dBm)	(dB)
79.08	28.81	V	-63.91	0.04	-0.30	-64.25	-36.00	28.25
237.85	29.51	V	-70.30	0.11	6.60	-63.81	-36.00	27.81
381.42	27.88	V	-72.15	0.28	6.49	-65.94	-36.00	29.94
387.08	28.85	V	-71.18	0.29	6.43	-65.03	-36.00	29.03
424.10	27.09	V	-73.50	0.33	7.02	-66.81	-36.00	30.81
828.25	31.44	V	-66.99	0.66	6.40	-61.25	-36.00	25.25
Other(30-1000)	--	V	--	--	--	--	-36.00/-54.00	--
138.73	30.89	H	-61.68	0.05	0.00	-61.73	-36.00	25.73
339.23	31.77	H	-66.42	0.23	5.74	-60.91	-36.00	24.91
395.03	29.16	H	-71.20	0.30	6.50	-65.00	-36.00	29.00
457.68	27.89	H	-72.52	0.37	6.61	-66.28	-36.00	30.28
613.91	30.46	H	-69.03	0.50	6.62	-62.92	-54.00	8.92
768.49	30.31	H	-69.97	0.62	6.84	-63.74	-36.00	27.74
Other(30-1000)	--	H	--	--	--	--	-36.00/-54.00	--

Any report having not been signed by authorized approver, or having been altered without authorization, or having not been stamped by the "Dedicated Testing/Inspection Stamp" is deemed to be invalid. Copying or excerpting portion of, or altering the content of the report is not permitted without the written authorization of AGC. The test results presented in the report apply only to the tested sample. Any objections to report issued by AGC should be submitted to AGC within 15days after the issuance of the test report. Further enquiry of validity or verification of the test report should be addressed to AGC by agc01@agccert.com.



Transmitter Spurious Emission above 1GHz (1GHz-12.75GHz)

Frequency	Reading Level	Antenna	S.G.	Cable Loss	Ant.Gain	Emission Level	Limit	Margin
(MHz)	(dBuV/m)	Polarization	(dBm)	(dB)	(dBi)	(dBm)	(dBm)	(dB)
4960	51.83	V	-41.36	2.75	9.62	-34.49	-30.00	4.49
7440	47.22	V	-49.23	3.09	11.62	-40.70	-30.00	10.70
--	--	V	--	--	--	--	--	--
--	--	V	--	--	--	--	--	--
--	--	V	--	--	--	--	--	--
Other(1000-12750)	--	V	--	--	--	--	-30.00	--
4960	51.70	H	-42.13	2.75	9.62	-35.26	-30.00	5.26
7440	44.11	H	-49.28	3.09	11.62	-40.75	-30.00	10.75
--	--	H	--	--	--	--	--	--
--	--	H	--	--	--	--	--	--
--	--	H	--	--	--	--	--	--
Other(1000-12750)	--	H	--	--	--	--	-30.00	--

Note: 1. The margins of the other spectrum are not exceeding the minimum value of margin, and this part of the results without recording in the test report.

2. Measurements above show only up to 6 maximum emissions noted, or would be lesser, with "--" remark, if no specific emission from the EUT are recorded (ie: margin>20dB from the applicable limit) and considered that's already beyond the background noise floor.

Any report having not been signed by authorized approver, or having been altered without authorization, or having not been stamped by the "Dedicated Testing/Inspection Stamp" is deemed to be invalid. Copying or excerpting portion of, or altering the content of the report is not permitted without the written authorization of AGC. The test results presented in the report apply only to the tested sample. Any objections to report issued by AGC should be submitted to AGC within 15days after the issuance of the test report. Further enquiry of validity or verification of the test report should be addressed to AGC by agc01@agccert.com.

## 5.7. RECEIVER UNWANTED EMISSIONS IN THE SPURIOUS DOMAIN

### 5.7.1 LIMIT

Receiver spurious emissions are emissions at any frequency when the equipment is in receive mode.

The spurious emissions of the receiver shall not exceed the values given in table.

Frequency Range	Maximum Power e.r.p(<=1GHz)/e.i.r.p(>1GHz)	Measurement Bandwidth
30 MHz to 1000 MHz	-57dBm	100kHz
1 GHz to 12.75 GHz	-47dBm	1MHz

### 5.7.2 TEST PROCEDURE

- 1) The emissions over the range 30 MHz to 1 000 MHz shall be identified.
- 2) Spectrum analyzer settings:  
Resolution bandwidth: 100 kHz  
Video bandwidth: 300 kHz  
Detector mode: Peak  
Sweep Points:  $\geq 19\ 400$   
Trace Mode: Max Hold
- 3) Allow the trace to stabilize. Any emissions identified during the sweeps above and that fall within the 6 dB range below the applicable limit or above, shall be individually measured using RMS detector and compared to the limits given in 5.7.1.
- 4) The emissions over the range 1 GHz to 12.75 GHz shall be identified.
- 5) Resolution bandwidth: 1 MHz  
Video bandwidth: 3 MHz  
Detector mode: Peak  
Trace Mode: Max Hold  
Sweep Points:  $\geq 23\ 200$
- 6) Allow the trace to stabilize. Any emissions identified during the sweeps above and that fall within the 6 dB range below the applicable limit or above, shall be individually measured using RMS detector and compared to the limits given in 5.7.1.
- 7) For radiated method, the applicable measurement procedures as described in the EN 300 328 V2.2.2 annex C.2 and C.4 are used.

### 5.7.3 TEST CONFIGURATION

Refer to 5.6.3

### 5.7.4 TEST RESULT

Test Data of Receiver Spurious Emissions (Conducted Method)					
Test Mode	Detector	Frequency [MHz]	Level [dBm]	Limit [dBm]	Verdict
LE1M_RX_2402_1Mbps	Peak	96.027	-78.17	-57.00	Pass
	Peak	2426.498	-66.80	-47.00	Pass
LE1M_RX_2480_1Mbps	Peak	95.962	-78.49	-57.00	Pass
	Peak	3321.877	-66.75	-47.00	Pass
LE2M_RX_2402_2Mbps	Peak	96.027	-78.27	-57.00	Pass
	Peak	12266.276	-66.76	-47.00	Pass
LE2M_RX_2480_2Mbps	Peak	96.027	-79.56	-57.00	Pass
	Peak	10482.566	-67.02	-47.00	Pass

### Test Graphs of Receiver Spurious Emissions (Conducted Method)

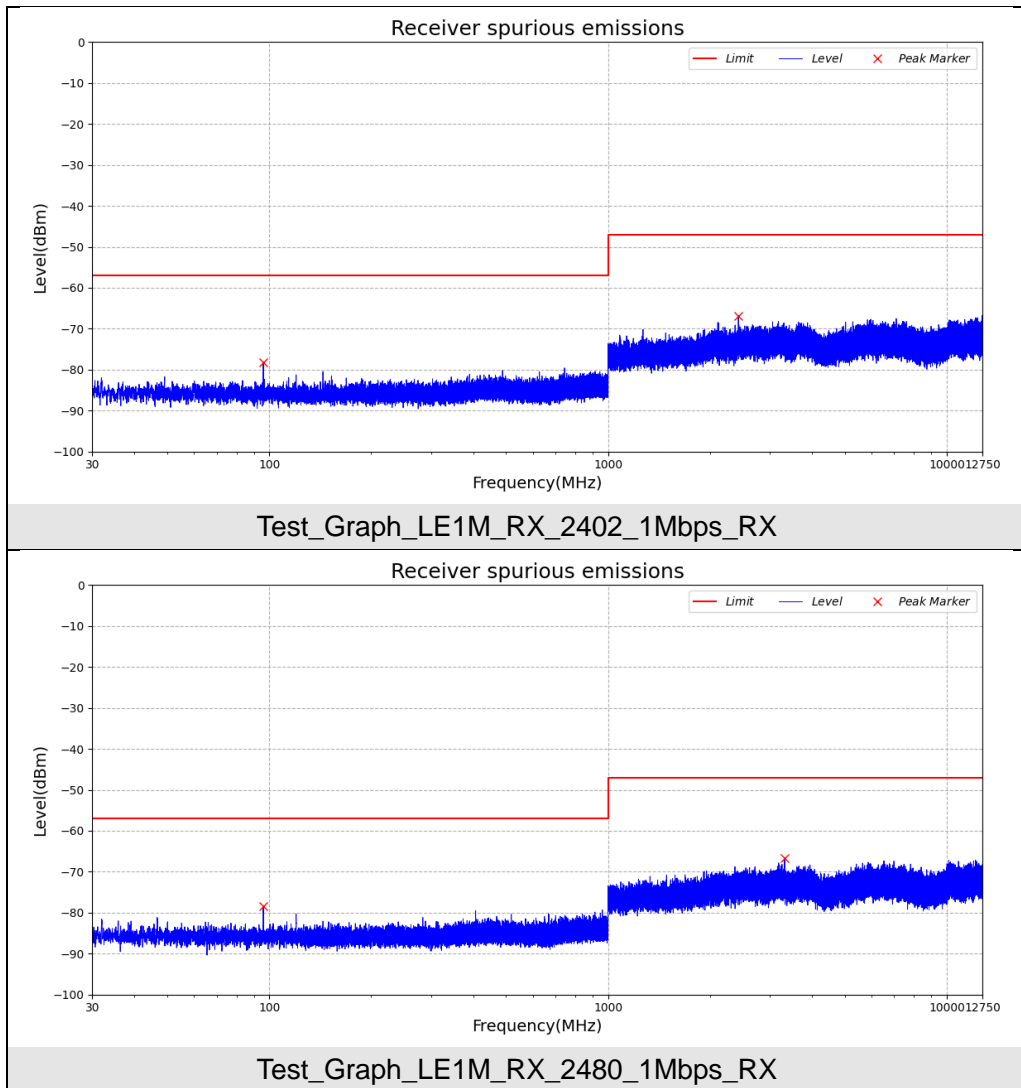

Any report having not been signed by authorized approver, or having been altered without authorization, or having not been stamped by the "Dedicated Testing/Inspection Stamp" is deemed to be invalid. Copying or excerpting portion of, or altering the content of the report is not permitted without the written authorization of AGC. The test results presented in the report apply only to the tested sample. Any objections to report issued by AGC should be submitted to AGC within 15days after the issuance of the test report. Further enquiry of validity or verification of the test report should be addressed to AGC by agc01@agccert.com.

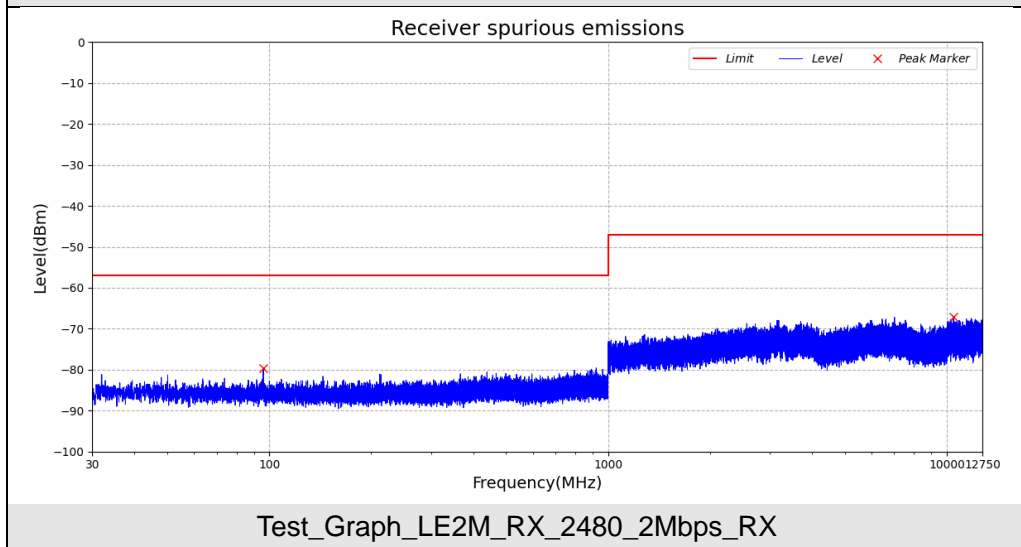
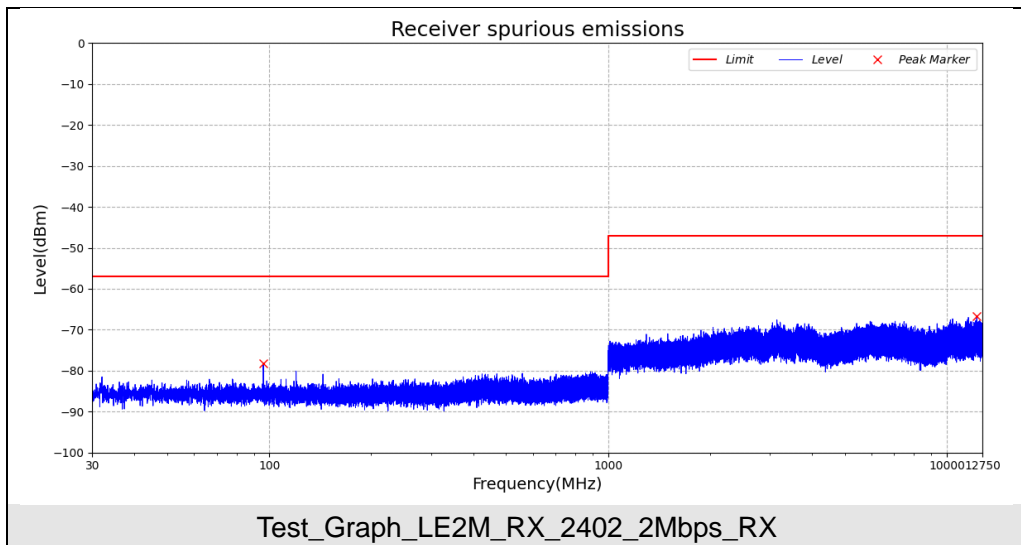

Any report having not been signed by authorized approver, or having been altered without authorization, or having not been stamped by the "Dedicated Testing/Inspection Stamp" is deemed to be invalid. Copying or excerpting portion of, or altering the content of the report is not permitted without the written authorization of AGC. The test results presented in the report apply only to the tested sample. Any objections to report issued by AGC should be submitted to AGC within 15days after the issuance of the test report. Further enquiry of validity or verification of the test report should be addressed to AGC by agc01@agccert.com.

**Radiated Method: BLE 1Mbps**

**(Worst Case: Low channel)**

Receiver Spurious Emission below 1GHz (30MHz-1GHz)

Frequency	Reading Level	Antenna	S.G.	Cable Loss	Ant.Gain	Emission Level	Limit	Margin
(MHz)	(dBuV/m)	Polarization	(dBm)	(dB)	(dBi)	(dBm)	(dBm)	(dB)
91.61	28.35	V	-66.70	0.04	1.48	-65.26	-57.00	8.26
241.36	30.07	V	-70.62	0.12	6.66	-64.08	-57.00	7.08
315.18	27.87	V	-71.93	0.20	6.25	-65.89	-57.00	8.89
384.90	28.86	V	-69.61	0.28	6.46	-63.43	-57.00	6.43
476.41	28.01	V	-71.69	0.39	6.86	-65.23	-57.00	8.23
827.49	31.59	V	-66.48	0.66	6.45	-60.68	-57.00	3.68
Other(30-1000)	--	V	--	--	--	--	-57.00	--
140.80	29.00	H	-63.73	0.05	0.00	-63.78	-57.00	6.78
332.24	29.78	H	-68.52	0.22	6.02	-62.73	-57.00	5.73
395.49	30.41	H	-69.50	0.30	6.50	-63.30	-57.00	6.30
568.45	29.09	H	-70.83	0.47	6.82	-64.48	-57.00	7.48
613.07	28.61	H	-71.39	0.50	6.62	-65.27	-57.00	8.27
815.60	29.16	H	-70.81	0.65	6.95	-64.51	-57.00	7.51
Other(30-1000)	--	H	--	--	--	--	-57.00	--

Any report having not been signed by authorized approver, or having been altered without authorization, or having not been stamped by the "Dedicated Testing/Inspection Stamp" is deemed to be invalid. Copying or excerpting portion of, or altering the content of the report is not permitted without the written authorization of AGC. The test results presented in the report apply only to the tested sample. Any objections to report issued by AGC should be submitted to AGC within 15days after the issuance of the test report. Further enquiry of validity or verification of the test report should be addressed to AGC by agc01@agccert.com.

Receiver Spurious Emission above 1GHz (1GHz-12.75GHz)

Frequency	Reading Level	Antenna	S.G.	Cable Loss	Ant.Gain	Emission Level	Limit	Margin
(MHz)	(dBuV/m)	Polarization	(dBm)	(dB)	(dBi)	(dBm)	(dBm)	(dB)
1837.29	31.97	V	-67.54	1.26	7.15	-61.65	-47.00	14.65
--	--	V	--	--	--	--	--	--
--	--	V	--	--	--	--	--	--
--	--	V	--	--	--	--	--	--
--	--	V	--	--	--	--	--	--
Other(1000-12750)	--	V	--	--	--	--	-47.00	--
1779.03	30.66	H	-67.69	1.22	6.89	-62.02	-47.00	15.02
--	--	H	--	--	--	--	--	--
--	--	H	--	--	--	--	--	--
--	--	H	--	--	--	--	--	--
--	--	H	--	--	--	--	--	--
Other(1000-12750)	--	H	--	--	--	--	-47.00	--

Note: 1. The margins of the other spectrum are not exceeding the minimum value of margin, and this part of the results without recording in the test report.  
2. Measurements above show only up to 6 maximum emissions noted, or would be lesser, with "--" remark, if no specific emission from the EUT are recorded (ie: margin>20dB from the applicable limit) and considered that's already beyond the background noise floor.

Any report having not been signed by authorized approver, or having been altered without authorization, or having not been stamped by the "Dedicated Testing/Inspection Stamp" is deemed to be invalid. Copying or excerpting portion of, or altering the content of the report is not permitted without the written authorization of AGC. The test results presented in the report apply only to the tested sample. Any objections to report issued by AGC should be submitted to AGC within 15days after the issuance of the test report. Further enquiry of validity or verification of the test report should be addressed to AGC by agc01@agccert.com.

**(Worst Case: High channel)**

Receiver Spurious Emission below 1GHz (30MHz-1GHz)

Frequency	Reading Level	Antenna	S.G.	Cable Loss	Ant.Gain	Emission Level	Limit	Margin
(MHz)	(dBuV/m)	Polarization	(dBm)	(dB)	(dBi)	(dBm)	(dBm)	(dB)
92.85	28.02	V	-66.56	0.04	1.56	-65.04	-57.00	8.04
238.87	31.00	V	-68.64	0.11	6.60	-62.16	-57.00	5.16
316.60	28.66	V	-70.32	0.21	6.22	-64.30	-57.00	7.30
386.52	30.08	V	-68.84	0.29	6.44	-62.69	-57.00	5.69
475.47	29.20	V	-69.62	0.39	6.85	-63.16	-57.00	6.16
829.80	29.81	V	-69.41	0.66	6.35	-63.72	-57.00	6.72
Other(30-1000)	--	V	--	--	--	--	-57.00	--
139.36	28.69	H	-63.58	0.05	0.00	-63.63	-57.00	6.63
333.64	28.70	H	-70.12	0.23	5.98	-64.37	-57.00	7.37
396.37	31.03	H	-67.42	0.30	6.52	-61.20	-57.00	4.20
567.78	30.08	H	-69.37	0.47	6.83	-63.01	-57.00	6.01
616.38	27.90	H	-70.62	0.51	6.74	-64.38	-57.00	7.38
819.32	29.14	H	-70.52	0.65	6.83	-64.34	-57.00	7.34
Other(30-1000)	--	H	--	--	--	--	-57.00	--

Any report having not been signed by authorized approver, or having been altered without authorization, or having not been stamped by the "Dedicated Testing/Inspection Stamp" is deemed to be invalid. Copying or excerpting portion of, or altering the content of the report is not permitted without the written authorization of AGC. The test results presented in the report apply only to the tested sample. Any objections to report issued by AGC should be submitted to AGC within 15days after the issuance of the test report. Further enquiry of validity or verification of the test report should be addressed to AGC by agc01@agccert.com.

Receiver Spurious Emission above 1GHz (1GHz-12.75GHz)

Frequency	Reading Level	Antenna	S.G.	Cable Loss	Ant.Gain	Emission Level	Limit	Margin
(MHz)	(dBuV/m)	Polarization	(dBm)	(dB)	(dBi)	(dBm)	(dBm)	(dB)
1836.95	31.41	V	-67.80	1.26	7.15	-61.90	-47.00	14.90
--	--	V	--	--	--	--	--	--
--	--	V	--	--	--	--	--	--
--	--	V	--	--	--	--	--	--
--	--	V	--	--	--	--	--	--
Other(1000-12750)	--	V	--	--	--	--	-47.00	--
1779.62	31.28	H	-66.81	1.22	6.89	-61.14	-47.00	14.14
--	--	H	--	--	--	--	--	--
--	--	H	--	--	--	--	--	--
--	--	H	--	--	--	--	--	--
--	--	H	--	--	--	--	--	--
Other(1000-12750)	--	H	--	--	--	--	-47.00	--

Note: 1. The margins of the other spectrum are not exceeding the minimum value of margin, and this part of the results without recording in the test report.  
2. Measurements above show only up to 6 maximum emissions noted, or would be lesser, with "--" remark, if no specific emission from the EUT are recorded (ie: margin>20dB from the applicable limit) and considered that's already beyond the background noise floor.

Any report having not been signed by authorized approver, or having been altered without authorization, or having not been stamped by the "Dedicated Testing/Inspection Stamp" is deemed to be invalid. Copying or excerpting portion of, or altering the content of the report is not permitted without the written authorization of AGC. The test results presented in the report apply only to the tested sample. Any objections to report issued by AGC should be submitted to AGC within 15days after the issuance of the test report. Further enquiry of validity or verification of the test report should be addressed to AGC by agc01@agccert.com.



**Radiated Method: BLE 2Mbps**

**(Worst Case: Low channel)**

Receiver Spurious Emission below 1GHz (30MHz-1GHz)

Frequency	Reading Level	Antenna	S.G.	Cable Loss	Ant.Gain	Emission Level	Limit	Margin
(MHz)	(dBuV/m)	Polarization	(dBm)	(dB)	(dBi)	(dBm)	(dBm)	(dB)
93.39	29.40	V	-65.23	0.04	1.64	-63.63	-57.00	6.63
240.80	30.14	V	-69.37	0.12	6.60	-62.89	-57.00	5.89
312.61	28.02	V	-70.38	0.20	6.34	-64.24	-57.00	7.24
385.14	29.33	V	-69.29	0.29	6.45	-63.12	-57.00	6.12
476.58	28.84	V	-69.97	0.39	6.86	-63.50	-57.00	6.50
827.97	31.03	V	-68.18	0.66	6.45	-62.39	-57.00	5.39
Other(30-1000)	--	V	--	--	--	--	-57.00	--
137.20	29.06	H	-63.33	0.05	0.00	-63.38	-57.00	6.38
332.63	28.65	H	-69.96	0.22	6.02	-64.16	-57.00	7.16
396.12	29.66	H	-69.98	0.30	6.52	-63.76	-57.00	6.76
569.75	29.19	H	-70.35	0.47	6.81	-64.01	-57.00	7.01
614.72	28.72	H	-70.09	0.50	6.66	-63.93	-57.00	6.93
819.79	28.51	H	-70.67	0.65	6.83	-64.49	-57.00	7.49
Other(30-1000)	--	H	--	--	--	--	-57.00	--

Any report having not been signed by authorized approver, or having been altered without authorization, or having not been stamped by the "Dedicated Testing/Inspection Stamp" is deemed to be invalid. Copying or excerpting portion of, or altering the content of the report is not permitted without the written authorization of AGC. The test results presented in the report apply only to the tested sample. Any objections to report issued by AGC should be submitted to AGC within 15days after the issuance of the test report. Further enquiry of validity or verification of the test report should be addressed to AGC by agc01@agccert.com.

Receiver Spurious Emission above 1GHz (1GHz-12.75GHz)

Frequency	Reading Level	Antenna	S.G.	Cable Loss	Ant.Gain	Emission Level	Limit	Margin
(MHz)	(dBuV/m)	Polarization	(dBm)	(dB)	(dBi)	(dBm)	(dBm)	(dB)
1836.09	32.72	V	-66.00	1.26	7.15	-60.11	-47.00	13.11
--	--	V	--	--	--	--	--	--
--	--	V	--	--	--	--	--	--
--	--	V	--	--	--	--	--	--
--	--	V	--	--	--	--	--	--
Other(1000-12750)	--	V	--	--	--	--	-47.00	--
1782.95	31.30	H	-67.72	1.23	6.93	-62.02	-47.00	15.02
--	--	H	--	--	--	--	--	--
--	--	H	--	--	--	--	--	--
--	--	H	--	--	--	--	--	--
--	--	H	--	--	--	--	--	--
Other(1000-12750)	--	H	--	--	--	--	-47.00	--

Note: 1. The margins of the other spectrum are not exceeding the minimum value of margin, and this part of the results without recording in the test report.  
2. Measurements above show only up to 6 maximum emissions noted, or would be lesser, with "--" remark, if no specific emission from the EUT are recorded (ie: margin>20dB from the applicable limit) and considered that's already beyond the background noise floor.

Any report having not been signed by authorized approver, or having been altered without authorization, or having not been stamped by the "Dedicated Testing/Inspection Stamp" is deemed to be invalid. Copying or excerpting portion of, or altering the content of the report is not permitted without the written authorization of AGC. The test results presented in the report apply only to the tested sample. Any objections to report issued by AGC should be submitted to AGC within 15days after the issuance of the test report. Further enquiry of validity or verification of the test report should be addressed to AGC by agc01@agccert.com.

**(Worst Case: High channel)**

Receiver Spurious Emission below 1GHz (30MHz-1GHz)

Frequency	Reading Level	Antenna	S.G.	Cable Loss	Ant.Gain	Emission Level	Limit	Margin
(MHz)	(dBuV/m)	Polarization	(dBm)	(dB)	(dBi)	(dBm)	(dBm)	(dB)
93.72	29.71	V	-64.86	0.04	1.64	-63.26	-57.00	6.26
242.22	30.47	V	-68.93	0.12	6.72	-62.33	-57.00	5.33
316.68	27.47	V	-72.28	0.21	6.22	-66.26	-57.00	9.26
382.94	28.71	V	-71.10	0.28	6.48	-64.90	-57.00	7.90
476.07	27.62	V	-72.52	0.39	6.86	-66.06	-57.00	9.06
829.99	31.18	V	-67.29	0.66	6.35	-61.60	-57.00	4.60
Other(30-1000)	--	V	--	--	--	--	-57.00	--
139.19	29.53	H	-63.05	0.05	0.00	-63.10	-57.00	6.10
332.99	30.35	H	-69.57	0.22	6.02	-63.78	-57.00	6.78
397.03	29.93	H	-69.78	0.30	6.54	-63.54	-57.00	6.54
568.53	29.08	H	-69.70	0.47	6.82	-63.35	-57.00	6.35
617.12	28.00	H	-72.35	0.51	6.78	-66.08	-57.00	9.08
817.84	30.09	H	-68.43	0.65	6.89	-62.19	-57.00	5.19
Other(30-1000)	--	H	--	--	--	--	-57.00	--

Any report having not been signed by authorized approver, or having been altered without authorization, or having not been stamped by the "Dedicated Testing/Inspection Stamp" is deemed to be invalid. Copying or excerpting portion of, or altering the content of the report is not permitted without the written authorization of AGC. The test results presented in the report apply only to the tested sample. Any objections to report issued by AGC should be submitted to AGC within 15days after the issuance of the test report. Further enquiry of validity or verification of the test report should be addressed to AGC by agc01@agccert.com.

Receiver Spurious Emission above 1GHz (1GHz-12.75GHz)

Frequency	Reading Level	Antenna	S.G.	Cable Loss	Ant.Gain	Emission Level	Limit	Margin
(MHz)	(dBuV/m)	Polarization	(dBm)	(dB)	(dBi)	(dBm)	(dBm)	(dB)
1836.51	33.21	V	-66.14	1.26	7.15	-60.24	-47.00	13.24
--	--	V	--	--	--	--	--	--
--	--	V	--	--	--	--	--	--
--	--	V	--	--	--	--	--	--
--	--	V	--	--	--	--	--	--
Other(1000-12750)	--	V	--	--	--	--	-47.00	--
1784.98	31.53	H	-67.26	1.23	6.93	-61.56	-47.00	14.56
--	--	H	--	--	--	--	--	--
--	--	H	--	--	--	--	--	--
--	--	H	--	--	--	--	--	--
--	--	H	--	--	--	--	--	--
Other(1000-12750)	--	H	--	--	--	--	-47.00	--

Note: 1. The margins of the other spectrum are not exceeding the minimum value of margin, and this part of the results without recording in the test report.  
2. Measurements above show only up to 6 maximum emissions noted, or would be lesser, with "--" remark, if no specific emission from the EUT are recorded (ie: margin>20dB from the applicable limit) and considered that's already beyond the background noise floor.

Any report having not been signed by authorized approver, or having been altered without authorization, or having not been stamped by the "Dedicated Testing/Inspection Stamp" is deemed to be invalid. Copying or excerpting portion of, or altering the content of the report is not permitted without the written authorization of AGC. The test results presented in the report apply only to the tested sample. Any objections to report issued by AGC should be submitted to AGC within 15days after the issuance of the test report. Further enquiry of validity or verification of the test report should be addressed to AGC by agc01@agccert.com.

## 5.8. RECEIVER BLOCKING

### 5.8.1 LIMIT

Receiver Blocking parameters for Receiver Category 1 equipment

Wanted signal mean power from companion device (dBm) (see notes 1 and 4)	Blocking signal frequency (MHz)	Blocking signal power (dBm) (see note 4)	Type of blocking signal
(-133 dBm + 10 × log <sub>10</sub> (OCBW)) or -68 dBm whichever is less (see note 2)	2 380	-34	CW
	2 504		
(-139 dBm + 10 × log <sub>10</sub> (OCBW)) or -74 dBm whichever is less (see note 3)	2 300		
	2 330		
	2 360		
	2 524		
	2 584		
	2 674		

NOTE 1: OCBW is in Hz.

NOTE 2: In case of radiated measurements using a companion device and the level of the wanted signal from the companion device cannot be determined, a relative test may be performed using a wanted signal up to  $P_{min} + 26$  dB where  $P_{min}$  is the minimum level of wanted signal required to meet the minimum performance criteria as defined in clause 4.3.2.11.3 in the absence of any blocking signal.

NOTE 3: In case of radiated measurements using a companion device and the level of the wanted signal from the companion device cannot be determined, a relative test may be performed using a wanted signal up to  $P_{min} + 20$  dB where  $P_{min}$  is the minimum level of wanted signal required to meet the minimum performance criteria as defined in clause 4.3.2.11.3 in the absence of any blocking signal.

NOTE 4: The level specified is the level at the UUT receiver input assuming a 0 dBi antenna assembly gain. In case of conducted measurements, this level has to be corrected for the (in-band) antenna assembly gain (G). In case of radiated measurements, this level is equivalent to a power flux density (PFD) in front of the UUT antenna with the UUT being configured/positioned as recorded in clause 5.4.3.2.2.

Receiver Blocking parameters for Receiver Category 2 equipment

Wanted signal mean power from companion device (dBm) (see notes 1 and 3)	Blocking signal frequency (MHz)	Blocking signal power (dBm) (see note 3)	Type of blocking signal
(-139 dBm + 10 × log <sub>10</sub> (OCBW) + 10 dB) or (-74 dBm + 10 dB) whichever is less (see note 2)	2 380	-34	CW
	2 504		
	2 300		
	2 584		

NOTE 1: OCBW is in Hz.

NOTE 2: In case of radiated measurements using a companion device and the level of the wanted signal from the companion device cannot be determined, a relative test may be performed using a wanted signal up to P<sub>min</sub> + 26 dB where P<sub>min</sub> is the minimum level of wanted signal required to meet the minimum performance criteria as defined in clause 4.3.2.11.3 in the absence of any blocking signal.

NOTE 3: The level specified is the level at the UUT receiver input assuming a 0 dBi antenna assembly gain. In case of conducted measurements, this level has to be corrected for the (in-band) antenna assembly gain (G). In case of radiated measurements, this level is equivalent to a power flux density (PFD) in front of the UUT antenna with the UUT being configured/positioned as recorded in clause 5.4.3.2.2.

Receiver Blocking parameters for Receiver Category 3 equipment

Wanted signal mean power from companion device (dBm) (see notes 1 and 3)	Blocking signal frequency (MHz)	Blocking signal power (dBm) (see note 3)	Type of blocking signal
(-139 dBm + 10 × log <sub>10</sub> (OCBW) + 20 dB) or (-74 dBm + 20 dB) whichever is less (see note 2)	2 380	-34	CW
	2 504		
	2 300		
	2 584		

NOTE 1: OCBW is in Hz.

NOTE 2: In case of radiated measurements using a companion device and the level of the wanted signal from the companion device cannot be determined, a relative test may be performed using a wanted signal up to P<sub>min</sub> + 30 dB where P<sub>min</sub> is the minimum level of wanted signal required to meet the minimum performance criteria as defined in clause 4.3.2.11.3 in the absence of any blocking signal.

NOTE 3: The level specified is the level at the UUT receiver input assuming a 0 dBi antenna assembly gain. In case of conducted measurements, this level has to be corrected for the (in-band) antenna assembly gain (G). In case of radiated measurements, this level is equivalent to a power flux density (PFD) in front of the UUT antenna with the UUT being configured/positioned as recorded in clause 5.4.3.2.2.

Any report having not been signed by authorized approver, or having been altered without authorization, or having not been stamped by the "Dedicated Testing/Inspection Stamp" is deemed to be invalid. Copying or excerpting portion of, or altering the content of the report is not permitted without the written authorization of AGC. The test results presented in the report apply only to the tested sample. Any objections to report issued by AGC should be submitted to AGC within 15days after the issuance of the test report. Further enquiry of validity or verification of the test report should be addressed to AGC by agc01@agccert.com.

### 5.8.2 TEST PROCEDURE

For non-FHSS equipment, having more than one operating channel, the operating channels on which the testing has to be performed shall be selected as follows:

- For testing blocking frequencies less than 2 400 MHz, the equipment shall operate on the lowest operating channel.
- For testing blocking frequencies greater than 2 500 MHz, the equipment shall operate on the highest operating channel.

The simplified conducted measure procedures are as follows:

- 1) For non-FHSS equipment, the UUT shall be set to the lowest operating channel on which the blocking test has to be performed.
- 2) The blocking signal generator is set to the first frequency as defined in the appropriate table corresponding to the receiver category and type of equipment.
- 3) With the blocking signal generator switched off, a communication link is established between the UUT and the associated companion device using the test setup. The level of the wanted signal shall be set to the value provided in the table corresponding to the receiver category and type of equipment. This level may be measured directly at the output of the companion device and a correction is made for the coupling loss into the UUT. The actual level for the wanted signal shall be recorded in the test report.
- 4) The blocking signal at the UUT is set to the level provided in the table corresponding to the receiver category and type of equipment. It shall be verified and recorded in the test report that the performance criteria is met.
- 5) Repeat step 4 for each remaining combination of frequency and level for the blocking signal as provided in the table corresponding to the receiver category and type of equipment.
- 6) Repeat step 2 to step 5 with the UUT operating at the highest operating channel.

Any report having not been signed by authorized approver, or having been altered without authorization, or having not been stamped by the "Dedicated Testing/Inspection Stamp" is deemed to be invalid. Copying or excerpting portion of, or altering the content of the report is not permitted without the written authorization of AGC. The test results presented in the report apply only to the tested sample. Any objections to report issued by AGC should be submitted to AGC within 15days after the issuance of the test report. Further enquiry of validity or verification of the test report should be addressed to AGC by [agc01@agccert.com](mailto:agc01@agccert.com).

### 5.8.3 TEST CONFIGURATION

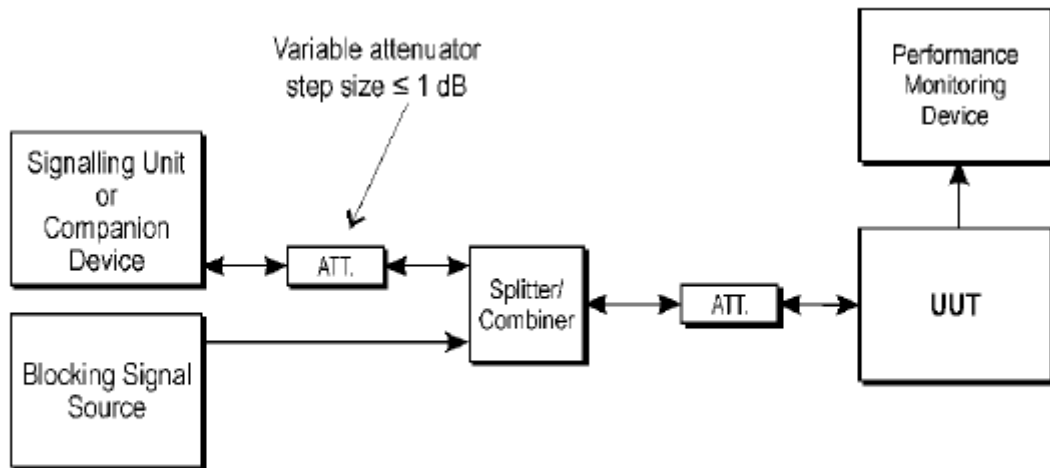

**Test Set-up for receiver blocking**

### 5.8.4 TEST RESULT

#### BLE 1Mbps

Test channel	Blocking Signal Frequency(MHz)	Blocking Signal Power(dBm)	Wanted signal mean power from companion device(dBm)	Performance PER	Limit PER	Result
Low	2 300	-32.71	-67.48	1.56%	10%	Pass
	2 380	-32.71	-67.48	0.94%	10%	
High	2 504	-32.71	-67.49	2.34%	10%	
	2 584	-32.71	-67.49	1.26%	10%	

#### BLE 2Mbps

Test channel	Blocking Signal Frequency(MHz)	Blocking Signal Power(dBm)	Wanted signal mean power from companion device(dBm)	Performance PER	Limit PER	Result
Low	2 300	-32.71	-64.59	1.73%	10%	Pass
	2 380	-32.71	-64.59	0.86%	10%	
High	2 504	-32.71	-64.60	2.55%	10%	
	2 584	-32.71	-64.60	1.37%	10%	

Note: The levels of the blocking signal and wanted signal have to be corrected for the (in-band) antenna assembly gain.

Any report having not been signed by authorized approver, or having been altered without authorization, or having not been stamped by the "Dedicated Testing/Inspection Stamp" is deemed to be invalid. Copying or excerpting portion of, or altering the content of the report is not permitted without the written authorization of AGC. The test results presented in the report apply only to the tested sample. Any objections to report issued by AGC should be submitted to AGC within 15days after the issuance of the test report. Further enquiry of validity or verification of the test report should be addressed to AGC by agc01@agccert.com.



## APPENDIX A: PHOTOGRAPHS OF TEST SETUP

### RADIATED SPURIOUS EMISSION TEST SETUP



RADIATED SPURIOUS EMISSION ABOVE 1G TEST SETUP



Any report having not been signed by authorized approver, or having been altered without authorization, or having not been stamped by the “Dedicated Testing/Inspection Stamp” is deemed to be invalid. Copying or excerpting portion of, or altering the content of the report is not permitted without the written authorization of AGC. The test results presented in the report apply only to the tested sample. Any objections to report issued by AGC should be submitted to AGC within 15days after the issuance of the test report. Further enquiry of validity or verification of the test report should be addressed to AGC by [agc01@agccert.com](mailto:agc01@agccert.com).

### CONDUCTED TEST SETUP

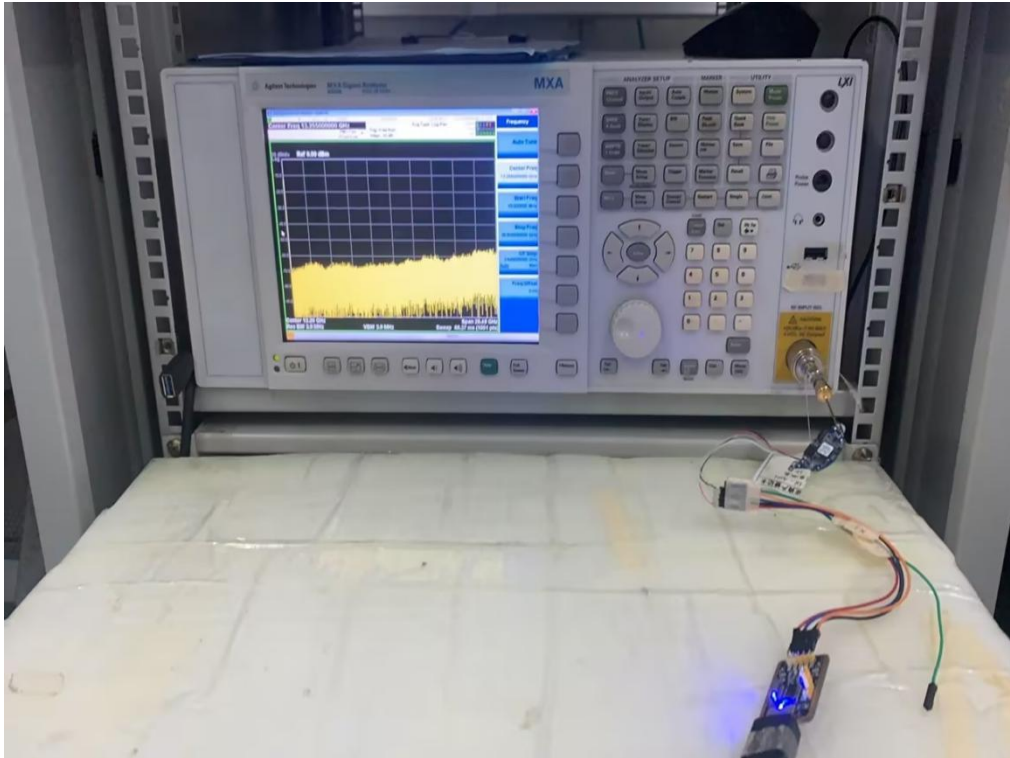

Any report having not been signed by authorized approver, or having been altered without authorization, or having not been stamped by the “Dedicated Testing/Inspection Stamp” is deemed to be invalid. Copying or excerpting portion of, or altering the content of the report is not permitted without the written authorization of AGC. The test results presented in the report apply only to the tested sample. Any objections to report issued by AGC should be submitted to AGC within 15days after the issuance of the test report. Further enquiry of validity or verification of the test report should be addressed to AGC by [agc01@agccert.com](mailto:agc01@agccert.com).

Attestation of Global Compliance(Shenzhen)Co., Ltd  
Attestation of Global Compliance(Shenzhen)Std & Tech Co., Ltd  
Tel: +86-755 2523 4088 E-mail: [agc@agccert.com](mailto:agc@agccert.com) Web: <http://www.agccert.com/>

## **APPENDIX B: PHOTOGRAPHS OF EUT**

Refer to the Report No.: AGC14435230901AP01

**----END OF REPORT----**

Any report having not been signed by authorized approver, or having been altered without authorization, or having not been stamped by the "Dedicated Testing/Inspection Stamp" is deemed to be invalid. Copying or excerpting portion of, or altering the content of the report is not permitted without the written authorization of AGC. The test results presented in the report apply only to the tested sample. Any objections to report issued by AGC should be submitted to AGC within 15days after the issuance of the test report. Further enquiry of validity or verification of the test report should be addressed to AGC by [agc01@agccert.com](mailto:agc01@agccert.com).

Attestation of Global Compliance(Shenzhen)Co., Ltd

Attestation of Global Compliance(Shenzhen)Std & Tech Co., Ltd

Tel: +86-755 2523 4088 E-mail: [agc@agccert.com](mailto:agc@agccert.com) Web: <http://www.agccert.com/>



## Conditions of Issuance of Test Reports

1. All samples and goods are accepted by the Attestation of Global Compliance (Shenzhen) Co., Ltd (the “Company”) solely for testing and reporting in accordance with the following terms and conditions. The company provides its services on the basis that such terms and conditions constitute express agreement between the company and any person, firm or company requesting its services (the “Clients”).
2. Any report issued by Company as a result of this application for testing services (the “Report”) shall be issued in confidence to the Clients and the Report will be strictly treated as such by the Company. It may not be reproduced either in its entirety or in part and it may not be used for advertising or other unauthorized purposes without the written consent of the Company. The Clients to whom the Report is issued may, however, show or send it, or a certified copy thereof prepared by the Company to its customer, supplier or other persons directly concerned. The Company will not, without the consent of the Clients, enter into any discussion or correspondence with any third party concerning the contents of the Report, unless required by the relevant governmental authorities, laws or court orders.
3. The Company shall not be called or be liable to be called to give evidence or testimony on the Report in a court of law without its prior written consent, unless required by the relevant governmental authorities, laws or court orders.
4. In the event of the improper use of the report as determined by the Company, the Company reserves the right to withdraw it, and to adopt any other additional remedies which may be appropriate.
5. Samples submitted for testing are accepted on the understanding that the Report issued cannot form the basis of, or be the instrument for, any legal action against the Company.
6. The Company will not be liable for or accept responsibility for any loss or damage however arising from the use of information contained in any of its Reports or in any communication whatsoever about its said tests or investigations.
7. Clients wishing to use the Report in court proceedings or arbitration shall inform the Company to that effect prior to submitting the sample for testing.
8. The Company is not responsible for recalling the electronic version of the original report when any revision is made to them. The Client assumes the responsibility to providing the revised version to any interested party who uses them.
9. Subject to the variable length of retention time for test data and report stored hereinto as otherwise specifically required by individual accreditation authorities, the Company will only keep the supporting test data and information of the test report for a period of six years. The data and information will be disposed of after the aforementioned retention period has elapsed. Under no circumstances shall we provide any data and information which has been disposed of after retention period. Under no circumstances shall we be liable for damage of any kind, including (but not limited to) compensatory damages, lost profits, lost data, or any form of special, incidental, indirect, consequential or punitive damages of any kind, whether based on breach of contract of warranty, tort (including negligence), product liability or otherwise, even if we are informed in advance of the possibility of such damages.

Any report having not been signed by authorized approver, or having been altered without authorization, or having not been stamped by the “Dedicated Testing/Inspection Stamp” is deemed to be invalid. Copying or excerpting portion of, or altering the content of the report is not permitted without the written authorization of AGC. The test results presented in the report apply only to the tested sample. Any objections to report issued by AGC should be submitted to AGC within 15days after the issuance of the test report. Further enquiry of validity or verification of the test report should be addressed to AGC by [agc01@agccert.com](mailto:agc01@agccert.com).