



RADIO TEST REPORT

ETSI EN 301 893 V2.1.1 (2017-05)

Product : Tablet PC

Trade Mark : Blackview

Model Name : Active 8 Pro

Family Model : N/A

Report No. : S23081004401004

Prepared for

DOKE COMMUNICATION (HK) LIMITED

RM 1902 EASEY COMM BLDG 253-261 HENNESSY ROAD WANCHAI HK CHINA

Prepared by

Shenzhen NTEK Testing Technology Co., Ltd.

1&5/F, Building C, 1&2/F, Building E, Fenda Science Park, Sanwei Community,
Hangcheng Street, Baoan District, Shenzhen, Guangdong, China

Tel. 400-800-6106, 0755-2320 0050, 0755-2320 0090

Website: <http://www.ntek.org.cn>

TEST RESULT CERTIFICATION

Applicant's name : DOKE COMMUNICATION (HK) LIMITED
Address : RM 1902 EASEY COMM BLDG 253-261 HENNESSY ROAD
 WANCHAI HK CHINA

Manufacturer's Name : Shenzhen DOKE Electronic Co., Ltd
Address : 801, Building3, 7th Industrial Zone, Yulv Community, Yutang
 Road, Guangming District, Shenzhen, China.

Product description

Product name : Tablet PC
Trademark : Blackview
Model and/or type reference : Active 8 Pro
Family Model : N/A

Standards : ETSI EN 301 893 V2.1.1 (2017-05)

This device described above has been tested by Shenzhen NTEK, and the test results show that the equipment under test (EUT) is in compliance with the 2014/53/EU RED Directive Art.3.2 requirements. And it is applicable only to the tested sample identified in the report.

This report shall not be reproduced except in full, without the written approval of Shenzhen NTEK, this document may be altered or revised by Shenzhen NTEK, personnel only, and shall be noted in the revision of the document.

Test Sample Number : S230526008001

Date of Test

Date (s) of performance of tests : May 29, 2023 ~ Jun 21, 2023

Date of Issue..... : Aug 30, 2023

Test Result..... : **Pass**

*Note: All test data of this report are based on the original test report
 S23052600801004 dated by Jun 25, 2023*

Testing Engineer : 

 (Allen Liu)

Authorized Signatory : 

 (Alex Li)

Table of Contents

Page

| | |
|---|----|
| 1 . SUMMARY OF TEST RESULTS | 6 |
| 1.1 TEST FACILITY | 7 |
| 1.2 MEASUREMENT UNCERTAINTY | 7 |
| 2 . GENERAL INFORMATION | 8 |
| 2.1 GENERAL DESCRIPTION OF EUT | 8 |
| 2.2 TEST CONDITIONS AND CHANNEL | 10 |
| 2.3 DESCRIPTION OF TEST CONDITIONS | 11 |
| 2.4 DESCRIPTION OF SUPPORT UNITS | 12 |
| 2.5 EQUIPMENTS LIST FOR ALL TEST ITEMS | 13 |
| 3 . CENTRE FREQUENCIES | 14 |
| 3.1 APPLIED PROCEDURES / LIMIT | 14 |
| 3.1.1 LIMIT | 14 |
| 3.1.2 TEST PROCEDURES | 14 |
| 3.1.3 TEST MOTHOD | 14 |
| 3.1.4 TEST SETUP LAYOUT | 15 |
| 3.1.5 TEST RESULTS | 16 |
| 4 . NOMINAL CHANNEL BANDWIDTH AND OCCUPIED CHANNEL BANDWIDTH19 | |
| 4.1 APPLIED PROCEDURES / LIMIT | 19 |
| 4.1.1 LIMIT | 19 |
| 4.1.2 TEST PROCEDURES | 19 |
| 4.1.3 TEST METHOD | 20 |
| 4.1.4 TEST SETUP LAYOUT | 20 |
| 4.1.5 TEST RESULTS | 21 |
| 5 . RF OUTPUT POWER, TRANSMIT POWER CONTROL (TPC) AND POWER DENSITY | 22 |
| 5.1 APPLIED PROCEDURES / LIMIT | 22 |
| 5.2 TEST PROCEDURES | 22 |
| 5.3 TEST SETUP LAYOUT | 22 |
| 5.4 TEST RESULTS | 23 |
| 6 . TRANSMITTER UNWANTED EMISSIONS OUTSIDE THE 5 GHZ RLAN BANDS24 | |
| 6.1 APPLIED PROCEDURES / LIMIT | 24 |
| 6.1.1 CONFORMANCE | 24 |
| 6.1.2 TEST RESULTS (30MHz ~ 1000MHz) | 25 |
| 6.1.3 TEST RESULTS (1.0GHz ~26GHz) | 26 |
| 7 . TRANSMITTER UNWANTED EMISSIONS WITHIN THE 5 GHZ RLAN BANDS27 | |
| 7.1 APPLIED PROCEDURES / LIMIT | 27 |
| 7.1.1 TEST PROCEDURES | 27 |
| 7.1.2 TEST SETUP LAYOUT | 27 |

Table of Contents

Page

| | |
|---|-----------|
| 7.1.3 TEST RESULTS | 28 |
| 8 . RECEIVER SPURIOUS EMISSIONS | 29 |
| 8.1 APPLIED PROCEDURES / LIMIT | 29 |
| 8.1.1 TEST PROCEDURES | 29 |
| 8.1.2 TEST SETUP LAYOUT | 29 |
| 8.1.3 TEST RESULTS | 30 |
| 9 . ADAPTIVITY (CHANNEL ACCESS MECHANISM) | 31 |
| 9.1 APPLICABILITY OF ADAPTIVE REQUIREMENTS AND LILIT | 31 |
| 9.2 TEST SETUP CONFIGURATION | 32 |
| 9.3 LIST OF MEASUREMENTS | 32 |
| 9.4 TEST RESULTS | 32 |
| 10 . RECEIVER BLOCKING | 33 |
| 10.1 LIMITS OF RECEIVER BLOCKING | 33 |
| 10.2 TEST PROCEDURE | 33 |
| 10.3 DEVIATION FROM TEST STANDARD | 33 |
| 10.4 TEST SETUP | 33 |
| 10.5 TEST RESULTS | 34 |
| 11 . USER ACCESS RESTRICTIONS | 35 |
| 11.1 APPLIED PROCEDURES / LIMIT | 35 |
| 11.2 TEST RESULTS | 35 |
| 12 . GEO-LOCATION CAPABILITY | 35 |
| 12.1 APPLIED PROCEDURES / LIMIT | 35 |
| 12.2 TEST RESULTS | 35 |
| 13 TEST RESULTS | 36 |
| 13.1 Occupied Channel Bandwidth | 36 |
| 13.2 RF Output Power | 40 |
| 13.3 Power Spectral Density | 44 |
| 13.4 Transmitter unwanted emissions in the spurious domain | 48 |
| 13.5 Transmitter unwanted emissions within the 5 GHz RLAN bands | 52 |
| 13.6 Receiver spurious emissions | 59 |
| 13.7 Adaptivity | 63 |
| 13.8 Adaptivity COT Channel Occupancy Time | 72 |
| 13.9 Adaptivity COT Idle Period Probability | 75 |
| 14. EUT TEST PHOTO | 78 |
| SPURIOUS EMISSIONS MEASUREMENT PHOTOS | 78 |
| APPENDIX-PHOTOGRAPHS OF EUT CONSTRUCTIONAL DETAILS | |

1. SUMMARY OF TEST RESULTS

Test procedures according to the technical standards:

| ETSI EN 301 893 V2.1.1 | | | |
|------------------------|---|----------------|------|
| Clause | Test Item | Applicable | NOTE |
| 4.2.1 | Centre Frequencies | Compliance | |
| 4.2.2 | Nominal Channel Bandwidth and Occupied Channel Bandwidth | Compliance | |
| 4.2.3 | RF output power | Compliance | |
| 4.2.3 | Transmit Power Control (TPC) | Not Applicable | |
| 4.2.3 | Power Density | Compliance | |
| 4.2.4.1 | Transmitter unwanted emissions outside the 5 GHz RLAN bands | Compliance | |
| 4.2.4.2 | Transmitter unwanted emissions within the 5 GHz RLAN bands | Compliance | |
| 4.2.5 | Receiver spurious emissions | Compliance | |
| 4.2.6 | Dynamic Frequency Selection (DFS) | Not Applicable | |
| 4.2.7 | Adaptivity (Channel Access Mechanism) | Compliance | |
| 4.2.8 | Receiver Blocking | Compliance | |
| 4.2.9 | User Access Restrictions | Compliance | |
| 4.2.10 | Geo-location capability | Compliance* | |

Note:

1. Compliance*: Please refer to the product information declared by the manufacturer.
2. The antenna gain provided by customer is used to calculate the EIRP result. NTEK is not responsible for the accuracy of antenna gain parameter.

1.1 TEST FACILITY

Shenzhen NTEK Testing Technology Co., Ltd.

Add. : 1/F, Building E, Fenda Science Park, Sanwei Community, Xixiang Street, Bao'an District, Shenzhen 518126 P.R. China

FCC Registered No.: 238937 IC Registered No.:9270A-1

CNAS Registration No.:L5516

1.2 MEASUREMENT UNCERTAINTY

The reported uncertainty of measurement $y \pm U$, where expanded uncertainty U is based on a standard uncertainty multiplied by a coverage factor of $k=2$, providing a level of confidence of approximately **95 %**.

| No. | Item | Uncertainty |
|-----|------------------------------|-------------------------|
| 1 | Conducted Emission Test | $\pm 1.38\text{dB}$ |
| 2 | RF power,conducted | $\pm 0.16\text{dB}$ |
| 3 | Spurious emissions,conducted | $\pm 0.21\text{dB}$ |
| 4 | All emissions,radiated(<1G) | $\pm 4.68\text{dB}$ |
| 5 | All emissions,radiated(>1G) | $\pm 4.89\text{dB}$ |
| 6 | Temperature | $\pm 0.5^\circ\text{C}$ |
| 7 | Humidity | $\pm 2\%$ |

2. GENERAL INFORMATION

2.1 GENERAL DESCRIPTION OF EUT

| | | |
|---------------------|---|---|
| Equipment | Tablet PC | |
| Trade Mark | Blackview | |
| Model Name. | Active 8 Pro | |
| Family Model | N/A | |
| Model Difference | N/A | |
| Product Description | The EUT is a Tablet PC | |
| | Operation Frequency: | 802.11a/ n(20/40)/ac(20/40/80): <input checked="" type="checkbox"/> 5180MHz~5240MHz(20MHz) <input checked="" type="checkbox"/> 5190MHz~5230MHz(40MHz) <input checked="" type="checkbox"/> 5210MHz(80MHz) |
| | Modulation Type: | 802.11a: OFDM (BPSK / QPSK / 16QAM) 802.11n: OFDM (QPSK/BPSK/16QAM/64QAM) 802.11ac:OFDM (QPSK/BPSK/16QAM/64QAM/256QAM) |
| | Bit Rate of Transmitter | 802.11a: 6/9/12/18/24/36/48/54Mbps; 802.11n (20MHz): up to MCS0-7 802.11n (40MHz): up to MCS0-7 802.11ac (20MHz): up to MCS0-8 802.11ac (40MHz): up to MCS0-9 802.11ac (80MHz): up to MCS0-9 |
| | Number Of Channel | Please see Note 2. |
| | Antenna Designation: | PIFA Antenna |
| | Antenna Gain(Peak) | 1.2 dBi |
| | Based on the application, features, or specification exhibited in User's Manual, the EUT is considered as an ITE/Computing Device. More details of EUT technical specification, please refer to the User's Manual. | |
| Channel List | Refer to below | |
| Adapter | Model: HJ-C6-33-EU Input: 100-240V~50/60Hz 0.8A Output: (PD) 5.0V---3.0A 15.0W or 9.0V---3.0A 27.0W or 12.0V---2.5A 30.0W or 15.0V---2.0A 30.0W or 20.0V---1.5A 30.0W (PPS)3.3V-11.0V---3.0A (33.0W MAX) | |
| Battery | DC 3.87V, 22000mAh | |
| Rating | DC 3.87V from battery or DC 5V from adapter | |
| Hardware Version | TP769_A1_V1.0 | |
| Software Version | Active8Pro_EEA_TP769_V1.0 | |

| | | | | | | | | | | | | | | | | | | | | | | | | | | | | | | | | | | | | | | | | | | | | | | | | | | | | | | | | | | | | | | | | | | | | | | | | | | | | | |
|--|--|---------|------------------------|---------|------------------------|---------|------------------------|--|--|--|--|--|--|--|--|---------|------------------------|---------|------------------------|---------|------------------------|---------|------------------------|----|------|----|------|---|---|---|---|----|------|----|------|---|---|---|---|---|--|--|--|--|--|--|--|---------|------------------------|---------|------------------------|---------|------------------------|---------|------------------------|----|------|---|---|---|---|---|---|----|------|---|---|---|---|---|---|--|--|---------|-----------------|----|------|
| Note: | | | | | | | | | | | | | | | | | | | | | | | | | | | | | | | | | | | | | | | | | | | | | | | | | | | | | | | | | | | | | | | | | | | | | | | | | | | | | |
| 1. | For a more detailed features description, please refer to the manufacturer's specifications or the User's Manual. | | | | | | | | | | | | | | | | | | | | | | | | | | | | | | | | | | | | | | | | | | | | | | | | | | | | | | | | | | | | | | | | | | | | | | | | | | | | |
| 2. | <input checked="" type="checkbox"/> <table border="1" style="width: 100%; text-align: center;"> <tr> <td colspan="8">802.11a/n/ac(20MHz) Carrier Frequency Channel</td> </tr> <tr> <td>Channel</td> <td>Frequen cy (MHz)</td> <td>Channel</td> <td>Frequen cy (MHz)</td> <td>Channel</td> <td>Frequen cy (MHz)</td> <td>Channel</td> <td>Frequen cy (MHz)</td> </tr> <tr> <td>36</td> <td>5180</td> <td>44</td> <td>5220</td> <td>-</td> <td>-</td> <td>-</td> <td>-</td> </tr> <tr> <td>40</td> <td>5200</td> <td>48</td> <td>5240</td> <td>-</td> <td>-</td> <td>-</td> <td>-</td> </tr> </table> <input checked="" type="checkbox"/> <table border="1" style="width: 100%; text-align: center;"> <tr> <td colspan="8">802.11n/ac(40MHz) Carrier Frequency Channel</td> </tr> <tr> <td>Channel</td> <td>Frequen cy (MHz)</td> <td>Channel</td> <td>Frequen cy (MHz)</td> <td>Channel</td> <td>Frequen cy (MHz)</td> <td>Channel</td> <td>Frequen cy (MHz)</td> </tr> <tr> <td>38</td> <td>5190</td> <td>-</td> <td>-</td> <td>-</td> <td>-</td> <td>-</td> <td>-</td> </tr> <tr> <td>46</td> <td>5230</td> <td>-</td> <td>-</td> <td>-</td> <td>-</td> <td>-</td> <td>-</td> </tr> </table> <input checked="" type="checkbox"/> <table border="1" style="width: 100%; text-align: center;"> <tr> <td colspan="2">802.11ac (80MHz) Carrier Frequency Channel</td> </tr> <tr> <td>Channel</td> <td>Frequency (MHz)</td> </tr> <tr> <td>42</td> <td>5210</td> </tr> </table> | | | | | | | 802.11a/n/ac(20MHz) Carrier Frequency Channel | | | | | | | | Channel | Frequen cy (MHz) | Channel | Frequen cy (MHz) | Channel | Frequen cy (MHz) | Channel | Frequen cy (MHz) | 36 | 5180 | 44 | 5220 | - | - | - | - | 40 | 5200 | 48 | 5240 | - | - | - | - | 802.11n/ac(40MHz) Carrier Frequency Channel | | | | | | | | Channel | Frequen cy (MHz) | Channel | Frequen cy (MHz) | Channel | Frequen cy (MHz) | Channel | Frequen cy (MHz) | 38 | 5190 | - | - | - | - | - | - | 46 | 5230 | - | - | - | - | - | - | 802.11ac (80MHz) Carrier Frequency Channel | | Channel | Frequency (MHz) | 42 | 5210 |
| 802.11a/n/ac(20MHz) Carrier Frequency Channel | | | | | | | | | | | | | | | | | | | | | | | | | | | | | | | | | | | | | | | | | | | | | | | | | | | | | | | | | | | | | | | | | | | | | | | | | | | | | |
| Channel | Frequen cy (MHz) | Channel | Frequen cy (MHz) | Channel | Frequen cy (MHz) | Channel | Frequen cy (MHz) | | | | | | | | | | | | | | | | | | | | | | | | | | | | | | | | | | | | | | | | | | | | | | | | | | | | | | | | | | | | | | | | | | | | | | |
| 36 | 5180 | 44 | 5220 | - | - | - | - | | | | | | | | | | | | | | | | | | | | | | | | | | | | | | | | | | | | | | | | | | | | | | | | | | | | | | | | | | | | | | | | | | | | | | |
| 40 | 5200 | 48 | 5240 | - | - | - | - | | | | | | | | | | | | | | | | | | | | | | | | | | | | | | | | | | | | | | | | | | | | | | | | | | | | | | | | | | | | | | | | | | | | | | |
| 802.11n/ac(40MHz) Carrier Frequency Channel | | | | | | | | | | | | | | | | | | | | | | | | | | | | | | | | | | | | | | | | | | | | | | | | | | | | | | | | | | | | | | | | | | | | | | | | | | | | | |
| Channel | Frequen cy (MHz) | Channel | Frequen cy (MHz) | Channel | Frequen cy (MHz) | Channel | Frequen cy (MHz) | | | | | | | | | | | | | | | | | | | | | | | | | | | | | | | | | | | | | | | | | | | | | | | | | | | | | | | | | | | | | | | | | | | | | | |
| 38 | 5190 | - | - | - | - | - | - | | | | | | | | | | | | | | | | | | | | | | | | | | | | | | | | | | | | | | | | | | | | | | | | | | | | | | | | | | | | | | | | | | | | | | |
| 46 | 5230 | - | - | - | - | - | - | | | | | | | | | | | | | | | | | | | | | | | | | | | | | | | | | | | | | | | | | | | | | | | | | | | | | | | | | | | | | | | | | | | | | | |
| 802.11ac (80MHz) Carrier Frequency Channel | | | | | | | | | | | | | | | | | | | | | | | | | | | | | | | | | | | | | | | | | | | | | | | | | | | | | | | | | | | | | | | | | | | | | | | | | | | | | |
| Channel | Frequency (MHz) | | | | | | | | | | | | | | | | | | | | | | | | | | | | | | | | | | | | | | | | | | | | | | | | | | | | | | | | | | | | | | | | | | | | | | | | | | | | |
| 42 | 5210 | | | | | | | | | | | | | | | | | | | | | | | | | | | | | | | | | | | | | | | | | | | | | | | | | | | | | | | | | | | | | | | | | | | | | | | | | | | | |

2.2 TEST CONDITIONS AND CHANNEL

Test conditions:

| | Normal Test Conditions | Extreme Test Conditions |
|-------------------|------------------------|-------------------------|
| Temperature | 15°C - 35°C | 40°C ~ -10°C Note: (1) |
| Relative Humidity | 20% - 75% | N/A |
| Supply Voltage | DC 3.87V | / |

Note:

(1) The HT 40°C and LT -10°C was declared by manufacturer, The EUT couldn't be operate normally with higher or lower temperature.

Test channels:

Please refer to the table below:

| Test | Clause | Test channels | | |
|---|--------|---|---------------------------|---|
| | | Lower sub-band (5 150 MHz to 5 350 MHz) | | Higher sub-band 5 470 MHz to 5 725 MHz |
| | | 5 150 MHz to 5 250 MHz | 5 250 MHz to 5 350 MHz | |
| Centre frequencies | 5.4.2 | C7 (see note 1) | | C8 (see note 1) |
| Occupied Channel Bandwidth | 5.4.3 | C7 | | C8 |
| Power/ Power Density | 5.4.4 | C1 | C2 | C3, C4 |
| Transmitter unwanted emissions outside the 5 GHz RLAN bands | 5.4.5 | C7 (see note 1) | | C8 (see note 1) |
| Transmitter unwanted emissions within the 5 GHz RLAN bands | 5.4.6 | C1 | C2 | C3, C4 |
| Receiver spurious emissions | 5.4.7 | C7 (see note 1) | | C8 (see note 1) |
| Transmit Power Control (TPC) | 5.4.4 | n.a. (see note 2) | C2 (see note 1) | C3, C4 (see note 1) |
| Dynamic Frequency Selection (DFS) | 5.4.8 | n.a. (see note 2) | C5 | C6 (see note 3) |
| Adaptivity | 5.4.9 | C9 | | |
| Receiver Blocking | 5.4.10 | C7 | | C8 |

C1, C3: The lowest declared channel for every declared Nominal Channel Bandwidth within this band. For the Power Density testing, it is sufficient to only perform this test using the lowest Nominal Channel Bandwidth.

C2, C4: The highest declared channel for every declared Nominal Channel Bandwidth within this band. For the Power Density testing, it is sufficient to only perform this test using the lowest Nominal Channel Bandwidth.

C5, C6: One channel out of the declared channels for this frequency range. If more than one Nominal Channel Bandwidth has been declared for this sub-band, testing shall be performed using the lowest and highest Nominal Channel Bandwidth.

C7, C8: One channel out of the declared channels for this sub-band. For Occupied Channel Bandwidth, testing shall be repeated for every declared Nominal Channel Bandwidth within this sub-band.

C9: One channel (in case of single-channel testing) or a group of channels (in case of multi-channel testing) out of the declared channels.

NOTE 1: In case of more than one channel plan has been declared, testing of these specific requirements need only be performed using one of the declared channel plans.

NOTE 2: Testing is not required for Nominal Channel Bandwidths that fall completely within the frequency range 5 150 MHz to 5 250 MHz.

NOTE 3: Where the declared channel plan includes channels whose Nominal Channel Bandwidth falls completely or partly within the 5 600 MHz to 5 650 MHz band, the tests for the Channel Availability Check (and where implemented, for the Off-Channel CAC) shall be performed on one of these channels in addition to a channel within the band 5 470 MHz to 5 600 MHz or within the band 5 650 MHz to 5 725 MHz.

NOTE 4: For Receiver Blocking, just test the channel of smallest channel bandwidth and the lowest data rate.

2.3 DESCRIPTION OF TEST CONDITIONS

E-1
EUT

2.4 DESCRIPTION OF SUPPORT UNITS

The EUT has been tested as an independent unit together with other necessary accessories or support units. The following support units or accessories were used to form a representative test configuration during the tests.

| Item | Equipment | Model/Type No. | Series No. | Note |
|------|-----------|----------------|------------|------|
| E-1 | Tablet PC | Active 8 Pro | N/A | EUT |
| | | | | |
| | | | | |

| Item | Type | Shielded Type | Ferrite Core | Length | Note |
|------|------|---------------|--------------|--------|------|
| | | | | | |
| | | | | | |
| | | | | | |
| | | | | | |

Note:

- (1) The support equipment was authorized by Declaration of Confirmation.
- (2) For detachable type I/O cable should be specified the length in cm in 『Length』 column.

2.5 EQUIPMENTS LIST FOR ALL TEST ITEMS

| EQUIPMENT TYPE | Manufacturer | Type No. | Serial No. | Last calibration | Calibrated until | Calibration period |
|--|--------------------|----------------|----------------|--------------------------|--------------------------|--------------------|
| EMI Test Receiver | R&S | ESPI7 | 101318 | 2023.03.27 | 2024.03.26 | 1 year |
| Bilog Antenna | TESEQ | CBL6111D | 31216 | 2023.03.27 | 2024.03.26 | 1 year |
| Turn Table | EM | SC100_1 | 60531 | N/A | N/A | N/A |
| Antnna Mast | EM | SC100 | N/A | N/A | N/A | N/A |
| Horn Antenna | EM | EM-AH-10180 | 2011071402 | 2023.03.27 | 2024.03.26 | 1 year |
| Horn Ant | Schwarzbeck | BBHA 9170 | 9170-181 | 2023.03.27 | 2024.03.26 | 1 year |
| Test Cable (30MHz-1GHz) | N/A | R-01 | N/A | 2022.06.17 | 2025.06.16 | 3 year |
| Test Cable (1-18GHz) | N/A | R-02 | N/A | 2022.06.17 | 2025.06.16 | 3 year |
| 50Ω Coaxial Switch | Anritsu | MP59B | 6200983705 | 2023.05.06 | 2026.05.05 | 3 year |
| Pre-Amplifier | EMC | EMC051835SE | 980246 | 2022.06.17 2023.06.15 | 2023.06.16 2023.06.14 | 1 year |
| Spectrum Analyzer | Agilent | E4407B | MY45108040 | 2023.03.27 | 2024.03.26 | 1 year |
| Filter | TRILTHIC | 2400MHz | 29 | 2023.03.27 | 2024.03.26 | 3 year |
| Attenuator | Weinschel | 33-10-33 | AR4010 | 2023.03.27 | 2024.03.26 | 3 year |
| Attenuator | Weinschel | 24-20-34 | BP4485 | 2023.03.27 | 2024.03.26 | 3 year |
| MXA Signal Analyzer | Agilent | N9020A | MY49100060 | 2022.06.17 2023.06.15 | 2023.06.16 2023.06.14 | 1 year |
| ESG VETCTOR SIGNAL GENERAROR | Agilent | E4438C | MY45093347 | 2023.03.27 | 2024.03.26 | 1 year |
| Power Splitter | Mini-Circuits/ USA | ZN2PD-63-S+ | SF025101428 | 2023.03.27 | 2024.03.26 | 3 year |
| Coupler | Mini-Circuits | ZADC-10-63-S + | SF794101410 | 2023.03.27 | 2024.03.26 | 3 year |
| Directional Coupler | MCLI/USA | CB11-20 | 0D2L51502 | 2020.07.17 | 2023.07.16 | 3 year |
| Attenuator | Agilent | 8495B | MY42147029 | 2023.03.27 | 2024.03.26 | 3 year |
| Power Meter | DARE | RPR3006W | 15I00041SNO 84 | 2022.06.17 2023.06.15 | 2023.06.16 2023.06.14 | 1 year |
| MXG Vector Signal Generator | Agilent | N5182A | MY47070317 | 2022.06.17 2023.06.15 | 2023.06.16 2023.06.14 | 1 year |
| Wideband Radio Communication Tester Specifications | R&S | CMW500 | 148500 | 2022.06.17 2023.06.15 | 2023.06.16 2023.06.14 | 1 year |
| temporary antenna connector (Note) | NTS | R001 | N/A | N/A | N/A | N/A |

3. CENTRE FREQUENCIES

3.1 APPLIED PROCEDURES / LIMIT

3.1.1 LIMIT

The actual centre frequency for any given channel declared by the manufacturer shall be maintained within the range $f_c \pm 20$ ppm

3.1.2 TEST PROCEDURES

Test conditions

These measurements shall be performed under both normal and extreme test conditions (see clause 5.1.1).

The channels on which the conformance requirements in clause 4.2 shall be verified are defined in clause 5.1.3.

The UUT shall be configured to operate at a normal RF Output Power level. In addition, the UUT shall be configured to operate on a single channel.

For a UUT with antenna connector(s) and using dedicated external antenna(s), or for a UUT with integral antenna(s) but with a temporary antenna connector(s) provided, conducted measurements shall be used.

In case of conducted measurements on smart antenna systems (devices with multiple transmit chains) the measurements shall be performed on only one of the active transmit chains.

For a UUT with integral antenna(s) and without a temporary antenna connector(s), radiated measurements shall be used.

3.1.3 TEST METHOD

Conducted measurement:

1. Equipment operating without modulation

This test method requires that the UUT can be operated in an unmodulated test mode.

The UUT shall be connected to a frequency counter and operated in an unmodulated mode. The result shall be recorded.

2. Equipment operating with modulation

This method is an alternative to the above method in case the UUT cannot be operated in an un-modulated mode.

The UUT shall be connected to spectrum analyser.

The settings of the spectrum analyser shall be adjusted to optimize the instruments frequency accuracy.

Max Hold shall be selected and the centre frequency adjusted to that of the UUT.

The peak value of the power envelope shall be measured and noted. The span shall be reduced and the marker moved in a positive frequency increment until the upper, (relative to the centre frequency), -10 dBc point is reached. This value shall be noted as f1.

The marker shall then be moved in a negative frequency increment until the lower, (relative to the centre frequency), -10 dBc point is reached. This value shall be noted as f2.

The centre frequency is calculated as $(f1 + f2) / 2$.

Radiated measurement:

The test set up as described in annex B (ETSI EN 301 893 V2.1.1) shall be used with a spectrum analyser of sufficient accuracy attached to the test antenna.

The test procedure is as described under conducted measurement.

3.1.4 TEST SETUP LAYOUT

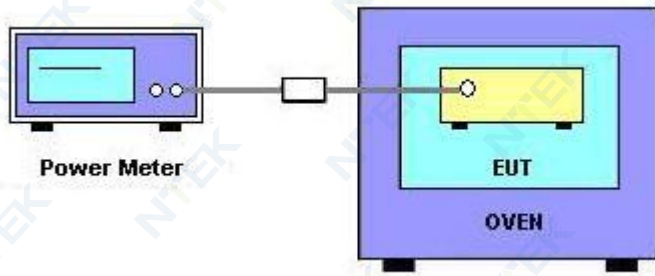

3.1.5 TEST RESULTS

| | | | |
|---------------|--|-------------------|--------------|
| EUT : | Tablet PC | Model Name : | Active 8 Pro |
| Temperature : | 20 °C | Relative Humidity | 54% |
| Pressure : | 1012 hPa | Test Voltage : | DC 3.87V |
| Test Mode : | Tx Mode-802.11(a/n20/n40/ac20/ac40/ac80) | | |

802.11a

| TEST CONDITIONS | | | | Reference Frequency: 5180MHz | | | |
|-----------------|-----|-----------|------|------------------------------|---------|-----------|---------------------------|
| | | | | fL | fH | (fL+fH)/2 | Frequency Deviation (ppm) |
| T nom (°C) | 20 | V nom (V) | 3.87 | 5171.59 | 5188.38 | 5179.984 | -3.087 |
| T min (°C) | -10 | V nom (V) | | 5171.59 | 5188.39 | 5179.992 | -1.463 |
| T max (°C) | 40 | V nom (V) | | 5171.56 | 5188.38 | 5179.968 | -6.176 |
| Limits | | | | ± 20 ppm | | | |
| Result | | | | Complies | | | |

802.11n20

| TEST CONDITIONS | | | | Reference Frequency: 5180MHz | | | |
|-----------------|-----|-----------|------|------------------------------|---------|-----------|---------------------------|
| | | | | fL | fH | (fL+fH)/2 | Frequency Deviation (ppm) |
| T nom (°C) | 20 | V nom (V) | 3.87 | 5171.58 | 5188.39 | 5179.984 | -3.137 |
| T min (°C) | -10 | V nom (V) | | 5171.59 | 5188.40 | 5179.995 | -1.046 |
| T max (°C) | 40 | V nom (V) | | 5171.56 | 5188.37 | 5179.968 | -6.264 |
| Limits | | | | ± 20 ppm | | | |
| Result | | | | Complies | | | |

802.11n40

| TEST CONDITIONS | | | | Reference Frequency: 5190MHz | | | |
|-----------------|-----|-----------|------|------------------------------|---------|-----------|---------------------------|
| | | | | fL | fH | (fL+fH)/2 | Frequency Deviation (ppm) |
| T nom (°C) | 20 | V nom (V) | 3.87 | 5171.56 | 5208.38 | 5189.969 | -5.907 |
| T min (°C) | -10 | V nom (V) | | 5171.58 | 5208.39 | 5189.987 | -2.537 |
| T max (°C) | 40 | V nom (V) | | 5171.62 | 5208.37 | 5189.994 | -1.080 |
| Limits | | | | ± 20 ppm | | | |
| Result | | | | Complies | | | |

802.11ac20

| TEST CONDITIONS | | | | Reference Frequency: 5180MHz | | | |
|-----------------|-----|-----------|------|------------------------------|---------|-----------|---------------------------|
| | | | | fL | fH | (fL+fH)/2 | Frequency Deviation (ppm) |
| T nom (°C) | 20 | V nom (V) | 3.87 | 5171.58 | 5188.41 | 5179.996 | -0.775 |
| T min (°C) | -10 | V nom (V) | | 5171.59 | 5188.39 | 5179.994 | -1.078 |
| T max (°C) | 40 | V nom (V) | | 5171.56 | 5188.37 | 5179.967 | -6.444 |
| Limits | | | | ± 20 ppm | | | |
| Result | | | | Complies | | | |

802.11ac40

| TEST CONDITIONS | | | | Reference Frequency: 5190MHz | | | |
|-----------------|-----|-----------|------|------------------------------|---------|-----------|---------------------------|
| | | | | fL | fH | (fL+fH)/2 | Frequency Deviation (ppm) |
| T nom (°C) | 20 | V nom (V) | 3.87 | 5171.57 | 5208.38 | 5189.973 | -5.153 |
| T min (°C) | -10 | V nom (V) | | 5171.60 | 5208.40 | 5189.998 | -0.408 |
| T max (°C) | 40 | V nom (V) | | 5171.58 | 5208.39 | 5189.988 | -2.348 |
| Limits | | | | ± 20 ppm | | | |
| Result | | | | Complies | | | |

802.11ac80

| TEST CONDITIONS | | | | Reference Frequency: 5210MHz | | | |
|-----------------|-----|-----------|------|------------------------------|---------|-----------|---------------------------|
| | | | | fL | fH | (fL+fH)/2 | Frequency Deviation (ppm) |
| T nom (°C) | 20 | V nom (V) | 3.87 | 5171.56 | 5248.37 | 5209.967 | -6.290 |
| T min (°C) | -10 | V nom (V) | | 5171.56 | 5248.38 | 5209.973 | -5.273 |
| T max (°C) | 40 | V nom (V) | | 5171.56 | 5248.37 | 5209.968 | -6.212 |
| Limits | | | | ± 20 ppm | | | |
| Result | | | | Complies | | | |

4. NOMINAL CHANNEL BANDWIDTH AND OCCUPIED CHANNEL BANDWIDTH

4.1 APPLIED PROCEDURES / LIMIT

4.1.1 LIMIT

The Nominal Channel Bandwidth shall be at least 5 MHz at all times.

The Occupied Channel Bandwidth shall be between 80 % and 100 % of the declared Nominal Channel Bandwidth. In case of smart antenna systems (devices with multiple transmit chains) each of the transmit chains shall meet this requirement.

NOTE: During an established communication, a device is allowed to operate temporarily in a mode where its Occupied Channel Bandwidth may be reduced to as low as 40 % of its Nominal Channel Bandwidth with a minimum of 4 MHz.

4.1.2 TEST PROCEDURES

Test conditions

The conformance requirements shall be verified only under normal operating conditions, and on those channels and channel bandwidths defined in clause 5.1.3(ETSI EN 301 893 V2.1.1).

The measurements shall be performed using normal operation of the equipment with the test signal applied.

The UUT shall be configured to operate at a typical RF power output level.

When equipment has simultaneous transmissions in adjacent channels, these transmissions may be considered as one signal with an actual Nominal Channel Bandwidth of 'n' times the individual Nominal Channel Bandwidth where 'n' is the number of adjacent channels. When equipment has simultaneous transmissions in non-adjacent channels, each power envelope shall be considered separately.

For a UUT with antenna connector(s) and using dedicated external antenna(s), or for a UUT with integral antenna(s) but with a temporary antenna connector(s) provided, conducted measurements shall be used.

In case of conducted measurements on smart antenna systems (devices with multiple transmit chains) measurements need only to be performed on one of the active transmit chains (antenna outputs).

For a UUT with integral antenna(s) and without a temporary antenna connector(s), radiated measurements shall be used.

4.1.3 TEST METHOD

Conducted measurement

The measurement procedure shall be as follows:

Step 1:

Connect the UUT to the spectrum analyser and use the following settings:

- Centre Frequency: The centre frequency of the channel under test
- Resolution BW: 100 kHz
- Video BW: 300 kHz
- Frequency Span: 2 x Nominal Bandwidth (e.g. 40 MHz for a 20 MHz channel)
- > 1 s; for larger Nominal Bandwidths, the sweep time may be increased until a value where the sweep time has no impact on the RMS value of the signal
- Detector Mode: RMS
- Trace Mode: Max Hold

Step 2:

Wait for the trace to stabilize.

Step 3:

- Make sure that the power envelope is sufficiently above the noise floor of the analyser to avoid the noise signals left and right from the power envelope being taken into account by this measurement.
- Use the 99 % bandwidth function of the spectrum analyser to measure the Occupied Channel Bandwidth of the UUT. This value shall be recorded.

The measurement described in step 1 to step 3 above shall be repeated in case of simultaneous transmissions in non-adjacent channels.

Radiated measurement

The test set up as described in annex B (ETSI EN 301 893 V2.1.1) and the applicable measurement procedures described in annex C (ETSI EN 301 893 V2.1.1) shall be used. The test procedure is as described under conducted measurement.

4.1.4 TEST SETUP LAYOUT

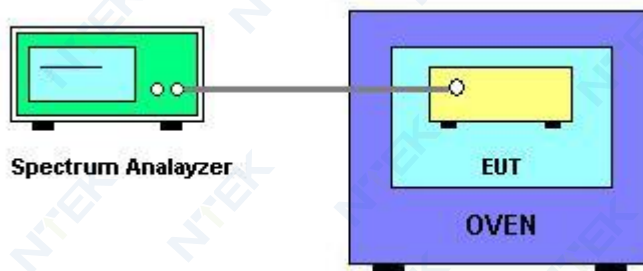

4.1.5 TEST RESULTS

| | | | |
|---------------|--|--------------------|--------------|
| EUT : | Tablet PC | Model Name : | Active 8 Pro |
| Temperature : | 24°C | Relative Humidity: | 54 % |
| Pressure : | 1012 hPa | Test Voltage : | DC 3.87V |
| Test Mode : | TX Mode-802.11(a/n20/n40/ac20/ac40/ac80) | | |

Test data reference attachment

5. RF OUTPUT POWER, TRANSMIT POWER CONTROL (TPC) AND POWER DENSITY

5.1 APPLIED PROCEDURES / LIMIT

TPC is not required for channels whose nominal bandwidth falls completely within the band 5 150 MHz to 5 250 MHz.

For devices with TPC, the RF output power and the power density when configured to operate at the highest stated power level of the TPC range shall not exceed the levels given in table 2.

Devices are allowed to operate without TPC. See table 2 for the applicable limits in this case.

Table 2: Mean e.i.r.p. limits for RF output power and power density at the highest power level

| Frequency range [MHz] | Mean e.i.r.p. limit [dBm] | | Mean e.i.r.p. density limit [dBm/MHz] | |
|-----------------------|---------------------------|--------------------|---------------------------------------|-------------------|
| | with TPC | without TPC | with TPC | without TPC |
| 5 150 to 5 350 | 23 | 20/23 (see note 1) | 10 | 7/10 (see note 2) |
| 5 470 to 5 725 | 30 (see note 3) | 27 (see note 3) | 17 (see note 3) | 14 (see note 3) |

NOTE 1: The applicable limit is 20 dBm, except for transmissions whose nominal bandwidth falls completely within the band 5 150 MHz to 5 250 MHz, in which case the applicable limit is 23 dBm.

NOTE 2: The applicable limit is 7 dBm/MHz, except for transmissions whose nominal bandwidth falls completely within the band 5 150 MHz to 5 250 MHz, in which case the applicable limit is 10 dBm/MHz.

NOTE 3: Slave devices without a Radar Interference Detection function shall comply with the limits for the band 5 250 MHz to 5 350 MHz.

For devices using TPC, the RF output power during a transmission burst when configured to operate at the lowest stated power level of the TPC range shall not exceed the levels given in table 3. For devices without TPC, the limits in table 3 do not apply.

Table 3: Mean e.i.r.p. limits for RF output power at the lowest power level of the TPC range

| Frequency range | Mean e.i.r.p. [dBm] |
|------------------------|---------------------|
| 5 250 MHz to 5 350 MHz | 17 |
| 5 470 MHz to 5 725 MHz | 24 (see note) |

NOTE: Slave devices without a Radar Interference Detection function shall comply with the limits for the band 5 250 MHz to 5 350 MHz.

5.2 TEST PROCEDURES

According to ETSI EN 301 893 V2.1.1 (2017-05) §5.4.4

5.3 TEST SETUP LAYOUT

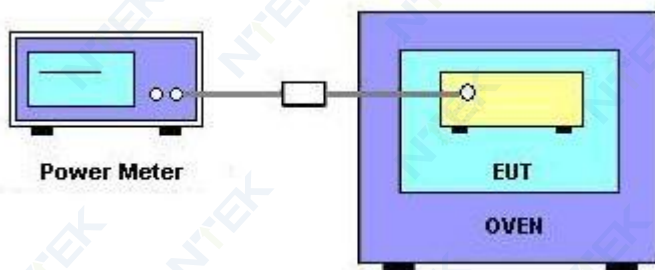

5.4 TEST RESULTS

RF Output Power

| | | | |
|---------------|--|--------------------|--------------|
| EUT : | Tablet PC | Model Name : | Active 8 Pro |
| Temperature : | 24°C | Relative Humidity: | 54 % |
| Pressure : | 1012 hPa | Test Voltage : | DC 3.87V |
| Test Mode : | Tx Mode-802.11(a/n20/n40/ac20/ac40/ac80) | | |

Test data reference attachment

Power density

| | | | |
|---------------|--|--------------------|--------------|
| EUT : | Tablet PC | Model Name : | Active 8 Pro |
| Temperature : | 24°C | Relative Humidity: | 54 % |
| Pressure : | 1012 hPa | Test Voltage : | DC 3.87V |
| Test Mode : | Tx Mode-802.11(a/n20/n40/ac20/ac40/ac80) | | |

Test data reference attachment

6. TRANSMITTER UNWANTED EMISSIONS OUTSIDE THE 5 GHZ RLAN BANDS

6.1 APPLIED PROCEDURES / LIMIT

The level of transmitter unwanted emissions outside the 5 GHz RLAN bands shall not exceed the limits given in table 4.

In case of equipment with antenna connectors, these limits apply to emissions at the antenna port (conducted) and to the emissions radiated by the cabinet. In case of integral antenna equipment (without temporary antenna connectors), these limits apply to emissions radiated by the equipment

Table 4: Transmitter unwanted emission limits outside the 5 GHz RLAN bands

| Frequency range | Maximum power | Bandwidth |
|----------------------|---------------|-----------|
| 30 MHz to 47 MHz | -36 dBm | 100 kHz |
| 47 MHz to 74 MHz | -54 dBm | 100 kHz |
| 74 MHz to 87,5 MHz | -36 dBm | 100 kHz |
| 87,5 MHz to 118 MHz | -54 dBm | 100 kHz |
| 118 MHz to 174 MHz | -36 dBm | 100 kHz |
| 174 MHz to 230 MHz | -54 dBm | 100 kHz |
| 230 MHz to 470 MHz | -36 dBm | 100 kHz |
| 470 MHz to 862 MHz | -54 dBm | 100 kHz |
| 862 MHz to 1 GHz | -36 dBm | 100 kHz |
| 1 GHz to 5,15 GHz | -30 dBm | 1 MHz |
| 5,35 GHz to 5,47 GHz | -30 dBm | 1 MHz |
| 5,725 GHz to 26 GHz | -30 dBm | 1 MHz |

6.1.1 CONFORMANCE

Conformance tests as defined in clause 5.4.5 shall be carried out.

6.1.2 TEST RESULTS (30MHz ~ 1000MHz)

| | | | |
|---------------|------------|---------------------|--------------|
| EUT : | Tablet PC | Model Name : | Active 8 Pro |
| Temperature : | 24 °C | Relative Humidity : | 57% |
| Pressure : | 1010 hPa | Test Power : | DC 3.87V |
| Test Mode : | TX-802.11a | | |

| Polar (H/V) | Frequency | Meter Reading | Factor | Emission Level | Limits | Margin | Remark |
|-------------|-----------|---------------|--------|----------------|--------|--------|--------|
| | (MHz) | (dBm) | (dB) | (dBm) | (dBm) | (dB) | |
| V | 41.913 | -76.22 | 12.19 | -64.03 | -54 | -10.03 | peak |
| V | 100.918 | -76.96 | 14.95 | -62.01 | -36 | -26.01 | peak |
| V | 219.97 | -75.5 | 18.42 | -57.08 | -36 | -21.08 | peak |
| V | 337.67 | -84.76 | 24.77 | -59.99 | -54 | -5.99 | peak |
| V | 653.897 | -77.91 | 28.62 | -49.29 | -36 | -13.29 | peak |
| V | 529.725 | -74.46 | 29.96 | -44.5 | -36 | -8.5 | peak |
| H | 36.151 | -74.82 | 11.92 | -62.9 | -54 | -8.9 | peak |
| H | 98.832 | -74.11 | 12.58 | -61.53 | -36 | -25.53 | peak |
| H | 221.087 | -75.04 | 10.91 | -64.13 | -54 | -10.13 | peak |
| H | 255.586 | -87.32 | 22.16 | -65.16 | -54 | -11.16 | peak |
| H | 602.766 | -87.93 | 24.77 | -63.16 | -54 | -9.16 | peak |
| H | 780.681 | -74.43 | 28.62 | -45.81 | -36 | -9.81 | peak |

Remark:

Emission Level= Meter Reading+ Factor, Margin= Emission Level - Limit

Note: "802.11a" is the worst mode, the test report records only the worst-case test values.

6.1.3 TEST RESULTS (1.0GHz ~26GHz)

| | | | |
|---------------|--------------------------------|---------------------|--------------|
| EUT : | Tablet PC | Model Name : | Active 8 Pro |
| Temperature : | 24 °C | Relative Humidity : | 54% |
| Pressure : | 1010 hPa | Test Power : | DC 3.87V |
| Test Mode : | TX-802.11ac20 (CH36/CH40/CH48) | | |

| Polar | Frequency | Meter Reading | Factor | Emission Level | Limits | Margin | Remark |
|---|-----------|---------------|--------|----------------|--------|--------|--------|
| (H/V) | (MHz) | (dBm) | (dB) | (dBm) | (dBm) | (dB) | |
| operation frequency:5180 | | | | | | | |
| V | 10360 | -56.3 | 13.82 | -42.48 | -30 | -12.48 | peak |
| V | 15540 | -56.95 | 14.91 | -42.04 | -30 | -12.04 | peak |
| H | 10360 | -57.17 | 13.82 | -43.35 | -30 | -13.35 | peak |
| H | 15540 | -59.04 | 14.91 | -44.13 | -30 | -14.13 | peak |
| operation frequency:5200 | | | | | | | |
| V | 10400 | -57.45 | 13 | -44.45 | -30 | -14.45 | peak |
| V | 15600 | -61.22 | 14.95 | -46.27 | -30 | -16.27 | peak |
| H | 10400 | -60.96 | 13 | -47.96 | -30 | -17.96 | peak |
| H | 15600 | -56.71 | 14.95 | -41.76 | -30 | -11.76 | peak |
| operation frequency:5240 | | | | | | | |
| V | 10480 | -56.3 | 13.81 | -42.49 | -30 | -12.49 | peak |
| V | 15720 | -59.23 | 15.29 | -43.94 | -30 | -13.94 | peak |
| H | 10480 | -56.1 | 13.81 | -42.29 | -30 | -12.29 | peak |
| H | 15720 | -59.81 | 15.29 | -44.52 | -30 | -14.52 | peak |
| Remark: | | | | | | | |
| Emission Level= Meter Reading+ Factor, Margin= Emission Level - Limit | | | | | | | |

Note: "802.11a" is the worst mode, the test report records only the worst-case test values.

7. TRANSMITTER UNWANTED EMISSIONS WITHIN THE 5 GHZ RLAN BANDS

7.1 APPLIED PROCEDURES / LIMIT

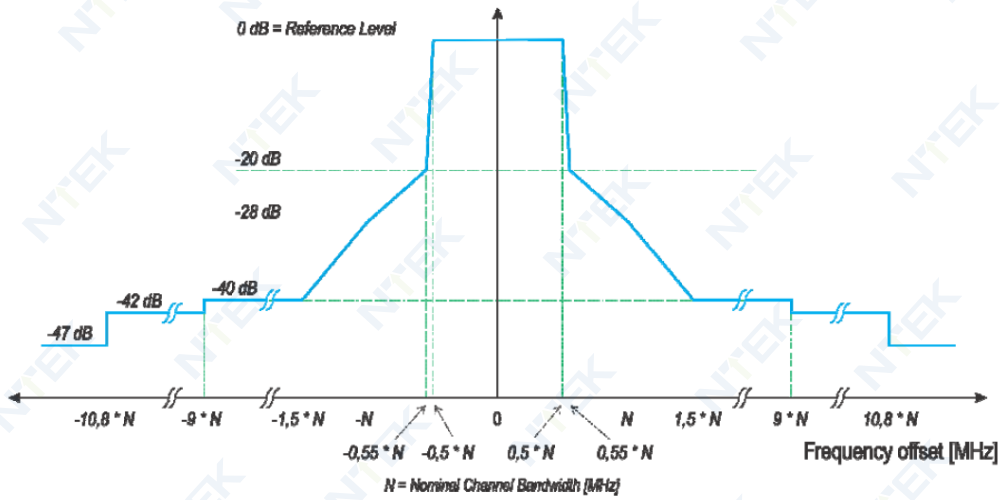

NOTE: dBc is the spectral density relative to the maximum spectral power density of the transmitted signal.

Figure 1: Transmit spectral power mask

7.1.1 TEST PROCEDURES

According to ETSI EN 301 893 V2.1.1 (2017-05) §5.4.6

7.1.2 TEST SETUP LAYOUT

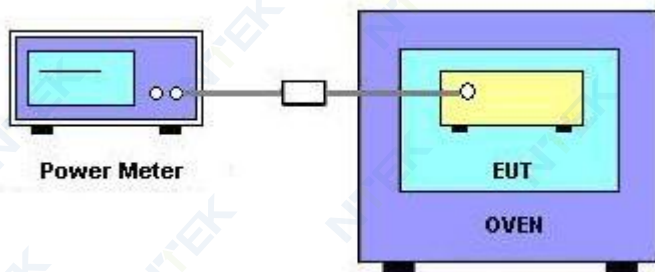

7.1.3 TEST RESULTS

| | | | |
|---------------|--|--------------------|------------------|
| EUT : | Tablet PC | Model Name : | Active 8 Pro |
| Temperature : | 24°C | Relative Humidity: | 54 % |
| Pressure : | 1012 hPa | Test Voltage : | DC 3.87V(NORMAL) |
| Test Mode : | Tx Mode-802.11(a/n20/n40/ac20/ac40/ac80) | | |

Test data reference attachment

8. RECEIVER SPURIOUS EMISSIONS

8.1 APPLIED PROCEDURES / LIMIT

The spurious emissions of the receiver shall not exceed the limits given in table 5.

In case of equipment with antenna connectors, these limits apply to emissions at the antenna port (conducted) and to the emissions radiated by the cabinet. In case of integral antenna equipment (without temporary antenna connectors), these limits apply to emissions radiated by the equipment.

Table 5: Spurious radiated emission limits

| Frequency range | Maximum power | Measurement bandwidth |
|-----------------|---------------|-----------------------|
| 30 MHz to 1 GHz | -57 dBm | 100 kHz |
| 1 GHz to 26 GHz | -47 dBm | 1 MHz |

8.1.1 TEST PROCEDURES

According to ETSI EN 301 893 V2.1.1 (2017-05) §5.4.7

8.1.2 TEST SETUP LAYOUT

This test setup layout is the same as that shown in section 6.1.4

8.1.3 TEST RESULTS

| | | | |
|---------------|------------|---------------------|--------------|
| EUT : | Tablet PC | Model Name : | Active 8 Pro |
| Temperature : | 24°C | Relative Humidity : | 57 % |
| Pressure : | 1012 hPa | Test Power : | DC 3.87V |
| Test Mode : | RX-802.11a | | |

BELOW 1G

| Polar (H/V) | Frequency | Meter Reading | Factor | Emission Level | Limits | Margin | Remark |
|-------------|-----------|---------------|--------|----------------|--------|--------|--------|
| | (MHz) | (dBm) | (dB) | (dBm) | (dBm) | (dB) | |
| V | 38.587 | -71.41 | 6.48 | -64.93 | -57 | -7.93 | peak |
| V | 111.391 | -77.89 | 12.17 | -65.72 | -57 | -8.72 | peak |
| V | 226.284 | -80.38 | 15.64 | -64.74 | -57 | -7.74 | peak |
| V | 438.639 | -91.72 | 19.95 | -71.77 | -57 | -14.77 | peak |
| V | 522.37 | -83.12 | 20.6 | -62.52 | -57 | -5.52 | peak |
| H | 32.699 | -78.28 | 12.35 | -65.93 | -57 | -8.93 | peak |
| H | 106.434 | -81.76 | 10.84 | -70.92 | -57 | -13.92 | peak |
| H | 191.554 | -79.12 | 11.1 | -68.02 | -57 | -11.02 | peak |
| H | 434.41 | -81.24 | 17.87 | -63.37 | -57 | -6.37 | peak |
| H | 675.146 | -89.78 | 20.6 | -69.18 | -57 | -12.18 | peak |

Remark:

Emission Level= Meter Reading+ Factor, Margin= Emission Level - Limit

ABOVE 1G

| Polar (H/V) | Frequency | Meter Reading | Factor | Emission Level | Limits | Margin | Remark |
|-------------|-----------|---------------|--------|----------------|--------|--------|--------|
| | (MHz) | (dBm) | (dB) | (dBm) | (dBm) | (dB) | |
| V | 2597.599 | -62.33 | 7.58 | -54.75 | -47 | -7.75 | peak |
| V | 4874.001 | -63.23 | 8.36 | -54.87 | -47 | -7.87 | peak |
| V | 2575.754 | -64.16 | 8.96 | -55.2 | -47 | -8.2 | peak |
| V | 4981.231 | -64.39 | 5.16 | -59.23 | -47 | -12.23 | peak |
| H | 2602.207 | -62.52 | 7.73 | -54.79 | -47 | -7.79 | peak |
| H | 5508.29 | -63.93 | 8.2 | -55.73 | -47 | -8.73 | peak |
| H | 2722.11 | -63.77 | 8.27 | -55.5 | -47 | -8.5 | peak |
| H | 4717.801 | -64.76 | 5.18 | -59.58 | -47 | -12.58 | peak |

Remark:

Emission Level= Meter Reading+ Factor, Margin= Emission Level - Limit

Note: "802.11a" is the worst mode, the test report records only the worst-case test values.

9. ADAPTIVITY (CHANNEL ACCESS MECHANISM)

9.1 APPLICABILITY OF ADAPTIVE REQUIREMENTS AND LILIT

This requirement applies to equipment, testing shall be performed using the highest nominal channel Bandwidth. The manufacturer shall state whether the UUT is capable of operating as a Frame Based Equipment or Load Based Equipment. See tables for the applicability of adaptive requirements and limit for each of the operational modes.

Applicability of adaptive requirements and limit

| Requirement | Operational Mode | | |
|---|---|--|---|
| | Frame Based Equipment | Load Based Equipment (CCA using 'energy detect') | Load Based Equipment (CCA not using any of the mechanisms referenced) |
| Minimum Clear Channel Assessment (CCA) Time | 20 us (see note 1) | (see note 2) | 20 us (see note 1) |
| Maximum Channel Occupancy (COT) Time | 1ms to 10 ms | (see note 2) | (13/32)*q ms (see note 3) |
| Minimum Idle Period | 5% of COT | (see note 2) | NA |
| Extended CCA check | NA | (see note 2) | N*CCA (see note 4) |
| Short Control Signalling Transmissions | Maximum duty cycle of 5% within an observation period of 50 ms (see note 5) | | |

Note 1: The CCA time used by the equipment shall be declared by the manufacturer.
 Note 2: LBT based spectrum sharing mechanism based on the Clear Channel Assessment (CCA) mode using 'energy detect', as described in IEEE 802.11™-2007[9], clauses 15 and 17, in IEEE 802.11n™ -2009[10], clauses 20.
 Note 3: q is selected by the manufacturer in the range [4...32]
 Note 4: The value of N shall be randomly selected in the range [1...q]
 Note 5: Adaptive equipment may or may not have Short Control Signaling Transmissions.

Interference threshold level

| Maximum transmit power (P _H) EIRP dBm | Threshold Level (TL) (see note 1 and 2) |
|--|--|
| 9.81 | -73 dBm / MHz |

Note 1: $TL = -73 \text{ dBm / MHz} + (23 - PH) / (1 \text{ MHz})$ (assuming a 0 dBi receive antenna and PH specified in dBm e.i.r.p)
 Note 2: Transmitter the CCA threshold level (TL) shall be equal or lower than -73 dBm / MHz at the input to the receiver (assuming a 0 dBi receive antenna).

TEST PROCEDURE

Reference to ETSI EN 301 893 V2.1.1 (2017-05) clause 5.4.9

9.2 TEST SETUP CONFIGURATION

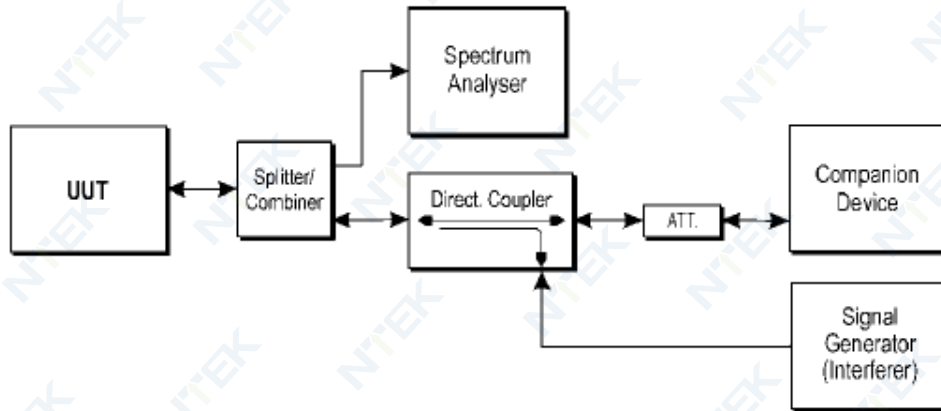

Figure 13: Example Test Set-up for verifying the adaptivity of an equipment

9.3 LIST OF MEASUREMENTS

| UUT operational Mode | | |
|-----------------------|--|---|
| Frame Based Equipment | Load Based Equipment (CCA using 'energy detect') | Load Based Equipment (CCA not using any of the mechanisms referenced) |
| | V | |

| Clause | Test Parameter | Remarks | PASS/FAIL |
|---------|---------------------------------------|----------------|-----------|
| 4.9.2.1 | Adaptive (Frame Based Equipment) | Not Applicable | N/A |
| 4.9.2.2 | Adaptive (Load Based Equipment) | Applicable | PASS |
| 4.9.2.3 | Short Control Signaling Transmissions | Applicable | PASS |

9.4 TEST RESULTS

| | | | |
|---------------|-----------|---------------------|--------------|
| EUT : | Tablet PC | Model Name : | Active 8 Pro |
| Temperature : | 24°C | Relative Humidity : | 54 % |
| Pressure : | 1012 hPa | Test Power : | DC 3.87V |
| TEST RESULTS | Pass | | |

Test data reference attachment

10. RECEIVER BLOCKING

10.1 LIMITS OF RECEIVER BLOCKING

Performance Criteria

The minimum performance criterion shall be a PER of less than or equal to 10 %. The manufacturer may declare alternative performance criteria as long as that is appropriate for the intended use of the equipment (see clause 5.4.1, item s)).

While maintaining the minimum performance criteria as defined in clause 4.2.8.3, the blocking levels at specified frequency offsets shall be equal to or greater than the limits defined in table 7.

Table 9: Receiver Blocking parameters

| Wanted signal mean power from companion device (dBm) | Blocking signal Frequency (MHz) | Blocking signal power (dBm) (see note 2) | Type of blocking signal |
|--|---------------------------------|--|-------------------------|
| P _{min} + 6 dB | 5 100 | -59 | CW |
| P _{min} + 6 dB | 4 900 5 000 5 975 | -53 | CW |

NOTE 1: P_{min} is the minimum level of the wanted signal (in dBm) required to meet the minimum performance criteria as defined clause 4.2.8.3 in the absence of any blocking signal.

NOTE 2: The levels specified are levels in front of the UUT antenna. In case of conducted measurements, the same levels should be used at the antenna connector irrespective of antenna gain.

10.2 TEST PROCEDURE

Refer to chapter 5.4.10 of ETSI EN 301 893 V2.1.1 (2017-05)

| Measurement | |
|---|---|
| <input checked="" type="checkbox"/> Conducted measurement | <input type="checkbox"/> Radiated measurement |

10.3 DEVIATION FROM TEST STANDARD

No deviation

10.4 TEST SETUP

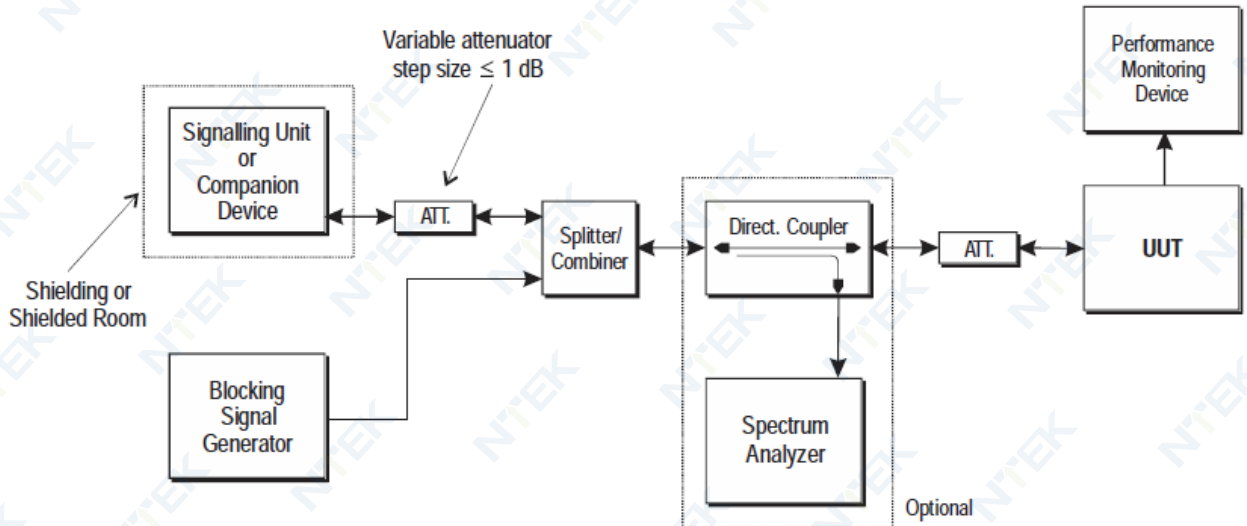

Figure 14: Test Set-up for receiver blocking

10.5 TEST RESULTS

| | | | |
|---------------|------------|---------------------|--------------|
| EUT : | Tablet PC | Model Number : | Active 8 Pro |
| Temperature : | 24°C | Relative Humidity : | 54 % |
| Pressure : | 1012 hPa | Test Voltage : | DC 3.87V |
| Test Mode : | RX 802.11a | | |

CH 36-5180MHz

| Wanted signal mean power from companion device (dBm) <small>Note(1)</small> | Blocking signal Frequency (MHz) | Blocking signal power (dBm) | PER % <small>Note(1)</small> | PER Limit % |
|---|---------------------------------|-----------------------------|------------------------------|-------------|
| -72 + 6 dB | 5100 | -59 | 0.33 | ≤10% |
| -72 + 6 dB | 4900 | -53 | 0.47 | ≤10% |
| | 5000 | | 0.51 | |
| | 5975 | | 0.14 | |

CH 48-5240MHz

| Wanted signal mean power from companion device (dBm) <small>Note(1)</small> | Blocking signal Frequency (MHz) | Blocking signal power (dBm) | PER % <small>Note(1)</small> | PER Limit % |
|---|---------------------------------|-----------------------------|------------------------------|-------------|
| -72 + 6 dB | 5100 | -59 | 0.57 | ≤10% |
| -72 + 6 dB | 4900 | -53 | 0.33 | ≤10% |
| | 5000 | | 0.41 | |
| | 5975 | | 0.32 | |

Note: (1) The above results were obtained from laboratory tests.

11. USER ACCESS RESTRICTIONS

11.1 APPLIED PROCEDURES / LIMIT

The equipment shall be so constructed that settings (hardware and/or software) related to DFS shall not be accessible to the user if changing those settings result in the equipment no longer being compliant with the DFS requirements in clause 4.2.6.

The above requirement includes the prevention of indirect access to any setting that impacts DFS. The following is a non-exhaustive list of examples of such indirect access.

11.2 TEST RESULTS

| | | | |
|---------------|-----------|---------------------|--------------|
| EUT : | Tablet PC | Model Name : | Active 8 Pro |
| Temperature : | 24°C | Relative Humidity : | 54 % |
| Pressure : | 1012 hPa | Test Power : | DC 3.87V |
| TEST RESULTS | Pass | | |

Conclusion:

1. The DUT does not allow the user to change the country of operation and/or the operating frequency band.
2. The equipment does not accept software and/or firmware which results in the equipment no longer being compliant with the DFS requirements, -e.g
 - Software and/or firmware provided by the manufacturer but intended for other regulatory regimes;
 - Modified software and/or firmware where the software and/or firmware is available as open-source code,
 - Previous versions of the software and/or firmware: (downgrade).

12. GEO-LOCATION CAPABILITY

12.1 APPLIED PROCEDURES / LIMIT

The geographic location determined by the equipment as defined in clause 4.2.10.2 shall not be accessible to the user.

If the equipment cannot determine the geographic location, it shall operate in a mode compliant with the requirements applicable in any of the geographic locations where the equipment is intended to operate.

12.2 TEST RESULTS

The EUT is in accord with Geo-location capability

13 TEST RESULTS

13.1 Occupied Channel Bandwidth

| Condition | Mode | Frequency (MHz) | Antenna | Center Frequency (MHz) | OBW (MHz) | Verdict |
|-----------|------|-----------------|---------|------------------------|-----------|---------|
| NVNT | a | 5180 | Ant1 | 5179.984 | 16.334 | Pass |
| NVNT | n20 | 5180 | Ant1 | 5179.982 | 17.538 | Pass |
| NVNT | n40 | 5190 | Ant1 | 5189.98 | 35.892 | Pass |
| NVNT | ac20 | 5180 | Ant1 | 5179.978 | 17.538 | Pass |
| NVNT | ac40 | 5190 | Ant1 | 5189.996 | 35.876 | Pass |
| NVNT | ac80 | 5210 | Ant1 | 5210.016 | 75.256 | Pass |

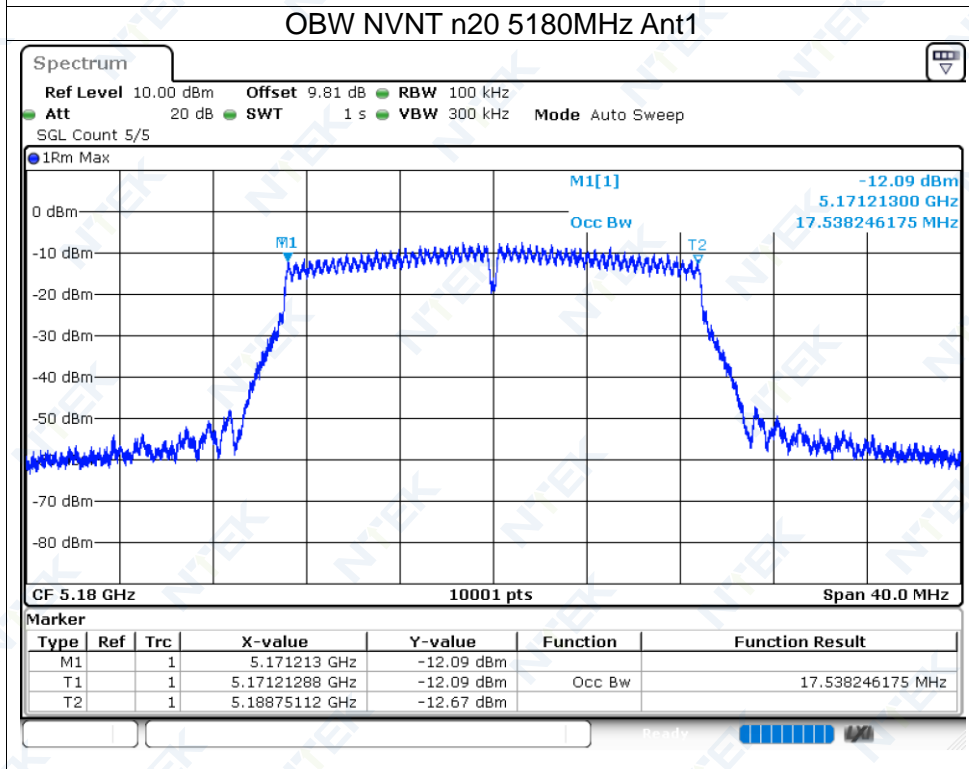
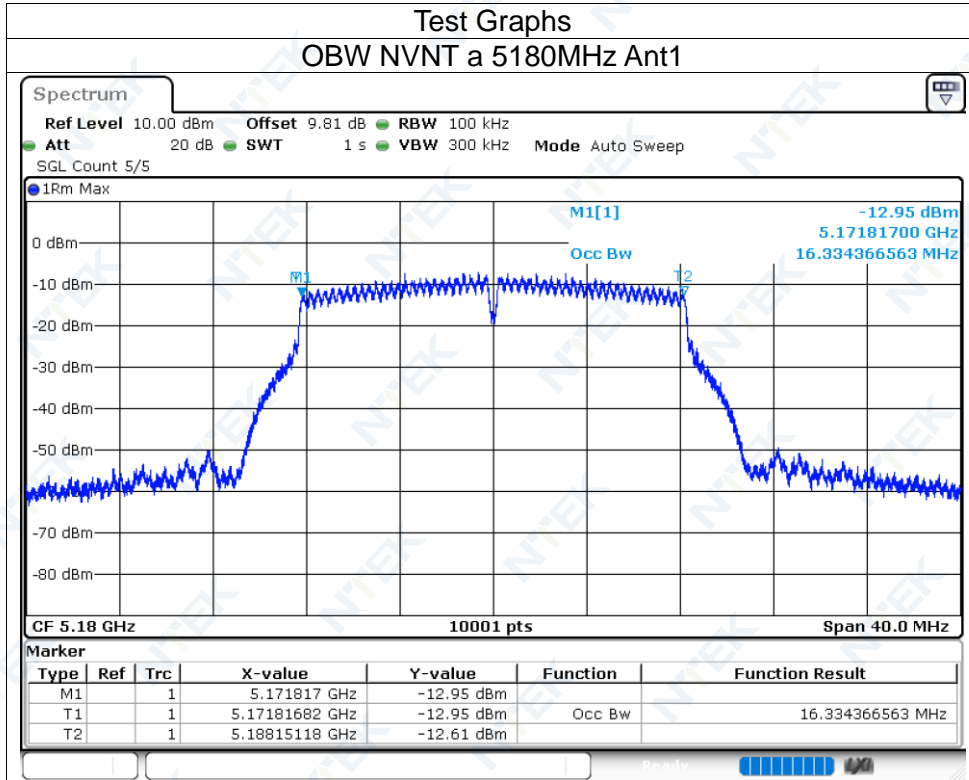

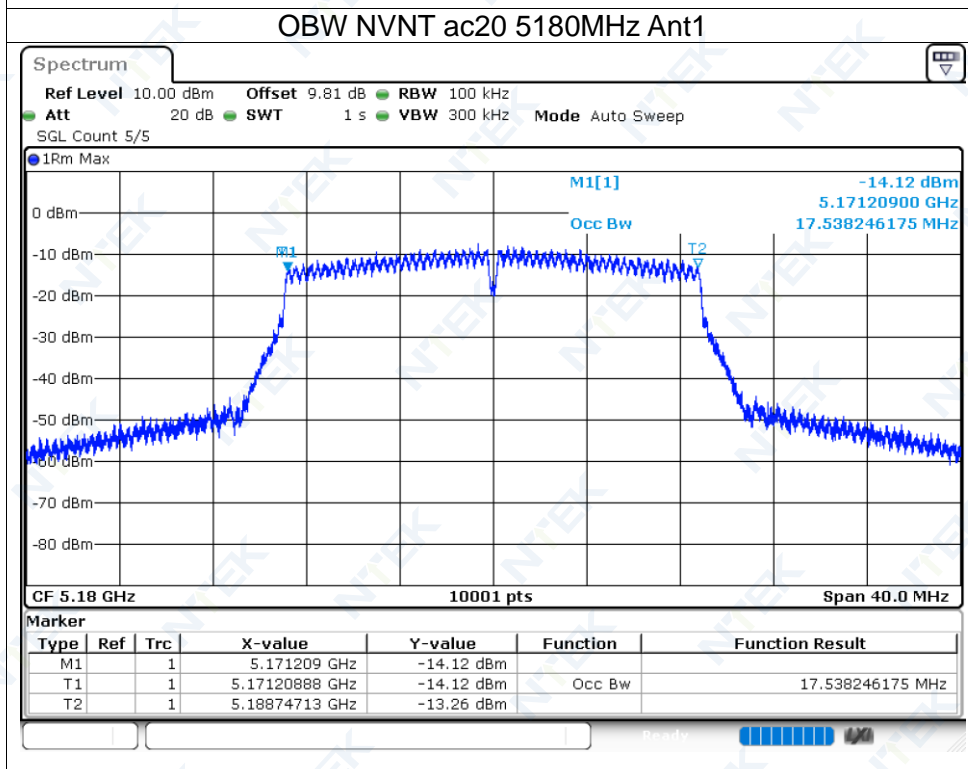
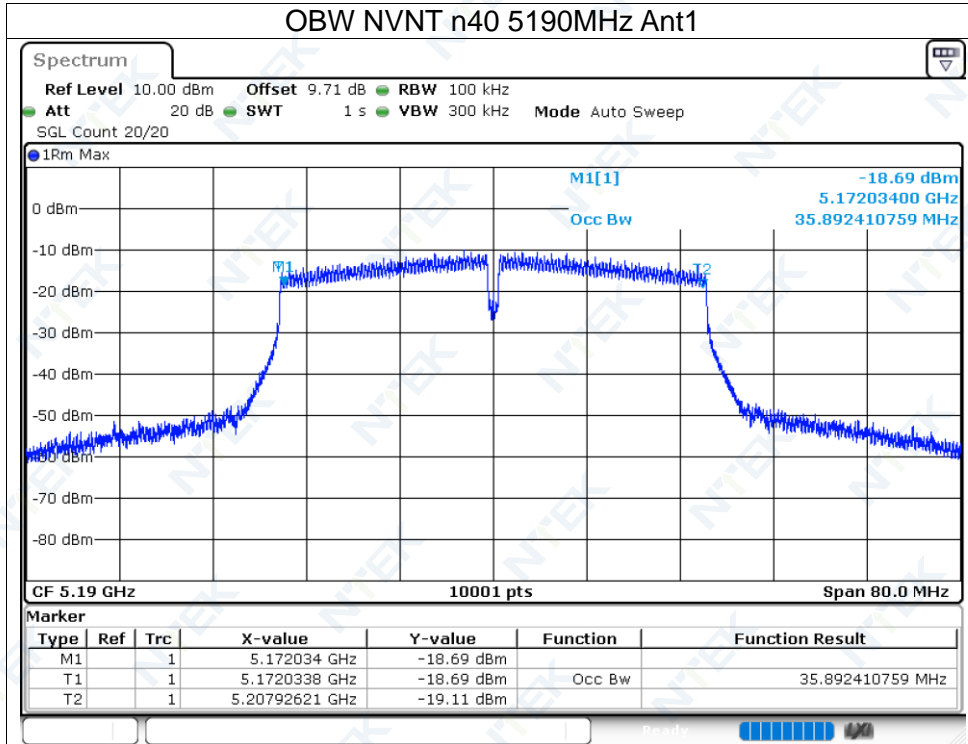

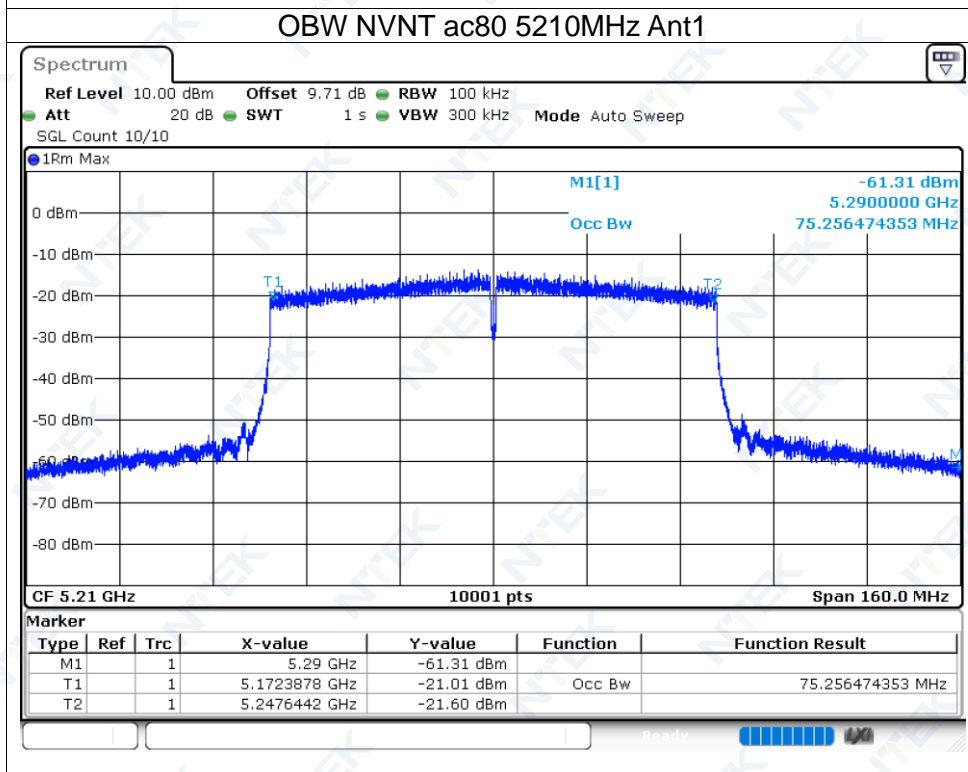
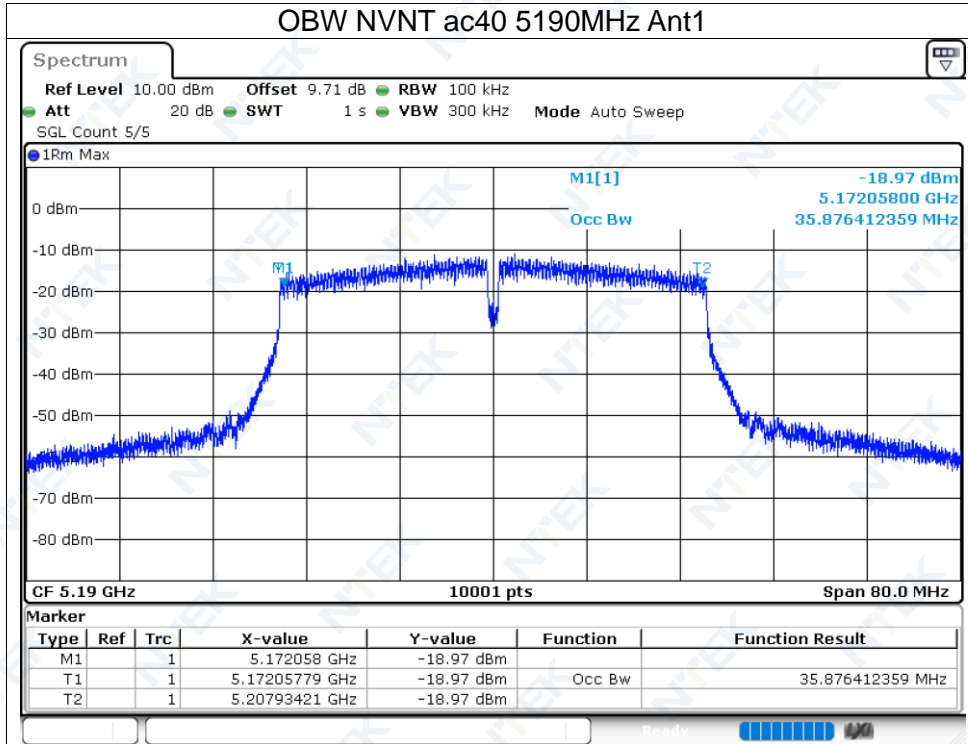

13.2 RF Output Power

| Antenna | Condition | Mode | Frequency (MHz) | Max Burst RMS Power (dBm) | Burst Number | Max EIRP (dBm) | Limit (dBm) | Verdict |
|---------|-----------|------|--------------------|---------------------------------|-----------------|-------------------|-------------|---------|
| Ant 1 | NVNT | a | 5180 | 8.75 | 73 | 9.95 | 23 | Pass |
| Ant 1 | NVNT | n20 | 5180 | 8.62 | 77 | 9.82 | 23 | Pass |
| Ant 1 | NVNT | n40 | 5190 | 8.68 | 151 | 9.88 | 23 | Pass |
| Ant 1 | NVNT | ac20 | 5180 | 8.19 | 77 | 9.39 | 23 | Pass |
| Ant 1 | NVNT | ac40 | 5190 | 8.22 | 149 | 9.42 | 23 | Pass |
| Ant 1 | NVNT | ac80 | 5210 | 8.44 | 286 | 9.64 | 23 | Pass |
| Ant 1 | LTNV | a | 5180 | 8.63 | 104 | 9.83 | 23 | Pass |
| Ant 1 | LTNV | n20 | 5180 | 8.38 | 104 | 9.58 | 23 | Pass |
| Ant 1 | LTNV | n40 | 5190 | 8.32 | 104 | 9.52 | 23 | Pass |
| Ant 1 | LTNV | ac20 | 5180 | 8.04 | 217 | 9.24 | 23 | Pass |
| Ant 1 | LTNV | ac40 | 5190 | 7.83 | 217 | 9.03 | 23 | Pass |
| Ant 1 | LTNV | ac80 | 5210 | 7.85 | 217 | 9.05 | 23 | Pass |
| Ant 1 | HTNV | a | 5180 | 8.54 | 52 | 9.74 | 23 | Pass |
| Ant 1 | HTNV | n20 | 5180 | 8.21 | 52 | 9.41 | 23 | Pass |
| Ant 1 | HTNV | n40 | 5190 | 8.13 | 52 | 9.33 | 23 | Pass |
| Ant 1 | HTNV | ac20 | 5180 | 7.82 | 105 | 9.02 | 23 | Pass |
| Ant 1 | HTNV | ac40 | 5190 | 7.37 | 105 | 8.57 | 23 | Pass |
| Ant 1 | HTNV | ac80 | 5210 | 7.54 | 105 | 8.74 | 23 | Pass |

Test Graphs

Power NVNT a 5180MHz Ant1

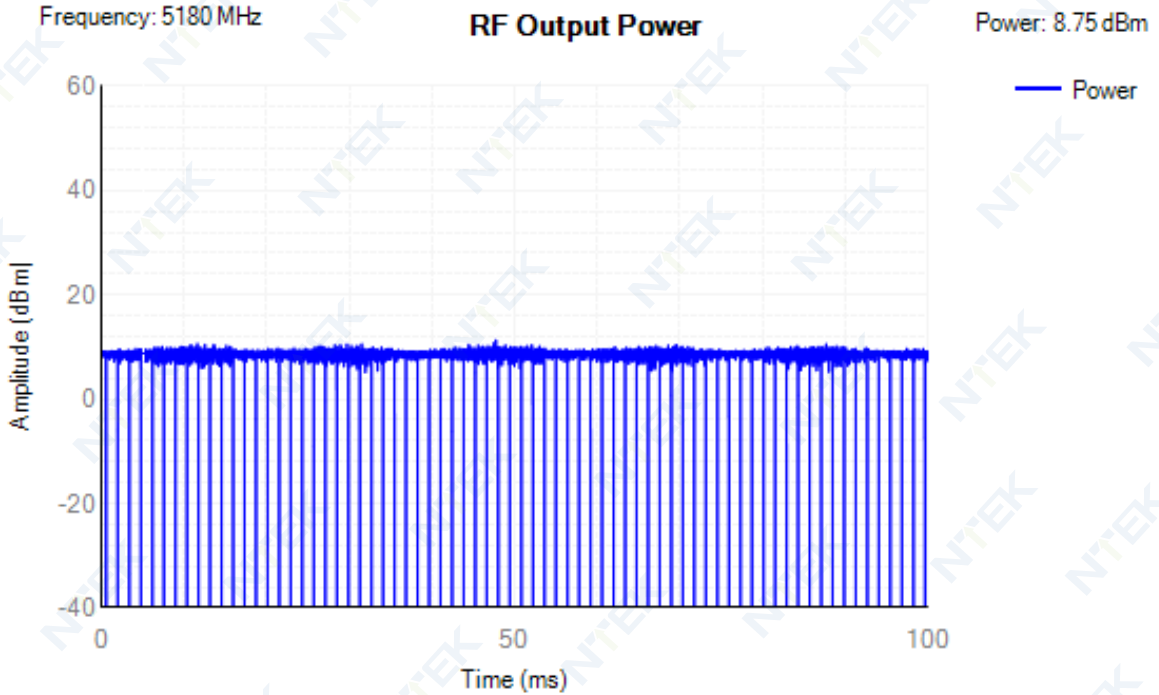

Power NVNT n20 5180MHz Ant1

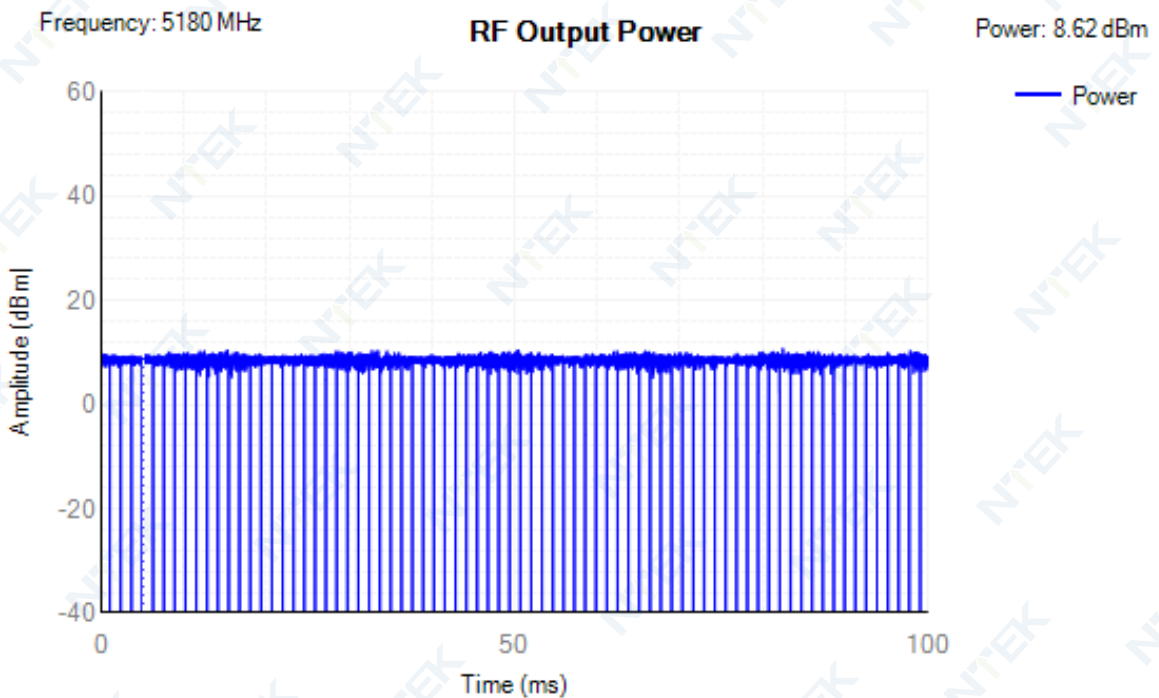

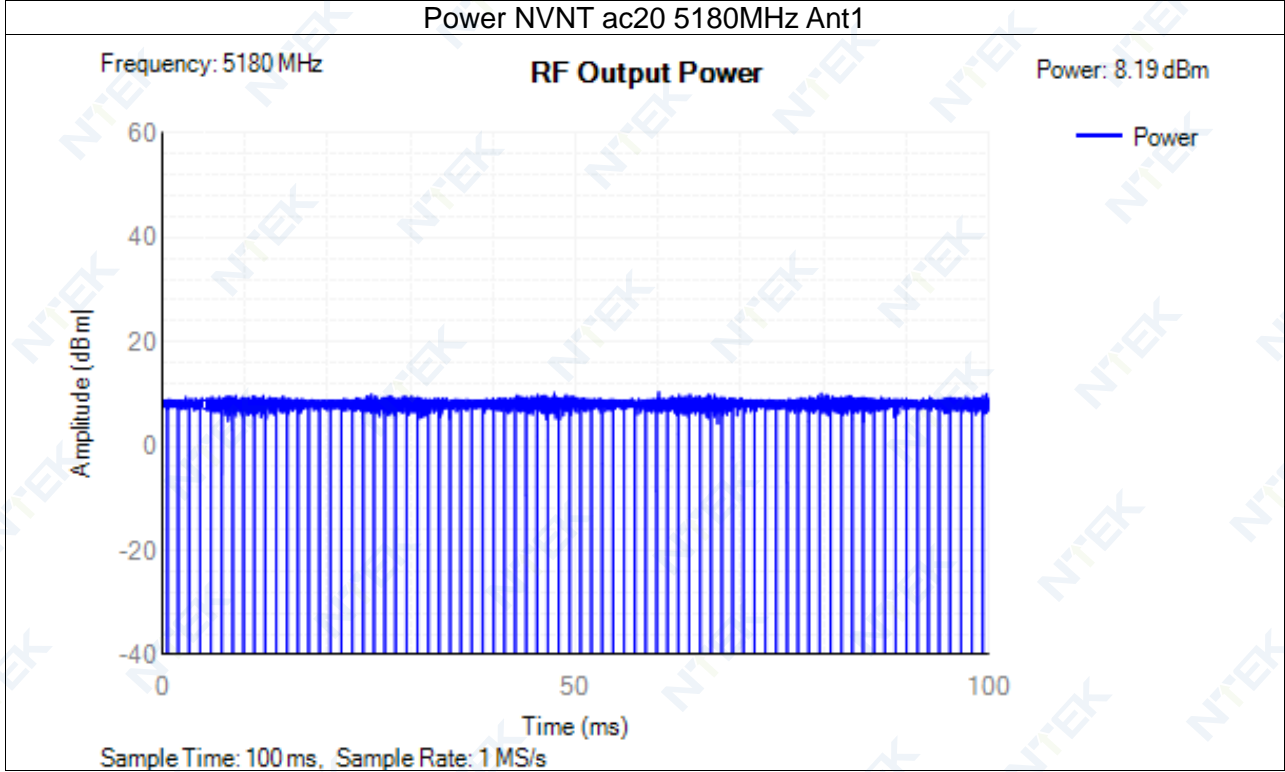
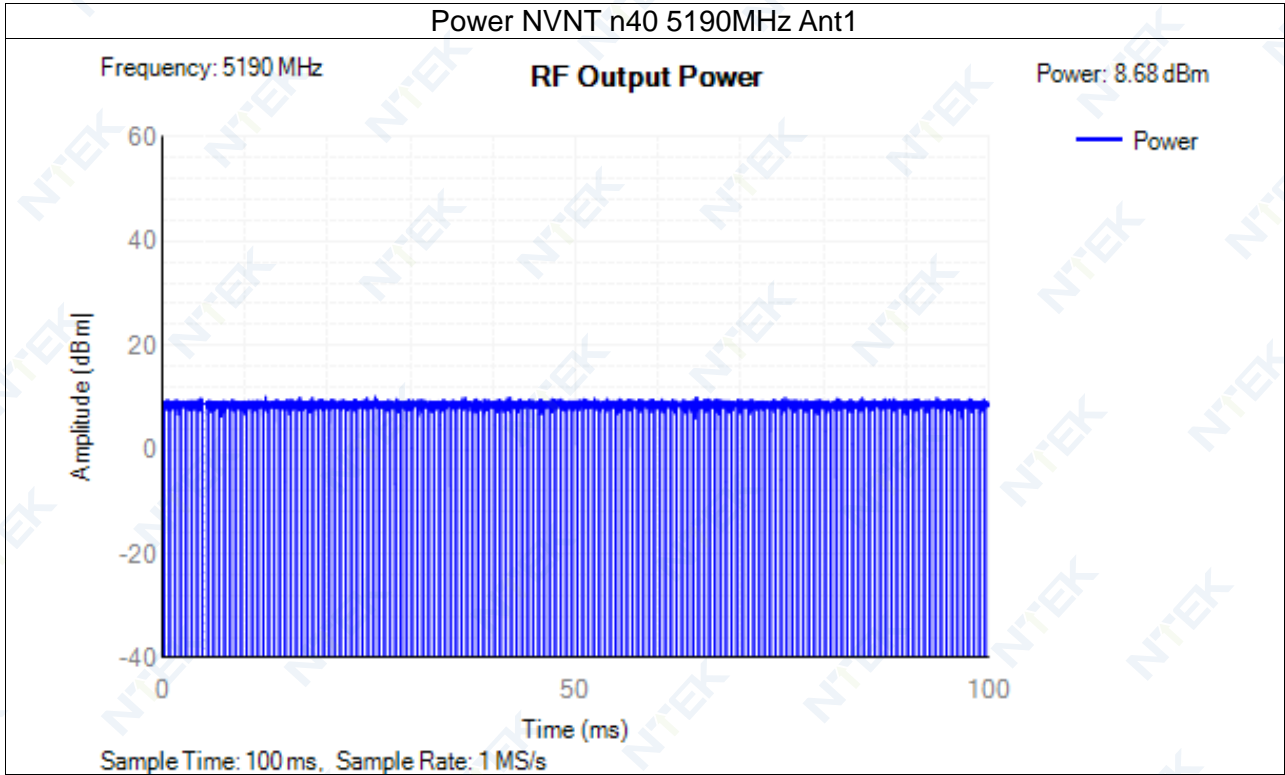

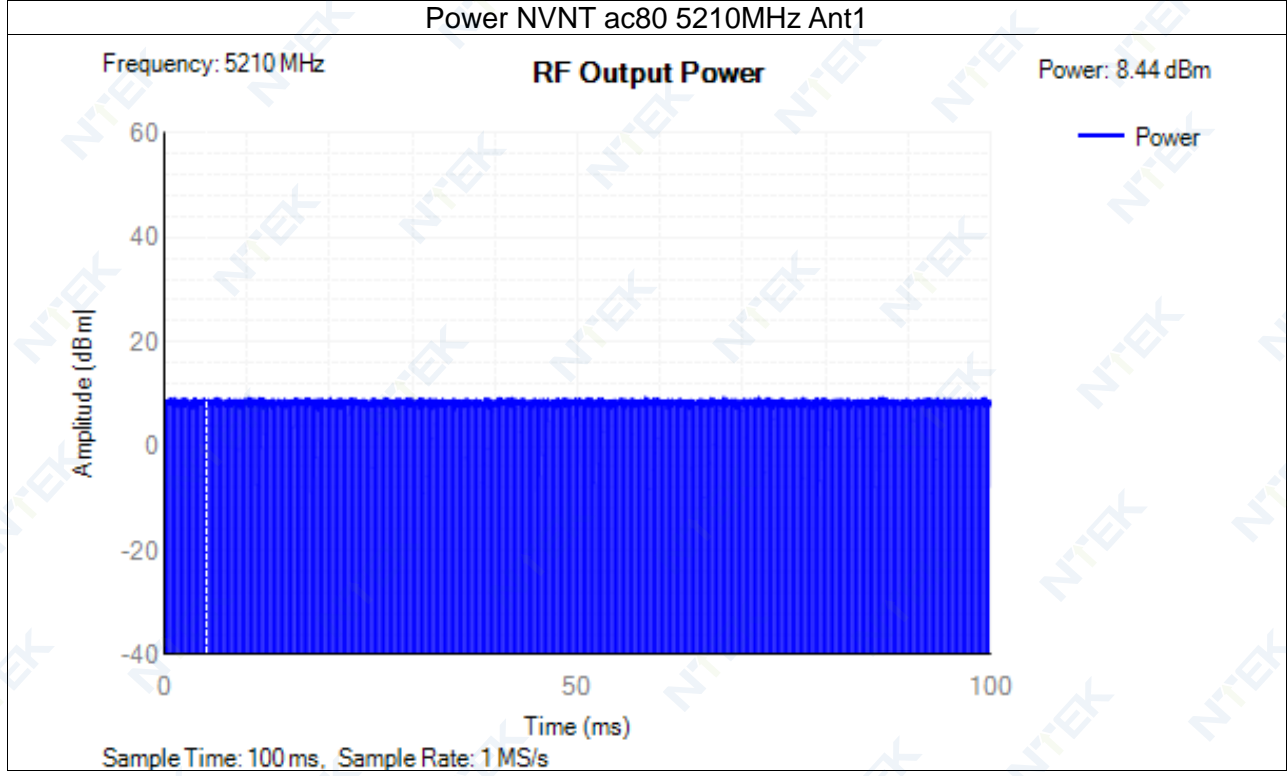
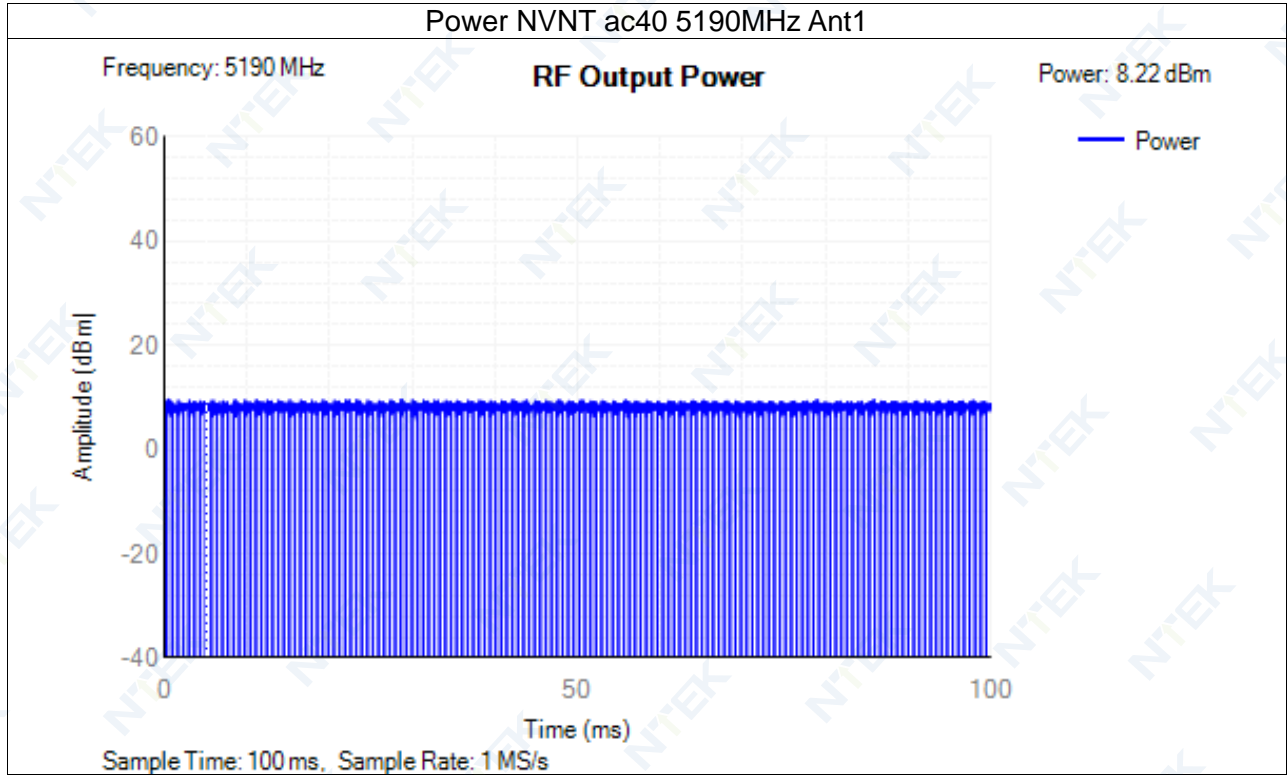

13.3 Power Spectral Density

| Condition | Mode | Frequency (MHz) | Antenna | Max PSD (dBm/MHz) | Limit (dBm/MHz) | Verdict |
|-----------|------|-----------------|---------|-------------------|-----------------|---------|
| NVNT | a | 5180 | Ant1 | -1.01 | 10 | Pass |
| NVNT | n20 | 5180 | Ant1 | -1.77 | 10 | Pass |
| NVNT | n40 | 5190 | Ant1 | -4.5 | 10 | Pass |
| NVNT | ac20 | 5180 | Ant1 | -2.17 | 10 | Pass |
| NVNT | ac40 | 5190 | Ant1 | -5.09 | 10 | Pass |
| NVNT | ac80 | 5210 | Ant1 | -8.16 | 10 | Pass |

Test Graphs

PSD NVNT a 5180MHz Ant1

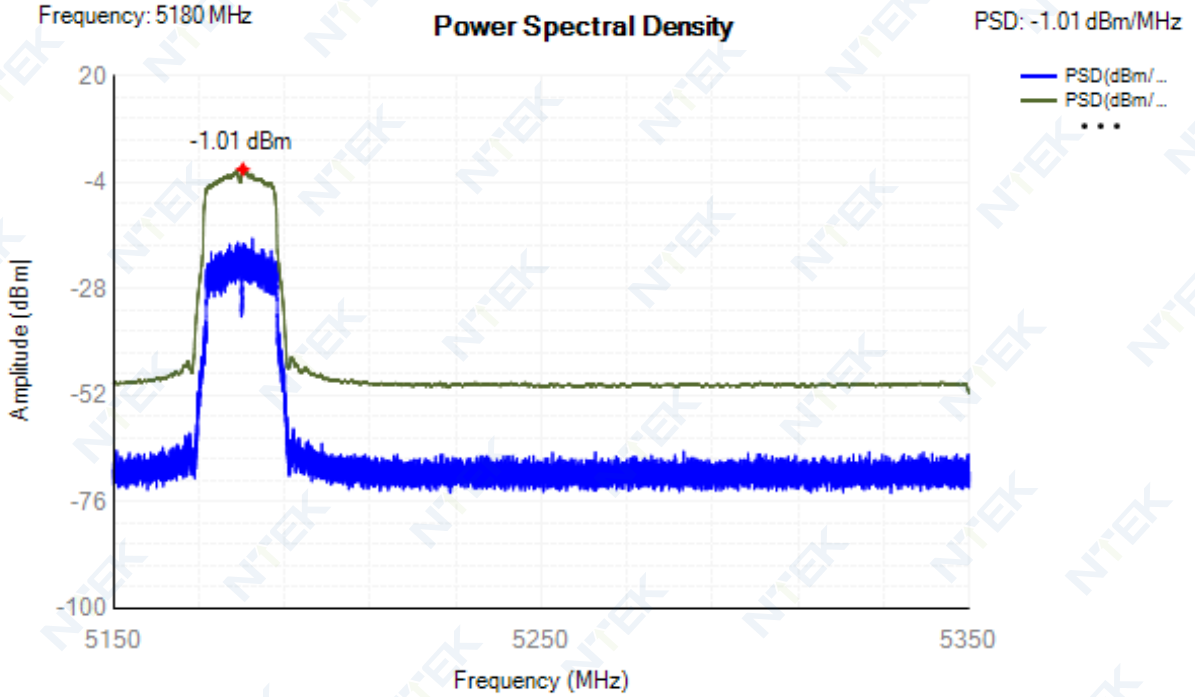

PSD NVNT n20 5180MHz Ant1

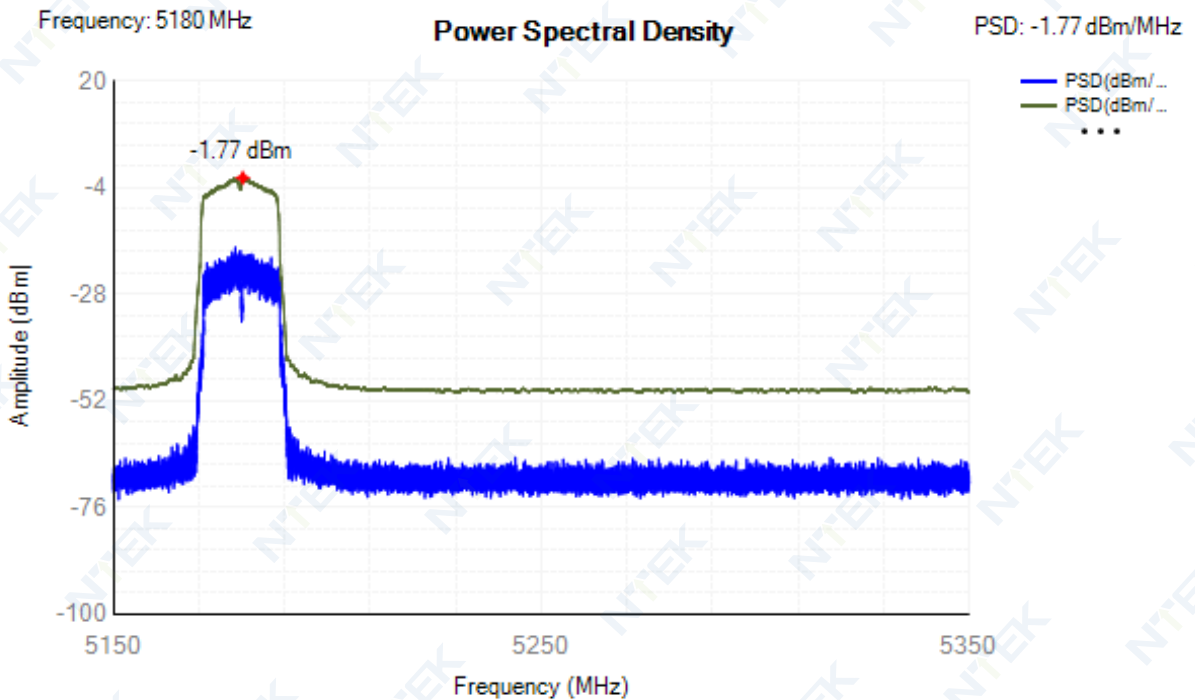

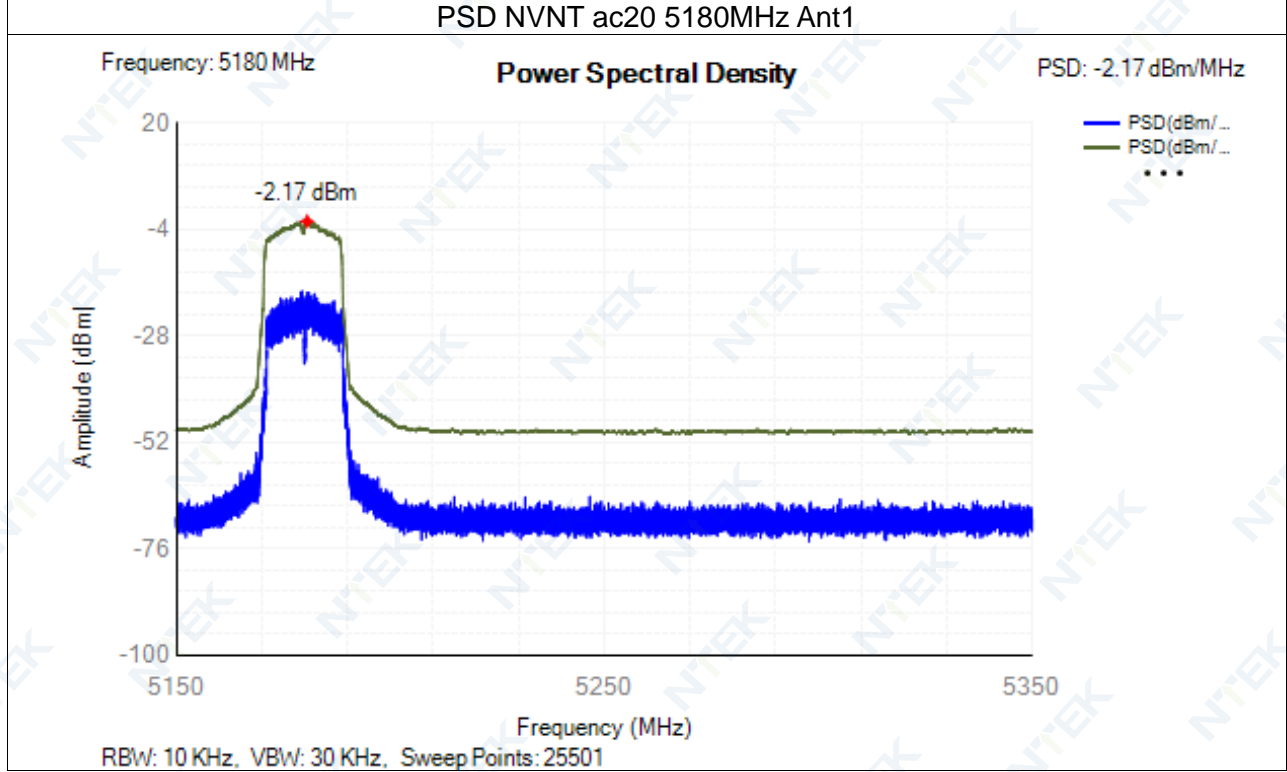
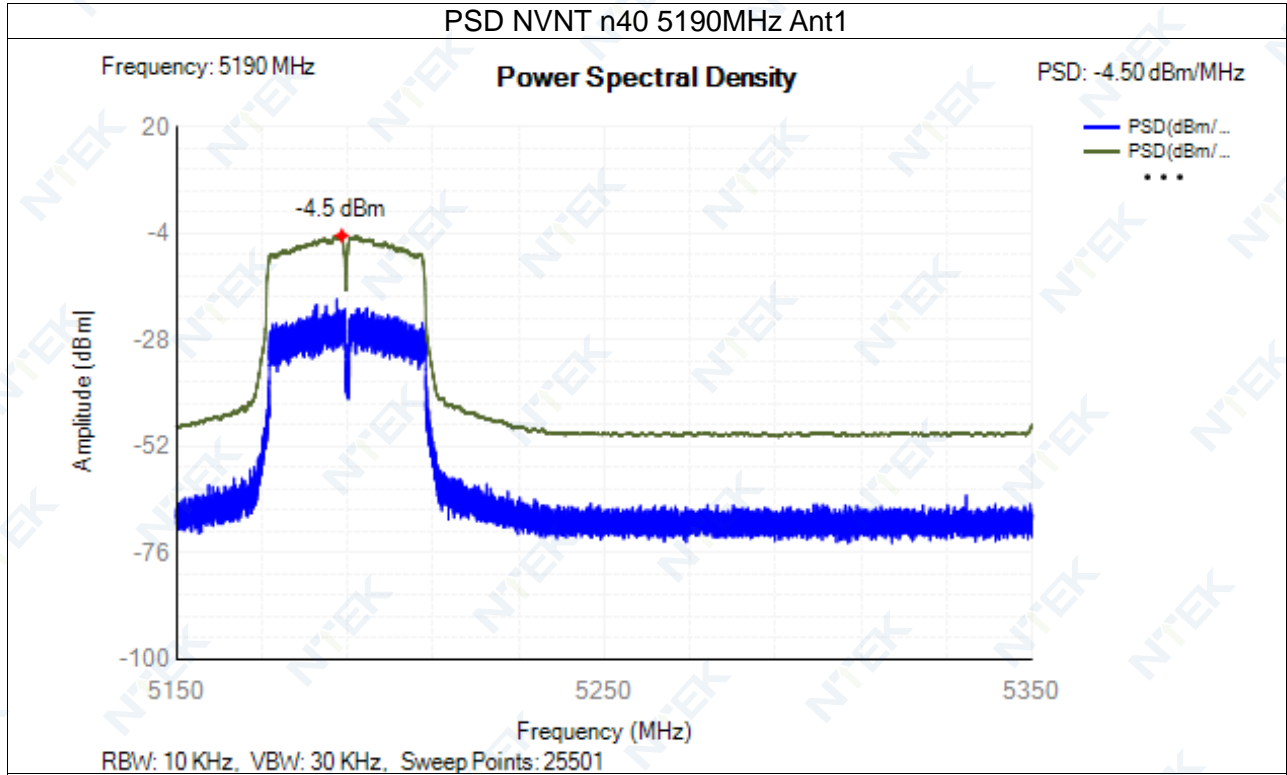

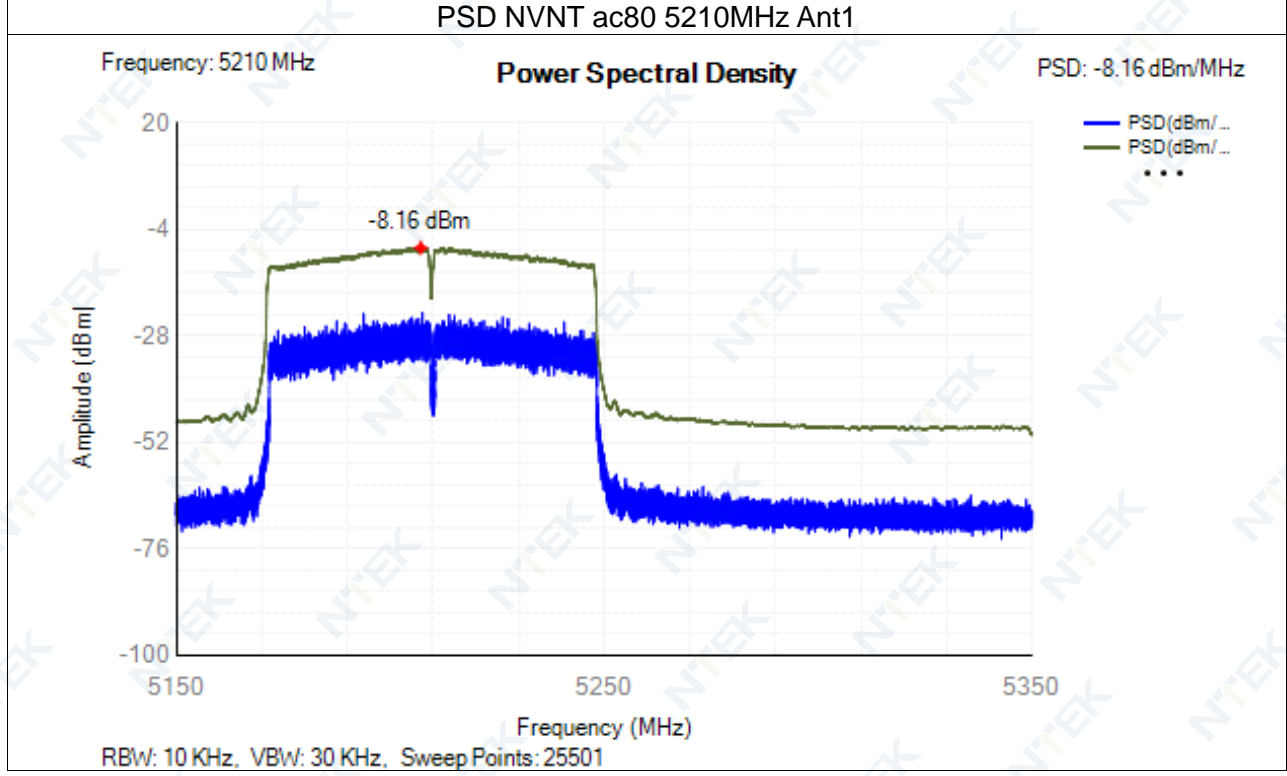
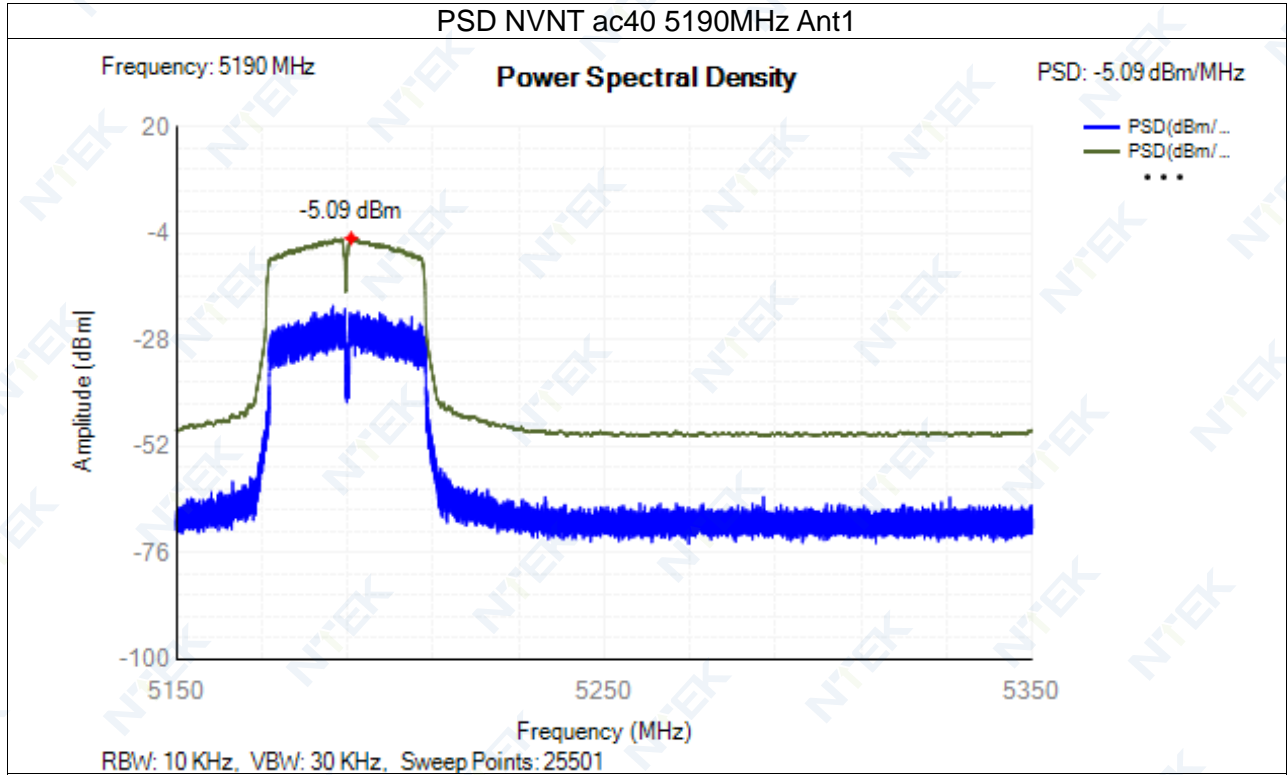

13.4 Transmitter unwanted emissions in the spurious domain

| Condition | Mode | Frequency (MHz) | Antenna | Range (MHz) | Spur Freq (MHz) | Peak (dBm) | RMS (dBm) | Limit (dBm) | Verdict |
|-----------|------|-----------------|---------|-------------|-----------------|------------|-----------|-------------|---------|
| NVNT | a | 5180 | Ant1 | 30 -47 | 35.80 | -75.74 | NA | -36 | Pass |
| NVNT | a | 5180 | Ant1 | 47 -74 | 66.60 | -76.26 | NA | -54 | Pass |
| NVNT | a | 5180 | Ant1 | 74 -87.5 | 82.60 | -75.92 | NA | -36 | Pass |
| NVNT | a | 5180 | Ant1 | 87.5 -118 | 115.30 | -76.03 | NA | -54 | Pass |
| NVNT | a | 5180 | Ant1 | 118 -174 | 167.30 | -74.76 | NA | -36 | Pass |
| NVNT | a | 5180 | Ant1 | 174 -230 | 225.60 | -74.12 | NA | -54 | Pass |
| NVNT | a | 5180 | Ant1 | 230 -470 | 272.50 | -74.02 | NA | -36 | Pass |
| NVNT | a | 5180 | Ant1 | 470 -862 | 798.20 | -74.69 | NA | -54 | Pass |
| NVNT | a | 5180 | Ant1 | 862 -1000 | 974.00 | -66.36 | NA | -36 | Pass |
| NVNT | a | 5180 | Ant1 | 1000 -5150 | 5149.00 | -46.03 | NA | -30 | Pass |
| NVNT | a | 5180 | Ant1 | 5350 -5470 | 5397.00 | -48.38 | NA | -30 | Pass |
| NVNT | a | 5180 | Ant1 | 5725 -26000 | 15949.00 | -43.65 | NA | -30 | Pass |
| NVNT | n20 | 5180 | Ant1 | 30 -47 | 36.10 | -75.31 | NA | -36 | Pass |
| NVNT | n20 | 5180 | Ant1 | 47 -74 | 69.40 | -76.36 | NA | -54 | Pass |
| NVNT | n20 | 5180 | Ant1 | 74 -87.5 | 81.40 | -76.64 | NA | -36 | Pass |
| NVNT | n20 | 5180 | Ant1 | 87.5 -118 | 87.80 | -75.79 | NA | -54 | Pass |
| NVNT | n20 | 5180 | Ant1 | 118 -174 | 165.70 | -75.32 | NA | -36 | Pass |
| NVNT | n20 | 5180 | Ant1 | 174 -230 | 203.50 | -74.33 | NA | -54 | Pass |
| NVNT | n20 | 5180 | Ant1 | 230 -470 | 423.70 | -74.16 | NA | -36 | Pass |
| NVNT | n20 | 5180 | Ant1 | 470 -862 | 849.80 | -74.51 | NA | -54 | Pass |
| NVNT | n20 | 5180 | Ant1 | 862 -1000 | 976.30 | -66.15 | NA | -36 | Pass |
| NVNT | n20 | 5180 | Ant1 | 1000 -5150 | 5137.00 | -46.81 | NA | -30 | Pass |
| NVNT | n20 | 5180 | Ant1 | 5350 -5470 | 5356.00 | -47.80 | NA | -30 | Pass |
| NVNT | n20 | 5180 | Ant1 | 5725 -26000 | 15832.00 | -43.74 | NA | -30 | Pass |
| NVNT | n40 | 5190 | Ant1 | 30 -47 | 45.10 | -76.42 | NA | -36 | Pass |
| NVNT | n40 | 5190 | Ant1 | 47 -74 | 68.10 | -75.81 | NA | -54 | Pass |
| NVNT | n40 | 5190 | Ant1 | 74 -87.5 | 85.30 | -76.02 | NA | -36 | Pass |
| NVNT | n40 | 5190 | Ant1 | 87.5 -118 | 96.40 | -76.19 | NA | -54 | Pass |
| NVNT | n40 | 5190 | Ant1 | 118 -174 | 147.70 | -75.05 | NA | -36 | Pass |
| NVNT | n40 | 5190 | Ant1 | 174 -230 | 211.80 | -73.90 | NA | -54 | Pass |
| NVNT | n40 | 5190 | Ant1 | 230 -470 | 405.50 | -74.17 | NA | -36 | Pass |
| NVNT | n40 | 5190 | Ant1 | 470 -862 | 851.90 | -74.23 | NA | -54 | Pass |
| NVNT | n40 | 5190 | Ant1 | 862 -1000 | 984.50 | -65.30 | NA | -36 | Pass |
| NVNT | n40 | 5190 | Ant1 | 1000 -5150 | 5149.00 | -39.80 | NA | -30 | Pass |
| NVNT | n40 | 5190 | Ant1 | 5350 -5470 | 5366.00 | -48.35 | NA | -30 | Pass |
| NVNT | n40 | 5190 | Ant1 | 5725 -26000 | 15328.00 | -44.17 | NA | -30 | Pass |
| NVNT | ac20 | 5180 | Ant1 | 30 -47 | 37.20 | -76.41 | NA | -36 | Pass |
| NVNT | ac20 | 5180 | Ant1 | 47 -74 | 58.70 | -76.41 | NA | -54 | Pass |
| NVNT | ac20 | 5180 | Ant1 | 74 -87.5 | 87.20 | -76.11 | NA | -36 | Pass |
| NVNT | ac20 | 5180 | Ant1 | 87.5 -118 | 111.00 | -75.92 | NA | -54 | Pass |
| NVNT | ac20 | 5180 | Ant1 | 118 -174 | 133.10 | -75.02 | NA | -36 | Pass |
| NVNT | ac20 | 5180 | Ant1 | 174 -230 | 209.60 | -74.58 | NA | -54 | Pass |
| NVNT | ac20 | 5180 | Ant1 | 230 -470 | 360.20 | -74.58 | NA | -36 | Pass |
| NVNT | ac20 | 5180 | Ant1 | 470 -862 | 706.70 | -75.00 | NA | -54 | Pass |
| NVNT | ac20 | 5180 | Ant1 | 862 -1000 | 974.40 | -67.55 | NA | -36 | Pass |
| NVNT | ac20 | 5180 | Ant1 | 1000 -5150 | 5149.00 | -47.30 | NA | -30 | Pass |
| NVNT | ac20 | 5180 | Ant1 | 5350 -5470 | 5351.00 | -48.63 | NA | -30 | Pass |
| NVNT | ac20 | 5180 | Ant1 | 5725 -26000 | 16272.00 | -43.77 | NA | -30 | Pass |
| NVNT | ac40 | 5190 | Ant1 | 30 -47 | 44.40 | -76.42 | NA | -36 | Pass |
| NVNT | ac40 | 5190 | Ant1 | 47 -74 | 62.30 | -76.52 | NA | -54 | Pass |
| NVNT | ac40 | 5190 | Ant1 | 74 -87.5 | 81.00 | -75.86 | NA | -36 | Pass |
| NVNT | ac40 | 5190 | Ant1 | 87.5 -118 | 104.40 | -75.82 | NA | -54 | Pass |
| NVNT | ac40 | 5190 | Ant1 | 118 -174 | 122.90 | -75.21 | NA | -36 | Pass |
| NVNT | ac40 | 5190 | Ant1 | 174 -230 | 196.70 | -74.75 | NA | -54 | Pass |
| NVNT | ac40 | 5190 | Ant1 | 230 -470 | 335.80 | -74.11 | NA | -36 | Pass |
| NVNT | ac40 | 5190 | Ant1 | 470 -862 | 665.90 | -74.93 | NA | -54 | Pass |
| NVNT | ac40 | 5190 | Ant1 | 862 -1000 | 985.70 | -69.17 | NA | -36 | Pass |
| NVNT | ac40 | 5190 | Ant1 | 1000 -5150 | 5149.00 | -42.67 | NA | -30 | Pass |
| NVNT | ac40 | 5190 | Ant1 | 5350 -5470 | 5390.00 | -48.10 | NA | -30 | Pass |
| NVNT | ac40 | 5190 | Ant1 | 5725 -26000 | 16362.00 | -43.11 | NA | -30 | Pass |
| NVNT | ac80 | 5210 | Ant1 | 30 -47 | 44.50 | -75.18 | NA | -36 | Pass |
| NVNT | ac80 | 5210 | Ant1 | 47 -74 | 50.50 | -75.03 | NA | -54 | Pass |
| NVNT | ac80 | 5210 | Ant1 | 74 -87.5 | 79.60 | -76.12 | NA | -36 | Pass |
| NVNT | ac80 | 5210 | Ant1 | 87.5 -118 | 113.60 | -75.54 | NA | -54 | Pass |
| NVNT | ac80 | 5210 | Ant1 | 118 -174 | 146.50 | -74.80 | NA | -36 | Pass |
| NVNT | ac80 | 5210 | Ant1 | 174 -230 | 214.50 | -75.17 | NA | -54 | Pass |
| NVNT | ac80 | 5210 | Ant1 | 230 -470 | 304.80 | -74.15 | NA | -36 | Pass |
| NVNT | ac80 | 5210 | Ant1 | 470 -862 | 806.80 | -74.20 | NA | -54 | Pass |
| NVNT | ac80 | 5210 | Ant1 | 862 -1000 | 999.60 | -72.37 | NA | -36 | Pass |
| NVNT | ac80 | 5210 | Ant1 | 1000 -5150 | 5146.00 | -39.78 | NA | -30 | Pass |
| NVNT | ac80 | 5210 | Ant1 | 5350 -5470 | 5380.00 | -48.18 | NA | -30 | Pass |
| NVNT | ac80 | 5210 | Ant1 | 5725 -26000 | 16741.00 | -43.81 | NA | -30 | Pass |

Test Graphs

Tx. Spurious NVNT a 5180MHz Ant1

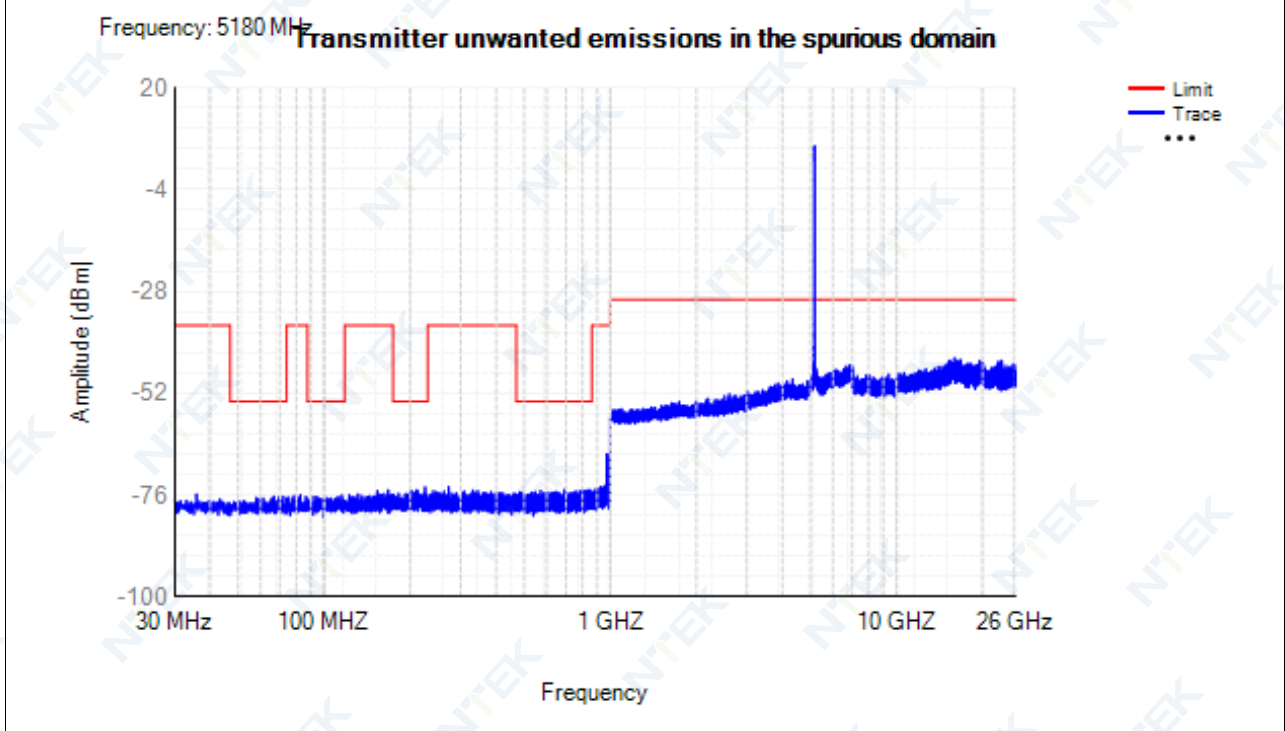

Tx. Spurious NVNT n20 5180MHz Ant1

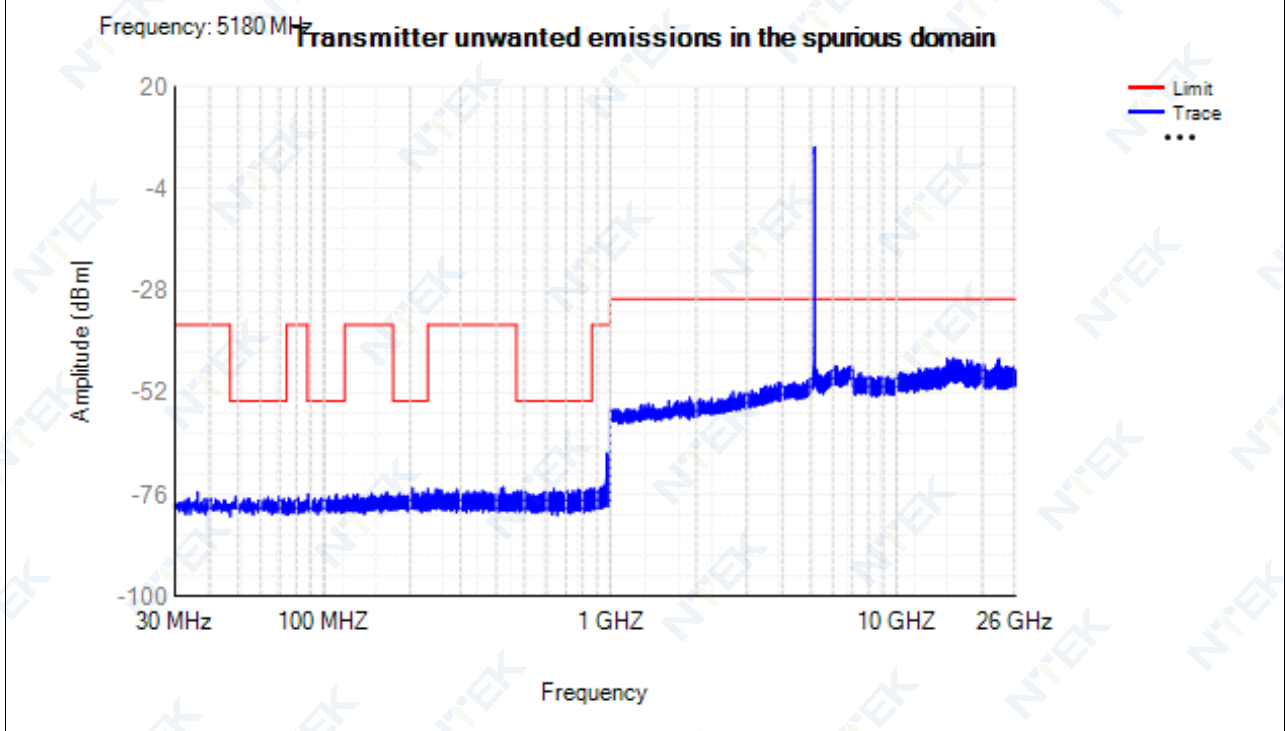

Tx. Spurious NVNT n40 5190MHz Ant1

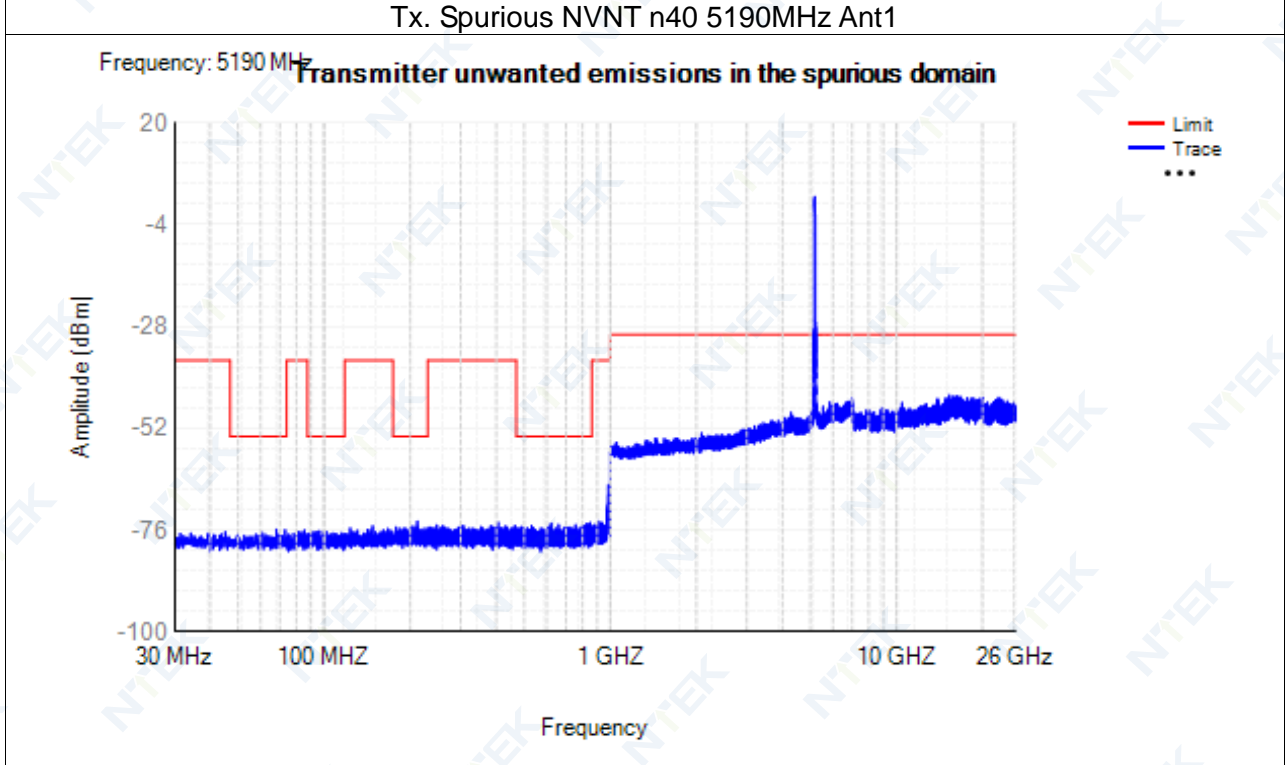

Tx. Spurious NVNT ac20 5180MHz Ant1

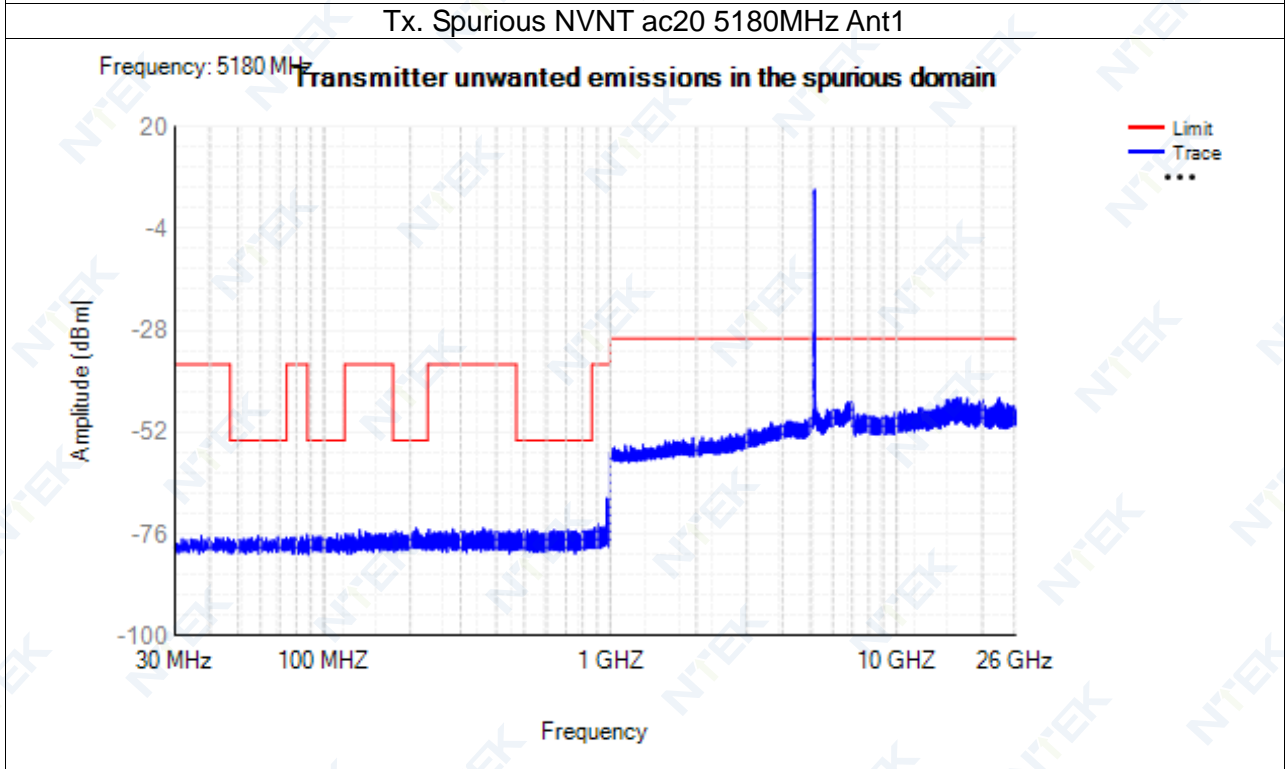

Tx. Spurious NVNT ac40 5190MHz Ant1

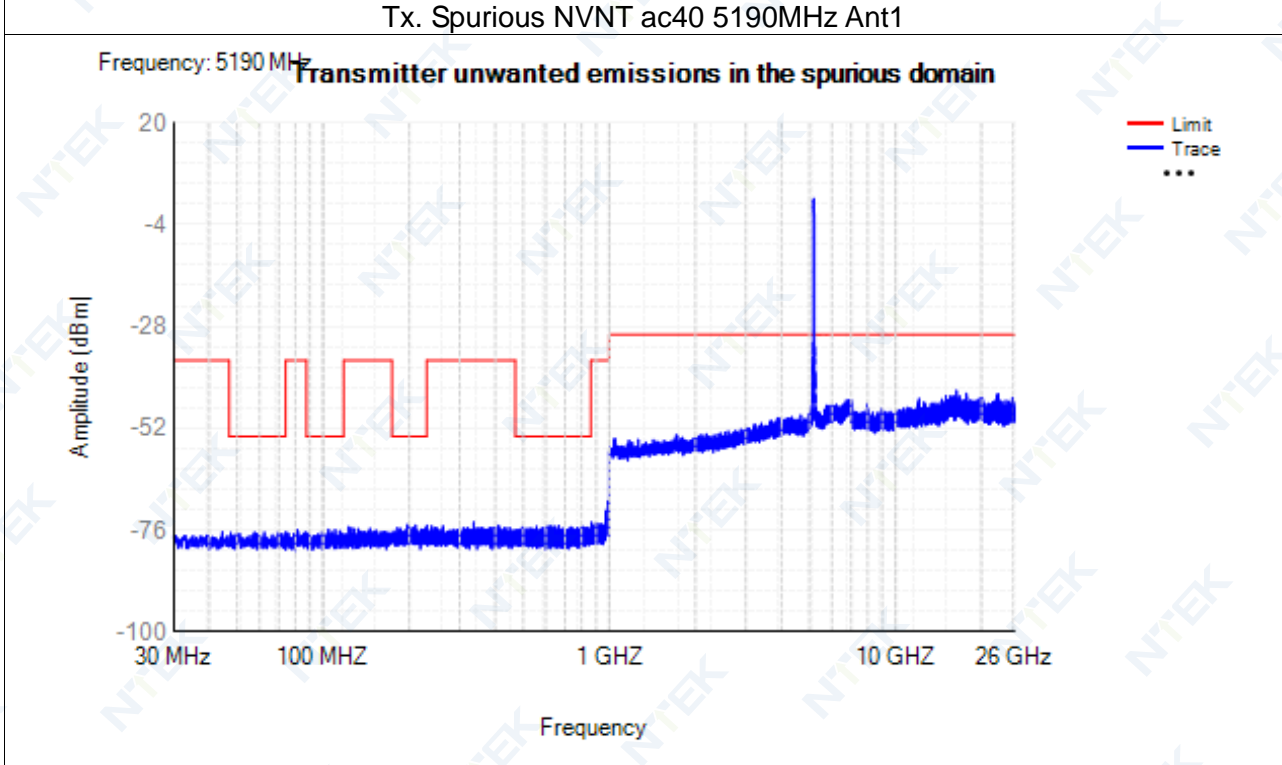

Tx. Spurious NVNT ac80 5210MHz Ant1

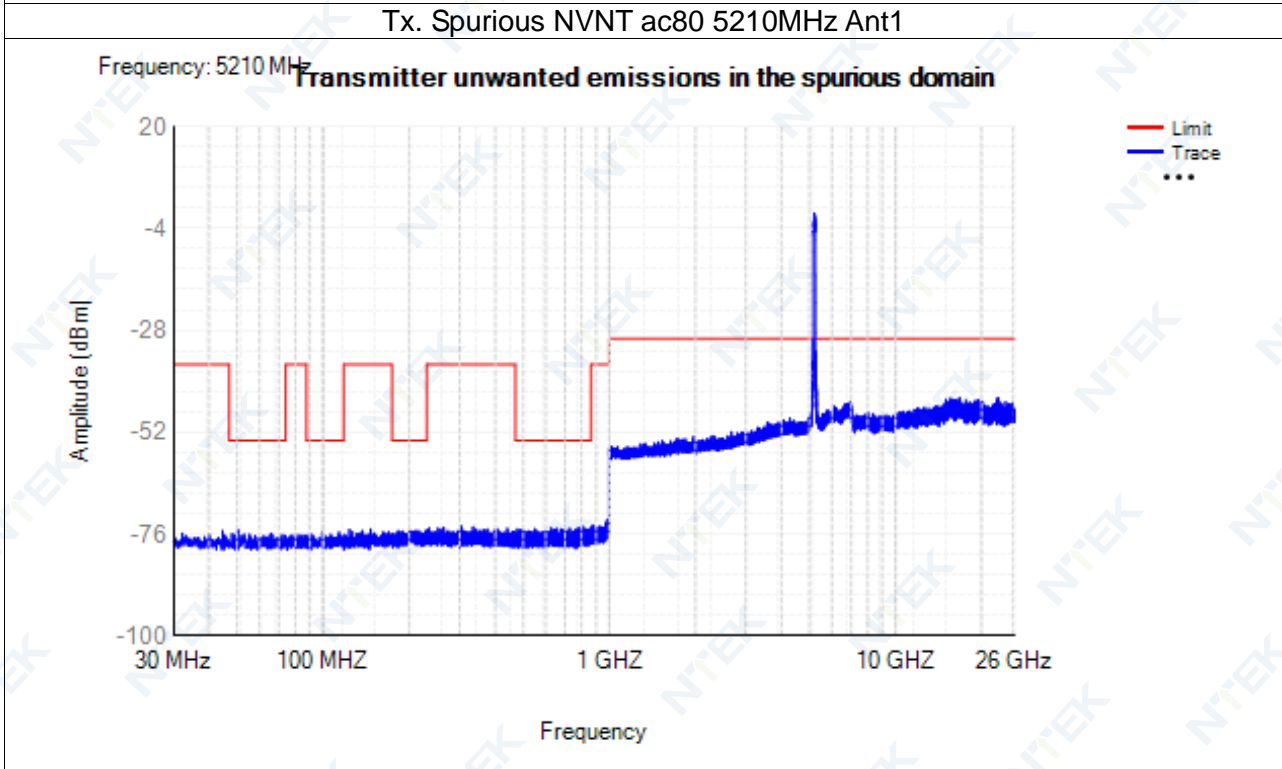

13.5 Transmitter unwanted emissions within the 5 GHz RLAN bands

| Condition | Mode | Frequency (MHz) | Antenna | Sub Band | Worst EIB Frequency (MHz) | Level (dB) | Limit (dB) | Verdict |
|-----------|------|-----------------|---------|----------|---------------------------|------------|------------|---------|
| NVNT | a | 5180 | Ant1 | Band1 | 5209.96 | -55.45 | -39.95 | Pass |
| NVNT | a | 5180 | Ant1 | Band2 | 5470.56 | -65.74 | -47 | Pass |
| NVNT | n20 | 5180 | Ant1 | Band1 | 5210.12 | -53.61 | -40 | Pass |
| NVNT | n20 | 5180 | Ant1 | Band2 | 5720.26 | -56.43 | -47 | Pass |
| NVNT | n40 | 5190 | Ant1 | Band1 | 5251.08 | -51.84 | -40 | Pass |
| NVNT | n40 | 5190 | Ant1 | Band2 | 5720.72 | -53.02 | -47 | Pass |
| NVNT | ac20 | 5180 | Ant1 | Band1 | 5191 | -35.8 | -20 | Pass |
| NVNT | ac20 | 5180 | Ant1 | Band2 | 5471.17 | -64.89 | -47 | Pass |
| NVNT | ac40 | 5190 | Ant1 | Band1 | 5250.48 | -51.58 | -40 | Pass |
| NVNT | ac40 | 5190 | Ant1 | Band2 | 5720.16 | -52.58 | -47 | Pass |
| NVNT | ac80 | 5210 | Ant1 | Band1 | 5330.24 | -49.02 | -40 | Pass |
| NVNT | ac80 | 5210 | Ant1 | Band2 | 5723.93 | -49.07 | -40 | Pass |

Test Graphs

Tx. Emissions EIB NVNT a 5180MHz Sub Band1

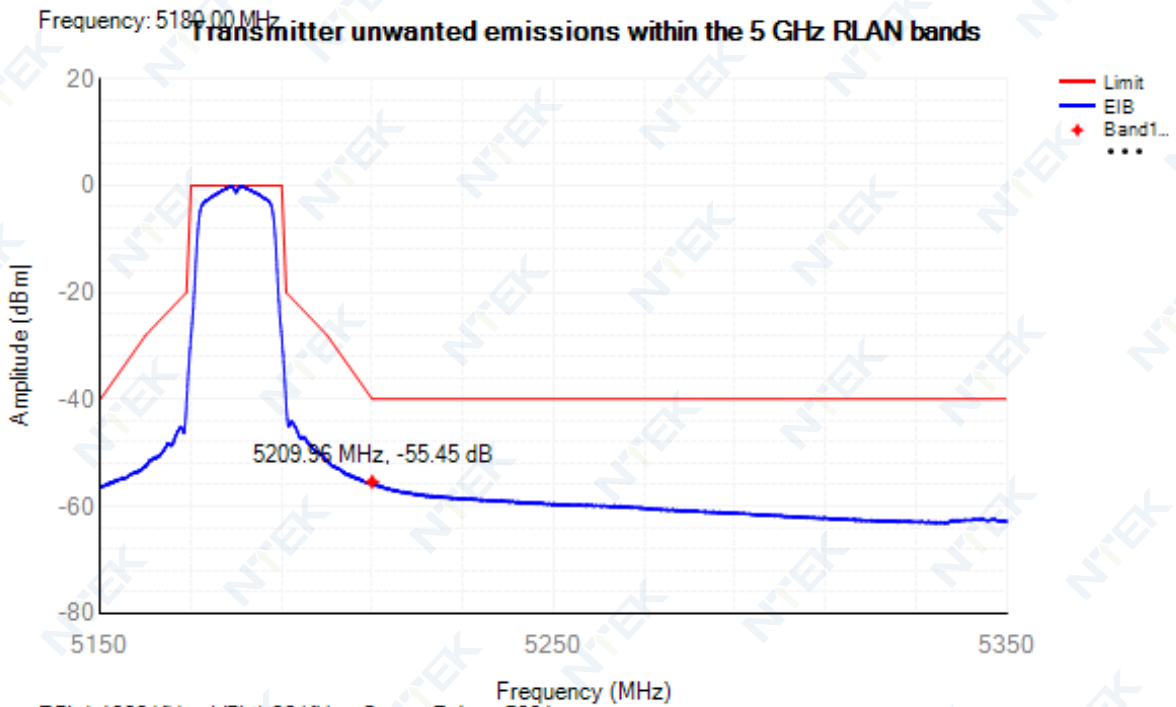

Tx. Emissions EIB NVNT a 5180MHz Sub Band2

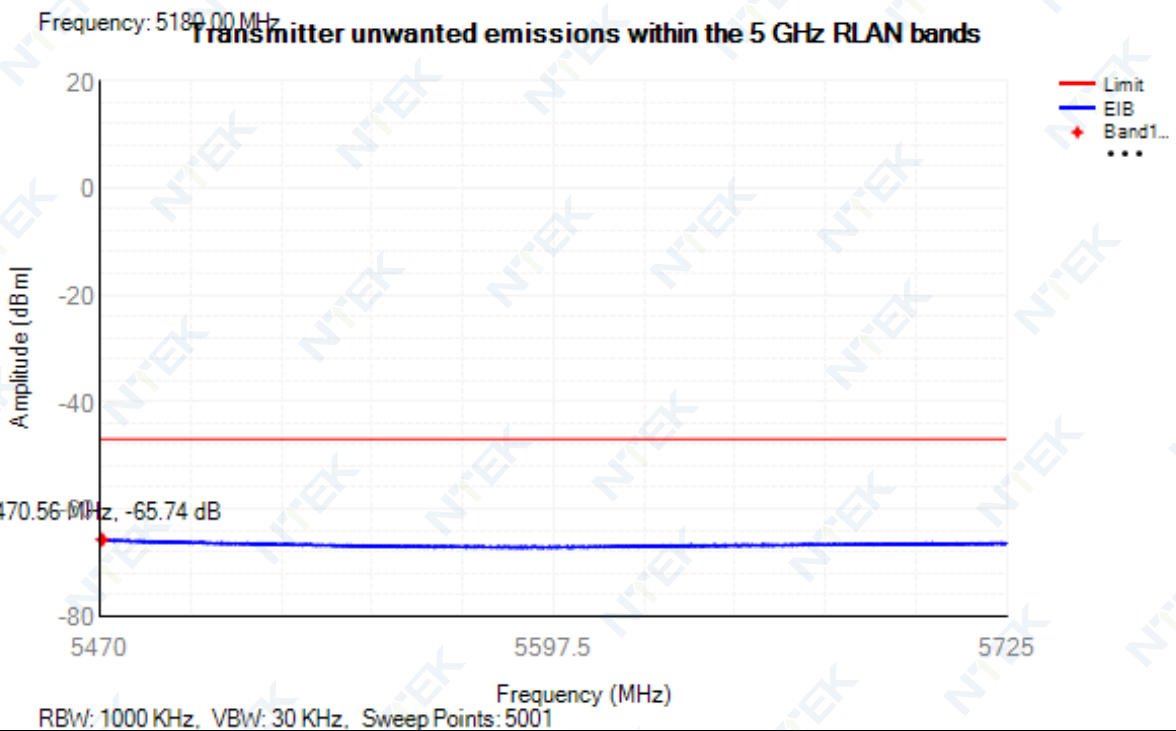

Tx. Emissions EIB NVNT n20 5180MHz Sub Band1

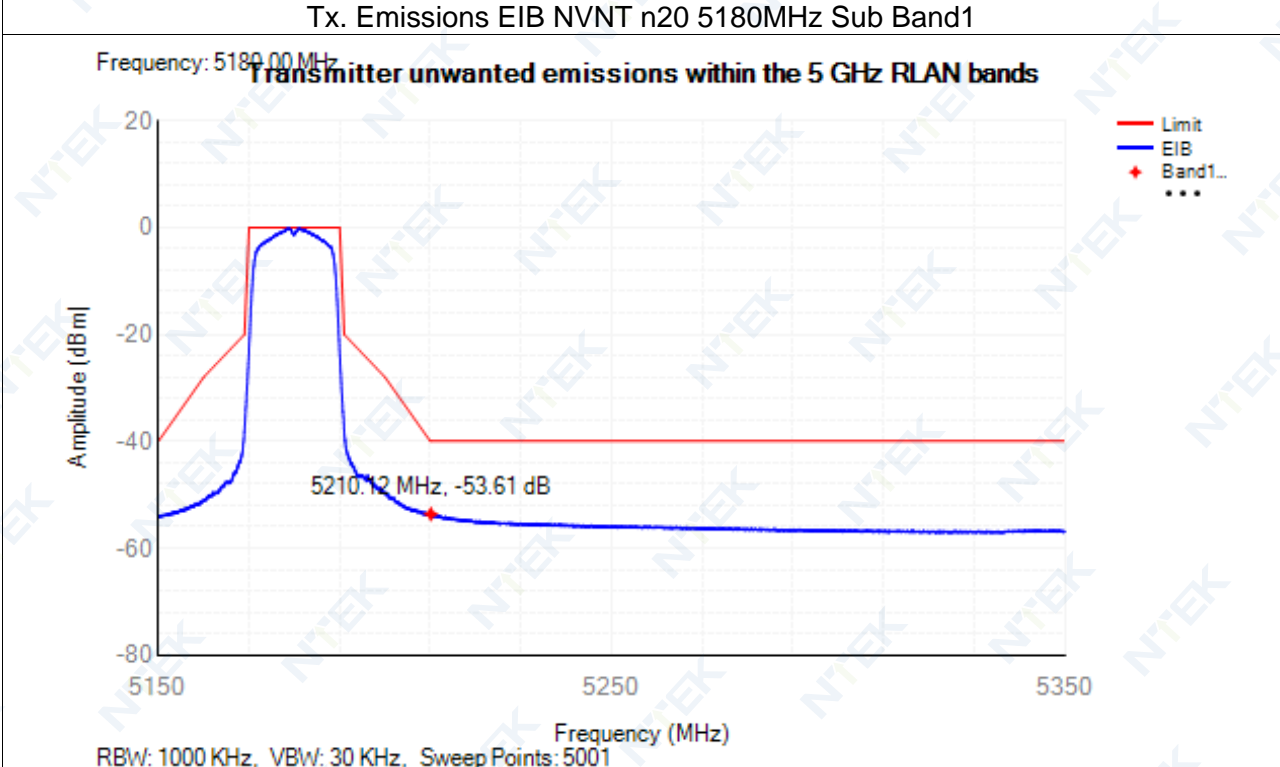

Tx. Emissions EIB NVNT n20 5180MHz Sub Band2

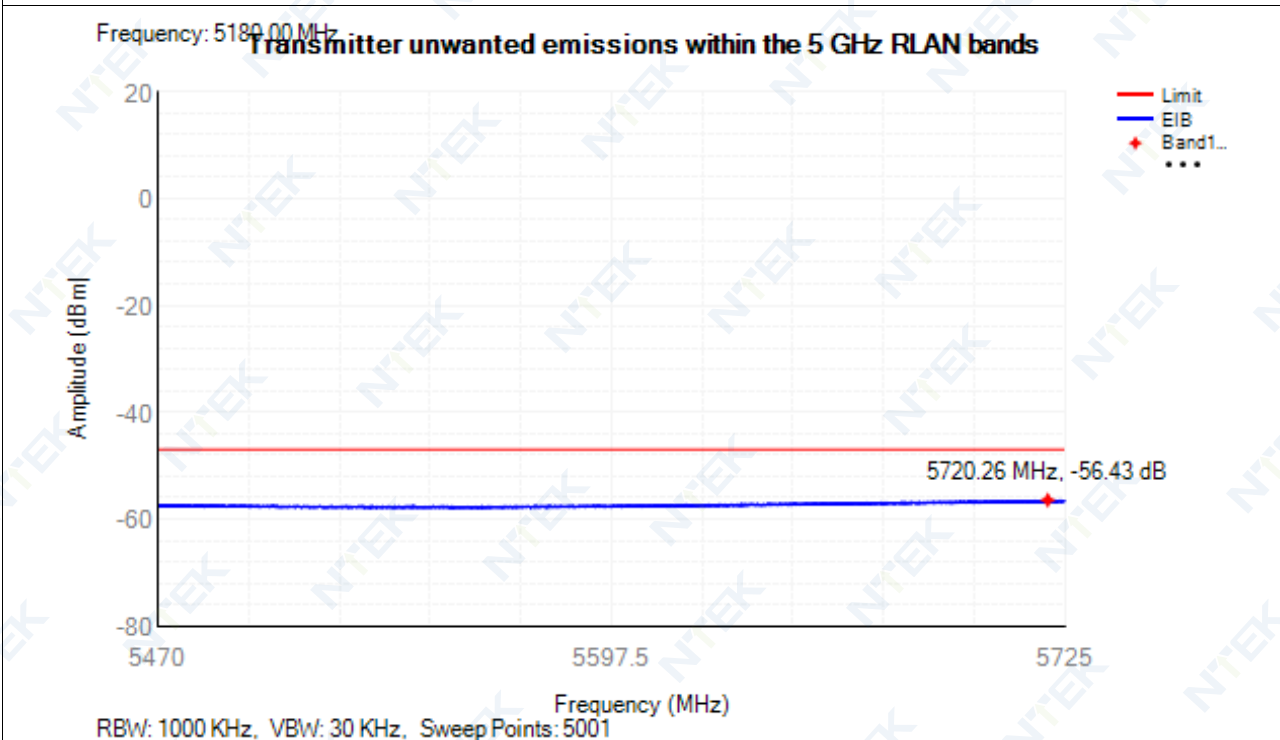

Tx. Emissions EIB NVNT n40 5190MHz Sub Band1

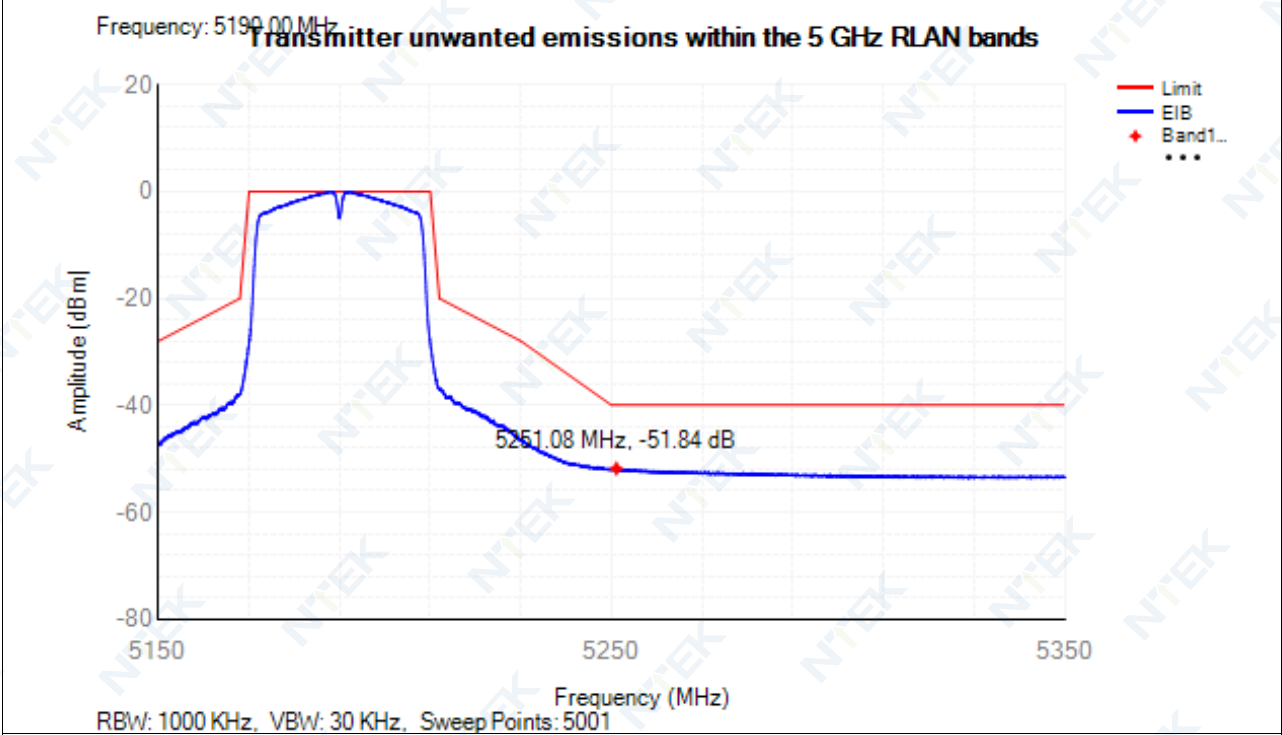

Tx. Emissions EIB NVNT n40 5190MHz Sub Band2

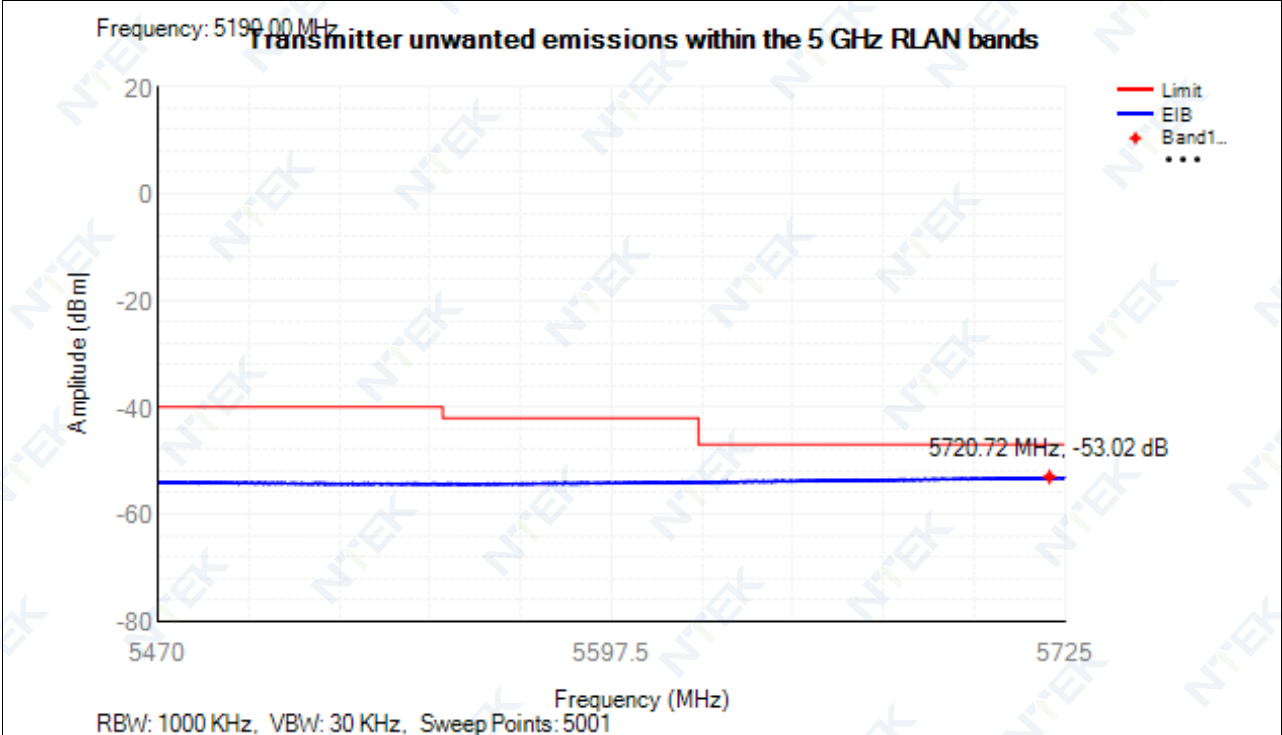

Tx. Emissions EIB NVNT ac20 5180MHz Sub Band1

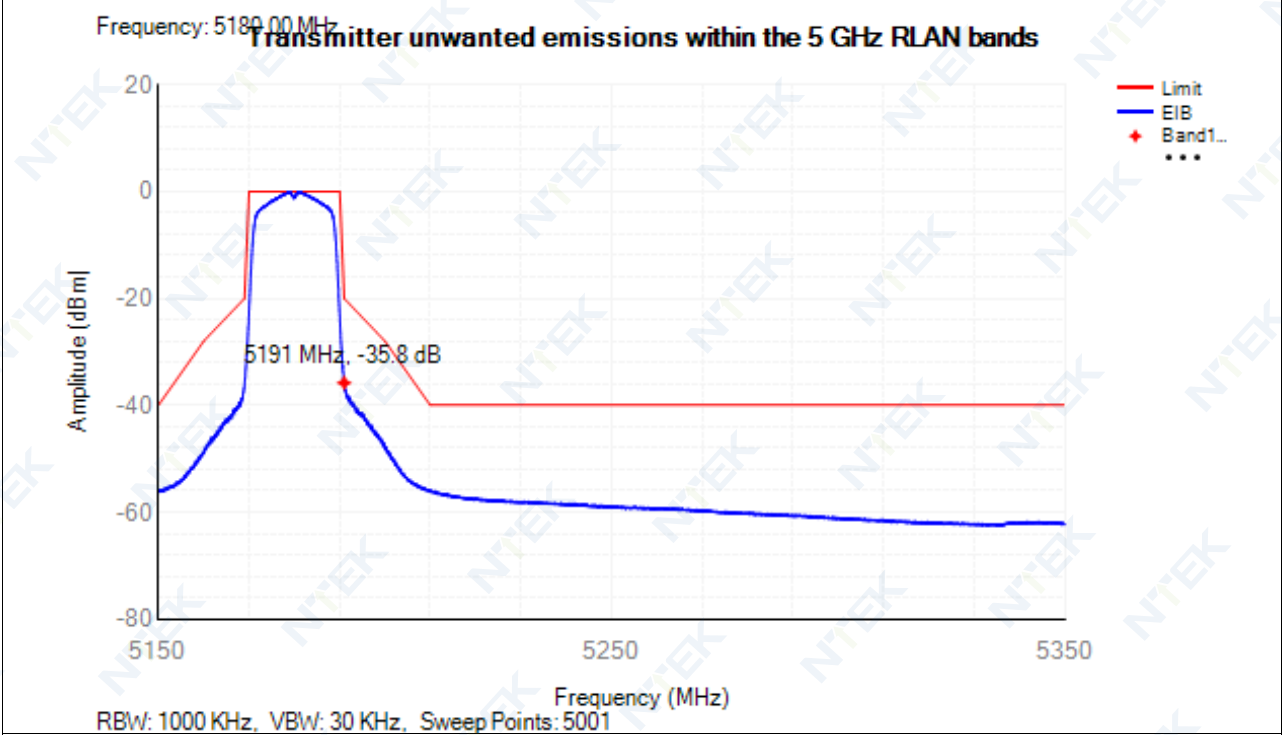

Tx. Emissions EIB NVNT ac20 5180MHz Sub Band2

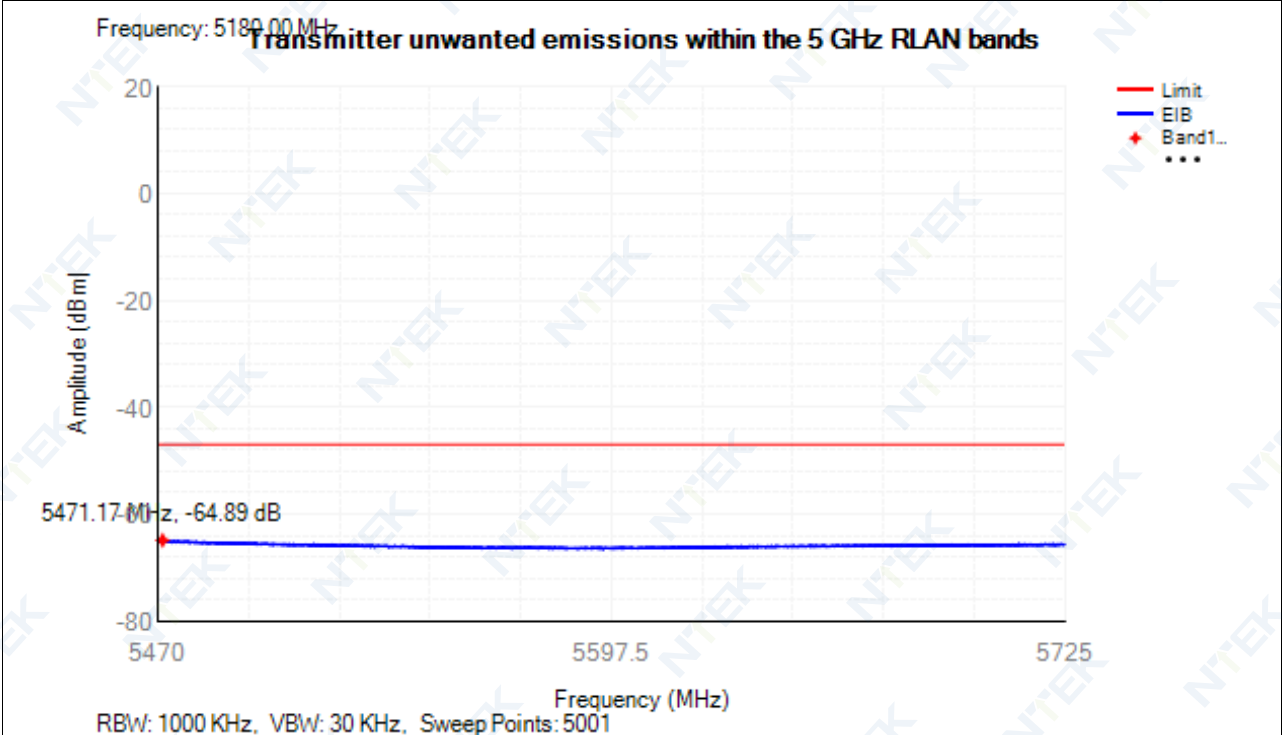

Tx. Emissions EIB NVNT ac40 5190MHz Sub Band1

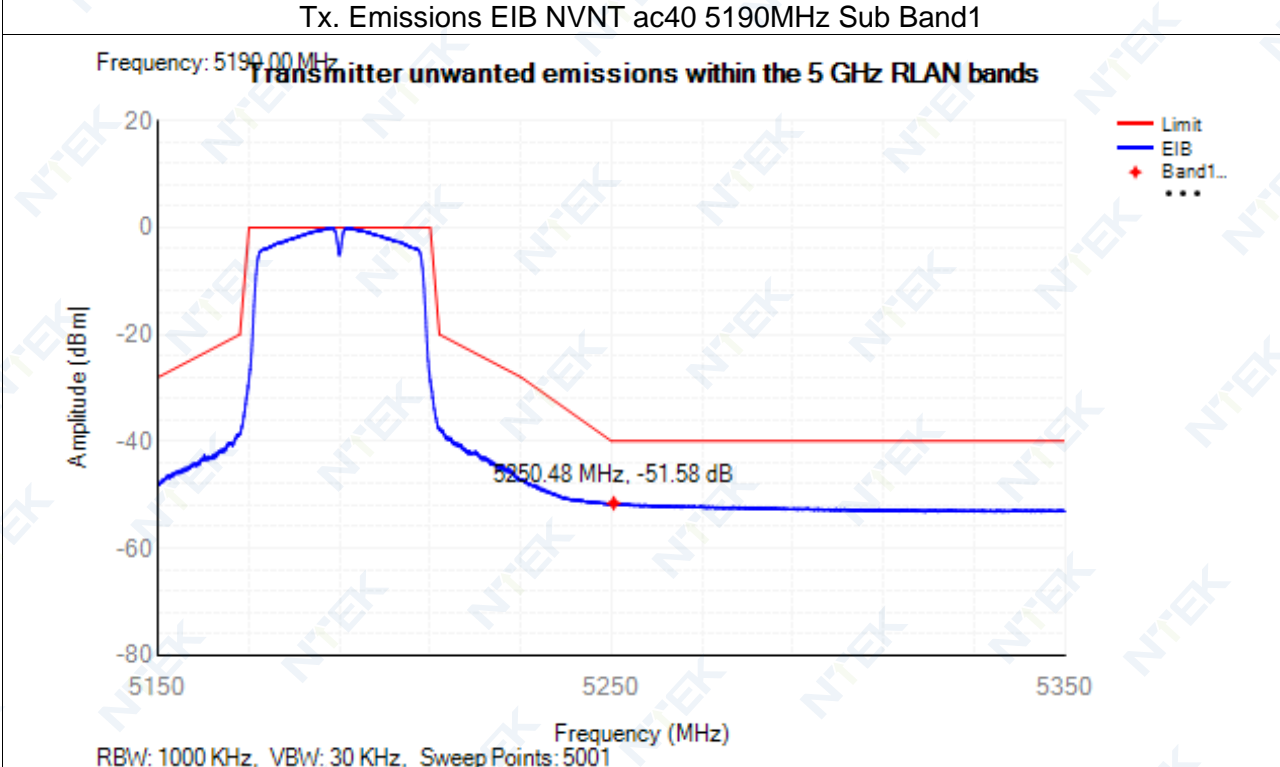

Tx. Emissions EIB NVNT ac40 5190MHz Sub Band2

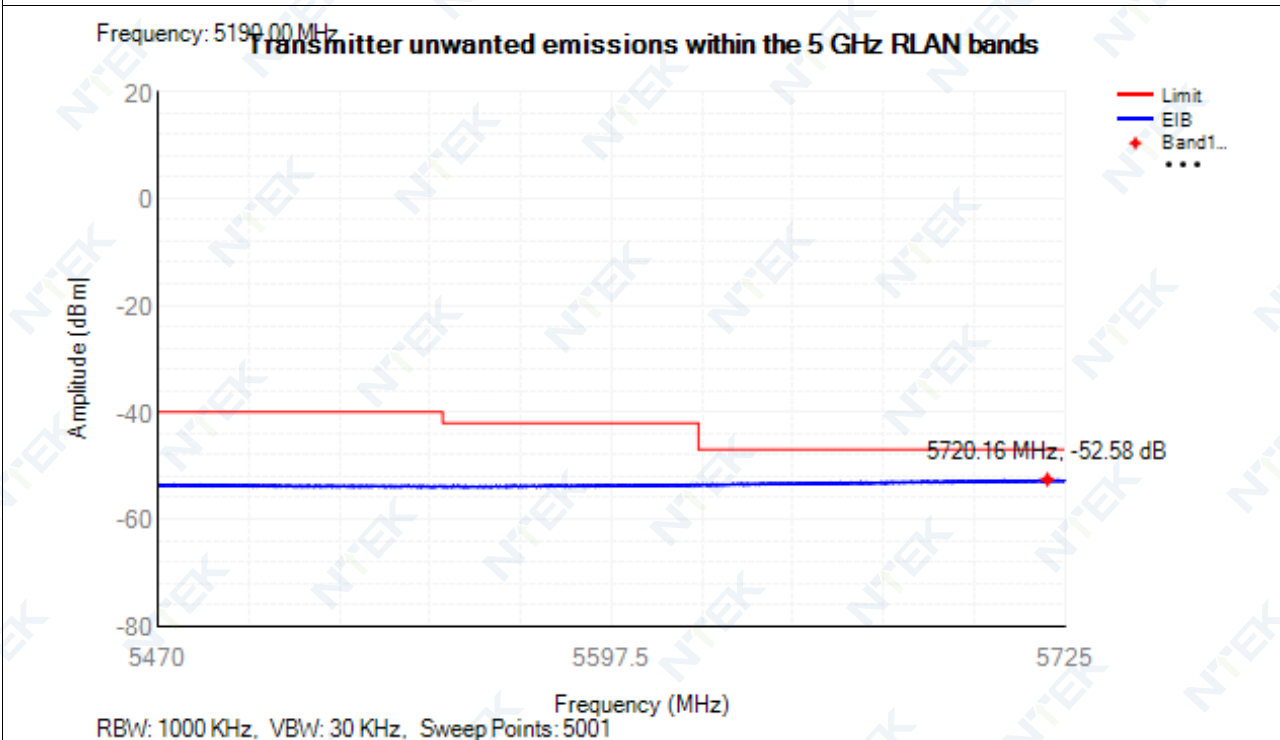

Tx. Emissions EIB NVNT ac80 5210MHz Sub Band1

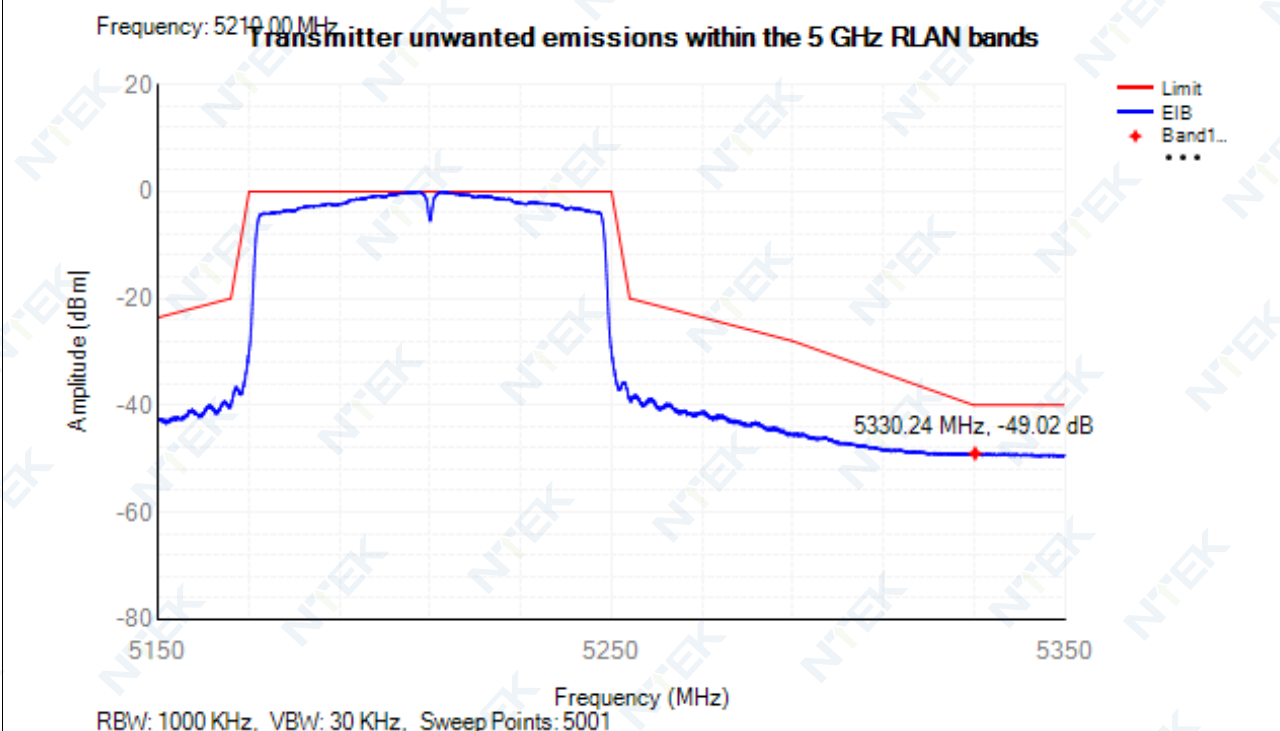

Tx. Emissions EIB NVNT ac80 5210MHz Sub Band2

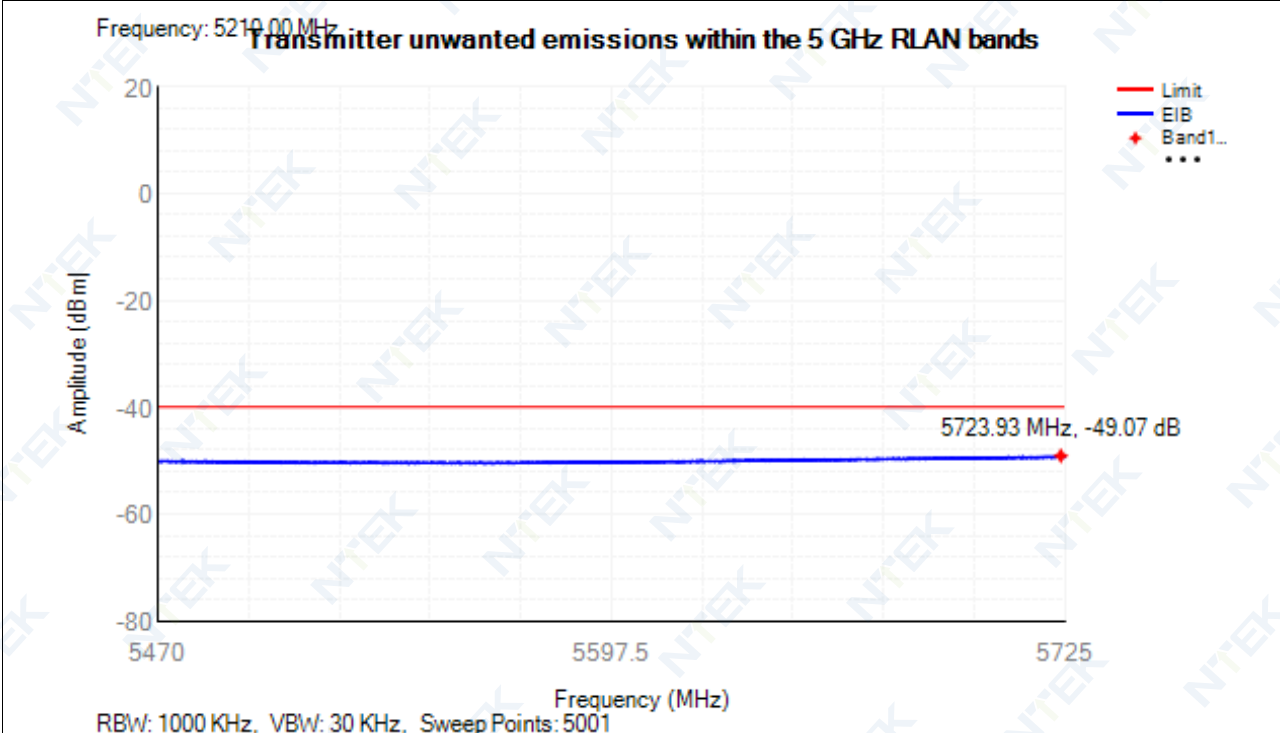

13.6 Receiver spurious emissions

| Condition | Mode | Frequency (MHz) | Antenna | Range (MHz) | Spur Freq (MHz) | Peak (dBm) | RMS (dBm) | Limit (dBm) | Verdict |
|-----------|------|-----------------|---------|-------------|-----------------|------------|-----------|-------------|---------|
| NVNT | a | 5180 | Ant1 | 30 -1000 | 316.7 | -84.11 | NA | -57 | Pass |
| NVNT | a | 5180 | Ant1 | 1000 -26000 | 3477 | -62.41 | NA | -47 | Pass |
| NVNT | n20 | 5180 | Ant1 | 30 -1000 | 616.8 | -84.66 | NA | -57 | Pass |
| NVNT | n20 | 5180 | Ant1 | 1000 -26000 | 16756 | -65.01 | NA | -47 | Pass |
| NVNT | n40 | 5190 | Ant1 | 30 -1000 | 290.2 | -84.38 | NA | -57 | Pass |
| NVNT | n40 | 5190 | Ant1 | 1000 -26000 | 18715 | -64.47 | NA | -47 | Pass |
| NVNT | ac20 | 5180 | Ant1 | 30 -1000 | 926.1 | -83.83 | NA | -57 | Pass |
| NVNT | ac20 | 5180 | Ant1 | 1000 -26000 | 15927 | -62.89 | NA | -47 | Pass |
| NVNT | ac40 | 5190 | Ant1 | 30 -1000 | 926.8 | -84.22 | NA | -57 | Pass |
| NVNT | ac40 | 5190 | Ant1 | 1000 -26000 | 22740 | -64.46 | NA | -47 | Pass |
| NVNT | ac80 | 5210 | Ant1 | 30 -1000 | 288.9 | -83.66 | NA | -57 | Pass |
| NVNT | ac80 | 5210 | Ant1 | 1000 -26000 | 16742 | -63.98 | NA | -47 | Pass |

Test Graphs

Rx. Spurious NVNT a 5180MHz Ant1

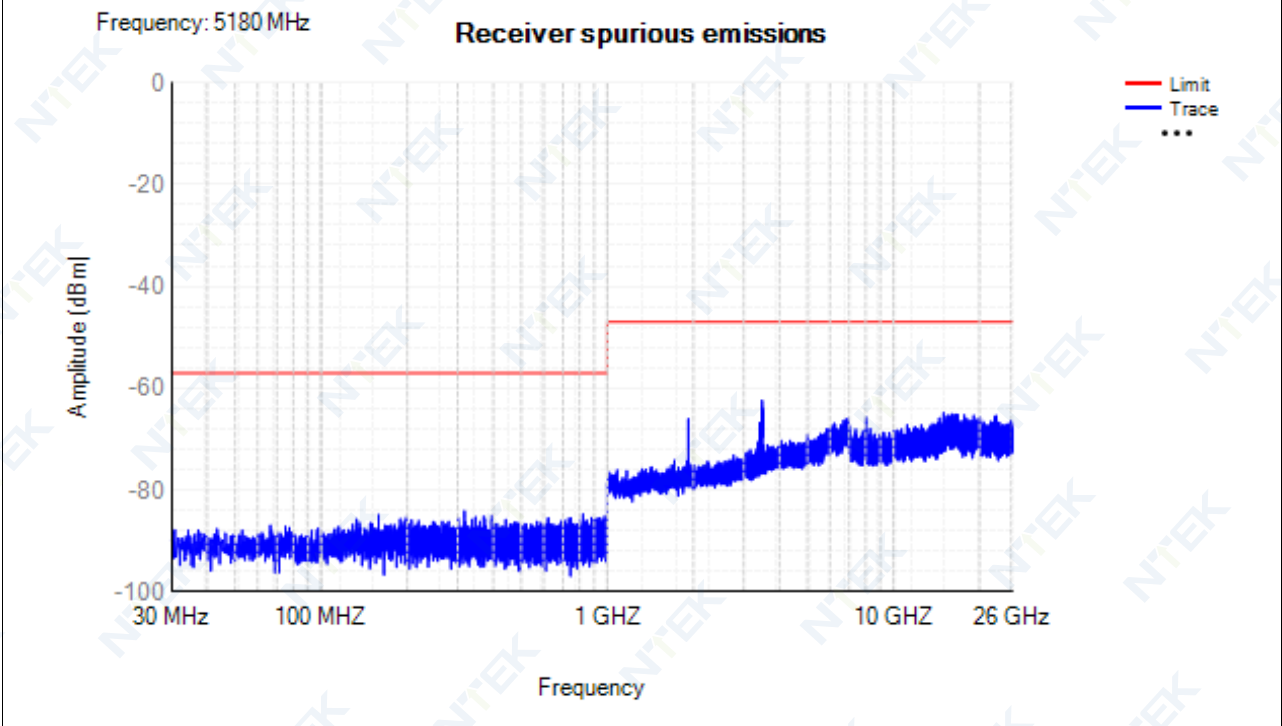

Rx. Spurious NVNT n20 5180MHz Ant1

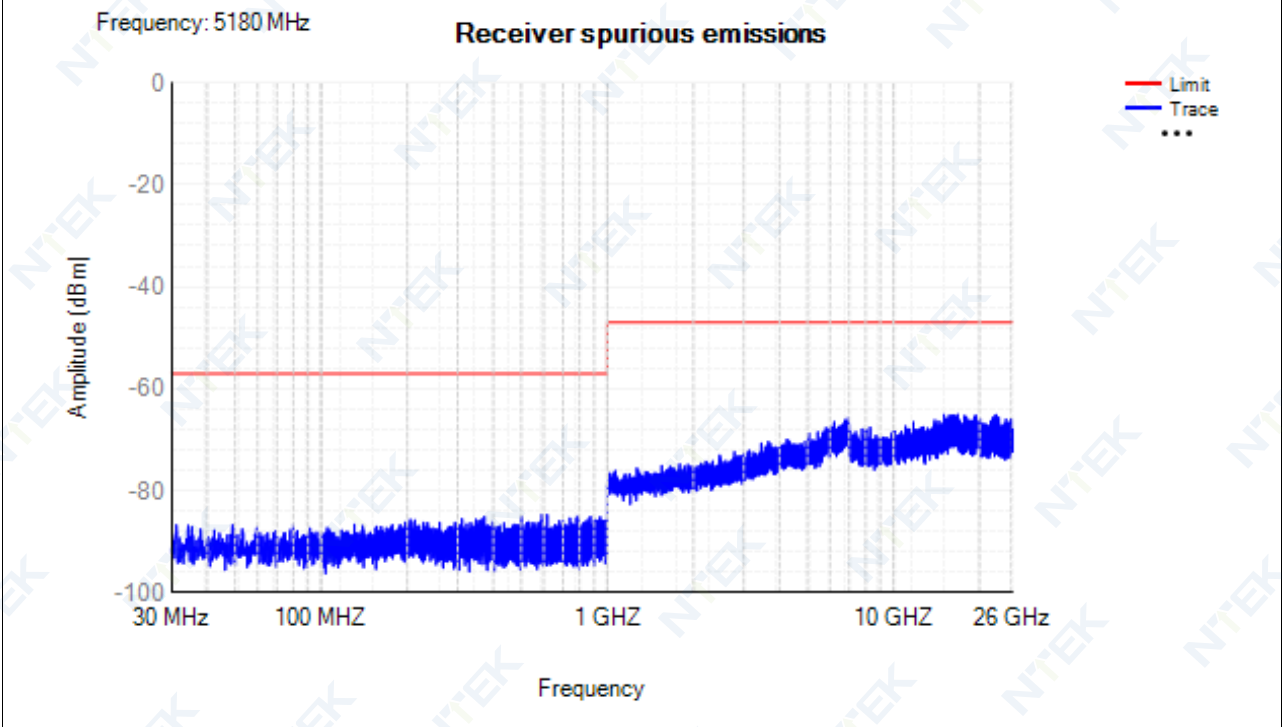

Rx. Spurious NVNT n40 5190MHz Ant1

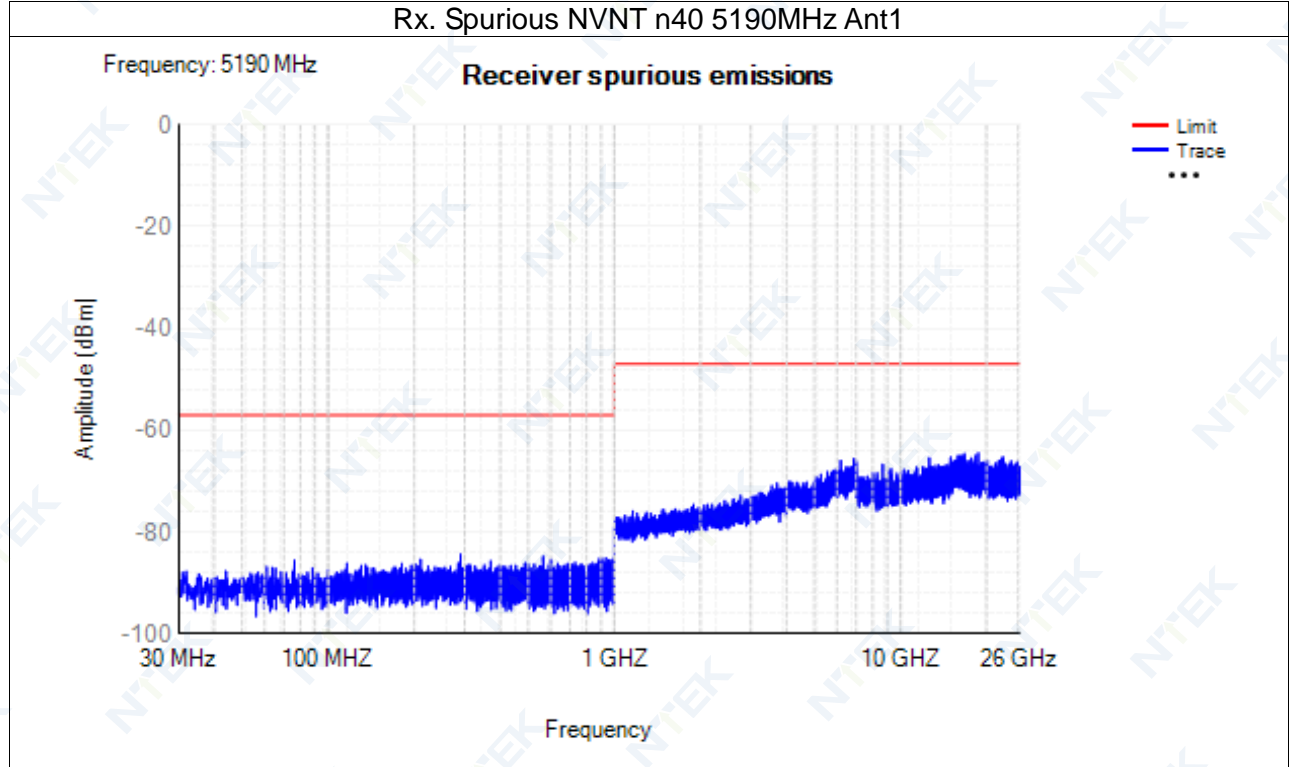

Rx. Spurious NVNT ac20 5180MHz Ant1

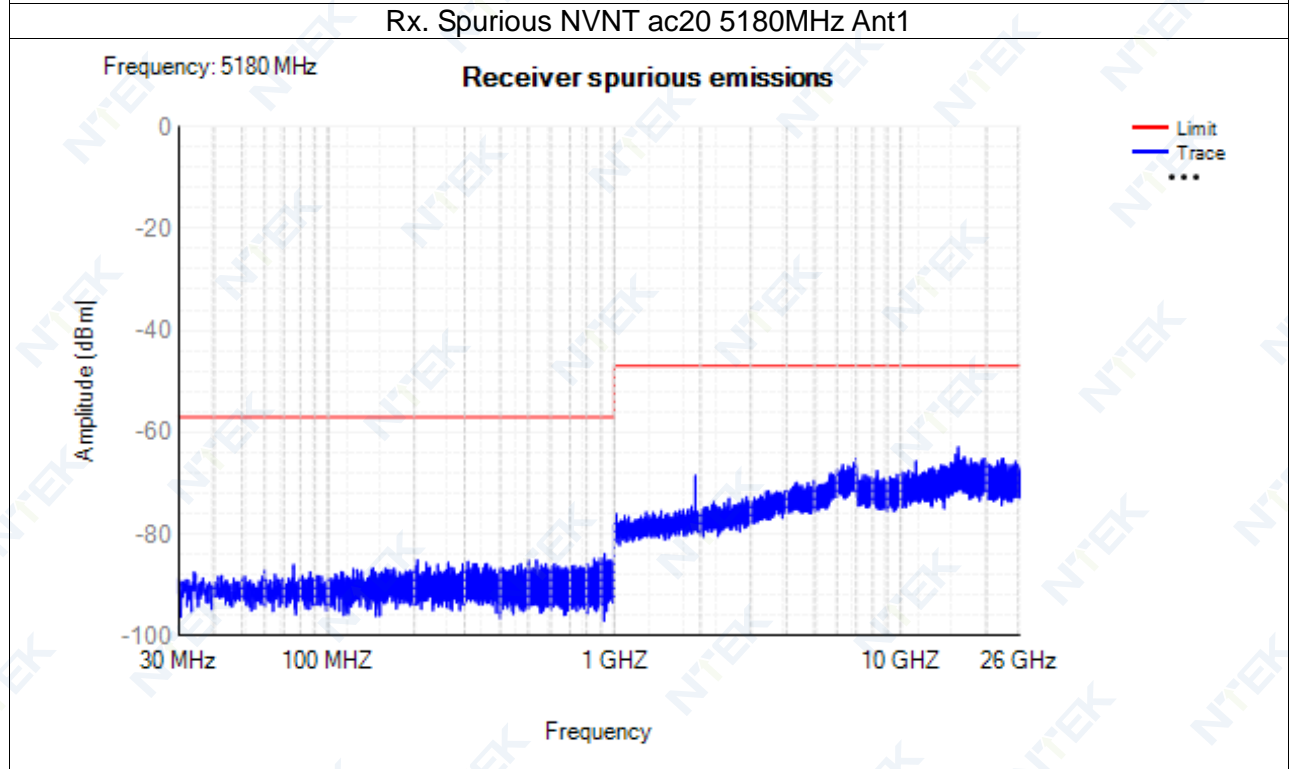

Rx. Spurious NVNT ac40 5190MHz Ant1

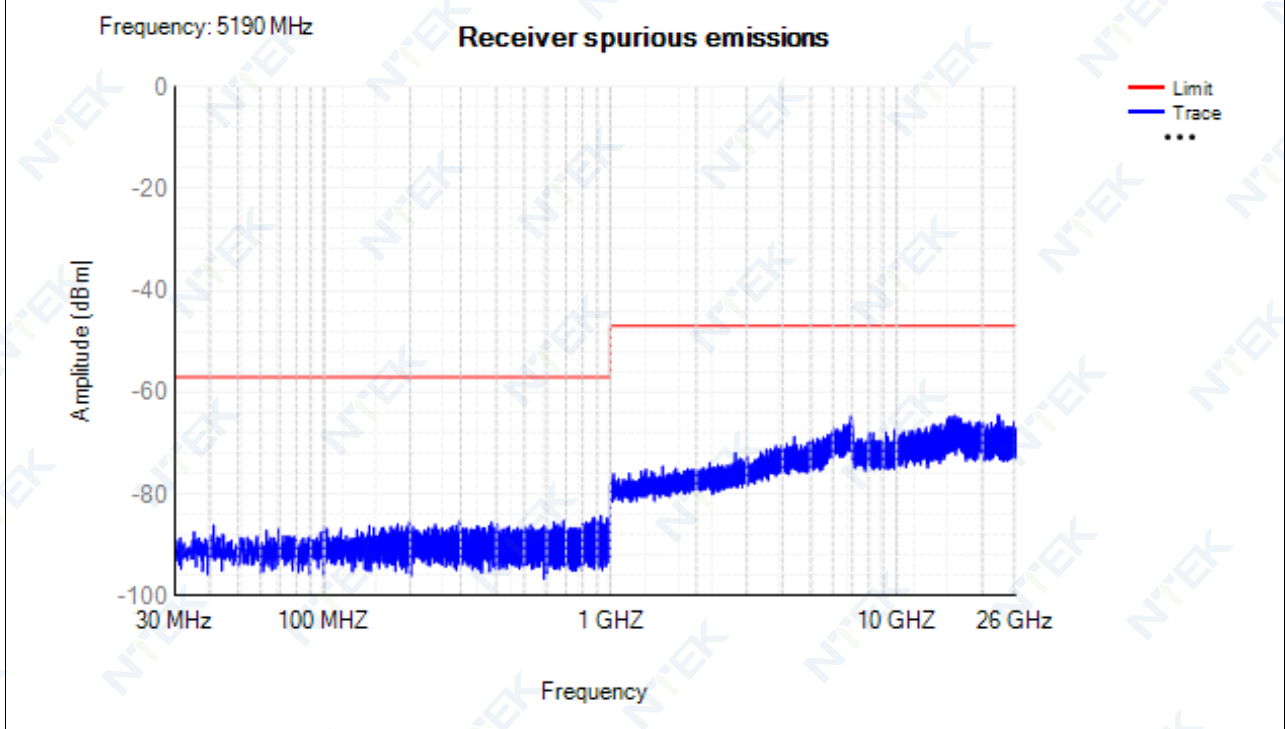

Rx. Spurious NVNT ac80 5210MHz Ant1

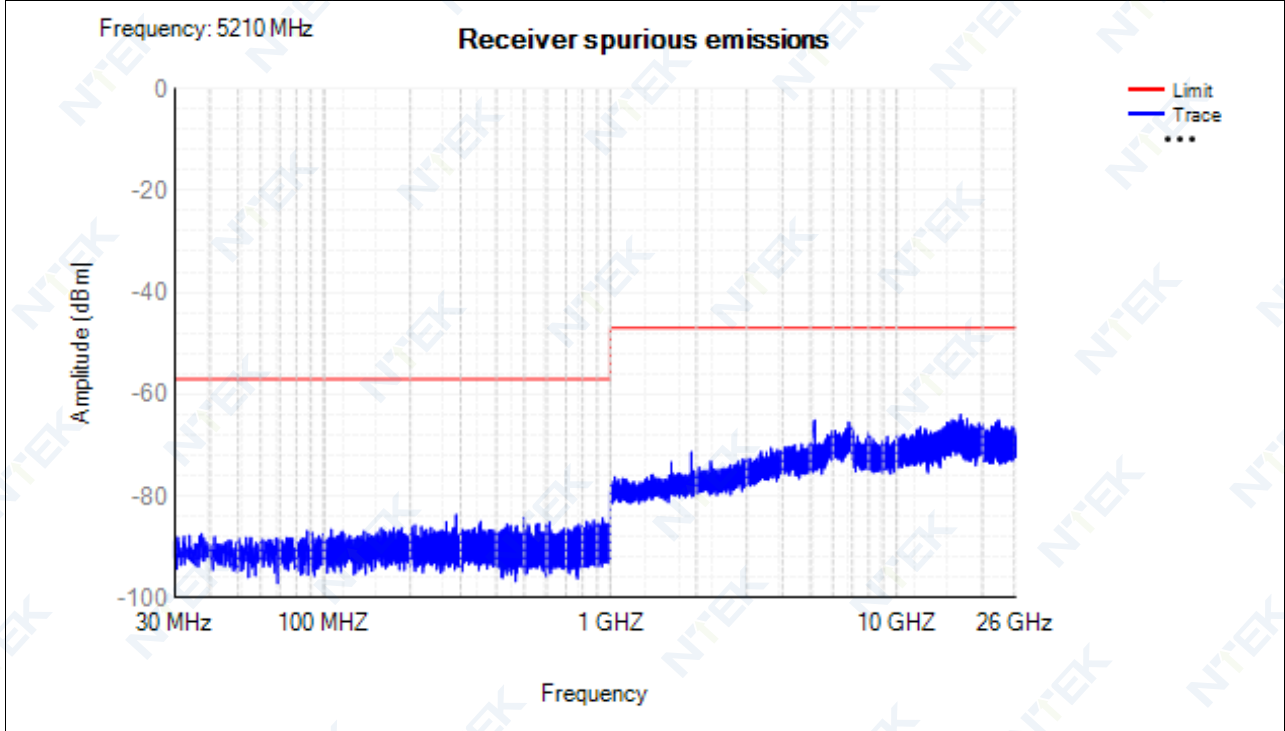

13.7 Adaptivity

| Condition | Mode | Frequency (MHz) | Interfer Type | Interfer Level (dBm/MHz) | Short Control (ms) | Limit (ms) | Short Control (n) | Limit (n) | Verdict |
|-----------|---------------|-----------------|---------------|--------------------------|--------------------|------------|-------------------|-----------|---------|
| NVNT | 802.11a | 5180 | AWGN | -75 | 0 | <=2.5 | 0 | <=50 | Pass |
| NVNT | 802.11a | 5180 | LTE | -75 | 0 | <=2.5 | 0 | <=50 | Pass |
| NVNT | 802.11a | 5180 | OFDM | -75 | 0 | <=2.5 | 0 | <=50 | Pass |
| NVNT | 802.11ac80 | 5210 | AWGN | -75 | 0 | <=2.5 | 0 | <=50 | Pass |
| NVNT | 802.11ac80 | 5210 | LTE | -75 | 0 | <=2.5 | 0 | <=50 | Pass |
| NVNT | 802.11ac80 | 5210 | OFDM | -75 | 0 | <=2.5 | 0 | <=50 | Pass |
| NVNT | 802.11n(HT40) | 5190 | AWGN | -65 | 0 | <=2.5 | 0 | <=50 | Pass |
| NVNT | 802.11n(HT40) | 5190 | LTE | -65 | 0 | <=2.5 | 0 | <=50 | Pass |
| NVNT | 802.11n(HT40) | 5190 | OFDM | -65 | 0 | <=2.5 | 0 | <=50 | Pass |

Adaptivity NVNT 802.11a 5180MHz AWGN

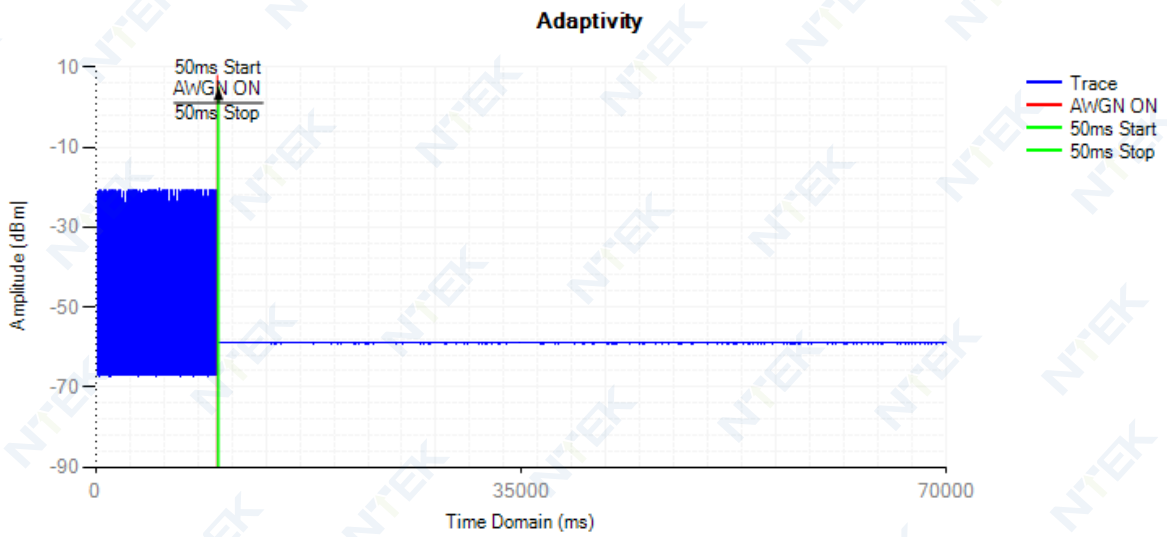

Control Signal NVNT 802.11a 5180MHz AWGN

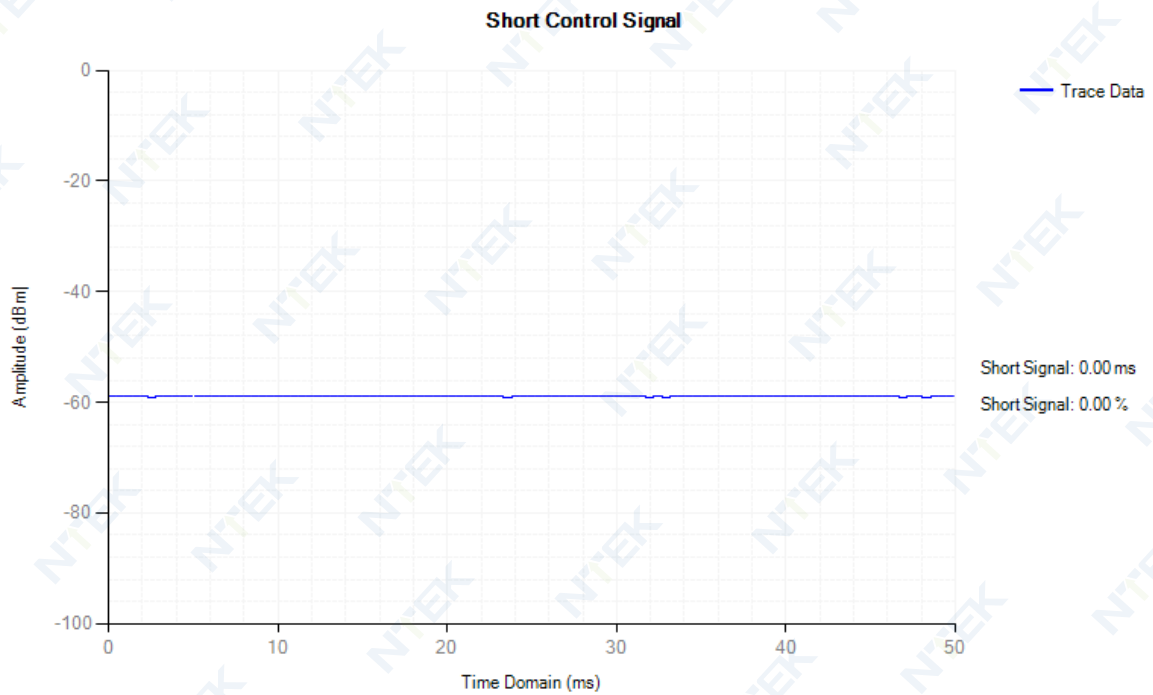

Adaptivity NVNT 802.11a 5180MHz LTE

Adaptivity

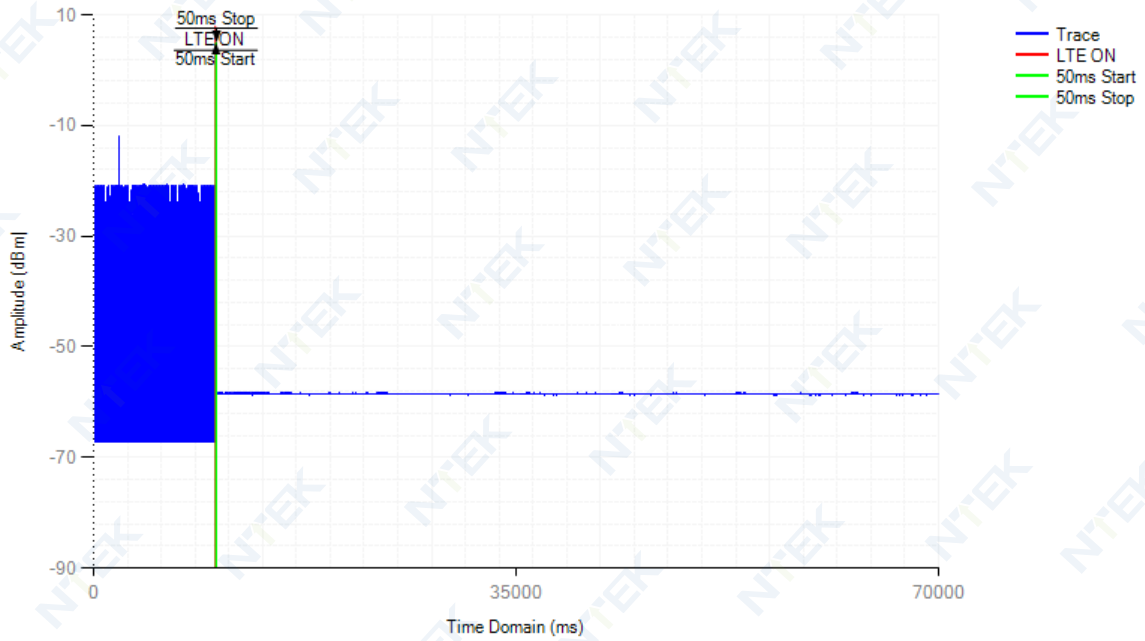

Control Signal NVNT 802.11a 5180MHz LTE

Short Control Signal

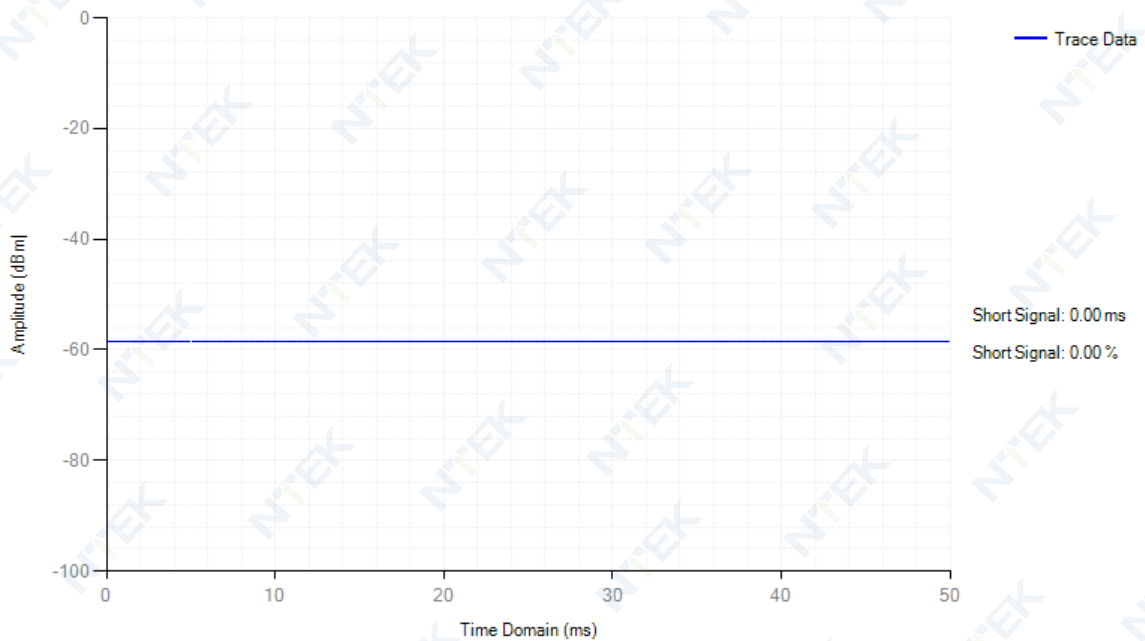

Adaptivity NVNT 802.11a 5180MHz OFDM

Adaptivity

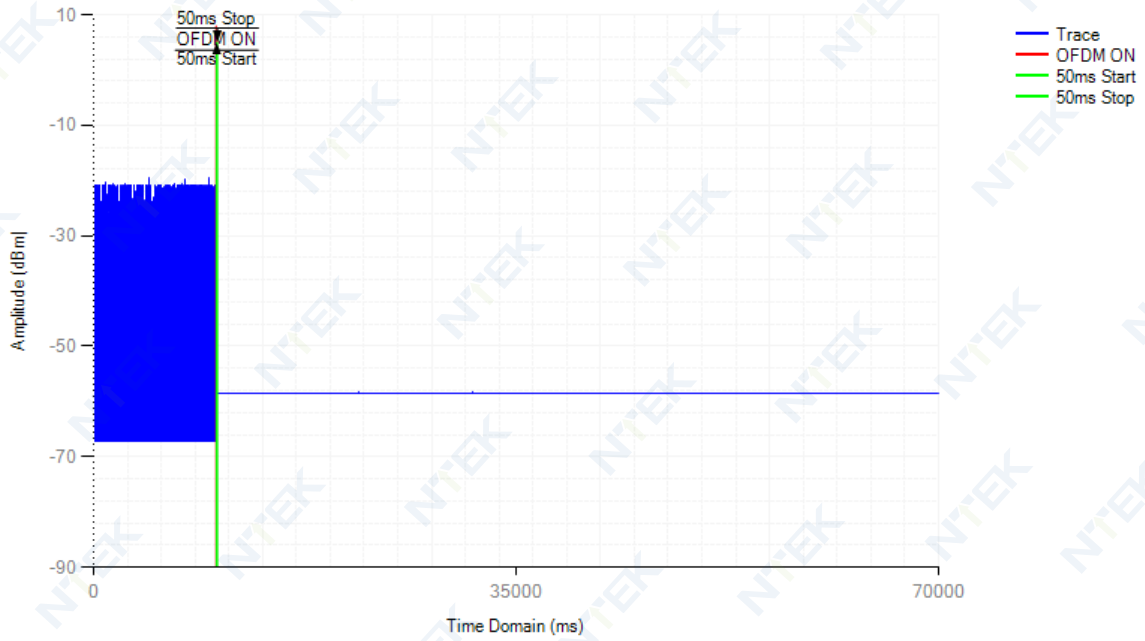

Control Signal NVNT 802.11a 5180MHz OFDM

Short Control Signal

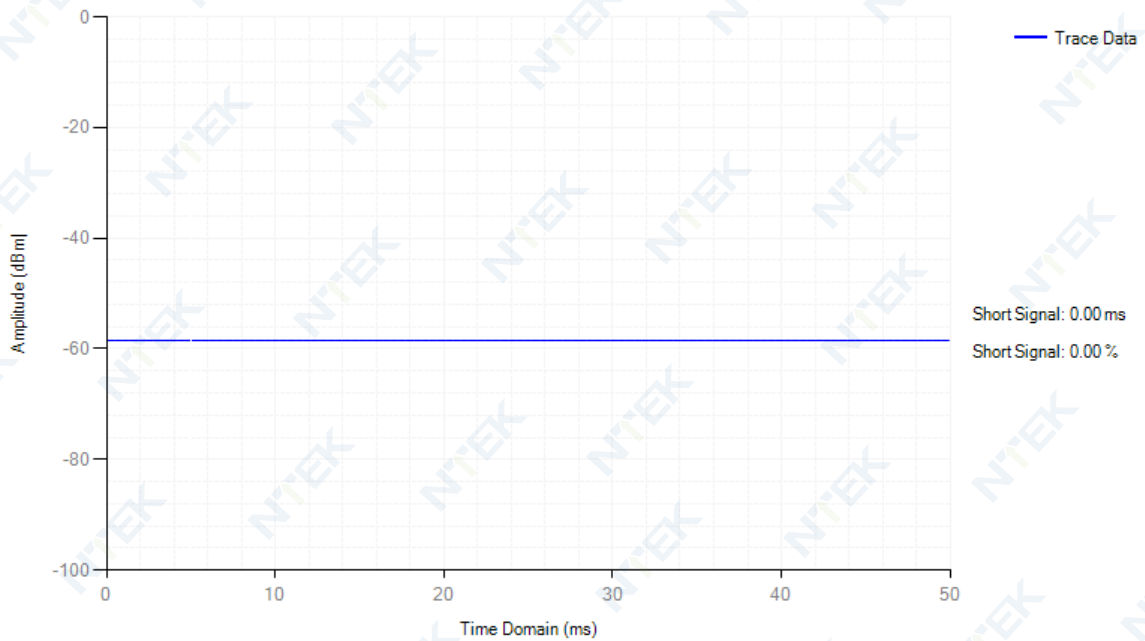

Adaptivity NVNT 802.11ac80 5210MHz AWGN

Adaptivity

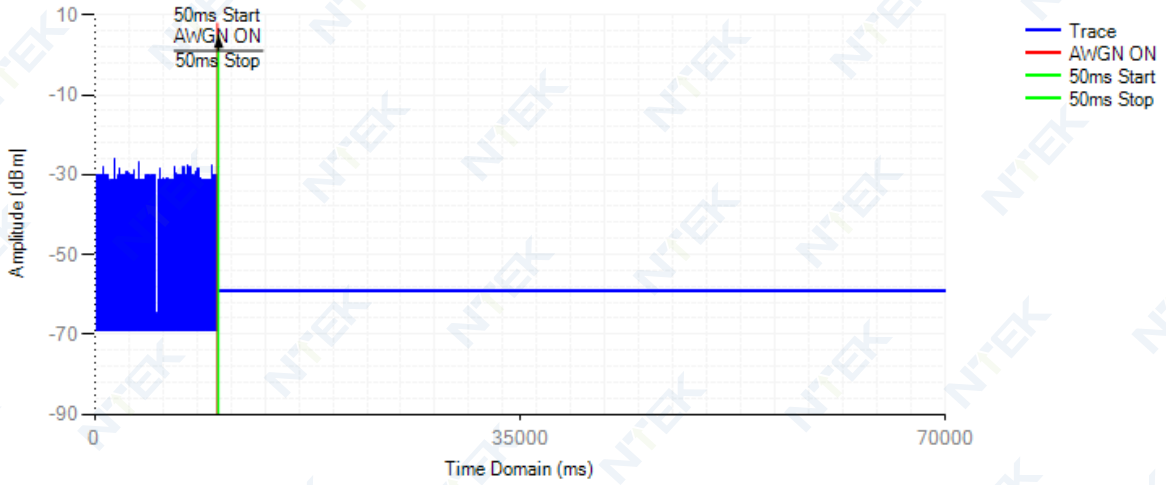

Control Signal NVNT 802.11ac80 5210MHz AWGN

Short Control Signal

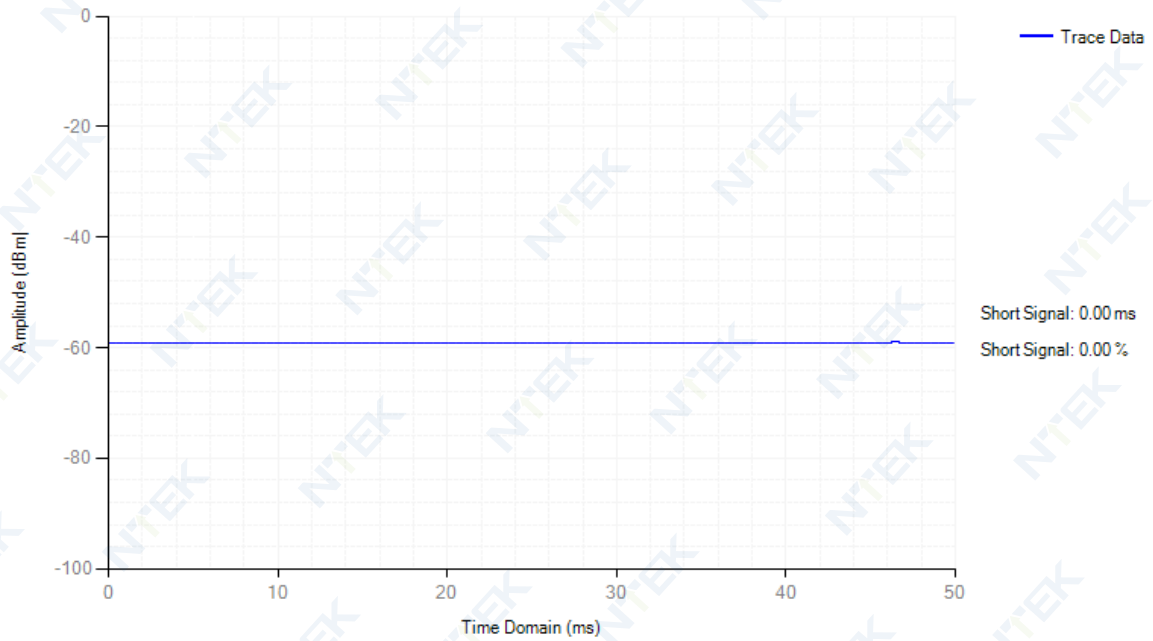

Adaptivity NVNT 802.11ac80 5210MHz LTE

Adaptivity

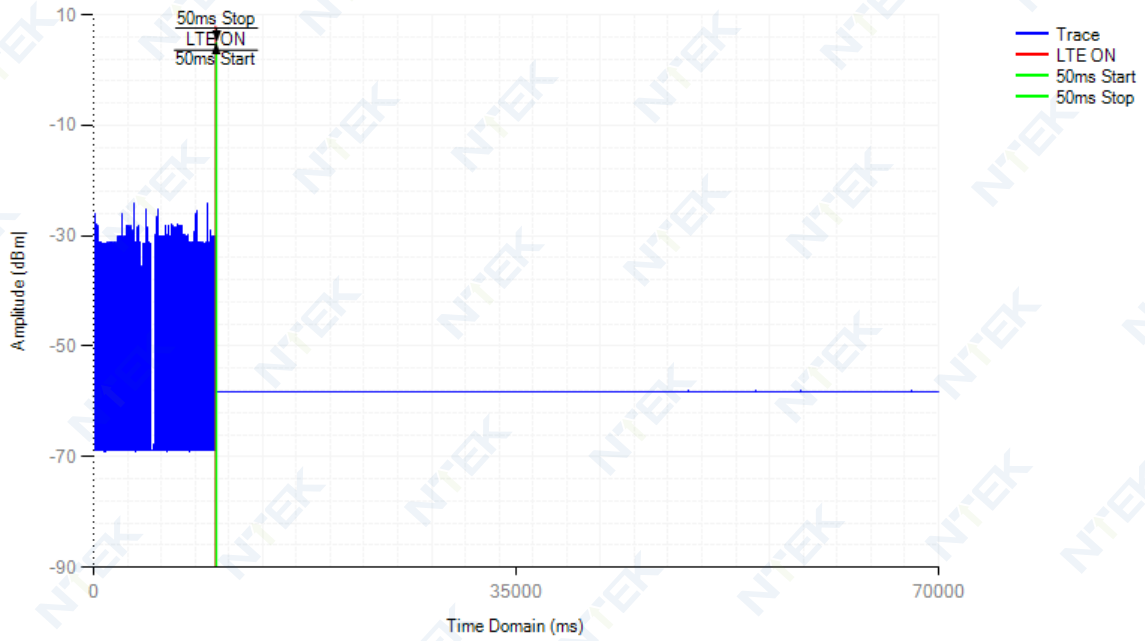

Control Signal NVNT 802.11ac80 5210MHz LTE

Short Control Signal

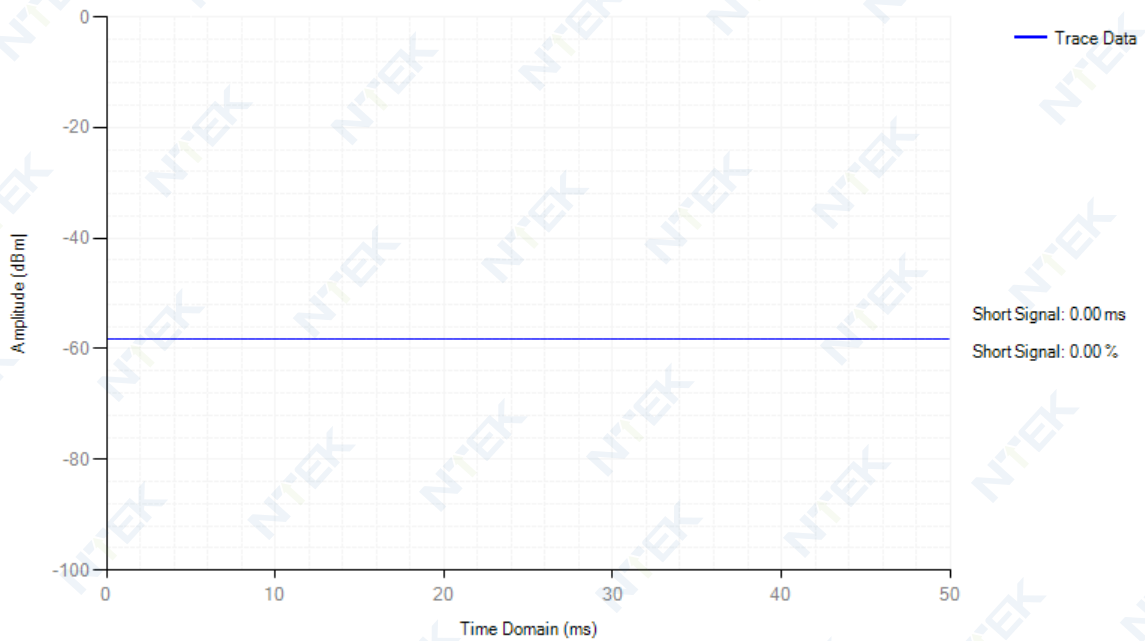

Adaptivity NVNT 802.11ac80 5210MHz OFDM

Adaptivity

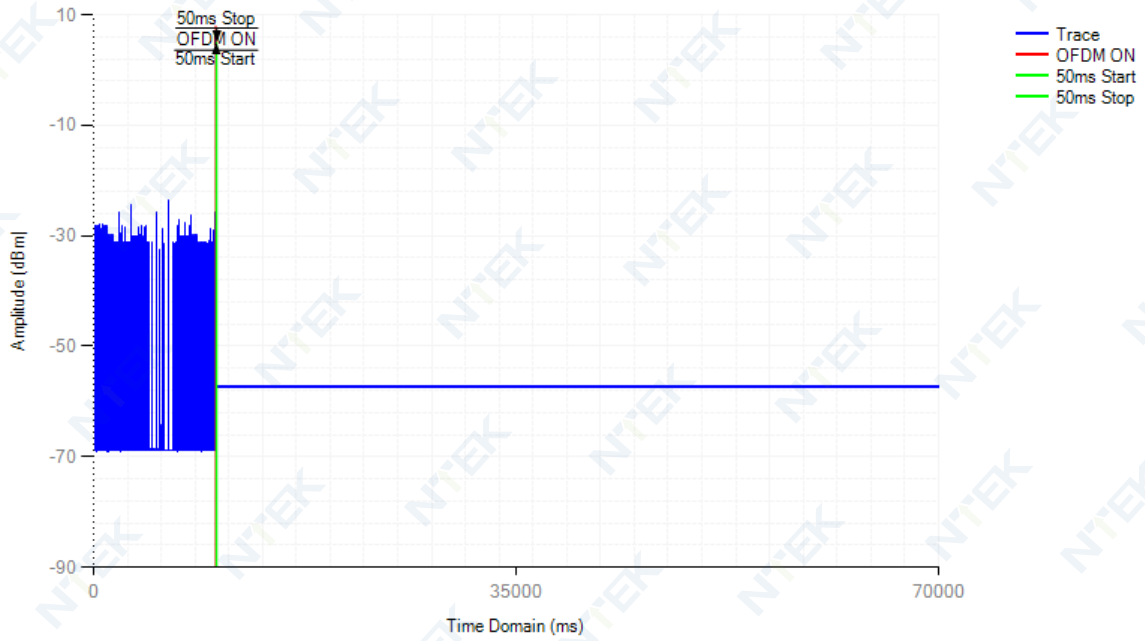

Control Signal NVNT 802.11ac80 5210MHz OFDM

Short Control Signal

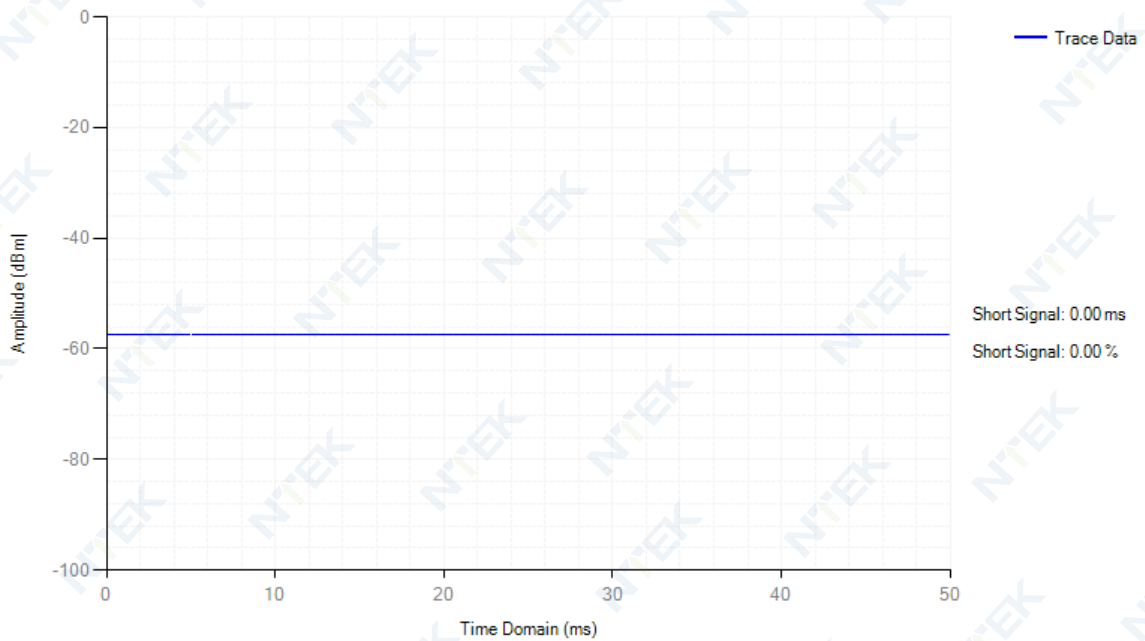

Adaptivity NVNT 802.11n(HT40) 5190MHz AWGN

Adaptivity

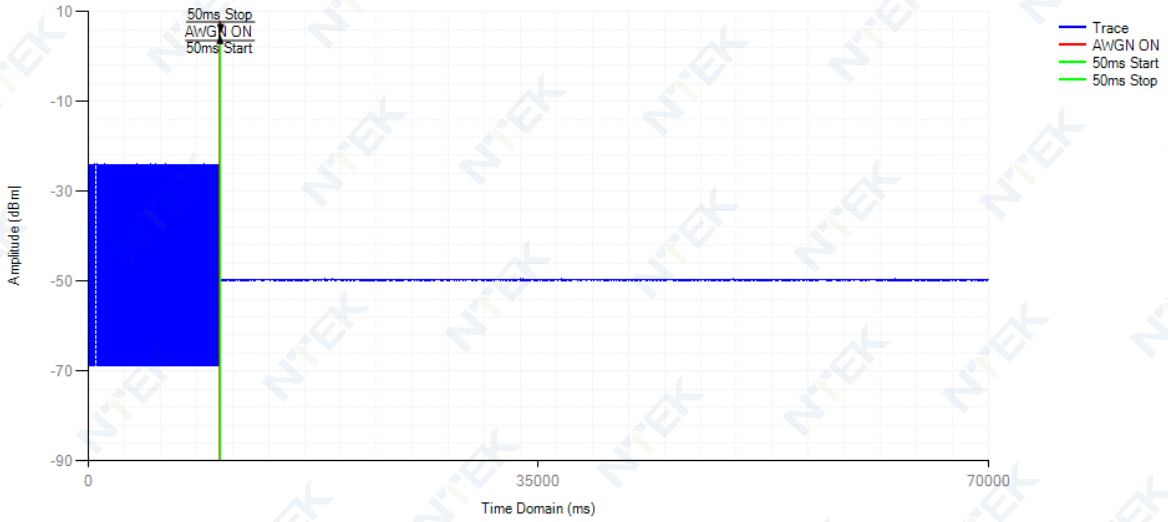

Control Signal NVNT 802.11n(HT40) 5190MHz AWGN

Short Control Signal

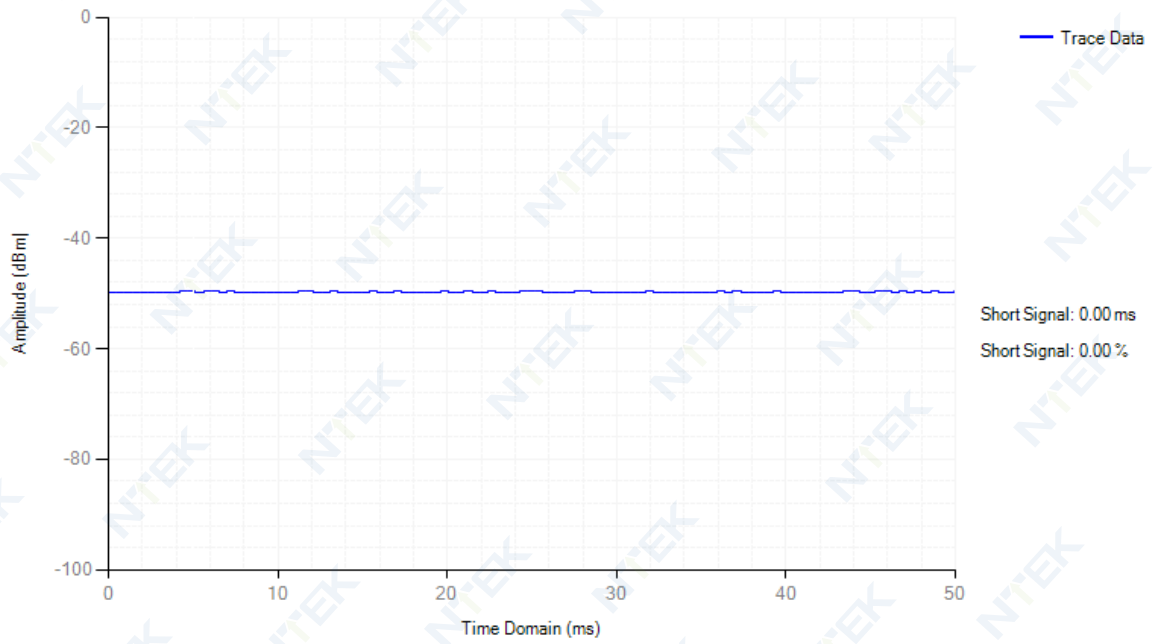

Adaptivity NVNT 802.11n(HT40) 5190MHz LTE

Adaptivity

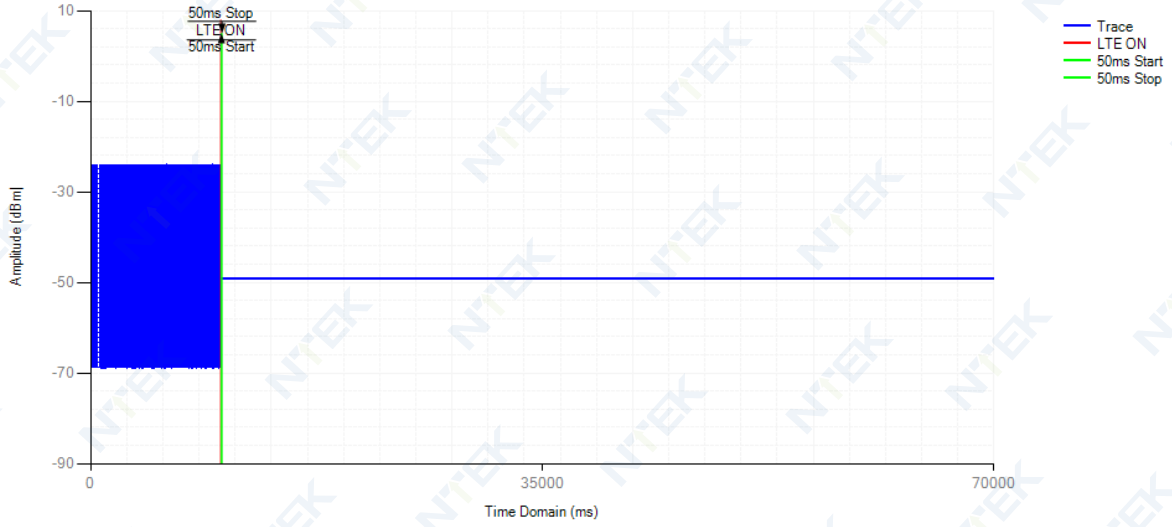

Control Signal NVNT 802.11n(HT40) 5190MHz LTE

Short Control Signal

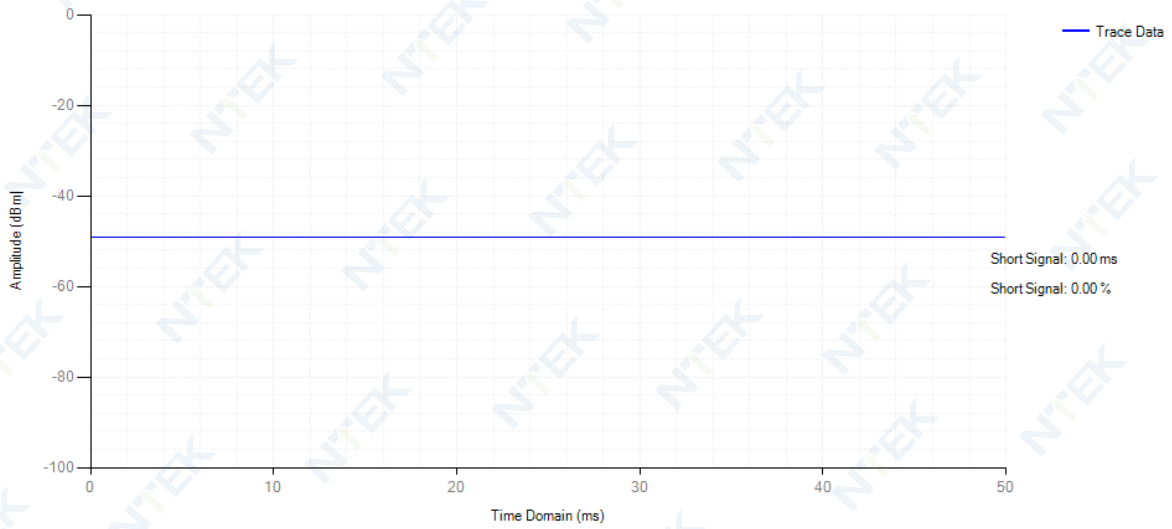

Adaptivity NVNT 802.11n(HT40) 5190MHz OFDM

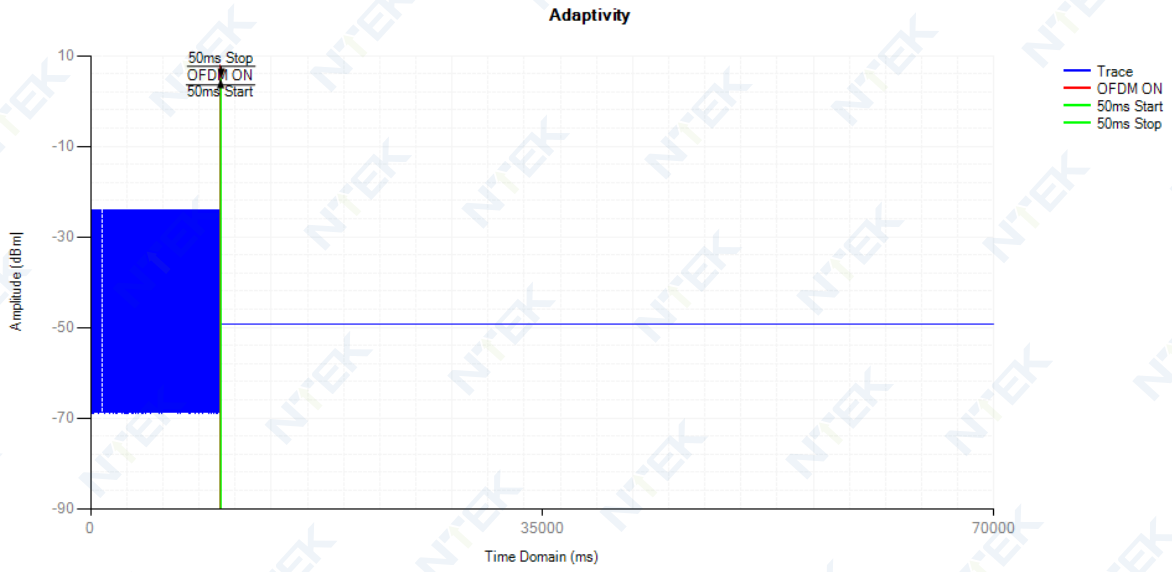

Control Signal NVNT 802.11n(HT40) 5190MHz OFDM

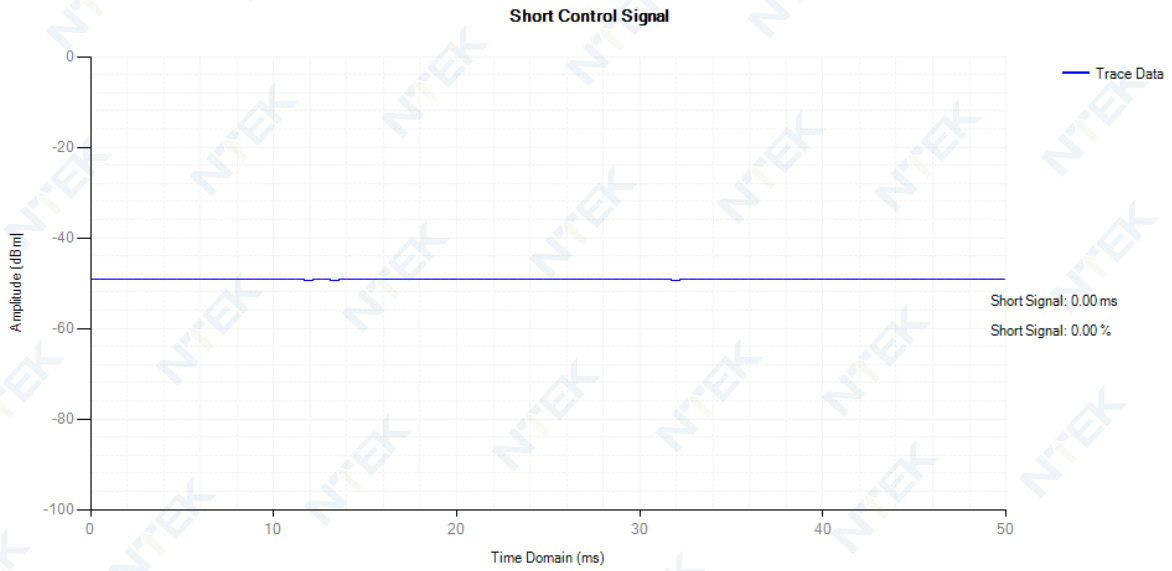

13.8 Adaptivity COT Channel Occupancy Time

| Condition | Mode | Frequency (MHz) | Priority Class | Max COT (ms) | Limit COT (ms) | Min Idle Time (ms) | Limit Idle Time (ms) | Verdict |
|-----------|---------------|-----------------|----------------|--------------|----------------|--------------------|----------------------|---------|
| NVNT | 802.11a | 5180 | 1 | 0.838 | <=6 | 0.035 | >0.027 | Pass |
| NVNT | 802.11ac80 | 5210 | 2 | 0.41 | <=6 | 0.035 | >0.027 | Pass |
| NVNT | 802.11n(HT40) | 5190 | 1 | 3.493 | <=6 | 0.095 | >0.027 | Pass |

COT NVNT 802.11a 5180MHz

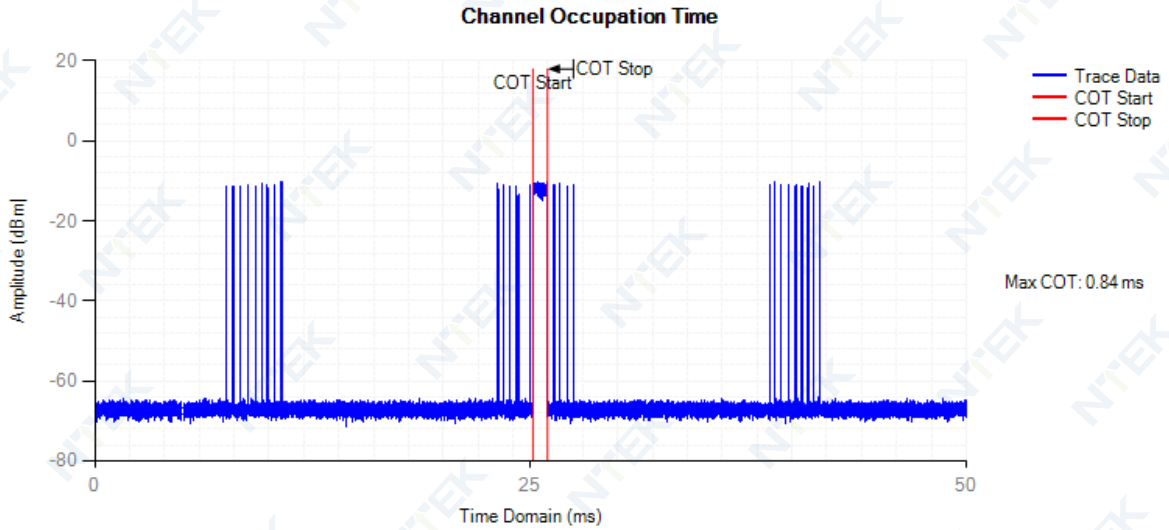

Idle NVNT 802.11a 5180MHz

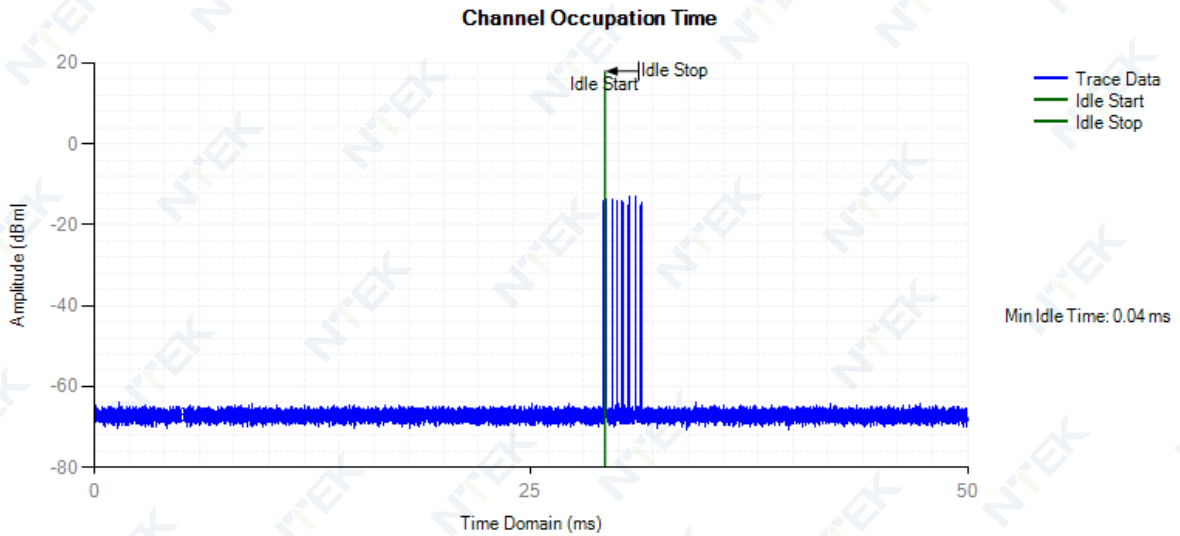

COT NVNT 802.11ac80 5210MHz

Channel Occupation Time

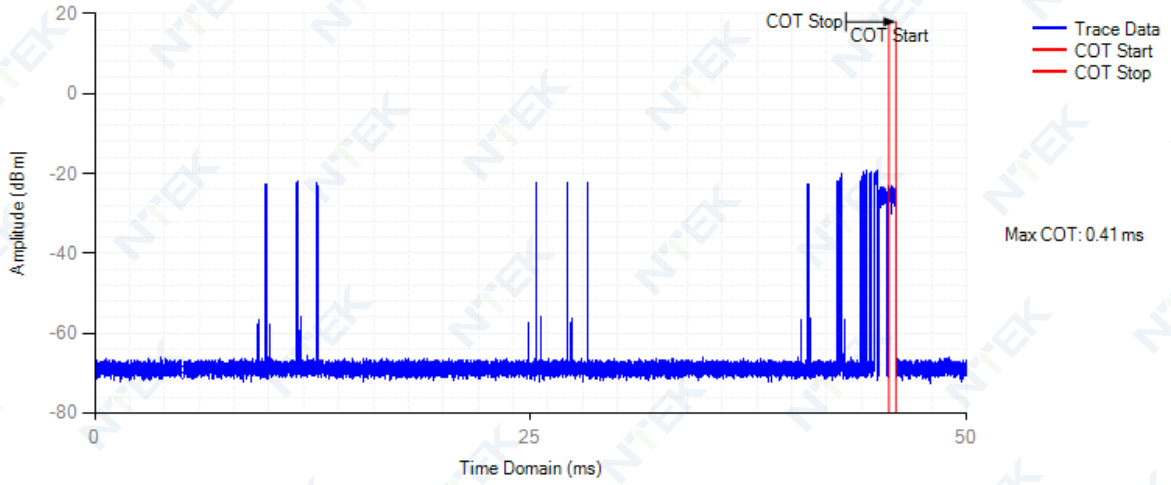

Idle NVNT 802.11ac80 5210MHz

Channel Occupation Time

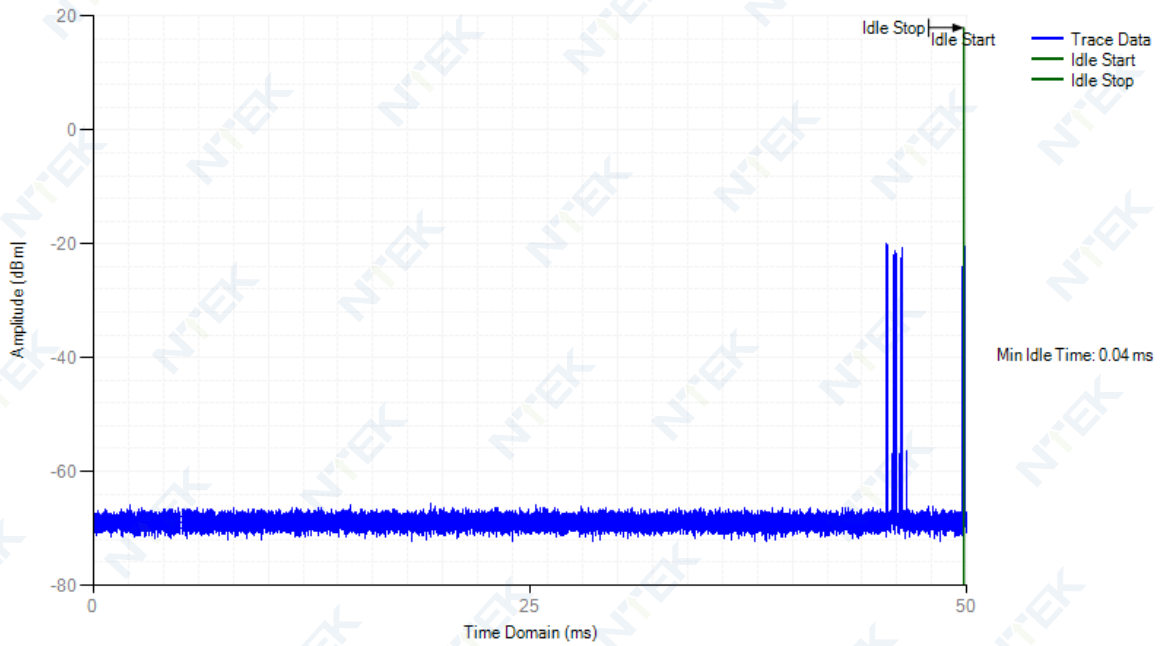

COT NVNT 802.11n(HT40) 5190MHz

Channel Occupation Time

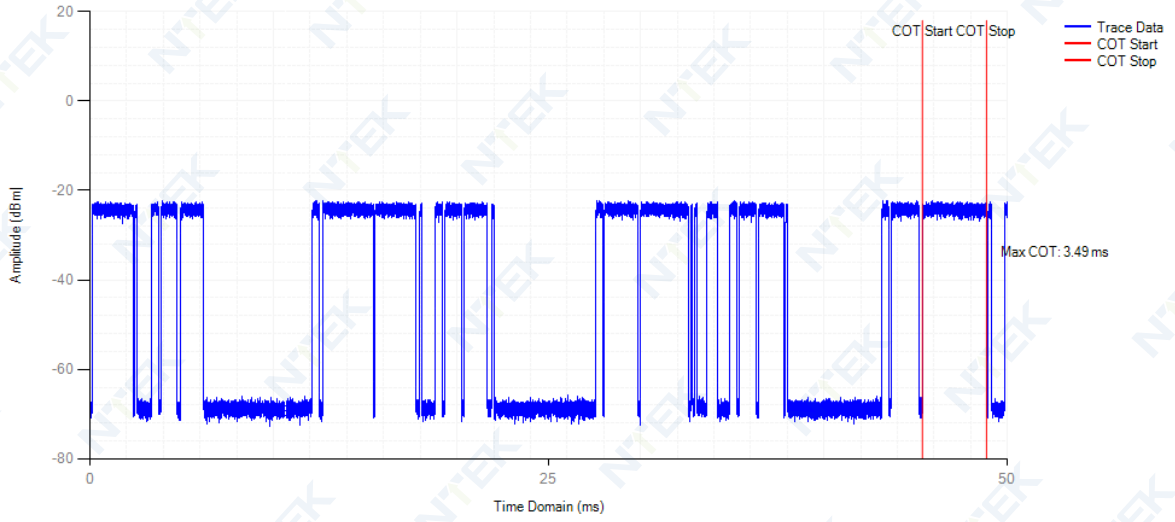

Idle NVNT 802.11n(HT40) 5190MHz

Channel Occupation Time

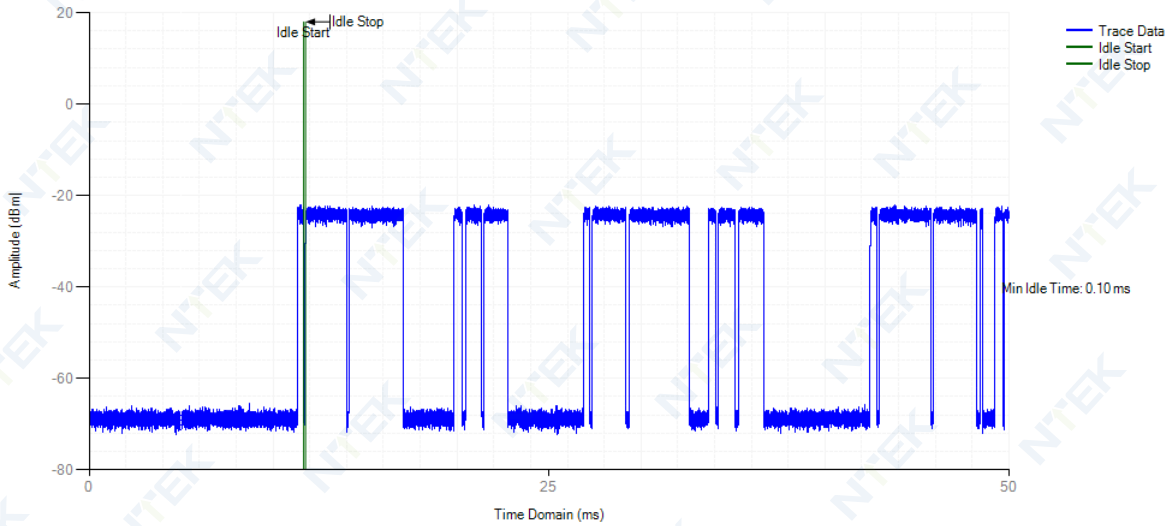

13.9 Adaptivity COT Idle Period Probability

| Condition | Mode | Frequency (MHz) | Priority Class | Bn | H(Bn) | Pn (%) | Limit (%) | Verdict |
|-----------|---------------|-----------------|----------------|----|-------|--------|-----------|---------|
| NVNT | 802.11a | 5180 | 1 | 0 | 377 | 3.77 | 5 | Pass |
| NVNT | 802.11a | 5180 | 1 | 1 | 0 | 3.77 | 12 | Pass |
| NVNT | 802.11a | 5180 | 1 | 2 | 0 | 3.77 | 18.25 | Pass |
| NVNT | 802.11a | 5180 | 1 | 3 | 3 | 3.8 | 24.5 | Pass |
| NVNT | 802.11a | 5180 | 1 | 4 | 3 | 3.83 | 30.75 | Pass |
| NVNT | 802.11a | 5180 | 1 | 5 | 1 | 3.84 | 37 | Pass |
| NVNT | 802.11a | 5180 | 1 | 6 | 2 | 3.86 | 43.25 | Pass |
| NVNT | 802.11a | 5180 | 1 | 7 | 1 | 3.87 | 49.5 | Pass |
| NVNT | 802.11a | 5180 | 1 | 8 | 0 | 3.87 | 55.75 | Pass |
| NVNT | 802.11a | 5180 | 1 | 9 | 1 | 3.88 | 62 | Pass |
| NVNT | 802.11a | 5180 | 1 | 10 | 1 | 3.89 | 68.25 | Pass |
| NVNT | 802.11a | 5180 | 1 | 11 | 2 | 3.91 | 74.5 | Pass |
| NVNT | 802.11a | 5180 | 1 | 12 | 1 | 3.92 | 80.75 | Pass |
| NVNT | 802.11a | 5180 | 1 | 13 | 0 | 3.92 | 87 | Pass |
| NVNT | 802.11a | 5180 | 1 | 14 | 2 | 3.94 | 93.25 | Pass |
| NVNT | 802.11a | 5180 | 1 | 15 | 0 | 3.94 | 99.5 | Pass |
| NVNT | 802.11a | 5180 | 1 | 16 | 9616 | 100 | 100 | Pass |
| NVNT | 802.11ac80 | 5210 | 2 | 0 | 1103 | 3.11 | 5 | Pass |
| NVNT | 802.11ac80 | 5210 | 2 | 1 | 23 | 11.26 | 12 | Pass |
| NVNT | 802.11ac80 | 5210 | 2 | 2 | 12 | 11.38 | 18.25 | Pass |
| NVNT | 802.11ac80 | 5210 | 2 | 3 | 13 | 11.51 | 24.5 | Pass |
| NVNT | 802.11ac80 | 5210 | 2 | 4 | 5 | 11.56 | 30.75 | Pass |
| NVNT | 802.11ac80 | 5210 | 2 | 5 | 6 | 11.62 | 37 | Pass |
| NVNT | 802.11ac80 | 5210 | 2 | 6 | 36 | 11.98 | 43.25 | Pass |
| NVNT | 802.11ac80 | 5210 | 2 | 7 | 34 | 12.32 | 49.5 | Pass |
| NVNT | 802.11ac80 | 5210 | 2 | 8 | 40 | 12.72 | 55.75 | Pass |
| NVNT | 802.11ac80 | 5210 | 2 | 9 | 29 | 13.01 | 62 | Pass |
| NVNT | 802.11ac80 | 5210 | 2 | 10 | 27 | 13.28 | 68.25 | Pass |
| NVNT | 802.11ac80 | 5210 | 2 | 11 | 32 | 13.6 | 74.5 | Pass |
| NVNT | 802.11ac80 | 5210 | 2 | 12 | 20 | 13.8 | 80.75 | Pass |
| NVNT | 802.11ac80 | 5210 | 2 | 13 | 23 | 14.03 | 87 | Pass |
| NVNT | 802.11ac80 | 5210 | 2 | 14 | 1 | 14.04 | 93.25 | Pass |
| NVNT | 802.11ac80 | 5210 | 2 | 15 | 1 | 14.05 | 99.5 | Pass |
| NVNT | 802.11ac80 | 5210 | 2 | 16 | 8596 | 100 | 100 | Pass |
| NVNT | 802.11n(HT40) | 5190 | 1 | 0 | 5 | 4.24 | 5 | Pass |
| NVNT | 802.11n(HT40) | 5190 | 1 | 1 | 0 | 4.24 | 12 | Pass |
| NVNT | 802.11n(HT40) | 5190 | 1 | 2 | 0 | 4.24 | 18.25 | Pass |
| NVNT | 802.11n(HT40) | 5190 | 1 | 3 | 16 | 17.8 | 24.5 | Pass |
| NVNT | 802.11n(HT40) | 5190 | 1 | 4 | 3 | 20.34 | 30.75 | Pass |
| NVNT | 802.11n(HT40) | 5190 | 1 | 5 | 7 | 26.27 | 37 | Pass |
| NVNT | 802.11n(HT40) | 5190 | 1 | 6 | 3 | 28.81 | 43.25 | Pass |
| NVNT | 802.11n(HT40) | 5190 | 1 | 7 | 3 | 31.36 | 49.5 | Pass |
| NVNT | 802.11n(HT40) | 5190 | 1 | 8 | 9 | 38.98 | 55.75 | Pass |
| NVNT | 802.11n(HT40) | 5190 | 1 | 9 | 7 | 44.92 | 62 | Pass |
| NVNT | 802.11n(HT40) | 5190 | 1 | 10 | 4 | 48.31 | 68.25 | Pass |
| NVNT | 802.11n(HT40) | 5190 | 1 | 11 | 7 | 54.24 | 74.5 | Pass |
| NVNT | 802.11n(HT40) | 5190 | 1 | 12 | 6 | 59.32 | 80.75 | Pass |
| NVNT | 802.11n(HT40) | 5190 | 1 | 13 | 1 | 60.17 | 87 | Pass |
| NVNT | 802.11n(HT40) | 5190 | 1 | 14 | 5 | 64.41 | 93.25 | Pass |
| NVNT | 802.11n(HT40) | 5190 | 1 | 15 | 3 | 66.95 | 99.5 | Pass |
| NVNT | 802.11n(HT40) | 5190 | 1 | 16 | 39 | 100 | 100 | Pass |

Idle Period Probability NVNT 802.11a 5180MHz

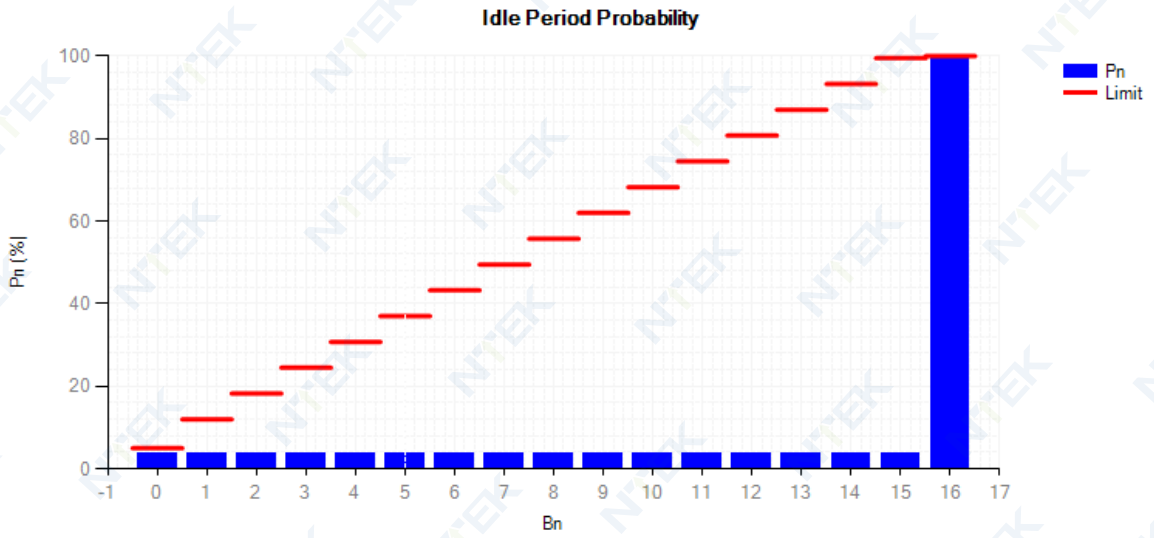

Idle Period Probability NVNT 802.11ac80 5210MHz

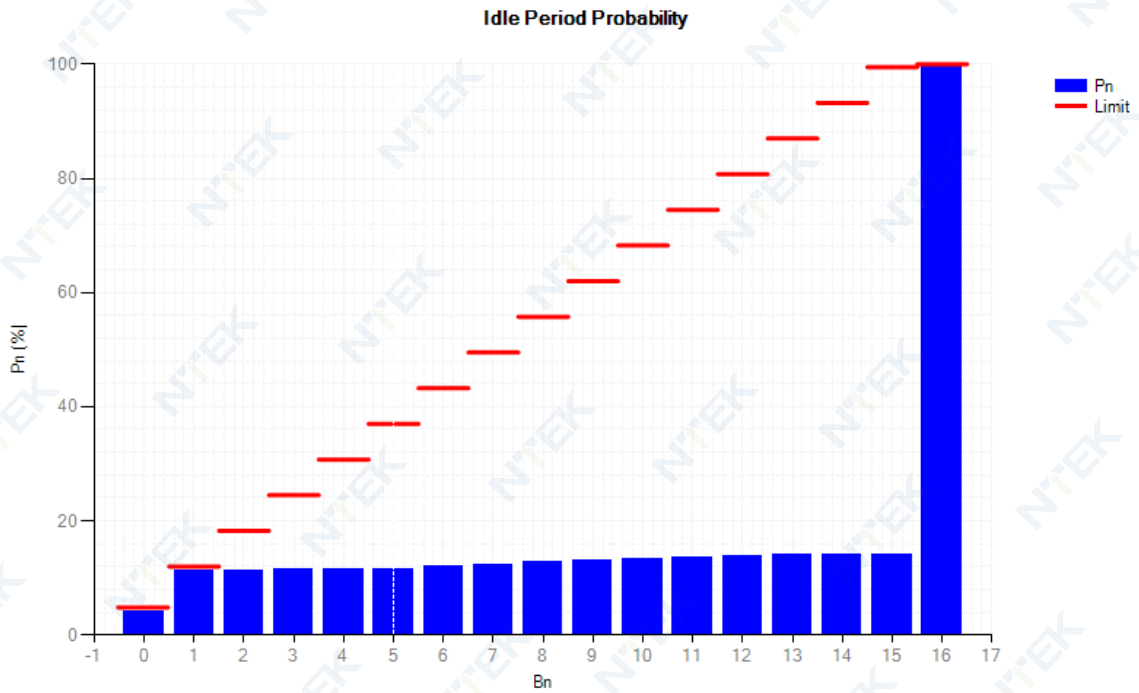

Idle Period Probability NVNT 802.11n(HT40) 5190MHz

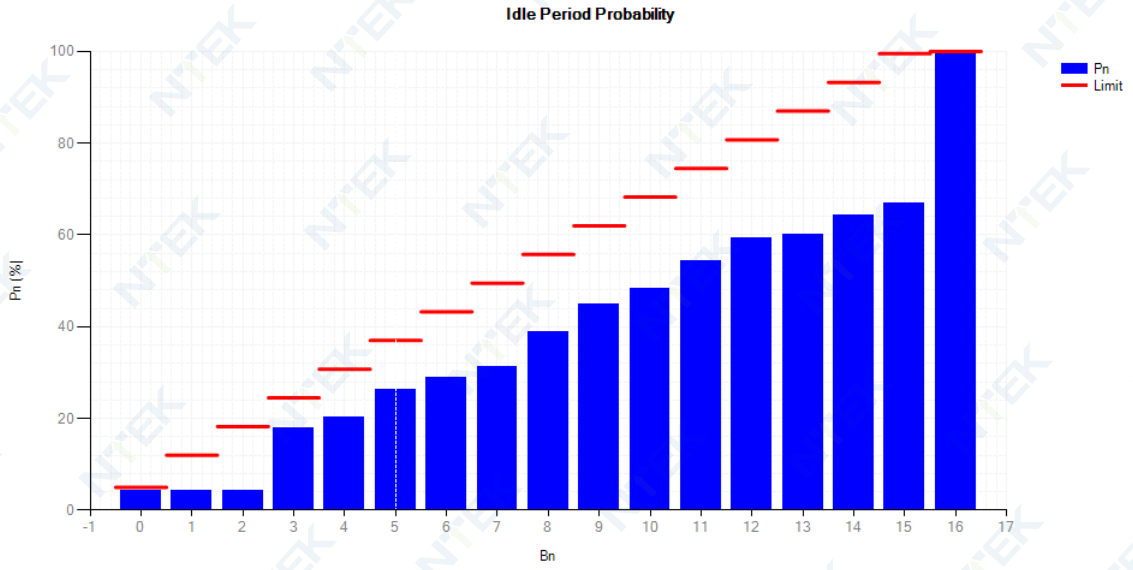

14. EUT TEST PHOTO

SPURIOUS EMISSIONS MEASUREMENT PHOTOS

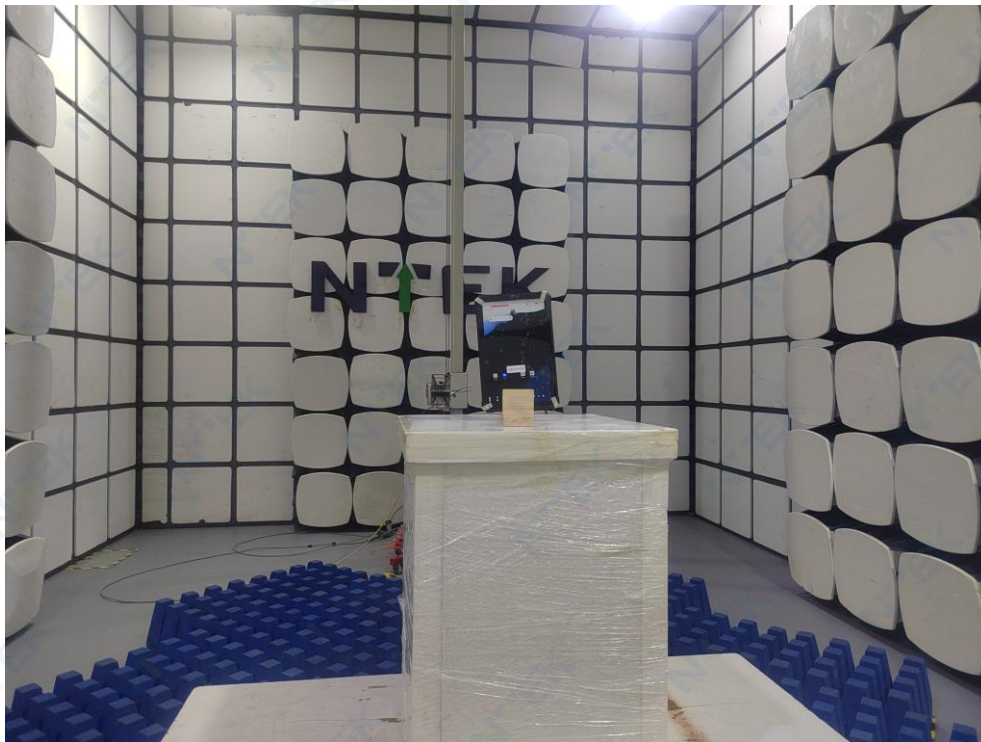
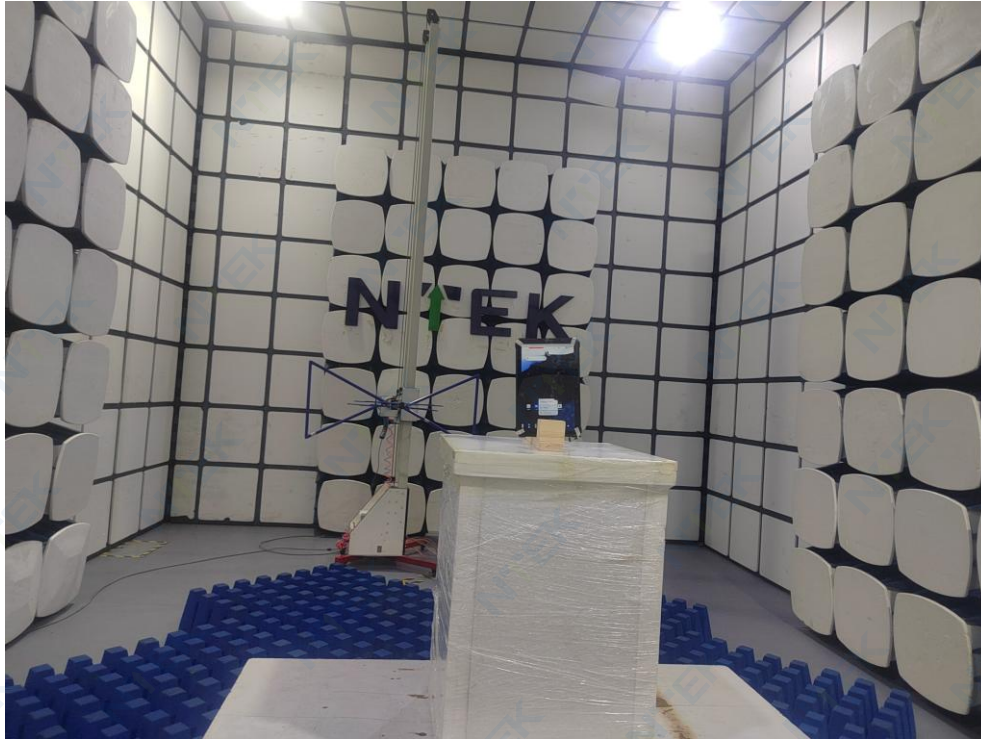

END OF REPORT