

# Radio Test Report-2.4G BT

## ETSI EN 300 328 V2.2.2 (2019-07)

### Client Information:

Applicant: DOKE COMMUNICATION (HK) LIMITED

Applicant add.: RM 1902 EASEY COMM BLDG 253-261 HENNESSY ROAD WANCHAI HK  
CHINA

### Product Information:

Product Name: Tablet PC

Model No.: Active 8

Serial Model: N/A

Brand Name: Blackview

Report No.: AIT23052502CW4

### Prepared By:

**Dongguan Yaxu (AiT) Technology Limited**

No.22, Jinqianling Third Street, Jitigang, Huangjiang, Dongguan,  
Guangdong, China

Tel.: +86-769-8202 0499 Fax.: +86-769-8202 0495

Date of Receipt: 2023.05.25

Date of Test: 2023.05.25-2023.06.13

Date of Issue: 2023.06.14

Test Result: Pass

This device has been tested and found to comply with the stated standard(s), which is (are) required by the council directive of 2014/53/EU and indicated in the test report and are applicable only to the tested sample identified in the report.

Note: This report shall not be reproduced except in full, without the written approval of Dongguan Yaxu (AiT) Technology Limited, this document may be altered or revised by Dongguan Yaxu (AiT) Technology Limited, personal only, and shall be noted in the revision of the document. This test report must not be used by the client to claim product endorsement.

Reviewed by:



Simba huang

Approved by:



Seal.chen





**REPORT REVISE RECORD**

<b>Report Version</b>	<b>Revise Time</b>	<b>Issued Date</b>	<b>Valid Version</b>	<b>Notes</b>
V1.0	/	2023.06.14	Valid	Initial release

## TABLE OF CONTENTS

	<i>Page</i>
<b>1 TEST SUMMARY .....</b>	<b>6</b>
1.1 COMPLIANCE WITH ETSI EN 300 328 V2.2.2 (2019-07) .....	6
<b>2 TEST FACILITY .....</b>	<b>7</b>
2.1 DEVIATION FROM STANDARD .....	7
2.2 ABNORMALITIES FROM STANDARD CONDITIONS .....	7
<b>3 GENERAL INFORMATION .....</b>	<b>8</b>
3.1 GENERAL DESCRIPTION OF EUT .....	8
3.2 DESCRIPTION OF TEST SETUP .....	9
3.3 EUT PERIPHERAL LIST .....	9
3.4 TEST PERIPHERAL LIST .....	9
3.5 EQUIPMENTS LIST FOR ALL TEST ITEMS .....	10
3.6 MEASUREMENT UNCERTAINTY .....	11
<b>4 RADIO TECHNICAL REQUIREMENTS SPECIFICATION IN EN 300 328 .....</b>	<b>12</b>
4.1 TRANSMITTER CONDITIONS .....	12
4.2 TEST CONDITIONS .....	12
4.2.1 Normal conditions .....	12
4.2.2 Extreme conditions .....	12
4.3 TEST FREQUENCIES .....	13
<b>5 TRANSMITTER REQUIREMENTS .....</b>	<b>14</b>
5.1 RF OUTPUT POWER .....	14
5.1.1 Limit(ETSI EN 300 328 V2.2.2 (2019-07) Clause 4.3.1.2.3) .....	14
5.1.2 Test procedure .....	14
5.1.3 TEST SETUP .....	15
5.1.4 Test record .....	15
5.2 DUTY CYCLE, TX-SEQUENCE, TX-GAP .....	16
5.2.1 Limit(ETSI EN 300 328 V2.2.2 (2019-07) Clause 4.3.1.3.3) .....	16
5.2.2 Test procedure .....	16
5.2.3 TEST SETUP .....	16
5.2.4 Test result .....	16
5.3 DWELL TIME, MINIMUM FREQUENCY OCCUPATION AND HOPPING SEQUENCE .....	17
5.3.1 Limit(ETSI EN 300 328 V2.2.2 (2019-07) Clause 4.3.1.4.3) .....	17
5.3.2 Test procedure .....	17
5.3.3 TEST SETUP .....	19
5.3.4 Test result .....	19
5.4 MINIMUM FREQUENCY OCCUPATION .....	20
5.4.1 Limit(ETSI EN 300 328 V2.2.2 (2019-07) Clause 4.3.1.4) .....	20
5.4.2 Test procedure .....	20
5.4.3 TEST SETUP .....	20
5.4.4 Test result .....	20

5.5	HOPPING SEQUENCE .....	21
5.5.1	Limit(ETSI EN 300 328 V2.2.2 (2019-07) Clause 4.3.1.5.3) .....	21
5.5.2	Test procedure .....	21
5.5.3	TEST SETUP .....	21
5.5.4	Test result .....	21
5.6	HOPPING FREQUENCY SEPARATION .....	22
5.6.1	Limit(ETSI EN 300 328 V2.2.2 (2019-07) Clause 4.3.1.5.3) .....	22
5.6.2	Test procedure .....	22
5.6.3	TEST SETUP .....	22
5.6.4	Test result .....	23
5.7	MEDIUM UTILISATION (MU) FACTOR .....	23
5.7.1	Limit (ETSI EN 300 328 V2.2.2 (2019-07) Clause 4.3.1.6.3) .....	23
5.7.2	Test procedure .....	23
5.7.3	Test result .....	23
5.8	MEDIUM UTILISATION (MU) FACTOR .....	24
5.8.1	Limit (ETSI EN 300 328 V2.2.2 (2019-07) Clause 4.3.1.6.3) .....	24
5.8.2	Test procedure .....	24
5.8.3	Test result .....	24
5.9	ADAPTIVITY (ADAPTIVE FREQUENCY HOPPING) .....	25
5.9.1	Limit (ETSI EN 300 328 V2.2.2 (2019-07) Clause 4.3.1.7.4.2) .....	25
5.9.2	Test procedure .....	25
5.9.3	Test Setup .....	26
5.9.4	Test result .....	26
5.10	.OCCUPIED CHANNEL BANDWIDTH .....	27
5.10.1	Limit (ETSI EN 300 328 V2.2.2 (2019-07) Clause 4.3.1.8.3) .....	27
5.10.2	Test procedure .....	27
5.10.3	Test Setup .....	27
5.10.4	Test result .....	28
5.11	TRANSMITTER UNWANTED EMISSIONS IN THE OUT-OF-BAND DOMAIN .....	29
5.11.1	Limit(ETSI EN 300 328 V2.2.2 (2019-07) Clause 4.3.1.9.3) .....	29
5.11.2	Test procedure .....	29
5.11.3	Test Setup .....	31
5.11.4	Test result .....	31
5.12	.TRANSMITTER UNWANTED EMISSIONS IN THE SPURIOUS DOMAIN .....	32
5.12.1	Limit(ETSI EN 300 328 V2.2.2 (2019-07) Clause 4.3.1.10.3) .....	32
5.12.2	Test procedure .....	32
5.12.3	Test Setup .....	34
5.12.4	Radiated Test result .....	35
5.13	RECEIVER SPURIOUS EMISSIONS .....	36
5.13.1	Limit(ETSI EN 300 328 V2.2.2 (2019-07) Clause 4.3.1.11.3) .....	36
5.13.2	Test procedure .....	36
5.13.3	Test Setup .....	36
5.13.4	Test result .....	38
5.14	.RECEIVER BLOCKING .....	39
5.14.1	Performance Criteria .....	39
5.14.2	Limit(ETSI EN 300 328 V2.2.2 (2019-07) Clause 4.3.2.11.4) .....	39

---

5.14.3	Test procedure .....	40
5.14.4	Test Setup .....	41
5.14.5	Test result .....	41
<b>6</b>	<b>.APPENDIX TEST DATA .....</b>	<b>42</b>
	Appendix A. RF Output Power (E.I.R.P.) .....	42
	Appendix B. Duty cycle, Tx-Sequence, Tx-gap .....	43
	Appendix C. Dwell time, Minimum Frequency Occupation and Hopping Sequence .....	44
	Appendix D. Frequency Occupation .....	49
	Appendix E. Hopping Sequence .....	50
	Appendix F. Hopping Frequency Separation .....	51
	Appendix G. Adaptivity (Adaptive Frequency Hopping) .....	52
	Appendix H. Occupied Channel Bandwidth .....	52
	Appendix I. Transmitter unwanted emissions in the out-of-band domain .....	56
	Appendix J. Transmitter unwanted emissions in the spurious domain .....	57
	Appendix K. Receiver spurious emissions .....	63
	Appendix L. Receiver Blocking .....	67
<b>7</b>	<b>TEST SETUP PHOTOGRAP .....</b>	<b>68</b>

# 1 Test Summary

## 1.1 Compliance with ETSI EN 300 328 V2.2.2 (2019-07)

No.	Description of Test Item	Basic Standard	Results
<b>Transmitter Parameters</b>			
1	RF Output Power	EN300328 clause 4.3.1.2	Pass
2	Duty cycle, Tx-Sequence, Tx-gap	EN300328 clause 4.3.1.3	N/A
3	Dwell time	EN300328 clause 4.3.1.4	Pass
4	Minimum Frequency Occupation	EN300328 clause 4.3.1.4	Pass
5	Hopping Sequence	EN300328 clause 4.3.1.4	Pass
6	Hopping Frequency Separation	EN300328 clause 4.3.1.5	Pass
7	Medium Utilisation (MU) factor	EN300328 clause 4.3.1.6	N/A
8	Adaptivity (Adaptive Frequency Hopping)	EN300328 clause 4.3.1.7	N/A
9	Occupied Channel Bandwidth	EN300328 clause 4.3.1.8	Pass
10	Transmitter unwanted emissions in the out-of-band domain	EN300328 clause 4.3.1.9	Pass
11	Transmitter unwanted emissions in the spurious domain	EN300328 clause 4.3.1.10	Pass
12	Geo-location capability	EN 300 328 Clause 4.3.2.12.2	N/A
<b>Receiver Parameters</b>			
13	Receiver spurious emissions	EN300328 clause 4.3.1.11	Pass
14	Receiver Blocking	EN300328 clause 4.3.1.12	Pass
N/A: not applicable. Refer to the relevant section for the details.			
EN 300 328: the detail version is ETSI EN 300 328 V2.2.2 (2019-07) in the whole report.			
Tx: In this whole report Tx (or tx) means Transmitter. Rx: In this whole report Rx (or rx) means Receiver. RF: In this whole report RF means Radio Frequency. The EUT belongs to the list of 'Class-1' equipment in accordance with the Commission Decision 2000/299/EC (6 April 2000). Temperature (Uncertainty): $\pm 1^{\circ}\text{C}$ Humidity (Uncertainty): $\pm 5\%$			

## 2 Test Facility

**The test facility is recognized, certified or accredited by the following organizations:**

**.CNAS- Registration No: L6177**

Dongguan Yaxu (AiT) technology Limited is accredited to ISO/IEC 17025:2017 general Requirements for the competence of testing and calibration laboratories (CNAS-CL01 Accreditation Criteria for the competence of testing and calibration laboratories) on April 17, 2022

**FCC-Registration No.: 703111 Designation Number: CN1313**

Dongguan Yaxu (AiT) technology Limited has been registered and fully described in a report filed with the (FCC) Federal Communications Commission. The acceptance letter from the FCC is maintained in our files.

**IC —Registration No.: 6819A CAB identifier: CN0122**

The 3m Semi-anechoic chamber of Dongguan Yaxu (AiT) technology Limited has been registered by Certification and Engineering Bureau of Industry Canada for radio equipment testing with Registration No.: 6819A

**A2LA-Lab Cert. No.: 6317.01**

Dongguan Yaxu (AiT) technology Limited has been accredited by A2LA for technical competence in the field of electrical testing, and proved to be in compliance with ISO/IEC 17025: 2017 General Requirements for the Competence of Testing and Calibration Laboratories and any additional program requirements in the identified field of testing.

### 2.1 Deviation from Standard

None

### 2.2 Abnormalities from Standard Conditions

None

### 3 General Information

#### 3.1 General Description of EUT

Manufacturer	Shenzhen DOKE Electronic Co., Ltd
Manufacturer Address	801, Building3, 7th Industrial Zone, Yulv Community, Yutang Road, Guangming District, Shenzhen, China
EUT Name	Tablet PC
Model No.	Active 8
Serial Model	N/A
Difference Description	N/A
Brand Name:	Blackview
Operation Frequency:	2402 MHz to 2480 MHz
Modulation Type	GFSK, $\pi/4$ -DQPSK, 8DPSK
The number of Hopping Frequencies	79
Bluetooth Version	V5.0
Antenna Designation	FPC Antenna
Antenna Gain	1.20dBi
Hardware Version	DK051-T616-V1.0
Software Version	Active8_EEA_T30_V1.0
Power Supply	DC 3.87V 22000mAh for Battery
Maximum Output Power	3.17dBm

Note:

1.For a more detailed features description, please refer to the manufacturer’s specifications or the User's Manual.



### 3.2 Description of Test setup

EUT was tested in normal configuration (Please See following Block diagrams)

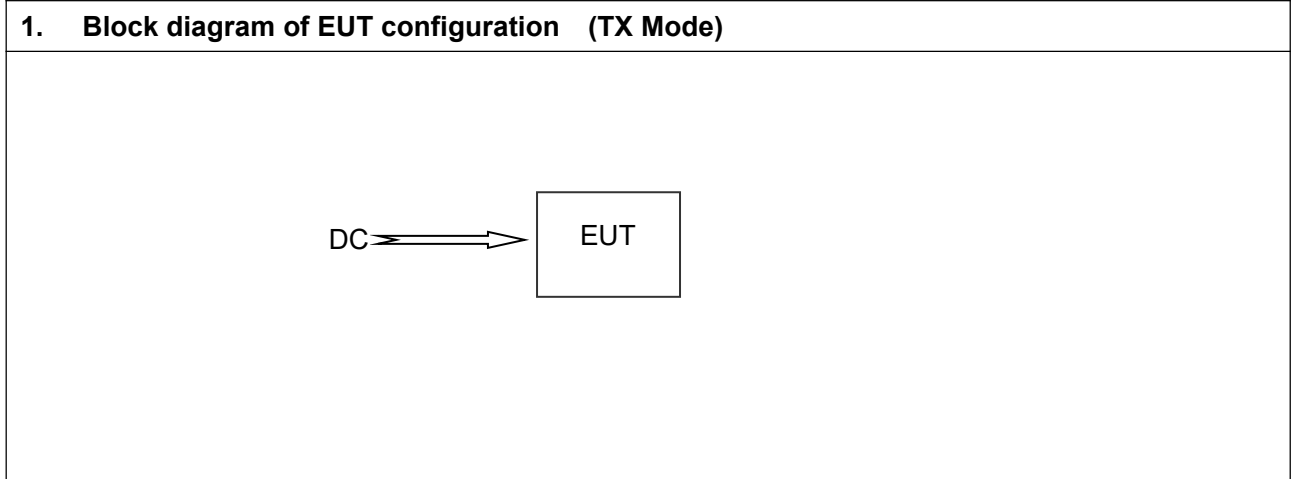

### 3.3 EUT Peripheral List

No.	Equipment	Manufacturer	EMC Compliance	Model No.	Serial No.	Power cord	signal cable
1	--	--	--	--	N/A	N/A	N/A

### 3.4 Test Peripheral List

No.	Equipment	Manufacturer	EMC Compliance	Model No.	Serial No.	Power cord	signal cable
1	PC	DELL	--	E7430	N/A	N/A	N/A

### 3.5 Equipments List for All Test Items

No	Test Equipment	Manufacturer	Model No	Serial No	Cal. Date	Cal. Due Date
1	Spectrum Analyzer	R&S	FSV40	101470	2022.09.02	2023.09.01
2	EMI Measuring Receiver	R&S	ESR	101160	2022.09.02	2023.09.01
3	Low Noise Pre Amplifier	HP	HP8447E	AiT-F01319	2022.09.02	2023.09.01
4	Low Noise Pre Amplifier	Tsj	MLA-0120-A02-34	2648A04738	2022.09.02	2023.09.01
5	Passive Loop	ETS	6512	00165355	2022.09.04	2024.09.03
6	TRILOG Super Broadband test Antenna	SCHWARZBECK	VULB9160	9160-3206	2021.08.29	2024.08.28
7	Broadband Horn Antenna	SCHWARZBECK	BBHA9120D	452	2021.08.29	2024.08.28
8	SHF-EHF Horn Antenna 15-40GHz	SCHWARZBECK	BBHA9170	BBHA9170367d	2020.11.24	2023.11.23
9	EMI Test Receiver	R&S	ESCI	100124	2022.09.02	2023.09.01
10	LISN	Kyoritsu	KNW-242	8-837-4	2022.09.02	2023.09.01
11	LISN	R&S	ESH3-Z2	0357.8810.54-101161-S2	2022.09.02	2023.09.01
12	Pro.Temp&Humi.chamber	MENTEK	MHP-150-1C	MAA08112501	2022.09.02	2023.09.01
13	RF Automatic Test system	MW	MW100-RFCB	21033016	2022.09.02	2023.09.01
14	Signal Generator	Agilent	N5182A	MY50143009	2022.09.02	2023.09.01
15	Wideband Radio communication tester	R&S	CMW500	1201.0002K50	2022.09.02	2023.09.01
16	RF Automatic Test system	MW	MW100-RFCB	21033016	2022.09.02	2023.09.01
17	DC power supply	ZHAOXIN	RXN-305D-2	28070002559	N/A	N/A
18	RE Software	EZ	EZ-EMC_RE	Ver.AIT-03A	N/A	N/A
19	CE Software	EZ	EZ-EMC_CE	Ver.AIT-03A	N/A	N/A
20	RF Software	MW	MTS 8310	2.0.0.0	N/A	N/A

### 3.6 Measurement Uncertainty

No.	Item	Uncertainty
1	Conducted Emission Test	1.20dB
2	Radiated Emission Test	3.30dB
3	RF power,conducted	0.16dB
4	RF power density,conducted	0.24dB
5	Spurious emissions,conducted	0.21dB
6	All emissions,radiated(<1G)	4.68dB
7	All emissions,radiated(>1G)	4.89dB

## 4 Radio Technical Requirements Specification in EN 300 328

### 4.1 Transmitter Conditions

Item	EUT Type
1	stand-alone radio equipment with or without their own control provisions;
2	plug-in radio devices intended for use with or within a variety of host systems, e.g. personal computers, hand-held terminals, etc.;
3	plug-in radio devices intended for use within combined equipment, e.g. cable modems, set-top boxes, access points, etc.;
4	Combined equipment or a combination of a plug-in radio device and a specific type of host equipment.

Modulation
FHSS

EUT belongs to item 1 with FHSS modulation.

### 4.2 Test conditions

#### 4.2.1 Normal conditions

Ambient:	Temperature:	+15°C to +35°C
	Relative humidity:	20% to 75%
	Press:	1010 mbar
Power supply:	DC	3.87V

#### 4.2.2 Extreme conditions

Ambient:	Temperature:	-10 °C to +50 °C (Which declared by manufacture )
Power supply:	DC	3.28V ~4.45V

### 4.3 Test frequencies

EUT channels and frequencies list:

Description of Channel:					
Channel	Frequency (MHz)	Channel	Frequency (MHz)	Channel	Frequency (MHz)
00	2402	27	2429	54	2456
01	2403	28	2430	55	2457
02	2404	29	2431	56	2458
03	2405	30	2432	57	2459
04	2406	31	2433	58	2460
05	2407	32	2434	59	2461
06	2408	33	2435	60	2462
07	2409	34	2436	61	2463
08	2410	35	2437	62	2464
09	2411	36	2438	63	2465
10	2412	37	2439	64	2466
11	2413	38	2440	65	2467
12	2414	39	2441	66	2468
13	2415	40	2442	67	2469
14	2416	41	2443	68	2470
15	2417	42	2444	69	2471
16	2418	43	2445	70	2472
17	2419	44	2446	71	2473
18	2420	45	2447	72	2474
19	2421	46	2448	73	2475
20	2422	47	2449	74	2476
21	2423	48	2450	75	2477
22	2424	49	2451	76	2478
23	2425	50	2452	77	2479
24	2426	51	2453	78	2480
25	2427	52	2454	--	--
26	2428	53	2455	--	--

Test frequencies are the lowest channel: 0 channel(2402MHz), middle channel: 39 channel(2441 MHz) and highest channel: 78 channel(2480 MHz)

## 5 Transmitter Requirements

### 5.1 RF Output Power

#### 5.1.1 Limit(ETSI EN 300 328 V2.2.2 (2019-07) Clause 4.3.1.2.3)

##### **For non-adaptive frequency hopping systems**

The maximum RF output power for non-adaptive Frequency Hopping equipment, shall be declared by the supplier. The maximum RF output power for this equipment shall be equal to or less than the value declared by the supplier. This declared value shall be equal to or less than 20dBm.

##### **For adaptive frequency hopping systems**

The maximum RF output power for adaptive Frequency Hopping equipment shall be equal to or less than 20dBm.

#### 5.1.2 Test procedure

ETSI EN 300 328 V2.2.2 (2019-07) Clause 5.4.2

1. Remove the antenna from the EUT and then connect a low attenuation RF cable from the antenna port to the spectrum.
2. Use a fast power sensor suitable for 2, 4 GHz and capable of 1 MS/s.
3. Sample speed 1 MS/s or faster, and must represent the power of the signal.
4. For adaptive equipment, the measurement duration shall be long enough to ensure a minimum number of bursts (at least 10) are captured.
5. For conducted measurements on devices with one transmit chain:
  - Connect the power sensor to the transmit port, sample the transmit signal and store the raw data. use these stored samples in all following steps.
6. For conducted measurements on devices with multiple transmit chains:
  - Connect one power sensor to each transmit port for a synchronous measurement on all transmits ports.
  - Trigger the power sensors so that they start sampling at the same time. Make sure the time difference between the samples of all sensors is less than half the time between two samples.
  - For each instant in time, sum the power of the individual samples of all ports and store them. Use these stored samples in all following steps.
7. Find the start and stop times of each burst in the stored measurement samples.
8. Between the start and stop times of each individual burst calculate the RMS power over the burst. Save these Pburst values, as well as the start and stop times for each burst.

9. The highest of all Pburst values (value "A" in dBm) will be used for maximum e.i.r.p. calculations.
  10. Add the (stated) antenna assembly gain "G" in dBi of the individual antenna, If applicable, add the additional beamforming gain "Y" in dB.
  11. If more than one antenna assembly is intended for this power setting, the maximum overall antenna gain (G or G + Y) shall be used.
  12. The RF Output Power (P) shall be calculated using the formula below:  $P = A + G + Y$
- Keep the EUT in transmitting at lowest, middle and highest channel individually. Record the max value.

### EUT Operation

Status: Enter test mode for the product, keep EUT in continuously transmitting status with hoping on mode.

Conducted measurement for this kind of products which be used for integral antenna equipment connect to the measuring equipment.

Test the EUT in normal mode and EDR mode.

Pre-test the EUT in AC mode and B/O mode, find worse case in B/O mode.

### 5.1.3 TEST SETUP

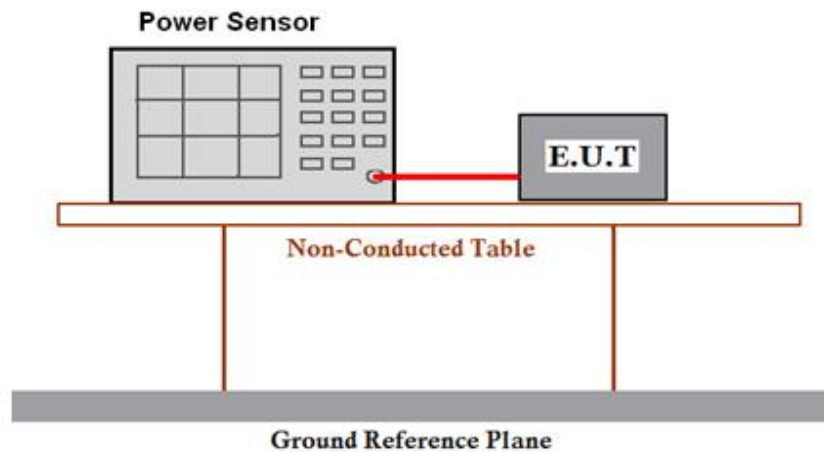

### 5.1.4 Test record

Note: For test data, please refer to the appendix results.

## 5.2 Duty cycle, Tx-Sequence, Tx-gap

### 5.2.1 Limit(ETSI EN 300 328 V2.2.2 (2019-07) Clause 4.3.1.3.3)

For non-adaptive FHSS equipment, the Duty Cycle shall be equal to or less than the maximum value declared by the supplier. In addition, the maximum Tx-sequence time shall be 5 ms while the minimum Tx-gap time shall be 5 ms.

### 5.2.2 Test procedure

Refer to ETSI EN 300 328 V2.2.2 (2019-07) Clause 5.4.2

### 5.2.3 TEST SETUP



### 5.2.4 Test result

Note: For test data, please refer to the appendix results.

No applicable.

Refer to the EN 300 328 clause 4.3.1.3.1 section for the details.

These requirements apply to non-adaptive frequency hopping equipment or to adaptive frequency hopping equipment operating in a non-adaptive mode.

These requirements do not apply for equipment with a maximum declared RF Output power of less than 10 dBm e.i.r.p. or for equipment when operating in a mode where the RF Output power is less than 10 dBm e.i.r.p.

As the EUT belongs to Adaptive equipment type, so the test is not applicable and skipped.



## 5.3 Dwell time, Minimum Frequency Occupation and Hopping Sequence

### 5.3.1 Limit(ETSI EN 300 328 V2.2.2 (2019-07) Clause 4.3.1.4.3)

The maximum accumulated dwell time on any hopping frequency shall be 400 ms within any period of 400 ms multiplied by the minimum number of hopping frequencies (N) that have to be used.

### 5.3.2 Test procedure

Refer to ETSI EN 300 328 V2.2.2 (2019-07) Clause 5.4.2

1. Remove the antenna from the EUT and then connect a low RF cable from the antenna port to the spectrum.

The analyzer shall be set as follows:

- Centre Frequency: Equal to the hopping frequency being investigated
- Frequency Span: 0 Hz
- RBW: ~ 50 % of the Occupied Channel Bandwidth
- VBW:  $\geq$  RBW
- Detector Mode: RMS
- Sweep time: Equal to the Dwell Time  $\times$  Minimum number of hopping frequencies (N)  
(see clause 4.3.1.4.2)
- Number of sweep points: 30 000
- Trace mode: Clear / Write
- Trigger: Free Run

2. Save the trace data to a file for further analysis by a computing device using an appropriate software application or program.

3. Identify the data points related to the frequency being investigated by applying a threshold. The data points resulting from transmissions on the hopping frequency being investigated are assumed to have much higher levels compared to data points resulting from transmissions on adjacent hopping frequencies. If a clear determination between these transmissions is not possible, the RBW in step 1 shall be further reduced.

In addition, a channel filter may be used, Count the number of data points identified as resulting from transmissions on the frequency being investigated and multiply this number by the time difference between two consecutive data points.

4. The result in step 3 is the accumulated Dwell Time which shall comply with the limit provided in clauses 4.3.1.3.2.1 or 4.3.1.3.2.2 and which shall be recorded in the test report.

5. Make the following changes on the analyzer and repeat steps 2 and 3. Sweep time:  $4 \times \text{Dwell Time} \times \text{Actual number of hopping frequencies in use}$ .

The hopping frequencies occupied by the system without having transmissions during the dwell time (blacklisted frequencies) should be taken into account in the actual number of hopping frequencies in use. If this number can not be determined (number of blacklisted frequencies unknown) it shall be assumed that the equipment uses the minimum number of hopping frequencies as defined in clauses 4.3.1.4.2.1 or 4.3.1.4.2.2. The result shall be compared to the limit for the Minimum Frequency Occupation Time defined in clauses 4.3.1.3.2.1 or 4.3.1.3.2.2. This value shall be recorded in the test report.

6. Make the following changes on the analyzer:

- Start Frequency: 2 400 MHz
  - Stop Frequency: 2 483,5 MHz
  - RBW: ~ 50 % of the Occupied Channel Bandwidth (single hop)
  - VBW:  $\geq$  RBW
  - Detector Mode: RMS
  - Sweep time: Auto
  - Trace Mode: Max Hold
  - Trigger: Free Run
- When the trace has completed, identify the number of hopping frequencies used by the hopping sequence.
  - The result shall be compared to the limit (value N) defined in clauses 4.3.1.3.2.1 or 4.3.1.3.2.2. This value shall be recorded in the test report.

For equipment with blacklisted frequencies, it might not be possible to verify the number of hopping frequencies in use. However they shall comply with the requirement for accumulated Dwell time and Minimum Frequency Occupation Time assuming the minimum number of hopping frequencies defined in clauses 4.3.1.3.2.1 or 4.3.1.3.2.2 are in use.

7. For adaptive systems, using the lowest and highest -20 dB points from the total spectrum envelope obtained in step 6, it shall be verified whether the system uses 70 % of the band specified in clause 1. The result shall be recorded in the test report.

Use the marker-delta function to determine the dwell time. If this value varies with different modes of operation (e.g., data rate, modulation format, etc.). Repeat this test for each variation. The limit is specified in one of the subparagraphs of this Section. Submit this plot(s). An oscilloscope may be used instead of a spectrum analyzer.

#### **EUT Operation:**

Test Status: Enter test mode for the product, keep EUT in continuously transmitting status with hopping on mode with different packages; find the worst case is GFSK & 8DPSK mode.  
Pre-test the EUT in AC mode and B/O mode, find worse case in B/O mode.

### **5.3.3 TEST SETUP**

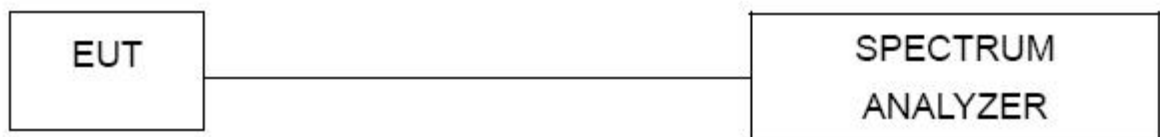

### **5.3.4 Test result**

Note: For test data, please refer to the appendix results.

## 5.4 Minimum Frequency Occupation

### 5.4.1 Limit(ETSI EN 300 328 V2.2.2 (2019-07) Clause 4.3.1.4)

The Minimum Frequency Occupation Time shall be equal to one dwell time within a period not exceeding four times the product of the dwell time per hop and the number of hopping frequencies in use.

### 5.4.2 Test procedure

Refer to ETSI EN 300 328 V2.2.2 (2019-07) Clause 5.2.2

#### EUT Operation:

Test Status: Enter test mode for the product, keep EUT in continuously transmitting status with hopping on mode with different packages; find the worst case is 8DPSK mode.  
Pre-test the EUT in AC mode and B/O mode, find worse case in B/O mode.

### 5.4.3 TEST SETUP

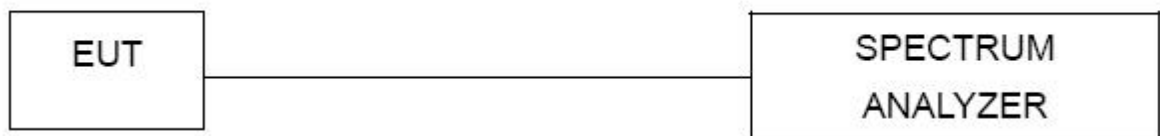

### 5.4.4 Test result

Note: For test data, please refer to the appendix results.

## 5.5 Hopping Sequence

### 5.5.1 Limit(ETSI EN 300 328 V2.2.2 (2019-07) Clause 4.3.1.5.3)

The hopping sequence(s) shall contain at least N hopping frequencies at all times, where N is 15 or 15 divided by the minimum Hopping Frequency Separation in MHz, whichever is the greater.

### 5.5.2 Test procedure

Refer to ETSI EN 300 328 V2.2.2 (2019-07) Clause 5.3.4

#### EUT Operation:

Test Status: Enter test mode for the product, keep EUT in continuously transmitting status with hopping on mode with different packages; find the worst case is 8DPSK mode.

Pre-test the EUT in AC mode and B/O mode, find worse case in B/O mode.

### 5.5.3 TEST SETUP

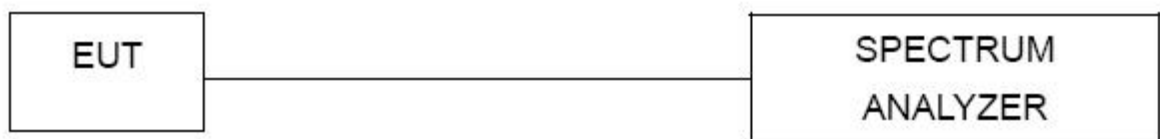

### 5.5.4 Test result

Note: For test data, please refer to the appendix results.

## 5.6 Hopping Frequency Separation

### 5.6.1 Limit(ETSI EN 300 328 V2.2.2 (2019-07) Clause 4.3.1.5.3)

Non-adaptive frequency hopping systems

The minimum Hopping Frequency Separation shall be equal to Occupied Channel Bandwidth (see clause 4.3.1.7) of a single hop, with a minimum separation of 100 kHz.

Adaptive frequency hopping systems

The minimum Hopping Frequency Separation shall be 100 kHz.

### 5.6.2 Test procedure

Refer to ETSI EN 300 328 V2.2.2 (2019-07) Clause 5.4.5

Remove the antenna from the EUT and then connect a low RF cable from the antenna port to the spectrum.

The analyzer shall be set as follows:

- Centre Frequency: Centre of the two adjacent hopping frequencies
- Frequency Span: Sufficient to see the complete power envelope of both hopping frequencies
- RBW: 1 % of the Span
- VBW: 3 × RBW
- Detector Mode: RMS
- Trace Mode: Max Hold
- Sweep Time: Auto
- Allow the trace to stabilize.
- Use the marker-delta function to determine the Hopping Frequency Separation between the peaks of the two adjacent hopping frequencies. This value shall be compared with the limits defined in clause 4.3.1.5.3 and shall be recorded in the test report.

#### EUT Operation:

Test Status: Test the EUT in hopping mode.  
Pre-test the EUT in AC mode and B/O mode, find worse case in B/O mode.

### 5.6.3 TEST SETUP



#### **5.6.4 Test result**

Note: For test data, please refer to the appendix results.

### **5.7 Medium Utilisation (MU) factor**

#### **5.7.1 Limit (ETSI EN 300 328 V2.2.2 (2019-07) Clause 4.3.1.6.3)**

##### **For non-adaptive equipment**

The maximum Medium Utilisation factor for non-adaptive Frequency Hopping equipment shall be 10 %.

#### **5.7.2 Test procedure**

Refer to ETSI EN 300 328 V2.2.2 (2019-07)

#### **5.7.3 Test result**

Note: For test data, please refer to the appendix results.

##### **No applicable.**

This requirement does not apply to adaptive equipment unless operating in a non-adaptive mode.

In addition, this requirement does not apply for equipment with a maximum declared RF Output power level of less than 10dBm E.I.R.P. or for equipment when operating in a mode where the RF Output power is less than 10dBm E.I.R.P.

## **5.8 Medium Utilisation (MU) factor**

### **5.8.1 Limit (ETSI EN 300 328 V2.2.2 (2019-07) Clause 4.3.1.6.3)**

#### **For non-adaptive equipment**

The maximum Medium Utilisation factor for non-adaptive Frequency Hopping equipment shall be 10 %.

### **5.8.2 Test procedure**

Refer to ETSI EN 300 328 V2.2.2 (2019-07)

### **5.8.3 Test result**

Note: For test data, please refer to the appendix results.

#### **No applicable.**

This requirement does not apply to adaptive equipment unless operating in a non-adaptive mode.

In addition, this requirement does not apply for equipment with a maximum declared RF Output power level of less than 10dBm E.I.R.P. or for equipment when operating in a mode where the RF Output power is less than 10dBm E.I.R.P.



## 5.9 Adaptivity (Adaptive Frequency Hopping)

### 5.9.1 Limit (ETSI EN 300 328 V2.2.2 (2019-07) Clause 4.3.1.7.4.2)

#### Adaptivity Limit

Non-LBT based Detect and Avoid

The channel shall remain unavailable for a minimum time equal to 1 s after which the channel may be considered again as an 'available' channel;

COT  $\leq$  40 ms;

Idle Period shall be minimum 5% of COT with a minimum of 100us;

Detection threshold level = -70dBm/MHz + 20 – Pout E.I.R.P (Pout in dBm); LBT based Detect and Avoid(Frame Based Equipment)

The CCA observation time shall be not less than 20 us;

The CCA time used by the equipment shall be declared by the supplier;

COT = 1-10 ms;

Idle Period = 5% of COT;

Detection threshold level = -70dBm/MHz + 20 – Pout E.I.R.P (Pout in dBm); LBT based Detect and Avoid(Load Based Equipment)

The CCA observation time shall be not less than 20 us;

The CCA time used by the equipment shall be declared by the supplier;

COT  $\leq$  (13 / 32) \* q ms; q = [4~32]; 1.625ms~13ms;

R = number of clear idle slots are randomly [1~q]. Every time an Extended CCA is required and the 'R' value stored in a counter.

Detection threshold level = -70dBm/MHz + 20 – Pout E.I.R.P (Pout in dBm); Short Control Signalling Transmissions:

Short Control Signalling Transmissions shall have a maximum duty cycle of 10% within an observation period of 50ms.

### 5.9.2 Test procedure

Refer to ETSI EN 300 328 V2.2.2 (2019-07) Clause 5.4.6

### 5.9.3 Test Setup

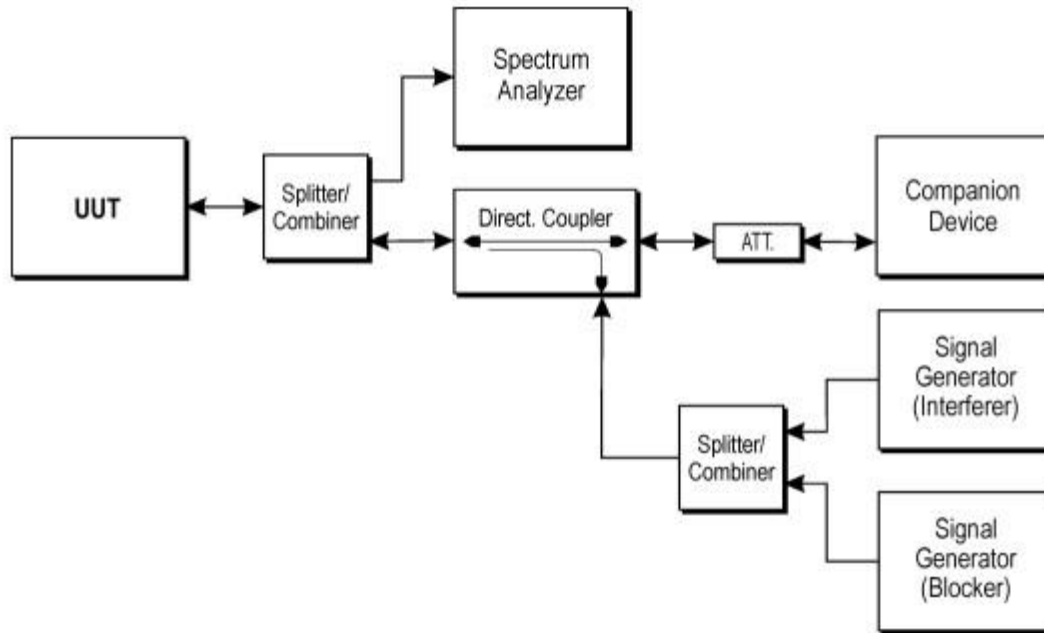

### 5.9.4 Test result

Note: For test data, please refer to the appendix results.

#### No applicable.

Adaptivity (Adaptive Frequency Hopping)

This requirement does not apply to non-adaptive equipment or adaptive equipment operating in a non-adaptive mode providing the equipment complies with the requirements and/or restrictions applicable to non-adaptive equipment.

In addition, this requirement does not apply for equipment with a maximum declared RF Output power level of less than 10 dBm e.i.r.p. or for equipment when operating in a mode where the RF Output power is less than 10 dBm e.i.r.p.

As the EUT about RF Output power level is less than 10 dBm e.i.r.p, so the test is not applicable and skipped.

## 5.10.Occupied Channel Bandwidth

### 5.10.1Limit (ETSI EN 300 328 V2.2.2 (2019-07) Clause 4.3.1.8.3)

For non-adaptive Frequency Hopping equipment with E.I.R.P greater than 10dBm, the Occupied Channel Bandwidth for every occupied hopping frequency shall be equal to or less than the value declared by the supplier. This declared value shall not be greater than 5 MHz.

### 5.10.2Test procedure

Refer to ETSI EN 300 328 V2.2.2 (2019-07) Clause 5.4.7

1. Remove the antenna from the EUT and then connect a low attenuation RF cable from the antenna port to the spectrum and use the following settings:
  - Centre Frequency: The centre frequency of the channel under test
  - Resolution BW: ~ 1 % of the span without going below 1 %
  - Video BW: 3 × RBW
  - Frequency Span: 2 × Occupied Channel Bandwidth (e.g. 40 MHz for a 20 MHz channel)
  - Detector Mode: RMS
  - Trace Mode: Max Hold
2. Wait until the trace is completed, Find the peak value of the trace and place the analyser marker on this peak.
3. Use the 99 % bandwidth function of the spectrum analyser to measure the Occupied Channel Bandwidth of the UUT, this value shall be recorded.

NOTE: Make sure that the power envelope is sufficiently above the noise floor of the analyser to avoid the noise signals left and right from the power envelope being taken into account by this measurement.

#### EUT Operation

Status: Enter test mode for the product. Test in Channel lowest (2402MHz), highest (2480MHz), keep in continuously transmitting status on a single Hopping Frequency.

Test the EUT in normal mode and EDR mode.

Pre-test the EUT in AC mode and B/O mode, find worse case in B/O mode.

### 5.10.3Test Setup



#### **5.10.4 Test result**

Note: For test data, please refer to the appendix results.

## 5.11 Transmitter unwanted emissions in the out-of-band domain

### 5.11.1 Limit(ETSI EN 300 328 V2.2.2 (2019-07) Clause 4.3.1.9.3)

The transmitter unwanted emissions in the out-of-band domain but outside the allocated band, shall not exceed the values provided by the mask.

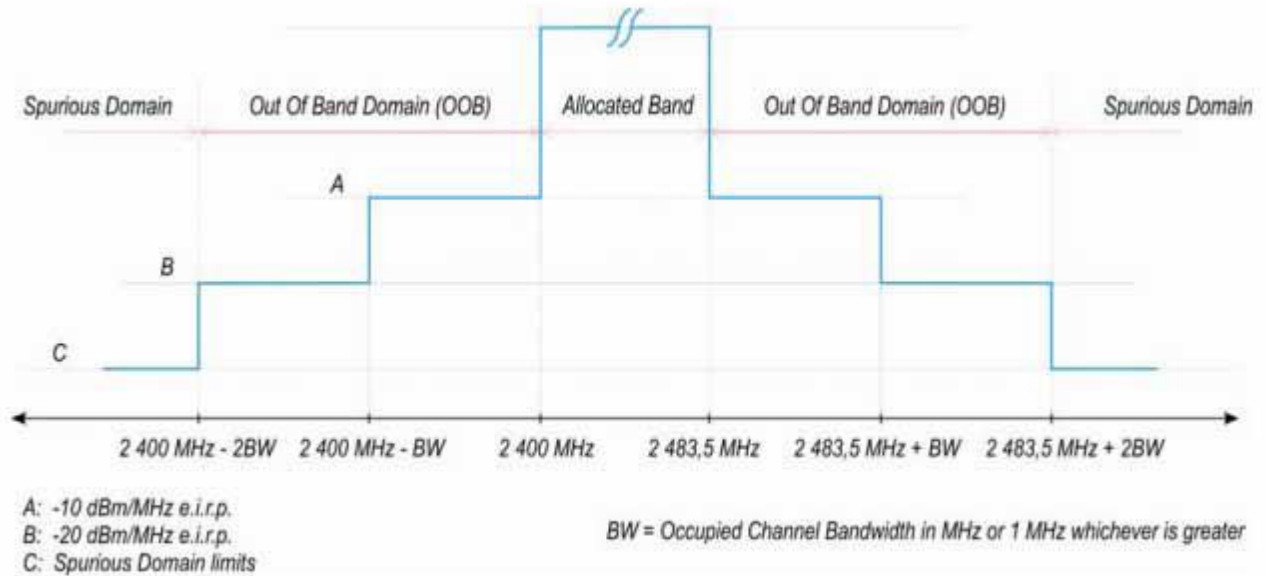

### 5.11.2 Test procedure

Refer to ETSI EN 300 328 V2.2.2 (2019-07) Clause 5.4.8

1. Remove the antenna from the EUT and then connect a low attenuation RF cable from the antenna port to the spectrum and use the following settings:
  - Centre Frequency: 2 484 MHz
  - Span: 0 Hz
  - Resolution BW: 1 MHz
  - Filter mode: Channel filter
  - Video BW: 3 MHz
  - Detector Mode: RMS
  - Trace Mode: Clear / Write
  - Sweep Mode: Continuous
  - Sweep Points: 5 000
  - Trigger Mode: Video trigger

NOTE 1: In case video triggering is not possible, an external trigger source may be used.

- Sweep Time: Suitable to capture one transmission burst
2. segment 2 483,5 MHz to 2 483,5 MHz + BW
    - Adjust the trigger level to select the transmissions with the highest power level.
    - For frequency hopping equipment operating in a normal hopping mode, the different hops will result in signal bursts with different power levels. In this case the burst with the highest power level shall be selected.

- Set a window (start and stop lines) to match with the start and end of the burst and in which the RMS power shall be measured using the Time Domain Power function.
  - Select RMS power to be measured within the selected window and note the result which is the RMS power within this 1 MHz segment (2 483,5 MHz to 2 484,5 MHz). Compare this value with the applicable limit provided by the mask.
  - Increase the centre frequency in steps of 1 MHz and repeat this measurement for every 1 MHz segment within the range 2 483,5 MHz to 2 483,5 MHz + BW. The centre frequency of the last 1 MHz segment shall be set to 2 483,5 MHz + BW - 0,5 MHz (which means this may partly overlap with the previous 1 MHz segment).
3. segment 2 483,5 MHz + BW to 2 483,5 MHz + 2BW
    - Change the centre frequency of the analyser to 2 484 MHz + BW and perform the measurement for the first 1 MHz segment within range 2 483,5 MHz + BW to 2 483,5 MHz + 2BW. Increase the centre frequency in 1 MHz steps and repeat the measurements to cover this whole range. The centre frequency of the last 1 MHz segment shall be set to 2 483,5 MHz + 2 BW - 0,5 MHz.
  4. segment 2 400 MHz - BW to 2 400 MHz
    - Change the centre frequency of the analyser to 2 399,5 MHz and perform the measurement for the first 1 MHz segment within range 2 400 MHz - BW to 2 400 MHz Reduce the centre frequency in 1 MHz steps and repeat the measurements to cover this whole range. The centre frequency of the last 1 MHz segment shall be set to 2 400 MHz - 2BW + 0,5 MHz.
  5. segment 2 400 MHz - 2BW to 2 400 MHz - BW
    - Change the centre frequency of the analyser to 2 399,5 MHz - BW and perform the measurement for the first 1 MHz segment within range 2 400 MHz - 2BW to 2 400 MHz - BW. Reduce the centre frequency in 1 MHz steps and repeat the measurements to cover this whole range. The centre frequency of the last 1 MHz segment shall be set to 2 400 MHz - 2BW + 0,5 MHz.
  6. In case of conducted measurements on equipment with a single transmit chain, the declared antenna assembly gain "G" in dBi shall be added to the results for each of the 1 MHz segments and compared with the limits provided by the mask given in figures 1 or 3. If more than one antenna assembly is intended for this power setting, the antenna with the highest gain shall be considered.
    - In case of conducted measurements on smart antenna systems (equipment with multiple transmit chains), the measurements need to be repeated for each of the active transmit chains. The declared antenna assembly gain "G" in dBi for a single antenna shall be added to these results. If more than one antenna assembly is intended for this power setting, the antenna with the highest gain shall be considered. Comparison with the applicable limits shall be done using any of the options given below:
      - Option 1: the results for each of the transmit chains for the corresponding 1 MHz segments shall be added. The additional beamforming gain "Y" in dB shall be added as well and the resulting values compared with the limits provided by the mask given in figures 1 or 3.
      - Option 2: the limits provided by the mask given in figures 1 or 3 shall be reduced by  $10 \times \log 10(\text{Ach})$  and the additional beamforming gain "Y" in dB. The results for each of the transmit chains shall be individually compared with these reduced limits.
- NOTE 2: Ach refers to the number of active transmit chains.
- It shall be recorded whether the equipment complies with the mask provided in figures 1 or 3.

### EUT Operation

Status: Enter test mode for the product, keep EUT in continuously transmitting status with hoping on mode with different packages; find the worst case is GFSK, 8DPSK mode.  
 Pre-test the EUT in AC mode and B/O mode, find worse case in B/O mode.

### 5.11.3 Test Setup

For Conducted Measurement

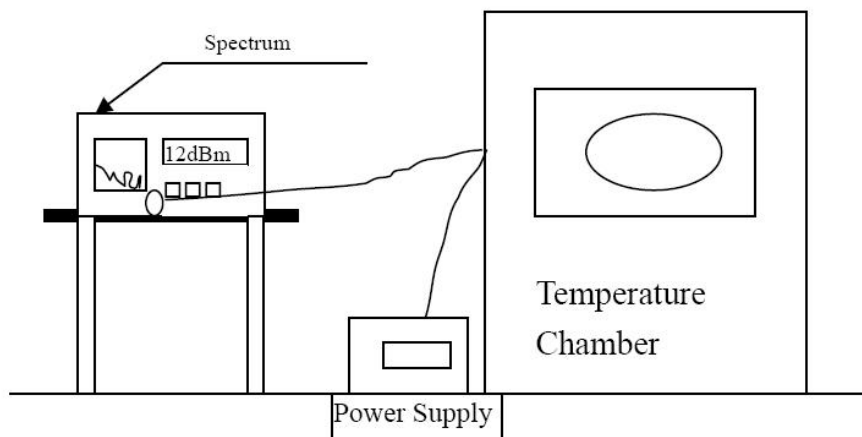

### 5.11.4 Test result

Note: For test data, please refer to the appendix results.

## 5.12. Transmitter unwanted emissions in the spurious domain

### 5.12.1 Limit(ETSI EN 300 328 V2.2.2 (2019-07) Clause 4.3.1.10.3)

The transmitter unwanted emissions in the spurious domain shall not exceed the values given in table 1.

**Table 1: Transmitter limits for spurious emissions**

Frequency range	Maximum power, e.r.p. ( $\leq 1$ GHz) e.i.r.p. ( $> 1$ GHz)	Bandwidth
30 MHz to 47 MHz	-36 dBm	100KHz
47 MHz to 74 MHz	-54 dBm	100KHz
74 MHz to 87,5 MHz	-36 dBm	100KHz
87,5 MHz to 118 MHz	-54 dBm	100KHz
118 MHz to 174 MHz	-36 dBm	100KHz
174 MHz to 230 MHz	-54 dBm	100KHz
230 MHz to 470 MHz	-36 dBm	100KHz
470 MHz to 694 MHz	-54 dBm	100KHz
694 MHz to 1GHz	-36 dBm	100KHz
1 GHz to 12,75 GHz	-30 dBm	1 MHz

### 5.12.2 Test procedure

Refer to ETSI EN 300 328 V2.2.2 (2019-07) Clause 5.4.9

Substitution method was performed to determine the actual spurious emission levels of the EUT.

The following test procedure as below:

1)Below 1GHz test procedure:

1. On the test site as test setup graph above, the EUT shall be placed at the 1.5m support on the turntable and in the position closest to normal use as declared by the provider.
2. The test antenna shall be oriented initially for vertical polarization and shall be chosen to correspond to the test frequency of the transmitter. The output of the test antenna shall be connected to the measuring receiver.
3. The transmitter shall be switched on, if possible, without modulation and the measuring receiver shall be tuned to the test frequency of the transmitter under test.
4. The test antenna shall be raised and lowered from 1m to 4m until a maximum signal level is detected by the measuring receiver. Then the turntable should be rotated through 360° in the horizontal plane, until the maximum signal level is detected by the measuring receiver.
5. Repeat step 4 for test frequency with the test antenna polarized horizontally.
6. Remove the transmitter and replace it with a substitution antenna (the antenna should be half-wavelength for each frequency involved). The center of the substitution antenna should be approximately at the same location as the center of the transmitter. At the lower frequencies, where the substitution antenna is very long, this will be impossible to achieve when the antenna is polarized vertically. In such case the lower end of the antenna should be 0.3 m above the ground.



7. Feed the substitution antenna at the transmitter end with a signal generator connected to the antenna by means of a nonradiating cable. With the antennas at both ends vertically polarized, and with the signal generator tuned to a particular test frequency, raise and lower the test antenna to obtain a maximum reading at the spectrum analyzer. Adjust the level of the signal generator output until the previously recorded maximum reading for this set of conditions is obtained. This should be done carefully repeating the adjustment of the test antenna and generator output.
8. Repeat step 7 with both antennas horizontally polarized for each test frequency.
9. Calculate power in dBm into a reference ideal half-wave dipole antenna by reducing the readings obtained in steps 7 and 8 by the power loss in the cable between the generator and the antenna, and further corrected for the gain of the substitution antenna used relative to an ideal half-wave dipole antenna by the following formula:

$$\text{ERP(dBm)} = \text{Pg(dBm)} - \text{cable loss (dB)} + \text{antenna gain (dBd)}$$

where:

Pg is the generator output power into the substitution antenna.

2) above 1GHz test procedure:

1. Different between above is the test site, change from Semi- Anechoic Chamber to fully Anechoic Chamber, and the test antenna do not need to raise from 1 to 4m, just test in 1.5m height.

#### **EUT Operation:**

Status: Enter test mode for the product. Test in Channel lowest (2402MHz) and highest (2480MHz); keep in continuously transmitting mode on a single Hopping Frequency. Pretest the EUT in normal mode and EDR mode, the worse case is EDR mode, compliance the worse case and reported it. Pre-test the EUT in AC mode and B/O mode, find worse case in B/O mode.

### 5.12.3 Test Setup

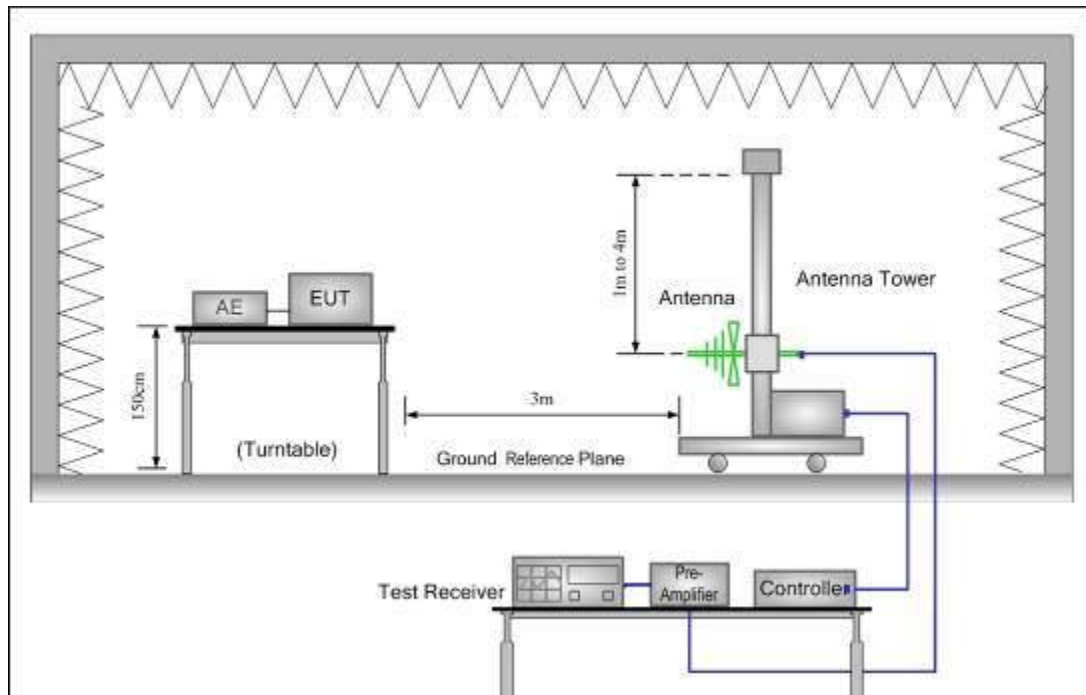

Figure 1. 30MHz to 1GHz

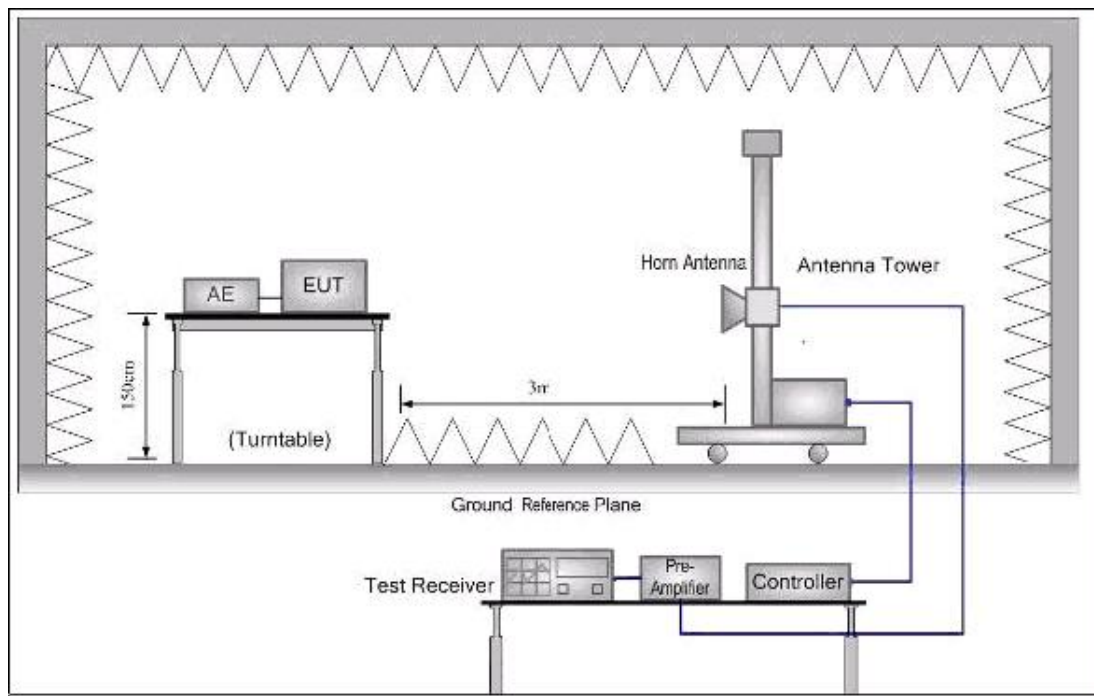

Figure 2. Above 1GHz

#### **5.12.4 Radiated Test result**

Note: For test data, please refer to the appendix results.

## 5.13 Receiver spurious emissions

### 5.13.1 Limit(ETSI EN 300 328 V2.2.2 (2019-07) Clause 4.3.1.11.3)

The spurious emissions of the receiver shall not exceed the values given in table 2.

**Spurious emission limits for receivers**

Frequency range	Maximum power, e.r.p. ( $\leq 1$ GHz) e.i.r.p. ( $> 1$ GHz)	Bandwidth
30 MHz to 1 GHz	-57 dBm	100KHz
1 GHz to 12,75 GHz	-47 dBm	1MHz

### 5.13.2 Test procedure

Refer to ETSI EN 300 328 V2.2.2 (2019-07) Clause 5.4.10

**EUT Operation:**

**Status:**

Enter test mode for the product, Test in Channel lowest (2402MHz) and highest (2480MHz), keep in continuously receiving status.

Pre-test the EUT in AC mode and B/O mode, find worse case in B/O mode.

### 5.13.3 Test Setup

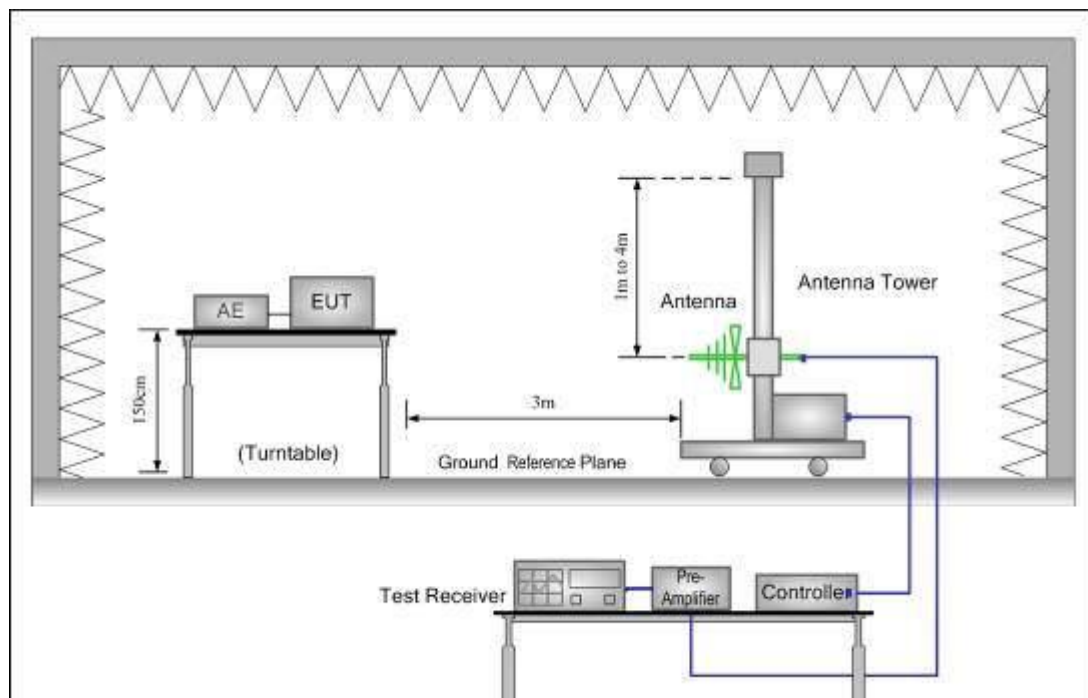

Figure 1. 30MHz to 1GHz

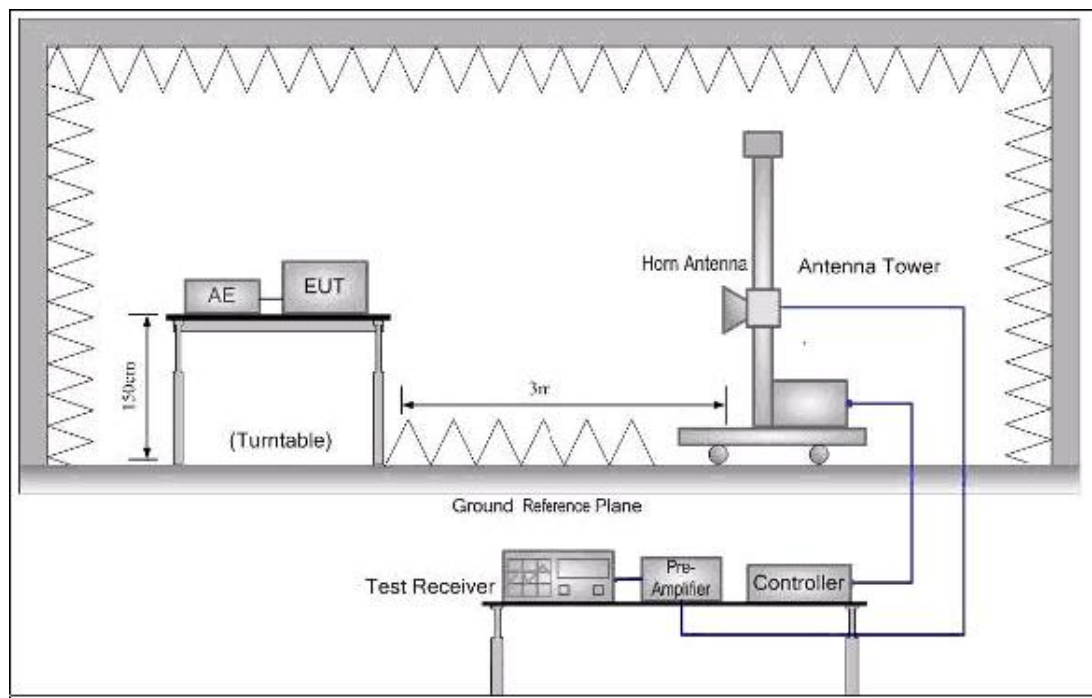

Figure 2. Above 1GHz

**Test procedure:**

Substitution method was performed to determine the actual spurious emission levels of the EUT.

The following test procedure as below:

1)Below 1GHz test procedure:

1. On the test site as test setup graph above, the EUT shall be placed at the 1.5m support on the turntable and in the position closest to normal use as declared by the provider.
2. The test antenna shall be oriented initially for vertical polarization and shall be chosen to correspond to the test frequency of the transmitter. The output of the test antenna shall be connected to the measuring receiver.
3. The transmitter shall be switched on, if possible, without modulation and the measuring receiver shall be tuned to the test frequency of the transmitter under test.
4. The test antenna shall be raised and lowered from 1m to 4m until a maximum signal level is detected by the measuring receiver. Then the turntable should be rotated through 360° in the horizontal plane, until the maximum signal level is detected by the measuring receiver.
5. Repeat step 4 for test frequency with the test antenna polarized horizontally.

6. Remove the transmitter and replace it with a substitution antenna (the antenna should be half-wavelength for each frequency involved). The center of the substitution antenna should be approximately at the same location as the center of the transmitter. At the lower frequencies, where the substitution antenna is very long, this will be impossible to achieve when the antenna is polarized vertically. In such case the lower end of the antenna should be 0.3 m above the ground.
7. Feed the substitution antenna at the transmitter end with a signal generator connected to the antenna by means of a nonradiating cable. With the antennas at both ends vertically polarized, and with the signal generator tuned to a particular test frequency, raise and lower the test antenna to obtain a maximum reading at the spectrum analyzer. Adjust the level of the signal generator output until the previously recorded maximum reading for this set of conditions is obtained. This should be done carefully repeating the adjustment of the test antenna and generator output.
8. Repeat step 7 with both antennas horizontally polarized for each test frequency.
9. Calculate power in dBm into a reference ideal half-wave dipole antenna by reducing the readings obtained in steps 7 and 8 by the power loss in the cable between the generator and the antenna, and further corrected for the gain of the substitution antenna used relative to an ideal half-wave dipole antenna by the following formula:

$$\text{ERP(dBm)} = \text{Pg(dBm)} - \text{cable loss (dB)} + \text{antenna gain (dBd)}$$

where:

Pg is the generator output power into the substitution antenna.

2) above 1GHz test procedure:

1. Different between above is the test site, change from Semi- Anechoic Chamber to fully Anechoic Chamber, and the test antenna do not need to raise from 1 to 4m, just test in 1.5m height.

#### 5.13.4 Test result

Note: For test data, please refer to the appendix results.

## 5.14.Receiver Blocking

### 5.14.1Performance Criteria

The minimum performance criterion shall be a PER less than or equal to 10 %. The manufacturer may declare alternative performance criteria as long as that is appropriate for the intended use of the equipment (see clause 5.4.1.t)).

### 5.14.2 Limit(ETSI EN 300 328 V2.2.2 (2019-07) Clause 4.3.2.11.4)

While maintaining the minimum performance criteria as defined in clause 4.3.1.12.3, the blocking levels at specified frequency offsets shall be equal to or greater than the limits defined for the applicable receiver category provided in table 6, table 7 or table 8.

#### Receiver Category 1

Table 6: Receiver Blocking parameters for Receiver Category 1 equipment

Wanted signal mean power from companion device (dBm) (see notes 1 and 4)	Blocking signal frequency (MHz)	Blocking signal power (dBm) (see note 4)	Type of blocking signal
$(-133 \text{ dBm} + 10 \times \log_{10}(\text{OCBW}))$ or $-68 \text{ dBm}$ whichever is less (see note 2)	2 380 2 504	-34	CW
$(-139 \text{ dBm} + 10 \times \log_{10}(\text{OCBW}))$ or $-74 \text{ dBm}$ whichever is less (see note 3)	2 300 2 330 2 360 2 524 2 584 2 674		

NOTE 1: OCBW is in Hz.

NOTE 2: In case of radiated measurements using a companion device and the level of the wanted signal from the companion device cannot be determined, a relative test may be performed using a wanted signal up to  $P_{\text{min}} + 26 \text{ dB}$  where  $P_{\text{min}}$  is the minimum level of wanted signal required to meet the minimum performance criteria as defined in clause 4.3.1.12.3 in the absence of any blocking signal.

NOTE 3: In case of radiated measurements using a companion device and the level of the wanted signal from the companion device cannot be determined, a relative test may be performed using a wanted signal up to  $P_{\text{min}} + 20 \text{ dB}$  where  $P_{\text{min}}$  is the minimum level of wanted signal required to meet the minimum performance criteria as defined in clause 4.3.1.12.3 in the absence of any blocking signal.

NOTE 4: The level specified is the level at the UUT receiver input assuming a 0 dBi antenna assembly gain. In case of conducted measurements, this level has to be corrected for the (in-band) antenna assembly gain (G). In case of radiated measurements, this level is equivalent to a power flux density (PFD) in front of the UUT antenna with the UUT being configured/positioned as recorded in clause 5.4.3.2.2.

**Receiver Category 2**

Table 7: Receiver Blocking parameters receiver Category 2 equipment

Wanted signal mean power from companion device (dBm) (see notes 1 and 3)	Blocking signal frequency (MHz)	Blocking signal power (dBm) (see note 3)	Type of blocking signal
(-139 dBm + 10 × log10(OCBW) + 10 dB) or (-74 dBm + 10 dB) whichever is less (see note 2)	2 380	-34	CW
	2 504		
	2 300		
	2 584		
<p>NOTE 1: OCBW is in Hz.</p> <p>NOTE 2: In case of radiated measurements using a companion device and the level of the wanted signal from the companion device cannot be determined, a relative test may be performed using a wanted signal up to Pmin + 26 dB where Pmin is the minimum level of wanted signal required to meet the minimum performance criteria as defined in clause 4.3.1.12.3 in the absence of any blocking signal.</p> <p>NOTE 3: The level specified is the level at the UUT receiver input assuming a 0 dBi antenna assembly gain. In case of conducted measurements, this level has to be corrected for the (in-band) antenna assembly gain (G). In case of radiated measurements, this level is equivalent to a power flux density (PFD) in front of the UUT antenna with the UUT being configured/positioned as recorded in clause 5.4.3.2.2.</p>			

**Receiver Category 3**

Table 8: Receiver Blocking parameters receiver Category 3 equipment

Wanted signal mean power from companion device (dBm) (see notes 1 and 3)	Blocking signal frequency (MHz)	Blocking signal power (dBm) (see note 3)	Type of blocking Signal
(-139 dBm + 10 × log10(OCBW) + 20 dB) or (-74 dBm + 20 dB) whichever is less (see note 2)	2 380	-34	CW
	2 504		
	2 300		
	2 584		
<p>NOTE 1: OCBW is in Hz.</p> <p>NOTE 2: In case of radiated measurements using a companion device and the level of the wanted signal from the companion device cannot be determined, a relative the test may be performed using a wanted signal up to Pmin + 30 dB where Pmin is the minimum level of wanted signal required to meet the minimum performance criteria as defined in clause 4.3.1.12.3 in the absence of any blocking signal.</p> <p>NOTE 3: The level specified is the level at the UUT receiver input assuming a 0 dBi antenna assembly gain. In case of conducted measurements, this level has to be corrected for the (in-band) antenna assembly gain (G). In case of radiated measurements, this level is equivalent to a power flux density (PFD) in front of the UUT antenna with the UUT being configured/positioned as recorded in clause 5.4.3.2.2.</p>			

**5.14.3 Test procedure**

Refer to ETSI EN 300 328 V2.2.2 (2019-07) Clause 5.4.11.2

Measurement	
<input checked="" type="checkbox"/> Conducted measurement	<input type="checkbox"/> Radiated measurement



### 5.14.4 Test Setup

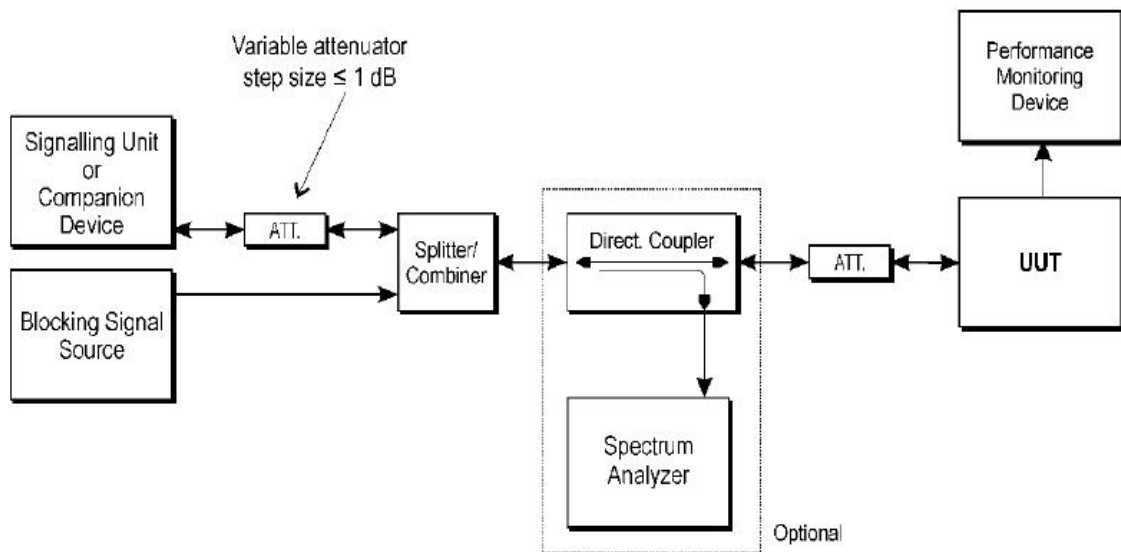

### 5.14.5 Test result

Note: For test data, please refer to the appendix results.

## 6 .Appendix test data

### Appendix A. RF Output Power (E.I.R.P.)

Measurement Data:

Test Data of RF Output Power					
Test Mode	RF Output Power E.I.R.P.[dBm]			Limit [dBm]	Verdict
	NT	LT	HT		
BR_HOP_NA_1Mbps	2.97	1.72	1.76	20	Pass
EDR_HOP_NA_2Mbps	3.06	1.85	1.86	20	Pass
EDR_HOP_NA_3Mbps	<b>3.17</b>	1.97	1.96	20	Pass

Note: Only the data of worst case is reported as above.

## **Appendix B. Duty cycle, Tx-Sequence, Tx-gap**

Measurement Data:

No applicable.

Refer to the EN 300 328 clause 4.3.1.3.1 section for the details.

These requirements apply to non-adaptive frequency hopping equipment or to adaptive frequency hopping equipment operating in a non-adaptive mode.

These requirements do not apply for equipment with a maximum declared RF Output power of less than 10 dBm e.i.r.p. or for equipment when operating in a mode where the RF Output power is less than 10 dBm e.i.r.p.

As the EUT belongs to Adaptive equipment type, so the test is not applicable and skipped.

### Appendix C. Dwell time, Minimum Frequency Occupation and Hopping Sequence

Measurement Data:

Dwell Time:

GFSK. Channel 00: 2.402GHz										
DH5 time slot	=	2.91	(ms)	*	11	*	(31.6/3.16)	=	320.10	ms
8DPSK. Channel 00: 2.402GHz										
3DH5 time slot	=	2.897	(ms)	*	8	*	(31.6/3.16)	=	231.76	ms

Note:

1.Dwell time =  $(1600/(79 \cdot DHT)) \cdot 79 \cdot 0.4 \cdot \text{Single hop time}$ , where DHT=2/4/6 for DH1/DH3/DH5.

The results are not greater than 0.4 seconds.

2.All the modes had been tested, but only the worst data recorded in the report.

Test graph as below:

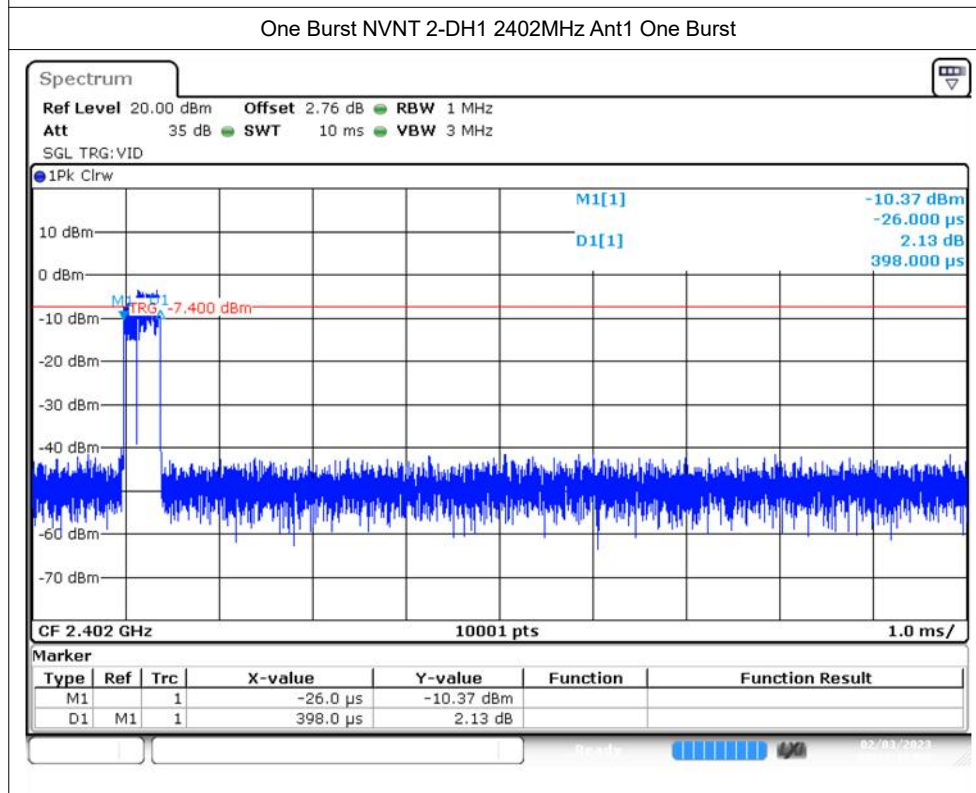
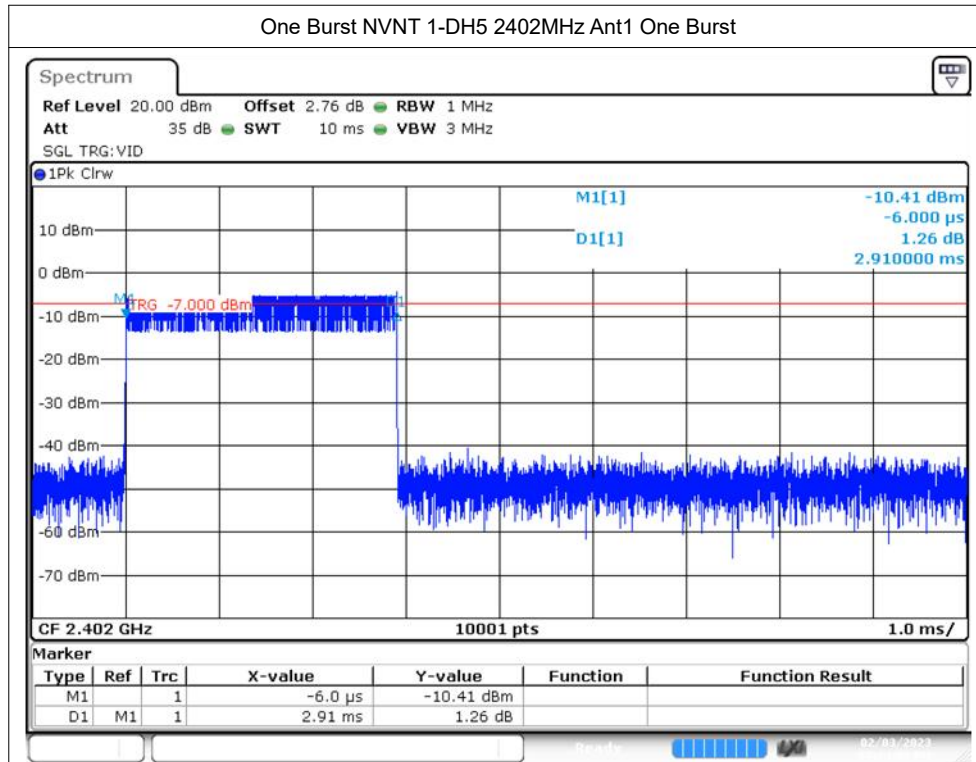

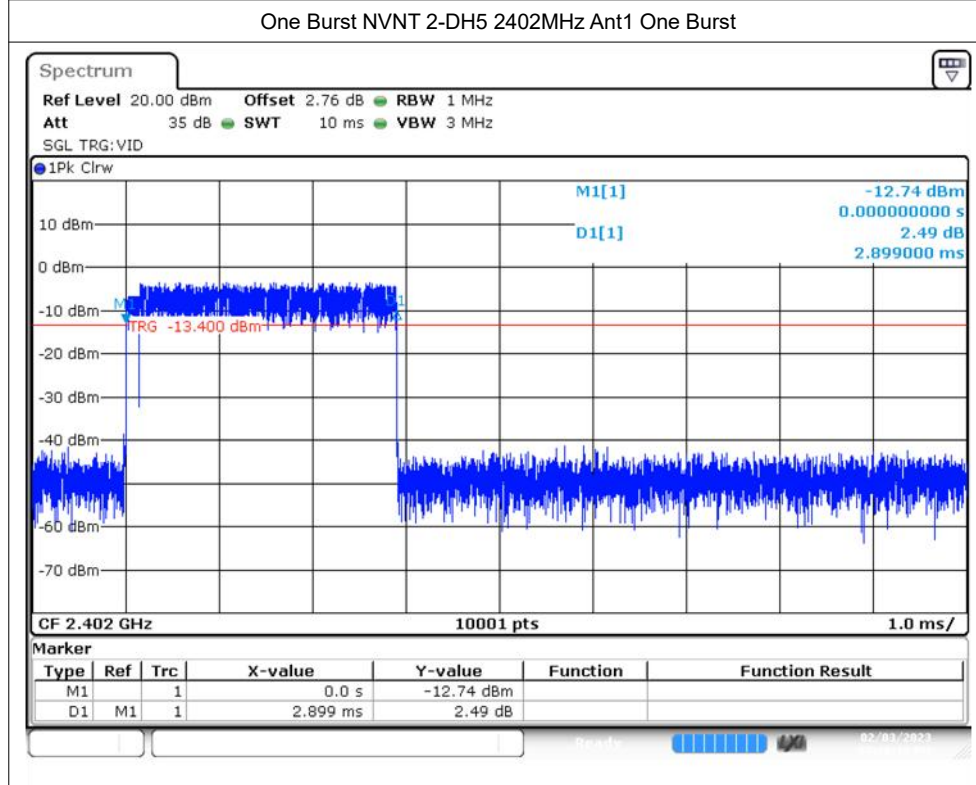
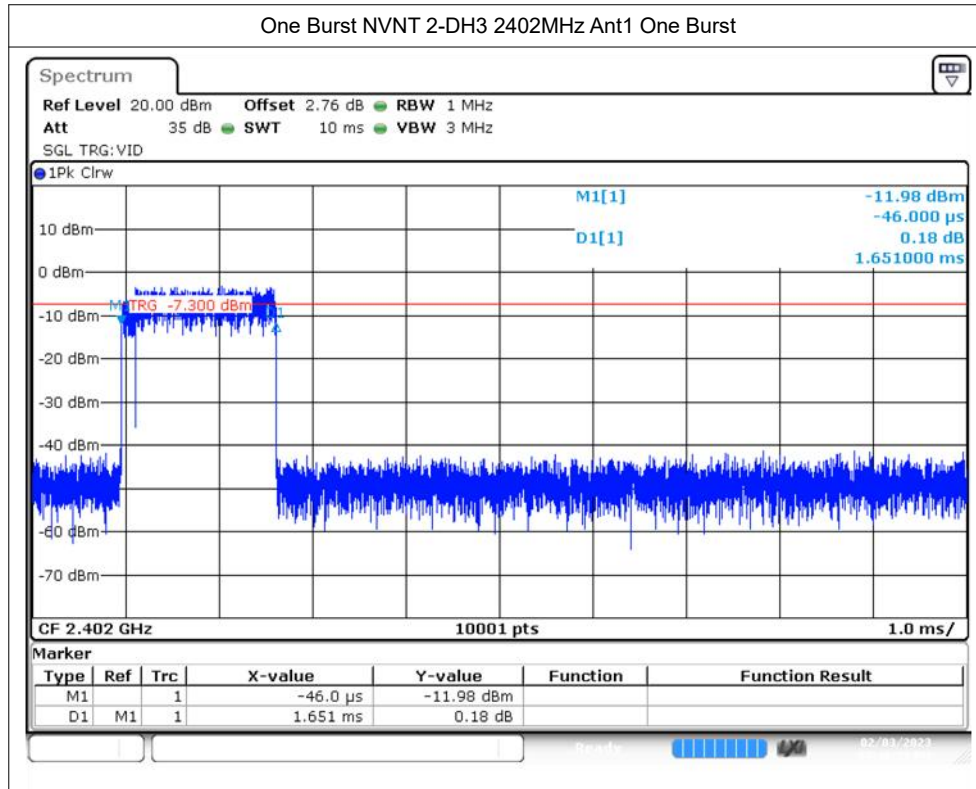

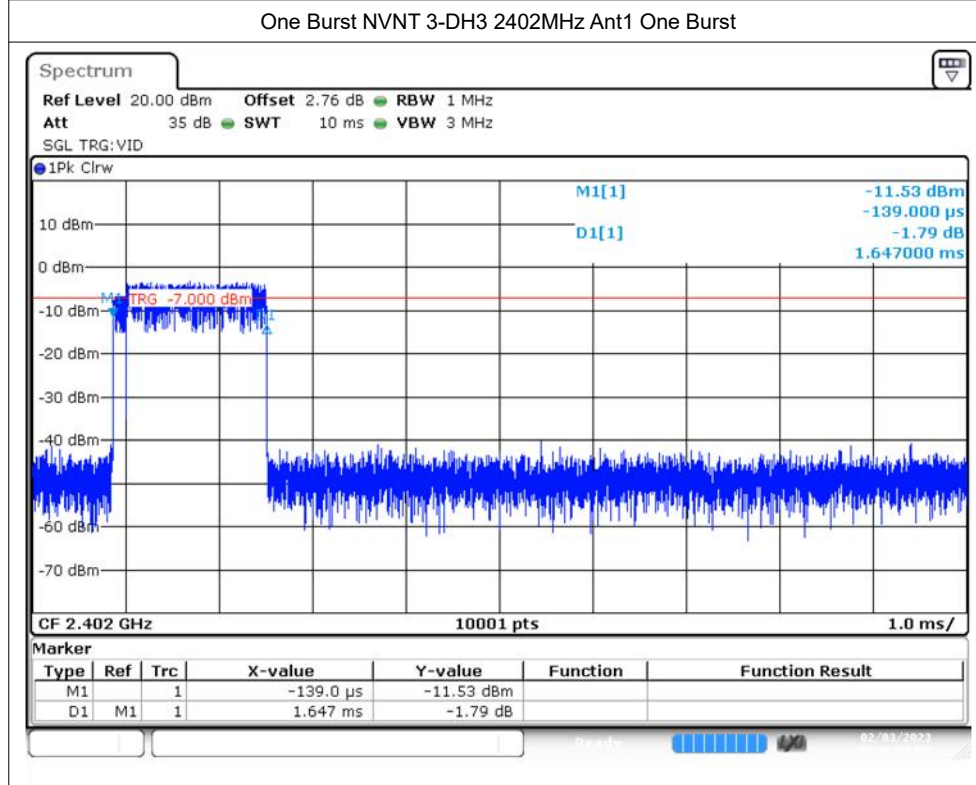
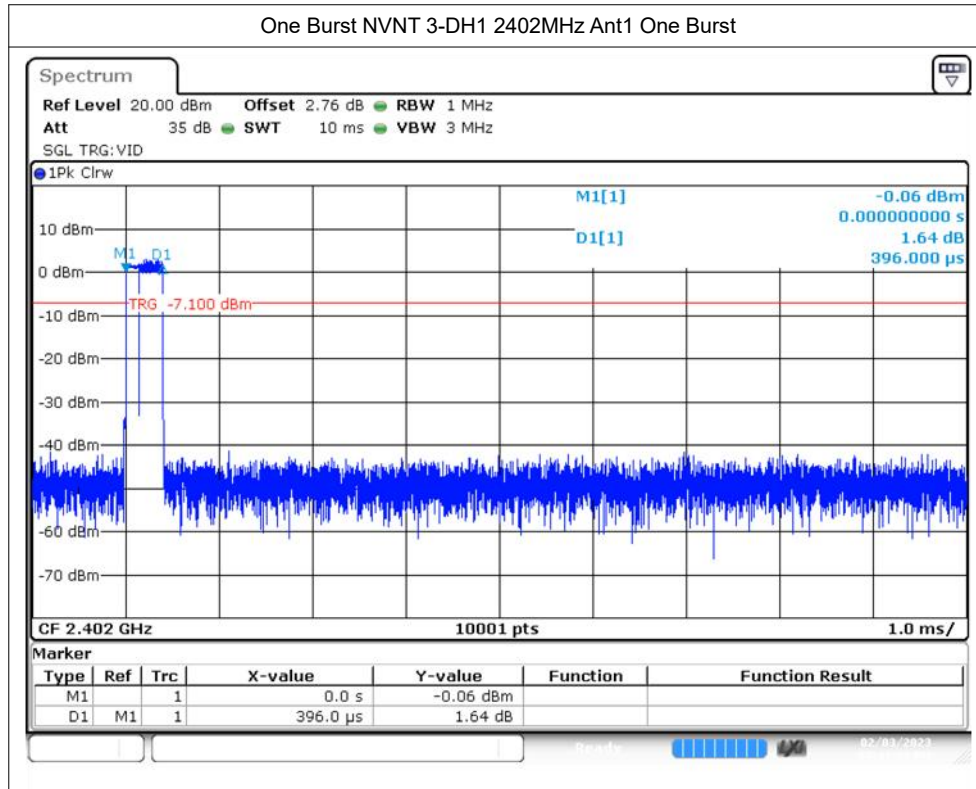

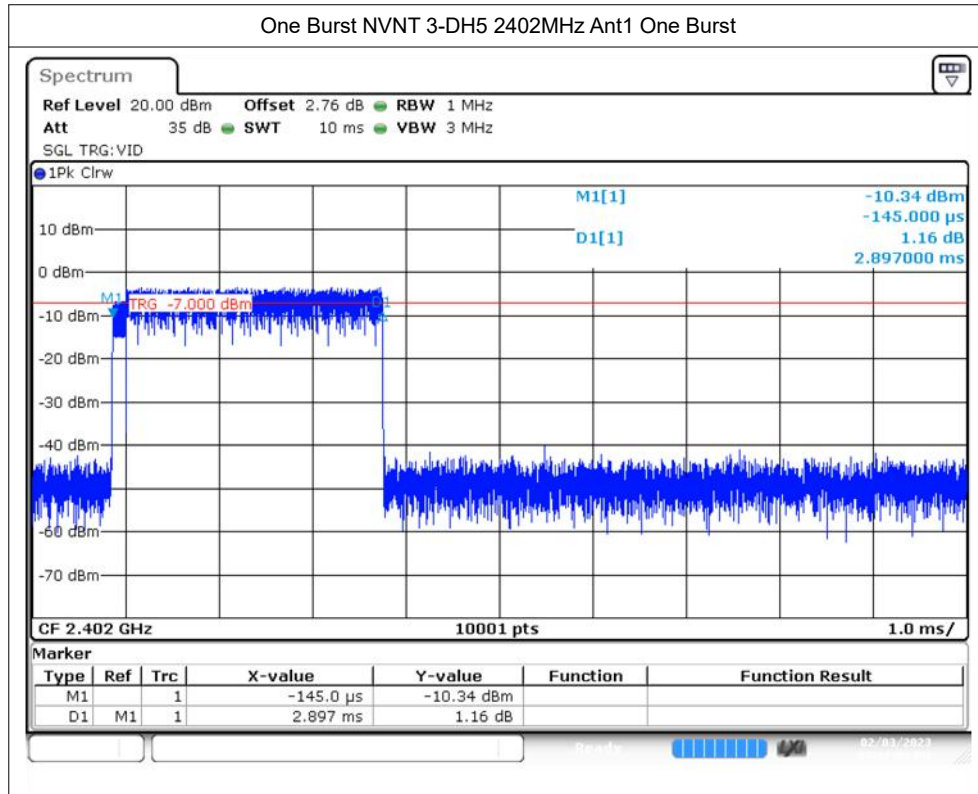



## Appendix D. Frequency Occupation

Measurement Data:

Channel (MHz)	Packages	Dwell Time per hop (ms)	Testing period (ms)	Frequency Occupation period	Limit Dwell Times No.	Result
2402	1DH5	2.91	919.56	2	one dwell time	Pass

Channel (MHz)	Packages	Dwell Time per hop (ms)	Testing period (ms)	Frequency Occupation period	Limit Dwell Times No.	Result
2402	3DH5	2.879	915.452	2	one dwell time	Pass

**Note:**

1. Testing period: 4 x Dwell time per hop x 79 Channels
2. All the modes had been tested, but only the worst data recorded in the report.

### Appendix E. Hopping Sequence

Measurement Data:

The unit does meet the requirements.

Hopping Sequence					
Test Mode	Operation band (MHz)	20dB Down Bandwidth (%)	Limit (%)	Channel number	Limit (N)
BR_HOP_NA_3Mbps	2402-2480	96.0	≥70%	79	≥15

Test graph as below:

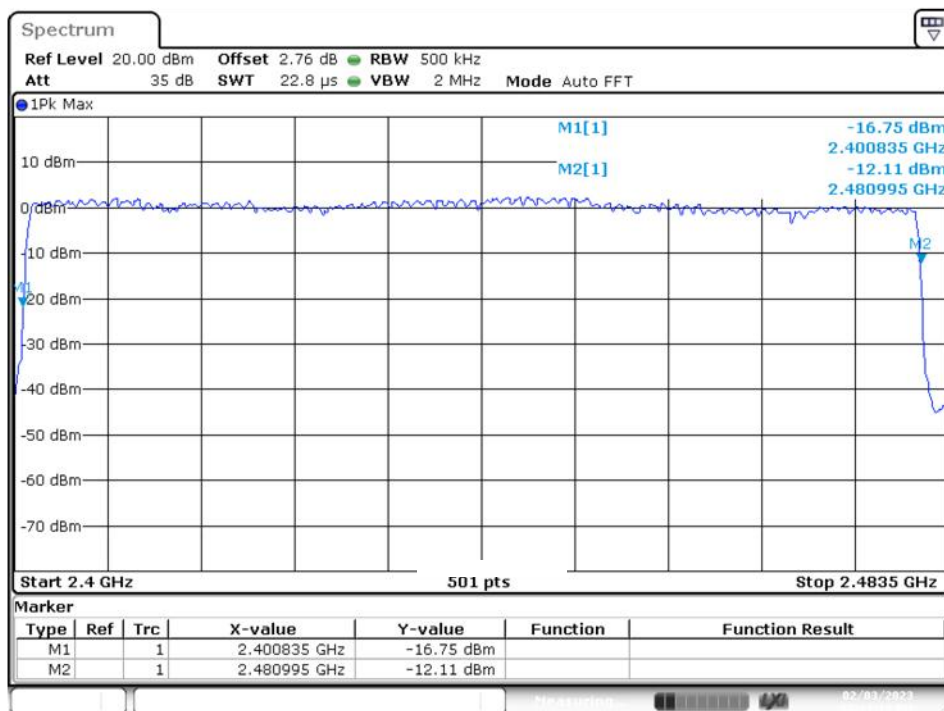

**Note:** The modulation used during test is 8DPSK and this is the worst case.

## Appendix F. Hopping Frequency Separation

Measurement Data:

Test Data of Hopping Frequency Separation			
Test Mode	Hopping Frequency Separation [MHz]	Limit [MHz]	Verdict
BR_HOP_NA_1Mbps	1.021	≥0.1	Pass

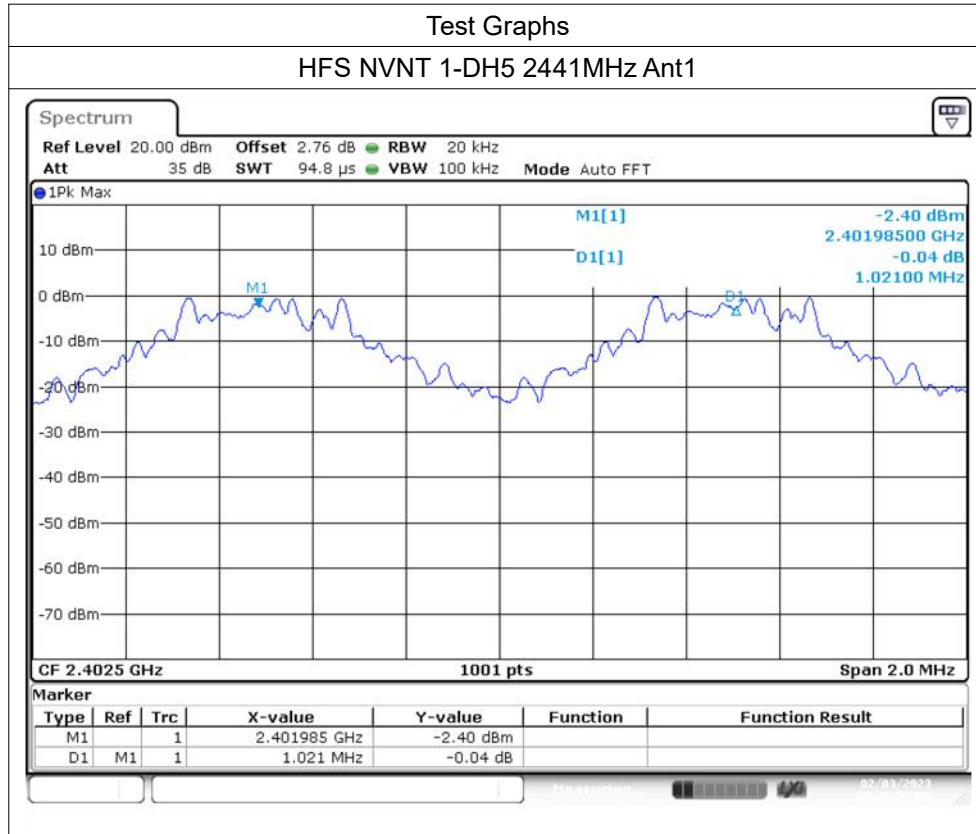

**Note:** The modulation used during test is GFSK and this is the worst case.

### Appendix G. Adaptivity (Adaptive Frequency Hopping)

Measurement Data:

Not Applicable

### Appendix H. Occupied Channel Bandwidth

Measurement Data:

Test Data of Occupied Channel Bandwidth					
Test Mode	Occupied Channel Bandwidth [MHz]			Limit [MHz]	Verdict
	OCB	FL	FH		
BR_2402_1Mbps	0.859	2401.565	2402.424	2400 to 2483.5	Pass
BR_2480_1Mbps	0.863	2479.56	2480.423	2400 to 2483.5	Pass
EDR_2402_2Mbps	1.184	2401.404	2402.588	2400 to 2483.5	Pass
EDR_2480_2Mbps	1.183	2479.402	2480.585	2400 to 2483.5	Pass
EDR_2402_3Mbps	1.191	2401.397	2402.588	2400 to 2483.5	Pass
EDR_2480_3Mbps	1.192	2479.394	2480.586	2400 to 2483.5	Pass

Test Graphs of Occupied Channel Bandwidth

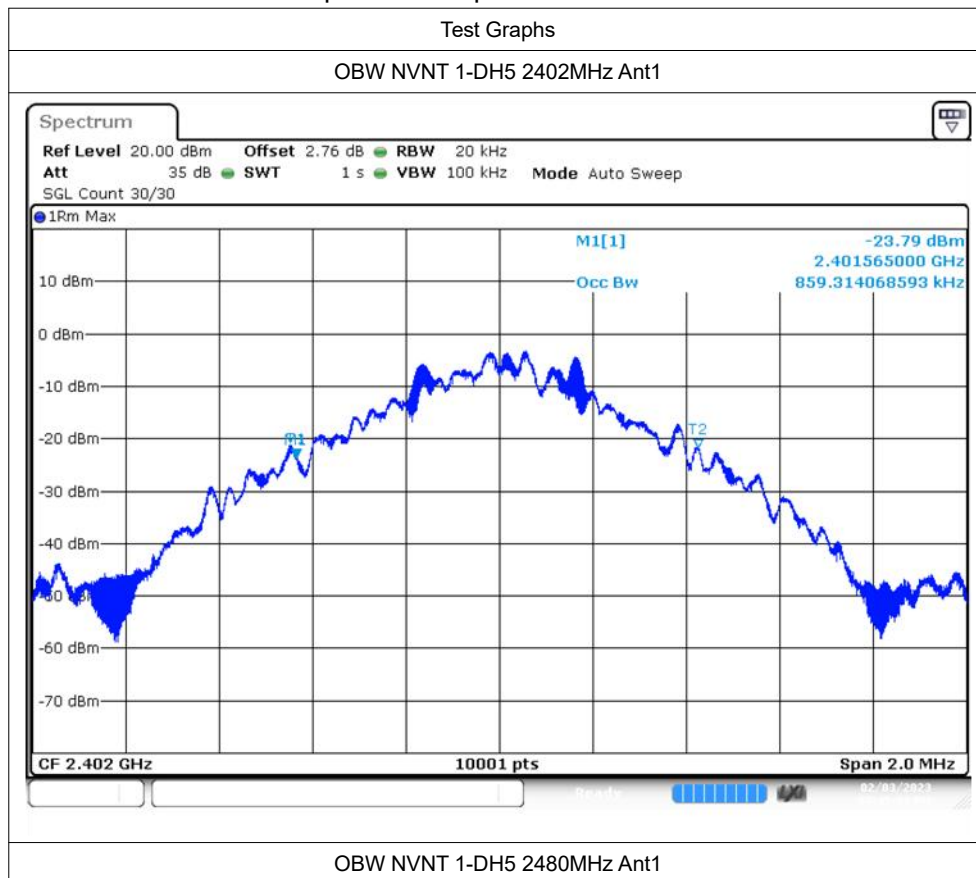

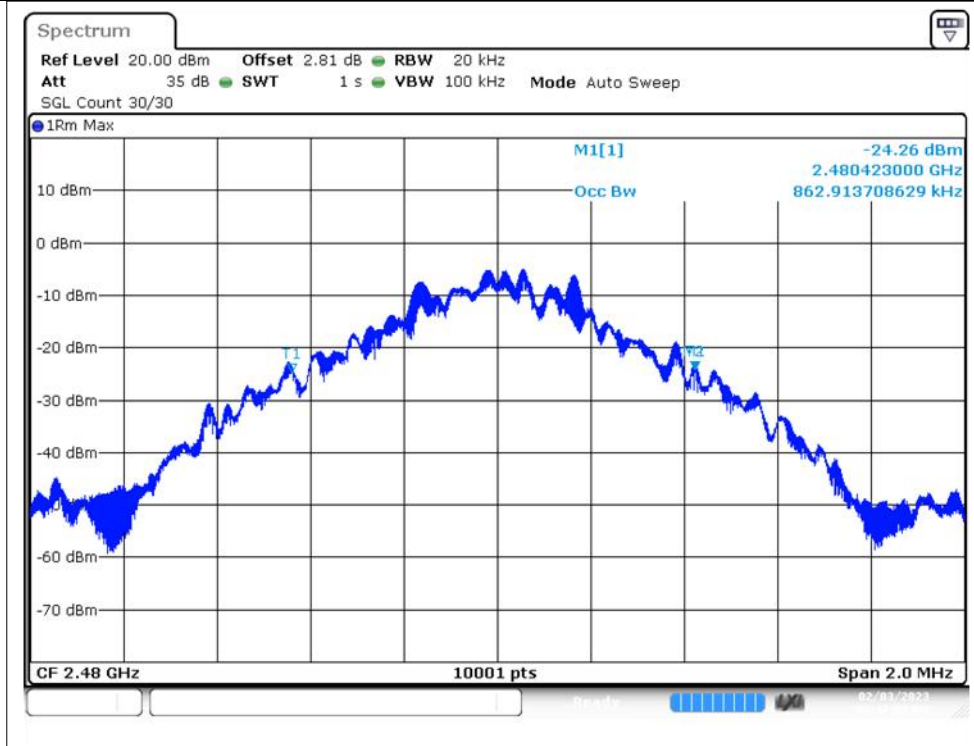

OBW NVNT 2-DH5 2402MHz Ant1

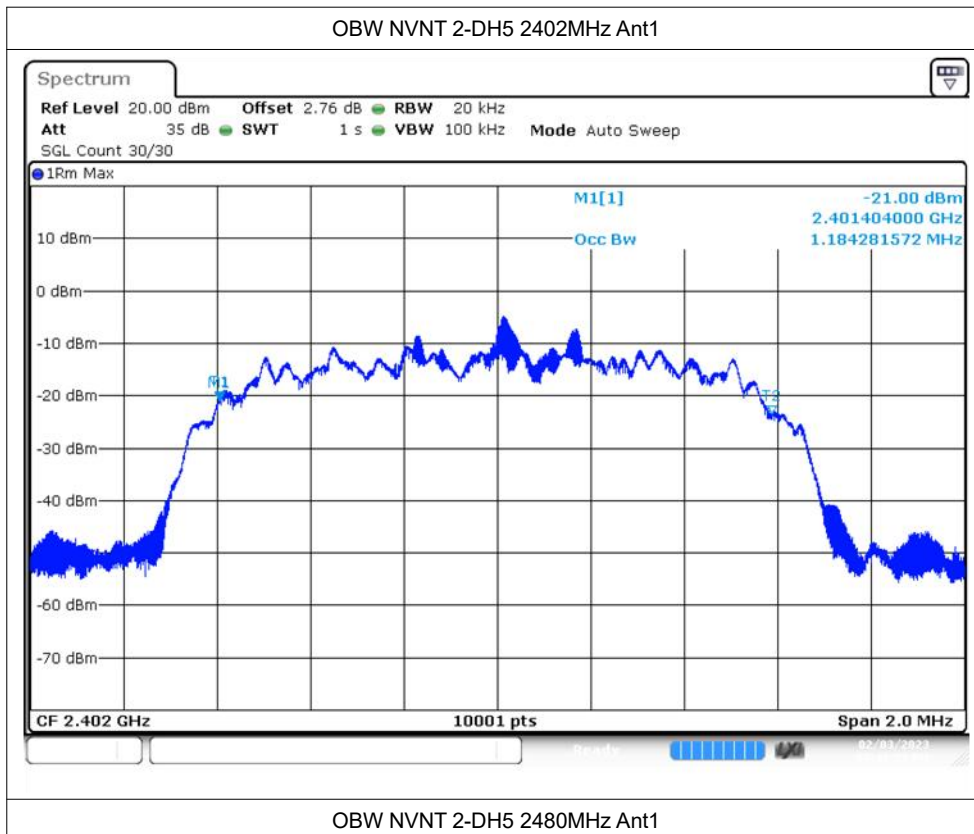

OBW NVNT 2-DH5 2480MHz Ant1

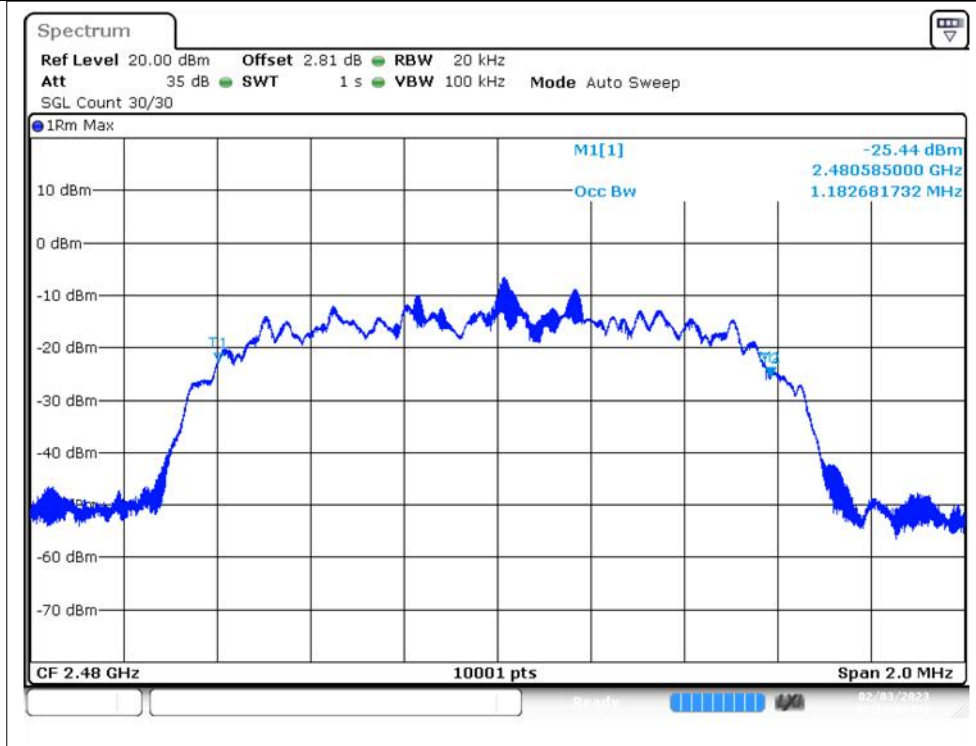

OBW NVNT 3-DH5 2402MHz Ant1

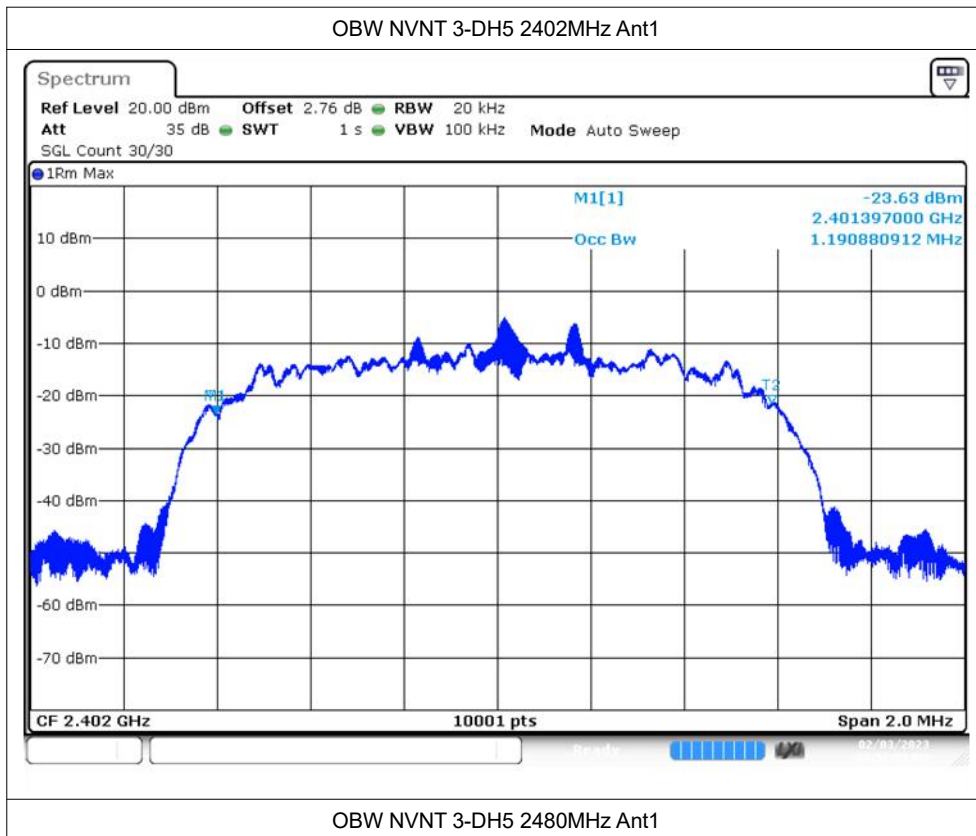

OBW NVNT 3-DH5 2480MHz Ant1

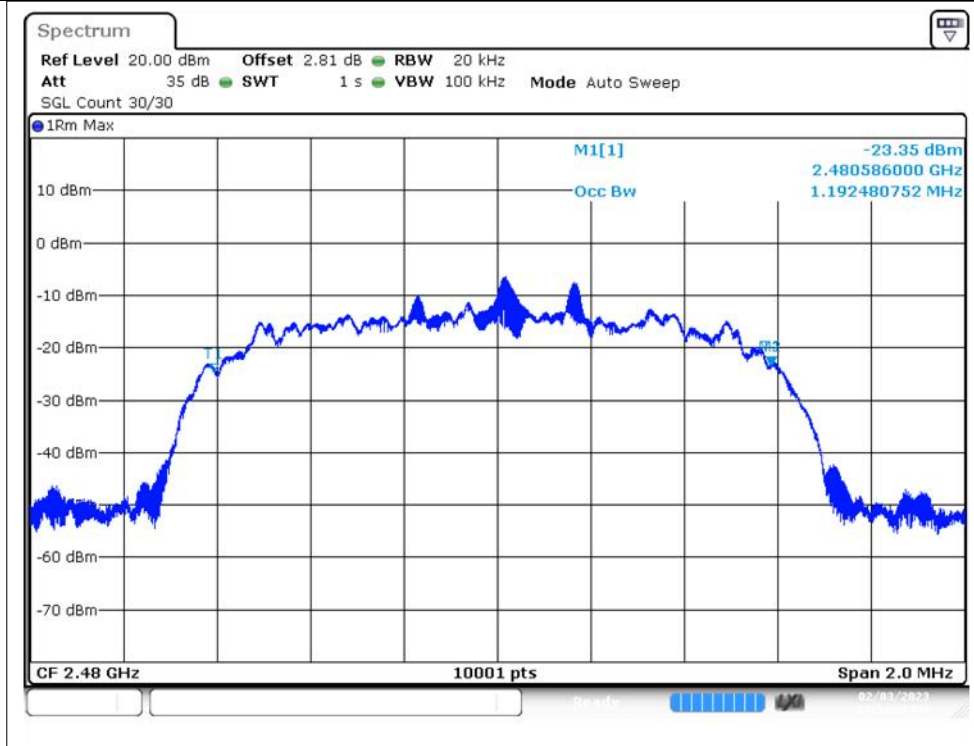

### Appendix I. Transmitter unwanted emissions in the out-of-band domain

Measurement Data:

Test Data of OOB Emissions				
Test Mode	Frequency [MHz]	Level [dBm]	Limit [dBm]	Verdict
BR_HOP_NA_1Mbps	2399.500	-43.07	-10	Pass
	2398.500	-42.64	-20	Pass
	2484.000	-42.19	-10	Pass
	2485.000	-42.22	-20	Pass

Test Graphs of OOB Emissions

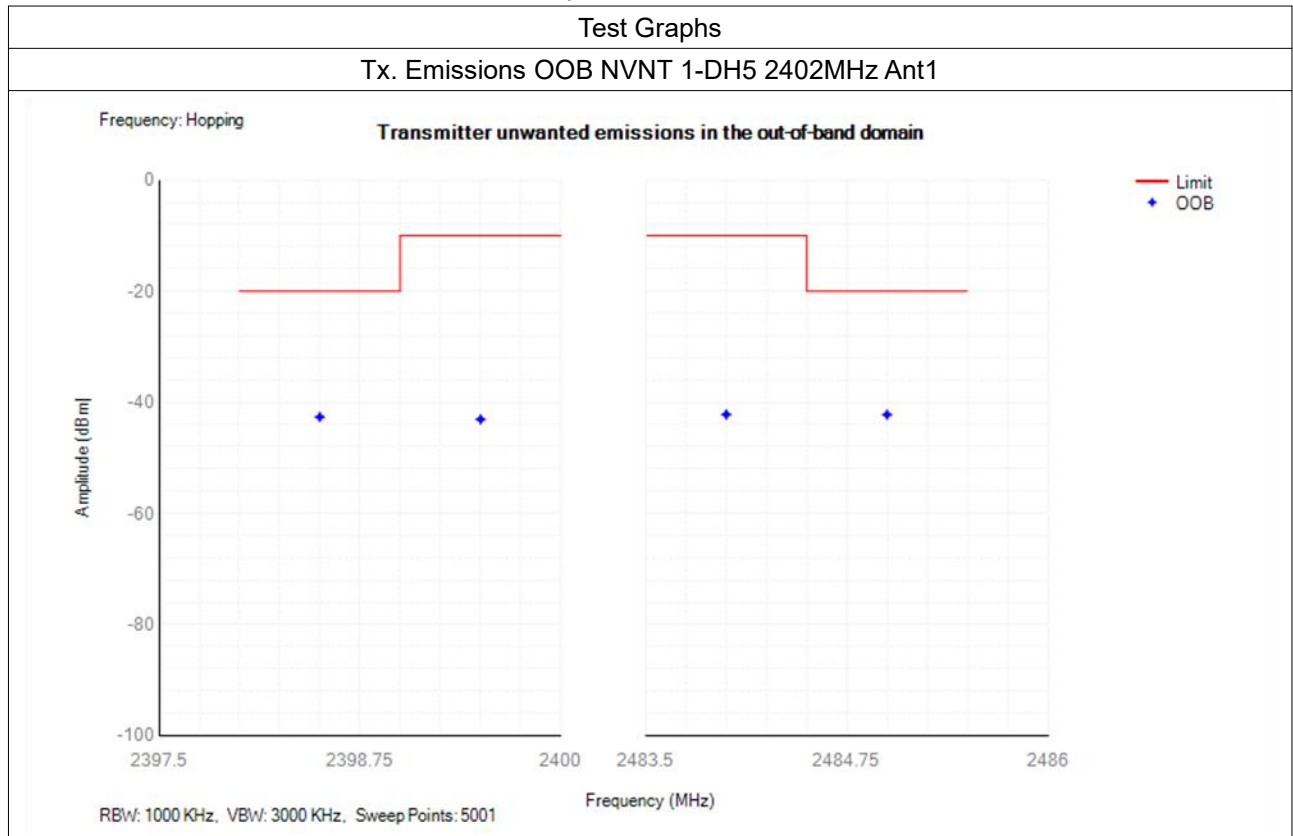

**Note:** All the modes had been tested, but only the worst data recorded in the report.



### Appendix J. Transmitter unwanted emissions in the spurious domain

Measurement Data:

Test Data of Transmitter Spurious Emissions (Conducted Method)								
Mode	Frequency (MHz)	Antenna	Range (MHz)	Spur Freq (MHz)	Peak (dBm)	RMS (dBm)	Limit (dBm)	Verdict
1-DH5	2402	Ant1	30 -47	39.90	-79.37	NA	-36	Pass
1-DH5	2402	Ant1	47 -74	59.05	-78.78	NA	-54	Pass
1-DH5	2402	Ant1	74 -87.5	85.20	-78.92	NA	-36	Pass
1-DH5	2402	Ant1	87.5 -118	93.90	-79.08	NA	-54	Pass
1-DH5	2402	Ant1	118 -174	166.90	-78.18	NA	-36	Pass
1-DH5	2402	Ant1	174 -230	209.70	-78.07	NA	-54	Pass
1-DH5	2402	Ant1	230 -470	249.75	-77.94	NA	-36	Pass
1-DH5	2402	Ant1	470 -694	598.00	-76.34	NA	-54	Pass
1-DH5	2402	Ant1	694 -1000	953.20	-72.09	NA	-36	Pass
1-DH5	2402	Ant1	1000 -2398	2397.00	-44.60	NA	-30	Pass
1-DH5	2402	Ant1	2485.5 -12750	10563.00	-46.40	NA	-30	Pass
1-DH5	2480	Ant1	30 -47	41.80	-79.29	NA	-36	Pass
1-DH5	2480	Ant1	47 -74	49.35	-78.91	NA	-54	Pass
1-DH5	2480	Ant1	74 -87.5	86.05	-79.01	NA	-36	Pass
1-DH5	2480	Ant1	87.5 -118	107.95	-78.95	NA	-54	Pass
1-DH5	2480	Ant1	118 -174	135.20	-78.02	NA	-36	Pass
1-DH5	2480	Ant1	174 -230	204.15	-78.26	NA	-54	Pass
1-DH5	2480	Ant1	230 -470	254.00	-78.03	NA	-36	Pass
1-DH5	2480	Ant1	470 -694	589.70	-77.49	NA	-54	Pass
1-DH5	2480	Ant1	694 -1000	951.35	-72.95	NA	-36	Pass
1-DH5	2480	Ant1	1000 -2398	1791.00	-55.46	NA	-30	Pass
1-DH5	2480	Ant1	2485.5 -12750	10558.50	-46.39	NA	-30	Pass
2-DH5	2402	Ant1	30 -47	46.60	-79.30	NA	-36	Pass
2-DH5	2402	Ant1	47 -74	72.20	-79.74	NA	-54	Pass
2-DH5	2402	Ant1	74 -87.5	77.15	-78.66	NA	-36	Pass
2-DH5	2402	Ant1	87.5 -118	102.85	-79.28	NA	-54	Pass
2-DH5	2402	Ant1	118 -174	170.20	-78.48	NA	-36	Pass
2-DH5	2402	Ant1	174 -230	200.70	-78.27	NA	-54	Pass
2-DH5	2402	Ant1	230 -470	349.05	-77.70	NA	-36	Pass
2-DH5	2402	Ant1	470 -694	583.05	-77.90	NA	-54	Pass
2-DH5	2402	Ant1	694 -1000	951.85	-72.56	NA	-36	Pass
2-DH5	2402	Ant1	1000 -2398	2397.00	-45.64	NA	-30	Pass
2-DH5	2402	Ant1	2485.5	10597.00	-46.04	NA	-30	Pass



			-12750					
2-DH5	2480	Ant1	30 -47	44.80	-79.34	NA	-36	Pass
2-DH5	2480	Ant1	47 -74	71.10	-79.42	NA	-54	Pass
2-DH5	2480	Ant1	74 -87.5	80.60	-79.49	NA	-36	Pass
2-DH5	2480	Ant1	87.5 -118	103.55	-79.24	NA	-54	Pass
2-DH5	2480	Ant1	118 -174	153.90	-78.72	NA	-36	Pass
2-DH5	2480	Ant1	174 -230	205.45	-78.10	NA	-54	Pass
2-DH5	2480	Ant1	230 -470	382.40	-77.62	NA	-36	Pass
2-DH5	2480	Ant1	470 -694	581.60	-77.62	NA	-54	Pass
2-DH5	2480	Ant1	694 -1000	955.50	-73.38	NA	-36	Pass
2-DH5	2480	Ant1	1000 -2398	2064.00	-56.39	NA	-30	Pass
2-DH5	2480	Ant1	2485.5 -12750	12660.50	-46.02	NA	-30	Pass
3-DH5	2402	Ant1	30 -47	32.75	-79.23	NA	-36	Pass
3-DH5	2402	Ant1	47 -74	56.40	-78.07	NA	-54	Pass
3-DH5	2402	Ant1	74 -87.5	78.70	-79.57	NA	-36	Pass
3-DH5	2402	Ant1	87.5 -118	115.25	-79.12	NA	-54	Pass
3-DH5	2402	Ant1	118 -174	150.80	-79.04	NA	-36	Pass
3-DH5	2402	Ant1	174 -230	216.80	-77.63	NA	-54	Pass
3-DH5	2402	Ant1	230 -470	303.80	-77.52	NA	-36	Pass
3-DH5	2402	Ant1	470 -694	655.45	-77.20	NA	-54	Pass
3-DH5	2402	Ant1	694 -1000	955.25	-73.39	NA	-36	Pass
3-DH5	2402	Ant1	1000 -2398	2397.00	-45.38	NA	-30	Pass
3-DH5	2402	Ant1	2485.5 -12750	10299.50	-46.35	NA	-30	Pass
3-DH5	2480	Ant1	30 -47	41.50	-78.92	NA	-36	Pass
3-DH5	2480	Ant1	47 -74	68.50	-79.11	NA	-54	Pass
3-DH5	2480	Ant1	74 -87.5	78.80	-79.83	NA	-36	Pass
3-DH5	2480	Ant1	87.5 -118	106.20	-79.07	NA	-54	Pass
3-DH5	2480	Ant1	118 -174	157.55	-78.88	NA	-36	Pass
3-DH5	2480	Ant1	174 -230	228.65	-78.19	NA	-54	Pass
3-DH5	2480	Ant1	230 -470	357.40	-77.84	NA	-36	Pass
3-DH5	2480	Ant1	470 -694	663.50	-77.49	NA	-54	Pass
3-DH5	2480	Ant1	694 -1000	955.00	-72.73	NA	-36	Pass
3-DH5	2480	Ant1	1000 -2398	2133.00	-56.02	NA	-30	Pass
3-DH5	2480	Ant1	2485.5 -12750	12618.00	-46.81	NA	-30	Pass

### Test Graphs of Transmitter Spurious Emissions (Conducted Method)

Tx. Spurious NVNT 1-DH5 2402MHz Ant1

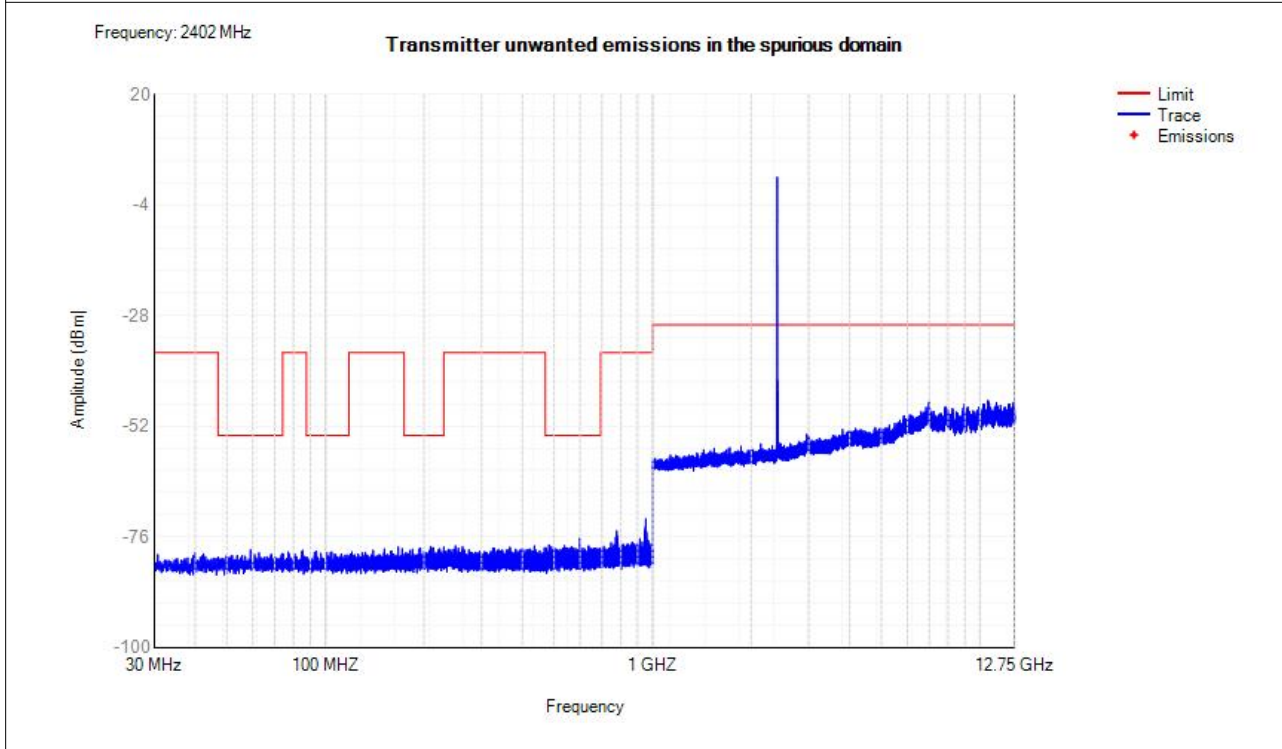

Tx. Spurious NVNT 1-DH5 2480MHz Ant1

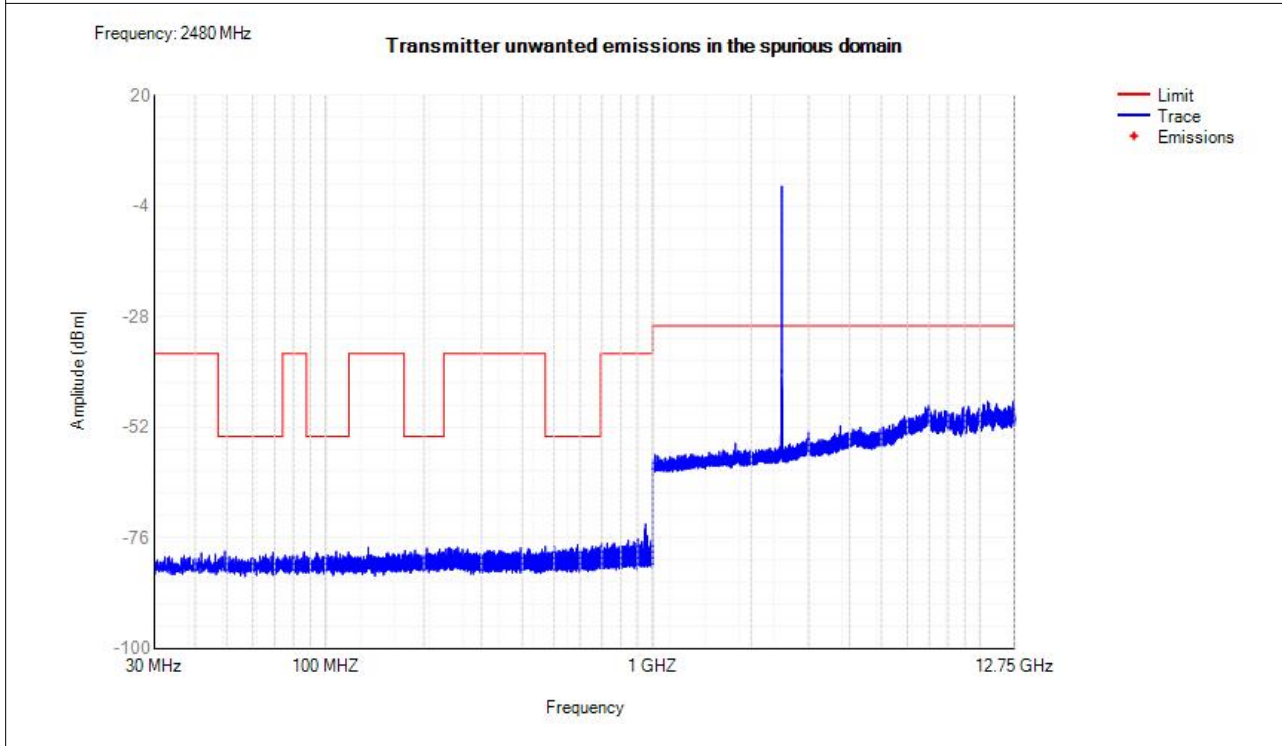

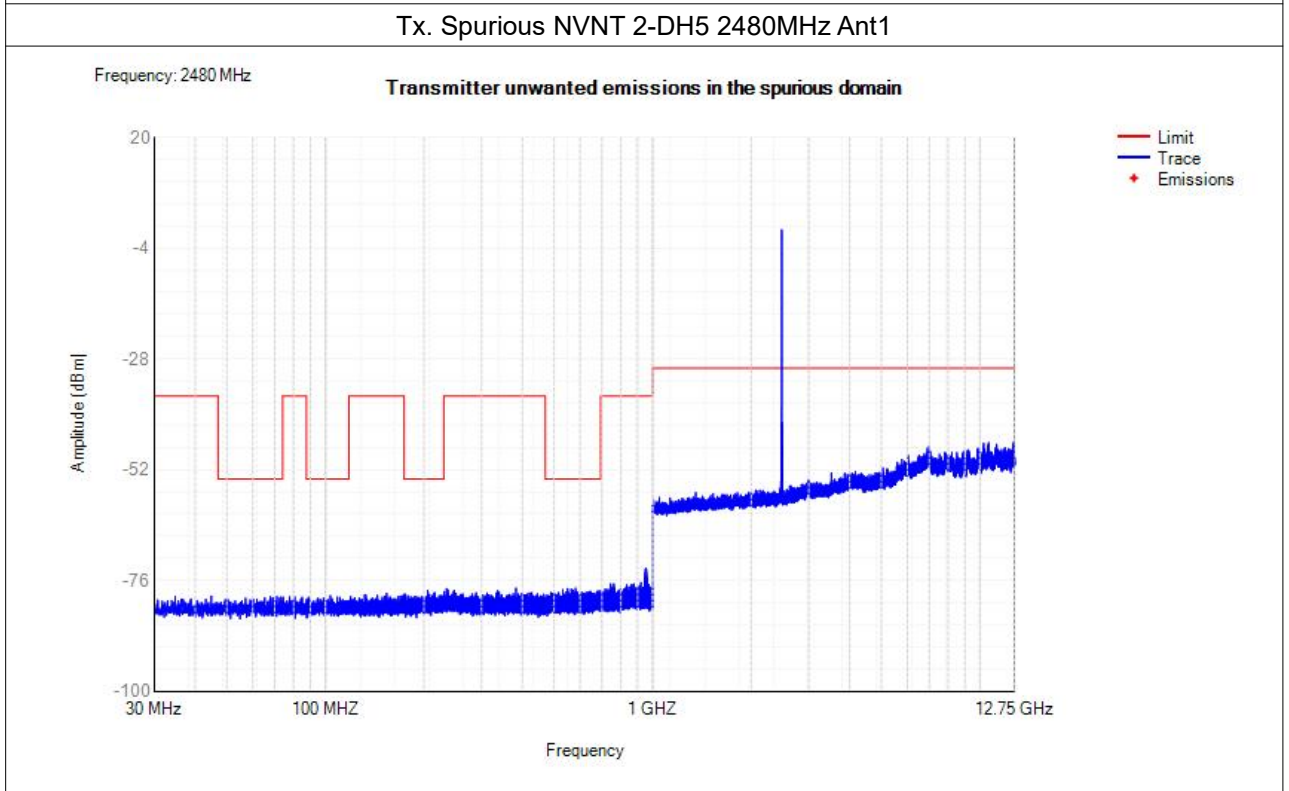
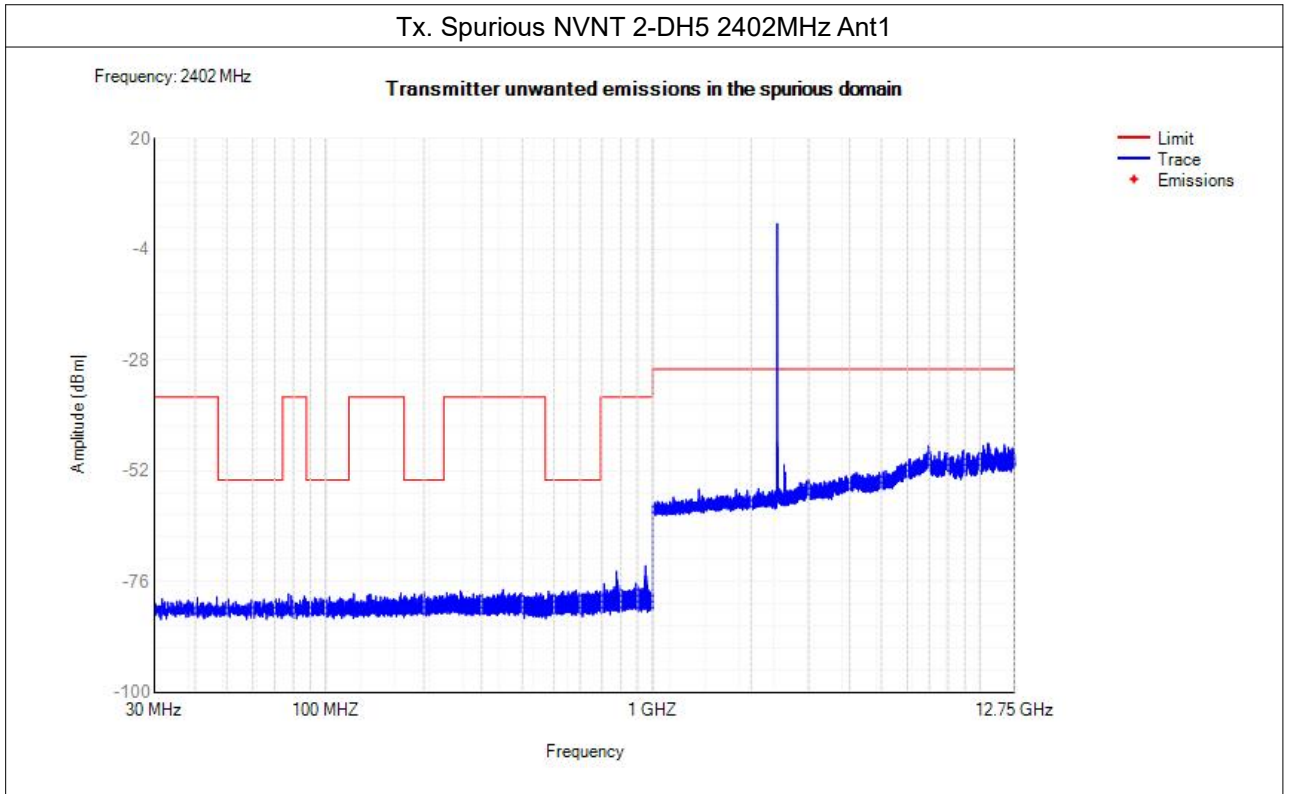

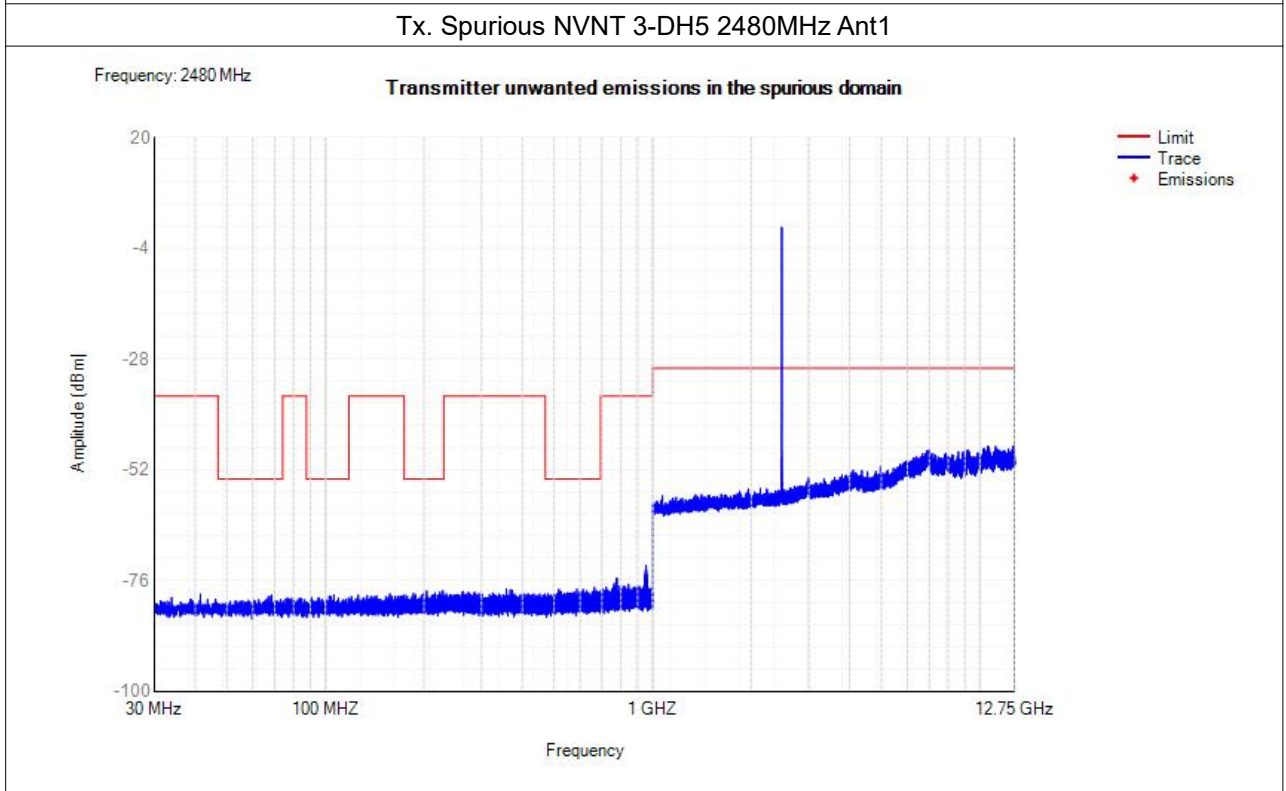
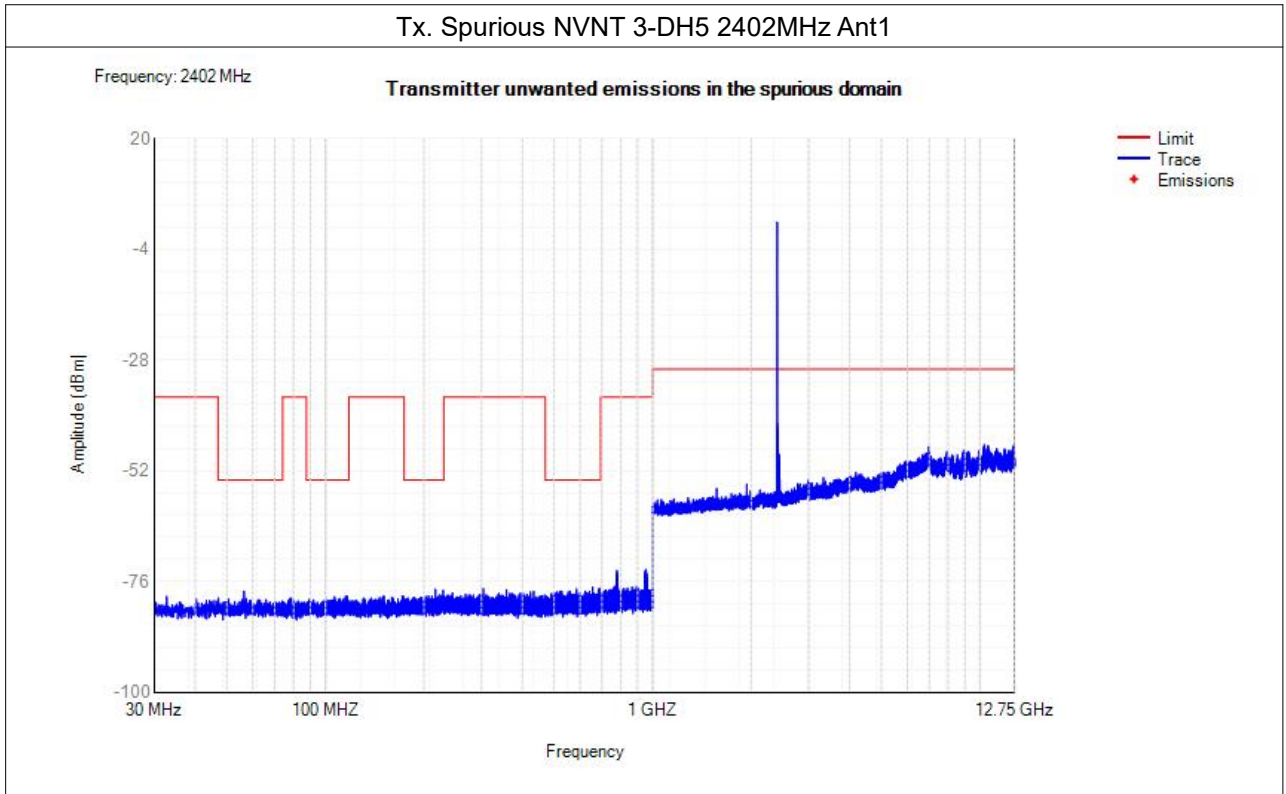

**Note:** All the modes had been tested, but only the worst data recorded in the report.

**Radiated Method:**

(Worst Case: GFSK\_Low channel)

below 1 GHz				
Maximum Frequency	Spurious Emission polarization and Level		Limit	Over Limit
MHz	polarization	dBm	dBm	dB
44.678	Vertical	-68.40	-54	-14.40
166.010	Vertical	-69.92	-36	-33.92
498.348	Vertical	-66.03	-36	-30.03
103.852	Horizontal	-62.58	-36	-26.58
215.996	Horizontal	-68.36	-36	-32.36
528.092	Horizontal	-66.00	-36	-30.00
Above 1 GHz				
Maximum Frequency	Spurious Emission polarization and Level		Limit	Over Limit
MHz	polarization	dBm	dBm	dB
4804.00	Vertical	-40.77	-30	-11.32
7206.00	Vertical	-46.17	-30	-16.63
4804.00	Horizontal	-40.32	-30	-10.18
7206.00	Horizontal	-39.62	-30	-10.39

(Worst Case: GFSK\_High channel)

below 1 GHz				
Maximum Frequency	Spurious Emission polarization and Level		Limit	Over Limit
MHz	polarization	dBm	dBm	dB
44.188	Vertical	-69.04	-54	-15.04
166.254	Vertical	-70.38	-36	-34.38
497.615	Vertical	-66.12	-36	-30.12
104.294	Horizontal	-62.53	-36	-26.53
215.880	Horizontal	-68.70	-36	-32.70
527.650	Horizontal	-66.41	-36	-30.41
Above 1 GHz				
Maximum Frequency	Spurious Emission polarization and Level		Limit	Over Limit
MHz	polarization	dBm	dBm	dB
4960.00	Vertical	-41.37	-30	-11.37
7440.00	Vertical	-46.87	-30	-16.87
4960.00	Horizontal	-40.04	-30	-10.04
7440.00	Horizontal	-40.13	-30	-10.13

**Note:**

- 1.Others emission at least have 20dBm margin. No recording in the test report.
- 2.All the modes had been tested, but only the worst data recorded in the report.

## Appendix K. Receiver spurious emissions

Measurement Data:

Test Data of Receiver Spurious Emissions (Conducted Method)							
Mode	Frequency (MHz)	Antenna	Range (MHz)	Spur Freq (MHz)	Peak (dBm)	Limit (dBm)	Verdict
1-DH5	2402	Ant1	30 -1000	810.45	-76.63	-57	Pass
1-DH5	2402	Ant1	1000 -12750	11190.5	-57.88	-47	Pass
1-DH5	2480	Ant1	30 -1000	810.75	-75.24	-57	Pass
1-DH5	2480	Ant1	1000 -12750	10554.5	-57.56	-47	Pass

### Test Graphs of Receiver Spurious Emissions (Conducted Method)

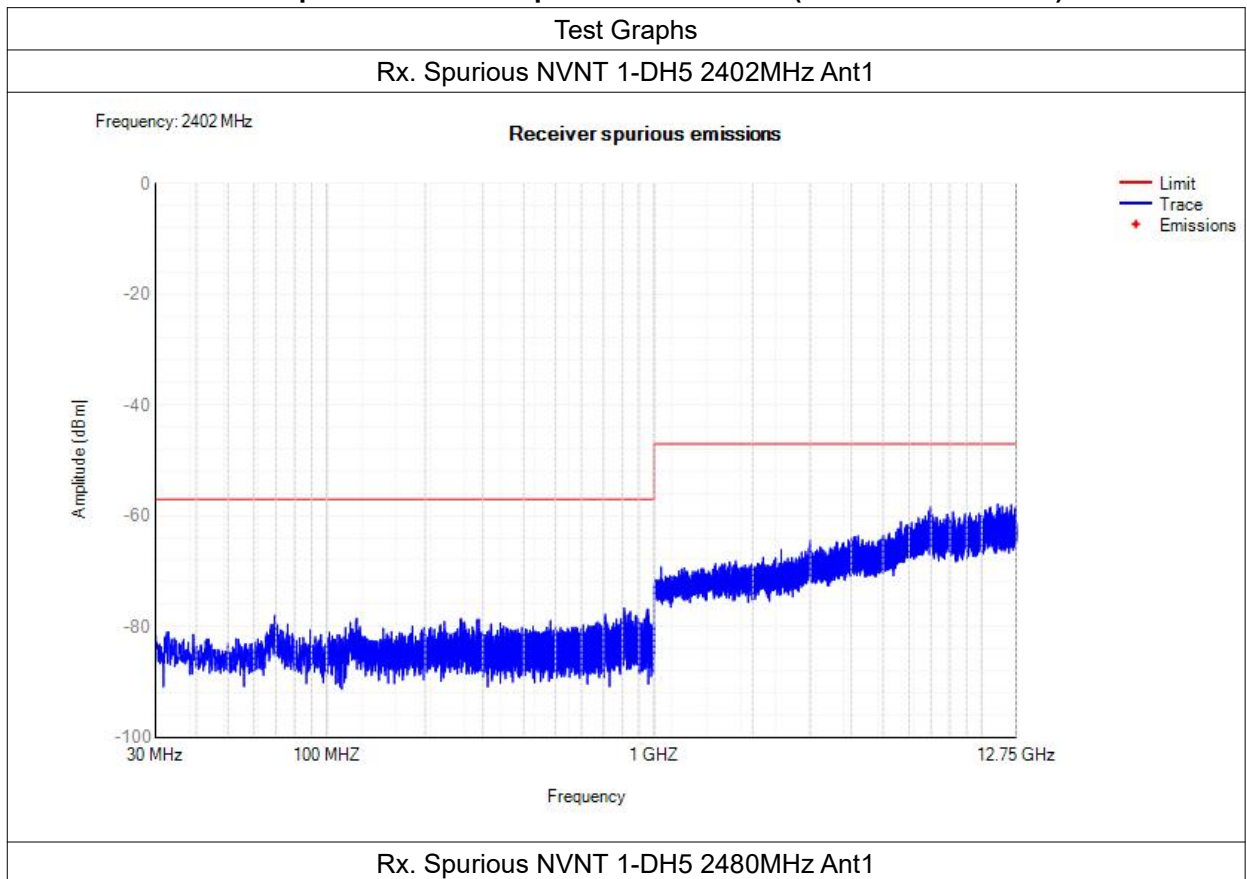

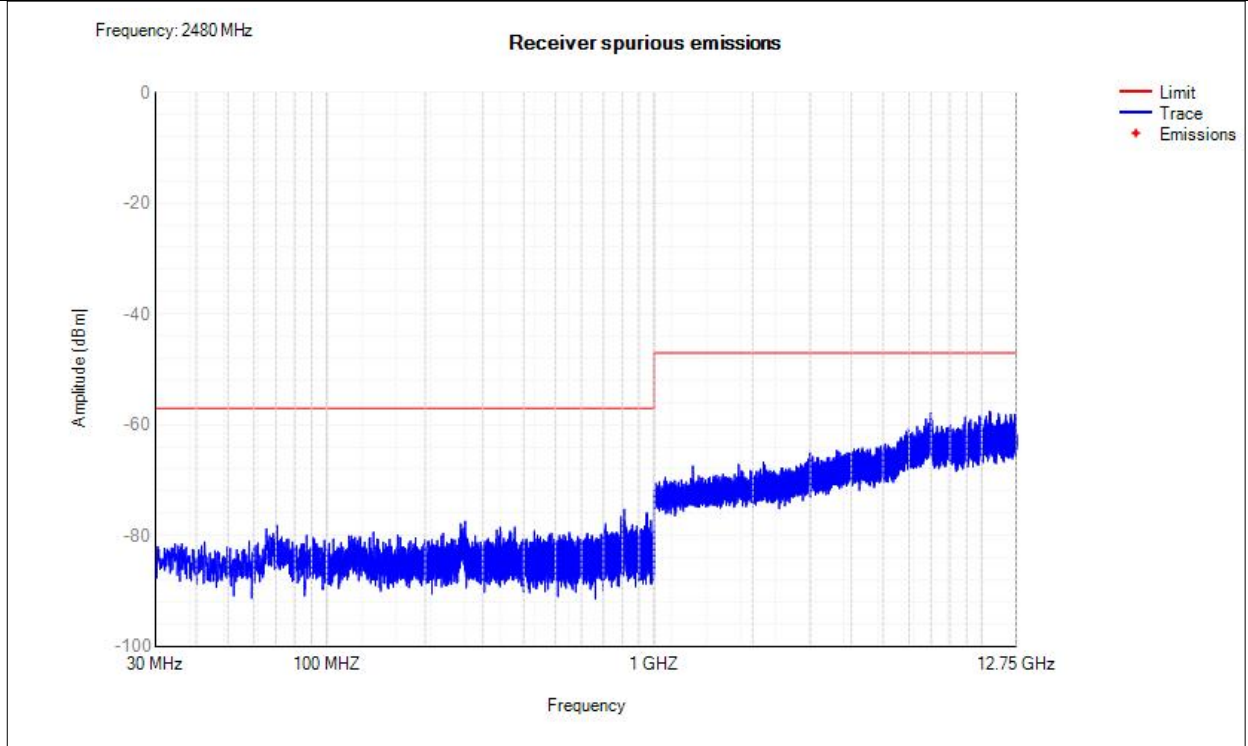

**Note:** All the modes had been tested, but only the worst data recorded in the report.



Radiated Method:

(Worst Case: GFSK\_Low channel)

below 1 GHz				
Maximum Frequency	Spurious Emission polarization and Level		Limit	Over Limit
	MHz	polarization		
270.17	Vertical	-63.32	-57	-6.32
1470.74	Vertical	-66.22	-57	-9.22
3153.18	Vertical	-67.77	-57	-10.77
359.00	Horizontal	-64.81	-57	-7.81
1825.15	Horizontal	-66.80	-57	-9.80
3178.59	Horizontal	-65.89	-57	-8.89
Above 1 GHz				
Maximum Frequency	Spurious Emission polarization and Level		Limit	Over Limit
	MHz	polarization		
1954.82	Vertical	-65.06	-47	-18.06
2818.04	Vertical	-65.69	-47	-18.69
5192.31	Vertical	-63.40	-47	-16.40
2085.82	Horizontal	-65.34	-47	-18.34
2755.34	Horizontal	-63.31	-47	-16.31
4902.52	Horizontal	-65.38	-47	-18.38

Note: 1. The margins of the other spectrum are not exceeding the minimum value of margin, and this part of the results without recording in the test report.

2. Measurements above show only up to 6 maximum emissions noted, or would be lesser, with "--" remark, if no specific emission from the EUT are recorded (ie: margin>20dB from the applicable limit) and considered that's already beyond the background noise floor.

(Worst Case: GFSK\_High channel)

below 1 GHz				
Maximum Frequency	Spurious Emission polarization and Level		Limit	Over Limit
	MHz	polarization		
1954.60	Vertical	-64.65	-47	-17.65
2817.19	Vertical	-65.30	-47	-18.30
5191.60	Vertical	-63.84	-47	-16.84
2085.01	Horizontal	-65.00	-47	-18.00
2756.05	Horizontal	-63.39	-47	-16.39
4902.13	Horizontal	-65.87	-47	-18.87
Above 1 GHz				
Maximum Frequency	Spurious Emission polarization and Level		Limit	Over Limit
	MHz	polarization		
1484.524	Vertical	-58.28	-47.00	-11.28
2946.549	Vertical	-56.22	-47.00	-9.22
5150.341	Vertical	-52.64	-47.00	-5.64
2534.197	Horizontal	-52.03	-47.00	-5.03
2688.43	Horizontal	-58.8	-47.00	-11.8
5241.555	Horizontal	-50.82	-47.00	-3.82

Note: 1. The margins of the other spectrum are not exceeding the minimum value of margin, and this part of the results without recording in the test report.

2. Measurements above show only up to 6 maximum emissions noted, or would be lesser, with "--" remark, if no specific emission from the EUT are recorded (ie: margin>20dB from the applicable limit) and considered that's already beyond the background noise floor.

## Appendix L. Receiver Blocking

Measurement Data:

Test Condition	Blocking Signal Frequency(MHz)	Blocking Signal Power(dBm)	Wanted signal mean power from companion device(dBm)	Performance PER	Limit PER	Result
GFSK Hopping Mode	2 300	-30.73	-69.16	0.19%	10%	Pass
	2 380	-30.73	-69.16	0.23%	10%	
	2 504	-30.73	-69.15	0.08%	10%	
	2 584	-30.73	-69.15	0.22%	10%	

Test Condition	Blocking Signal Frequency(MHz)	Blocking Signal Power(dBm)	Wanted signal mean power from companion device(dBm)	Performance PER	Limit PER	Result
$\pi/4$ -DQPSK Hopping Mode	2 300	-30.73	-67.30	0.28%	10%	Pass
	2 380	-30.73	-67.30	0.26%	10%	
	2 504	-30.73	-67.28	0.13%	10%	
	2 584	-30.73	-67.28	0.31%	10%	

Test Condition	Blocking Signal Frequency(MHz)	Blocking Signal Power(dBm)	Wanted signal mean power from companion device(dBm)	Performance PER	Limit PER	Result
8-DPSK Hopping Mode	2 300	-30.73	-67.26	0.58%	10%	Pass
	2 380	-30.73	-67.26	0.59%	10%	
	2 504	-30.73	-67.25	0.25%	10%	
	2 584	-30.73	-67.25	0.12%	10%	

Note: The levels of the blocking signal and wanted signal have to be corrected for the (in-band) antenna assembly gain.

## 7 Test Setup photograp

RADIATED EMISSION TEST SETUP

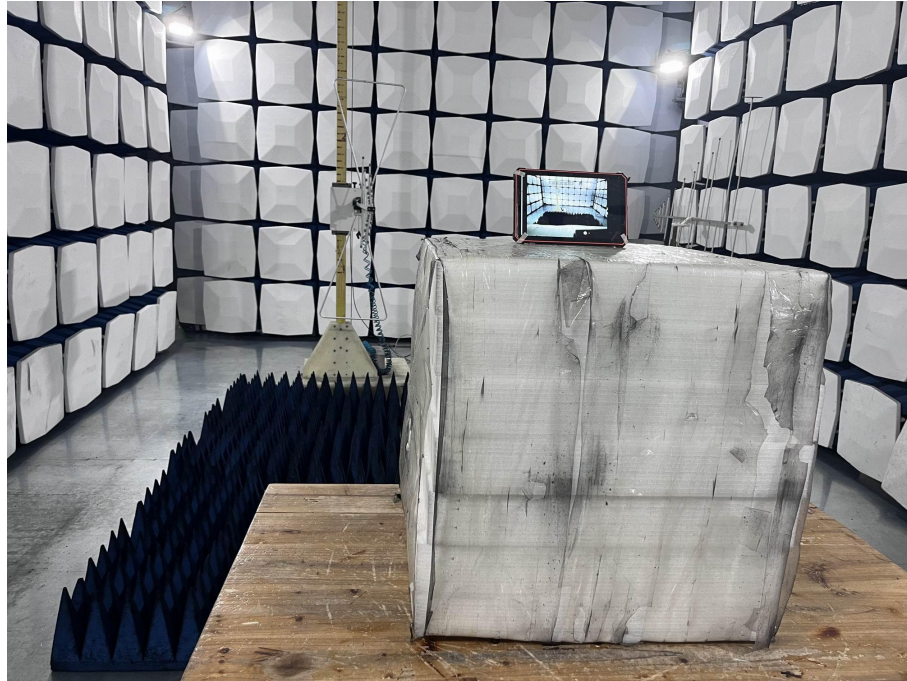

RADIATED EMISSION ABOVE 1G TEST SETUP

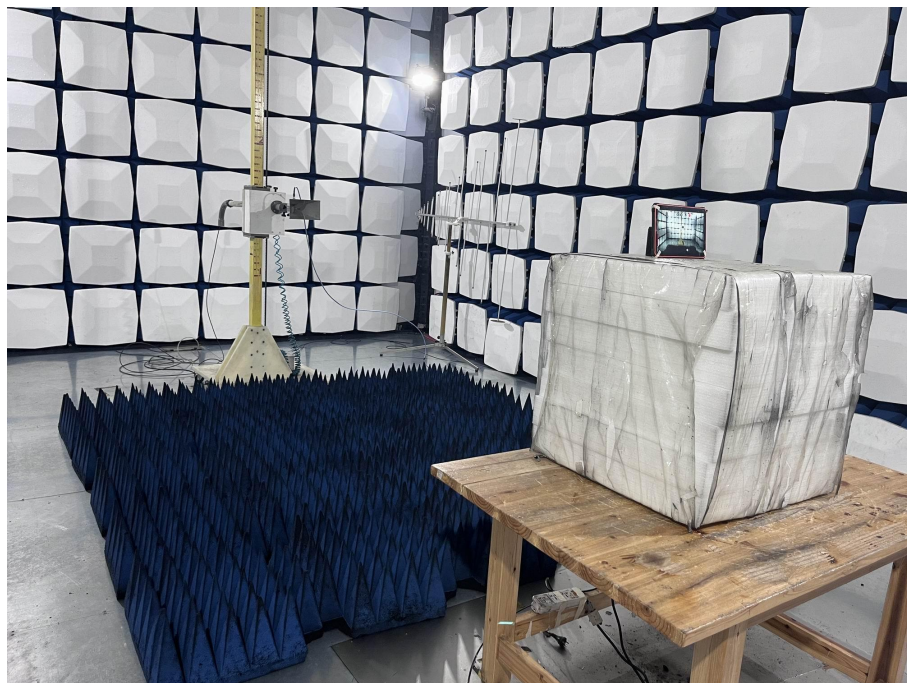

-----END OF REPORT-----