

Radio Test Report-BLE

ETSI EN 300 328 V2.2.2 (2019-07)

Client Information:

Applicant: DOKE COMMUNICATION (HK) LIMITED
Applicant add.: RM 1902 EASEY COMM BLDG 253-261 HENNESSY ROAD WANCHAI HK
CHINA

Product Information:

Product Name: Tablet
Model No.: Tab 11 WIFI
Serial Model: N/A
Brand Name: Blackview
Report No.: AIT23042604-1

Prepared By:

Dongguan Yaxu (AiT) Technology Limited

No.22, Jinqianling Third Street, Jitigang, Huangjiang, Dongguan,
Guangdong, China

Tel.: +86-769-8202 0499 Fax.: +86-769-8202 0495

Date of Receipt: 2023.04.26

Date of Test: 2023.04.27~2023.05.23

Date of Issue: 2023.05.23

Test Result: Pass

This device has been tested and found to comply with the stated standard(s), which is (are) required by the council directive of 2014/53/EU and indicated in the test report and are applicable only to the tested sample identified in the report.

Note: This report shall not be reproduced except in full, without the written approval of Dongguan Yaxu (AiT) Technology Limited, this document may be altered or revised by Dongguan Yaxu (AiT) Technology Limited, personal only, and shall be noted in the revision of the document. This test report must not be used by the client to claim product endorsement.

Reviewed by:



Simba huang

Approved by:



Seal.chen

REPORT REVISE RECORD

Report Version	Revise Time	Issued Date	Valid Version	Notes
V1.0	/	2023.05.23	Valid	Initial release

Contents

	Page
CONTENTS	3
1 TEST SUMMARY	5
1.1 Compliance with ETSI EN 300 328 V2.2.2 (2019-07).....	5
2 TEST FACILITY	6
2.1 Deviation from standard.....	6
2.2 Abnormalities from standard conditions.....	6
3 GENERAL INFORMATION	7
3.1 Description of Test setup.....	8
3.2 EUT Peripheral List.....	8
3.3 Test Peripheral List.....	8
4 EQUIPMENT USED DURING TEST	9
5 RADIO TECHNICAL REQUIREMENTS SPECIFICATION IN EN 300 328	10
5.1 Transmitter Conditions.....	10
5.2 Test conditions.....	10
5.2.1 Normal conditions.....	10
5.2.2 Extreme conditions.....	10
5.2.3 Measurement Uncertainty.....	11
5.3 Test frequencies.....	11
5.4 Transmitter Requirements.....	12
5.4.1 RF Output Power.....	12
5.4.2 Power Spectral Density.....	14
5.4.3 Duty Cycle, Tx-sequence, Tx-gap.....	16
5.4.4 Medium Utilisation (MU) factor.....	16
5.4.5 Occupied Channel Bandwidth.....	17
5.4.6 Transmitter unwanted emissions in the out-of-band domain.....	19
5.4.7 Transmitter unwanted emission in the spurious domain.....	22
5.5 Receiver Requirements.....	26
5.5.1 Receiver Spurious Emissions.....	26
5.6 Adaptivity.....	30
5.7 Receiver Blocking.....	32
5.7.1 Performance Criteria.....	32
5.7.2 Limit(ETSI EN 300 328 V2.2.2 (2019-07) Clause 4.3.2.11.4).....	32
5.7.3 Test procedure.....	33
5.7.4 Test Setup.....	34
5.7.5 Test result.....	35
6 APPENDIX TEST DATA	36
Appendix A. RF Output Power (E.I.R.P.).....	36
Appendix B. Power Spectral Density.....	36
Appendix C. Occupied Channel Bandwidth.....	40



Appendix D. Transmitter unwanted emissions in the OOB domain	43
Appendix E. Transmitter unwanted emissions in the spurious domain	47
Appendix F. Receiver spurious emissions	53
Appendix G. Receiver Blocking	57
7 TEST SETUP PHOTOGRAPHS	58

1 Test Summary

1.1 Compliance with ETSI EN 300 328 V2.2.2 (2019-07)

RADIO SPECTRUM MATTER (RSM) PART					
Test	Test Requirement	Test method	Limit/Severity	Uncertainty	Result
RF Output Power	EN 300 328 clause 4.3.1.2	EN 300 328 clause 5.4.2	≤20dBm	± 1.5dB	PASS
Power Spectral Density	EN 300 328 clause 4.3.2.3	EN 300 328 clause 5.4.3	10 dBm/MHz	± 3dB	PASS
Duty Cycle, Tx-sequence, Tx-gap	EN 300 328 clause 4.3.2.4	EN 300 328 clause 5.4.2	EN 300 328 clause 4.3.2.4.3	± 5 %	N/A
Medium Utilisation (MU) factor	EN 300 328 clause 4.3.2.5	EN 300 328 clause 5.4.2	EN 300 328 clause 4.3.2.5.3	±3dB	N/A
Adaptivity (adaptive equipment using modulations other than FHSS)	EN 300 328 clause 4.3.2.6	EN 300 328 clause 5.4.6	EN 300 328 clause 4.3.2.6	±3dB	PASS
Occupied Channel Bandwidth	EN 300 328 clause 4.3.2.7	EN 300 328 clause 5.4.7	Fall in band	± 5 %	PASS
Transmitter unwanted emissions in the out-of-band domain	EN 300 328 clause 4.3.2.8	EN 300 328 clause 5.4.8	figure 3	±3dB	PASS
Transmitter unwanted emission in the spurious domain	EN 300 328 clause 4.3.2.9	EN 300 328 clause 5.4.9	Table 12	± 3dB	PASS
Geo-location capability	EN 300 328 Clause 4.3.2.12.2	N/A	N/A	N/A	N/A
Radio Spectrum Matter (RSM) Part of Rx					
Test	Test Requirement	Test method	Limit/Severity	Uncertainty	Result
Receiver Spurious Emissions	EN 300 328 clause 4.3.2.10	EN 300 328 clause 5.4.10	Table 13	± 6dB	PASS
Receiver Blocking	EN 300 328 clause 4.3.2.11	EN 300 328 clause 5.4.11	Table 14, 15, 16	±3dB	PASS

Remark:

N/A: not applicable. Refer to the relevant section for the details.

EN 300 328: the detail version is ETSI EN 300 328 V2.2.2 (2019-07) in the whole report.

Tx: In this whole report Tx (or tx) means Transmitter.

Rx: In this whole report Rx (or rx) means Receiver.

RF: In this whole report RF means Radio Frequency.

The EUT belongs to the list of 'Class-1' equipment in accordance with the Commission Decision 2000/299/EC (6 April 2000).

Temperature (Uncertainty): ±1°C

Humidity (Uncertainty): ±5%

2 Test Facility

The test facility is recognized, certified or accredited by the following organizations:

.CNAS- Registration No: L6177

Dongguan Yaxu (AiT) technology Limited is accredited to ISO/IEC 17025:2017 general Requirements for the competence of testing and calibration laboratories (CNAS-CL01 Accreditation Criteria for the competence of testing and calibration laboratories) on April 17, 2022

FCC-Registration No.: 703111 Designation Number: CN1313

Dongguan Yaxu (AiT) technology Limited has been registered and fully described in a report filed with the (FCC) Federal Communications Commission. The acceptance letter from the FCC is maintained in our files.

IC —Registration No.: 6819A CAB identifier: CN0122

The 3m Semi-anechoic chamber of Dongguan Yaxu (AiT) technology Limited has been registered by Certification and Engineering Bureau of Industry Canada for radio equipment testing with Registration No.: 6819A

A2LA-Lab Cert. No.: 6317.01

Dongguan Yaxu (AiT) technology Limited has been accredited by A2LA for technical competence in the field of electrical testing, and proved to be in compliance with ISO/IEC 17025: 2017 General Requirements for the Competence of Testing and Calibration Laboratories and any additional program requirements in the identified field of testing.

2.1 Deviation from standard

None

2.2 Abnormalities from standard conditions

None

3 General Information

Manufacturer	Shenzhen DOKE Electronic Co., Ltd
Manufacturer Address	801, Building3, 7th Industrial Zone, Yulv Community, Yutang Road, Guangming District, Shenzhen, China
EUT Name:	Tablet
Model No	Tab 11 WIFI
Serial Model	N/A
Difference Description	N/A
Brand Name	Blackview
Bluetooth version	V4.2
Operation frequency	2402 MHz to 2480 MHz
Channel Number	40
Modulation Type	GFSK
The type of the equipment	non-FHSS adaptive equipment with only one antenna
Antenna Designation	FPC antenna
Antenna Gain:	1.0dBi
Hardware Version	WT_DK047_8183_BED_UMCP_MB_V2.0
Software Version	Tab11WiFi_NEU_MT8183_V1.0
Power Supply	DC 3.8V 8380mAh for Battery
Maximum Output Power	-0.09dBm(0.0009W)

Note:

1.For a more detailed features description, please refer to the manufacturer' s specifications or the User's Manual.

3.1 Description of Test setup

EUT was tested in normal configuration (Please See following Block diagrams)

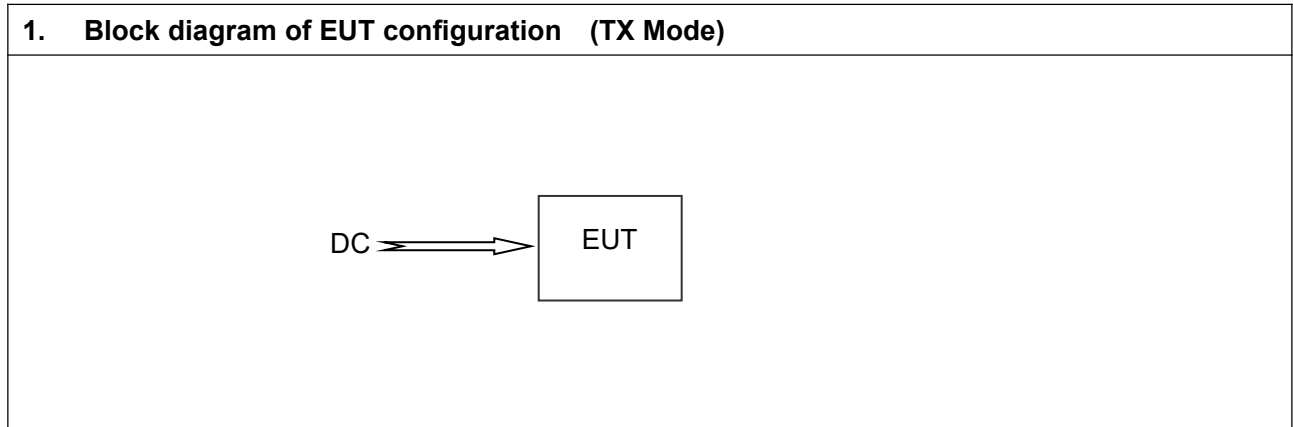

3.2 EUT Peripheral List

No.	Equipment	Manufacturer	EMC Compliance	Model No.	Serial No.	Power cord	Signal cord
1	N/A	N/A	N/A	N/A	N/A	N/A	N/A

3.3 Test Peripheral List

No.	Equipment	Manufacturer	EMC Compliance	Model No.	Serial No.	Power cord	Signal cord
1	PC	DELL	--	E7430	--	N/A	N/A

4 Equipment Used during Test

No	Test Equipment	Manufacturer	Model No	Serial No	Cal. Date	Cal. Due Date
1	Spectrum Analyzer	R&S	FSV40	101470	2022.09.02	2023.09.01
2	EMI Measuring Receiver	R&S	ESR	101160	2022.09.02	2023.09.01
3	Low Noise Pre Amplifier	HP	HP8447E	AiT-F01319	2022.09.02	2023.09.01
4	Low Noise Pre Amplifier	Tsj	MLA-0120-A02-34	2648A04738	2022.09.02	2023.09.01
5	Passive Loop	ETS	6512	00165355	2022.09.04	2024.09.03
6	TRILOG Super Broadband test Antenna	SCHWARZBECK	VULB9160	9160-3206	2021.08.29	2024.08.28
7	Broadband Horn Antenna	SCHWARZBECK	BBHA9120D	452	2021.08.29	2024.08.28
8	SHF-EHF Horn Antenna 15-40GHz	SCHWARZBECK	BBHA9170	BBHA9170367d	2020.11.24	2023.11.23
9	EMI Test Receiver	R&S	ESCI	100124	2022.09.02	2023.09.01
10	LISN	Kyoritsu	KNW-242	8-837-4	2022.09.02	2023.09.01
11	LISN	R&S	ESH3-Z2	0357.8810.54 - 101161-S2	2022.09.02	2023.09.01
12	Pro.Temp&Humi.chamber	MENTEK	MHP-150-1C	MAA08112501	2022.09.02	2023.09.01
13	RF Automatic Test system	MW	MW100-RFCB	21033016	2022.09.02	2023.09.01
14	Signal Generator	Agilent	N5182A	MY50143009	2022.09.02	2023.09.01
15	Wideband Radio communication tester	R&S	CMW500	1201.0002K50	2022.09.02	2023.09.01
16	RF Automatic Test system	MW	MW100-RFCB	21033016	2022.09.02	2023.09.01
17	DC power supply	ZHAOXIN	RXN-305D-2	28070002559	N/A	N/A
18	RE Software	EZ	EZ-EMC_RE	Ver.AIT-03A	N/A	N/A
19	CE Software	EZ	EZ-EMC_CE	Ver.AIT-03A	N/A	N/A
20	RF Software	MW	MTS 8310	2.0.0.0	N/A	N/A

5 Radio Technical Requirements Specification in EN 300 328

5.1 Transmitter Conditions

Item	EUT Type
1	stand-alone radio equipment with or without their own control provisions;
2	plug-in radio devices intended for use with or within a variety of host systems, e.g. personal computers, hand-held terminals, etc.;
3	plug-in radio devices intended for use within combined equipment, e.g. cable modems, set-top boxes, access points, etc.;
4	Combined equipment or a combination of a plug-in radio device and a specific type of host equipment.

Modulation
DSSS

EUT belongs to item 1 with DSSS modulation.

5.2 Test conditions

5.2.1 Normal conditions

Ambient:	Temperature:	+15°C to +35°C
	Relative humidity:	20% to 75%
	Press:	1010 mbar
Power supply:	DC	3.85V

5.2.2 Extreme conditions

Ambient:	Temperature:	-10 °C to +50 °C (Which declared by manufacture)
Power supply:	DC	3.49V ~4.25V

5.2.3 Measurement Uncertainty

No.	Item	Uncertainty
1	Conducted Emission Test	1.20dB
2	Radiated Emission Test	3.30dB
3	RF power,conducted	0.16dB
4	RF power density,conducted	0.24dB
5	Spurious emissions,conducted	0.21dB
6	All emissions,radiated(<1G)	4.68dB
7	All emissions,radiated(>1G)	4.89dB

5.3 Test frequencies

EUT channels and frequencies list:

Channel	Frequency (MHz)	Channel	Frequency (MHz)
0	2402	20	2442
1	2404	21	2444
2	2406	22	2446
3	2408	23	2448
4	2410	24	2450
5	2412	25	2452
6	2414	26	2454
7	2416	27	2456
8	2418	28	2458
9	2420	29	2460
10	2422	30	2462
11	2424	31	2464
12	2426	32	2466
13	2428	33	2468
14	2430	34	2470
15	2432	35	2472
16	2434	36	2474
17	2436	37	2476
18	2438	38	2478
19	2440	39	2480

Test frequencies are the lowest channel: 0 channel(2402MHz), middle channel: 19 channel(2440 MHz) and highest channel: 39 channel(2480 MHz)

5.4 Transmitter Requirements

5.4.1 RF Output Power

Test requirement: EN 300 328 clause 4.3.2.2

Test Method: EN 300 328 clause 5.4.2

EUT Operation:

Status: Enter test mode for the product. Test in lowest channel 2402 MHz, middle channel 2440 MHz and highest channel 2480 MHz, keep in continuously transmitting status with normal modulation.

Conducted measurement for this kind of products which be used for integral antenna equipment connect to the measuring equipment.

Test setup:

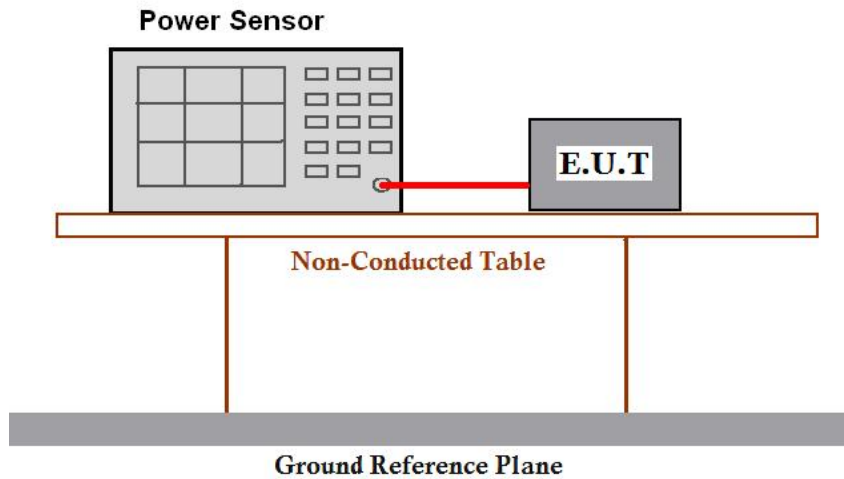

Test procedure:

1. Remove the antenna from the EUT and then connect a low attenuation RF cable from the antenna port to the spectrum.
2. Use a fast power sensor suitable for 2, 4 GHz and capable of 1 MS/s.
3. Sample speed 1 MS/s or faster, and must represent the power of the signal.
4. For adaptive equipment, the measurement duration shall be long enough to ensure a minimum number of bursts (at least 10) are captured.
5. For conducted measurements on devices with one transmit chain:
 - Connect the power sensor to the transmit port, sample the transmit signal and store the raw data. use these stored samples in all following steps.
6. For conducted measurements on devices with multiple transmit chains:
 - Connect one power sensor to each transmit port for a synchronous measurement on all transmits

ports.

-Trigger the power sensors so that they start sampling at the same time. Make sure the time difference between the samples of all sensors is less than half the time between two samples.

-For each instant in time, sum the power of the individual samples of all ports and store them. Use these stored samples in all following steps.

7. Find the start and stop times of each burst in the stored measurement samples.
8. Between the start and stop times of each individual burst calculate the RMS power over the burst. Save these Pburst values, as well as the start and stop times for each burst.
9. The highest of all Pburst values (value "A" in dBm) will be used for maximum e.i.r.p. calculations.
10. Add the (stated) antenna assembly gain "G" in dBi of the individual antenna, If applicable, add the additional beamforming gain "Y" in dB.
11. If more than one antenna assembly is intended for this power setting, the maximum overall antenna gain (G or G + Y) shall be used.
12. The RF Output Power (P) shall be calculated using the formula below: $P = A + G + Y$
13. Keep the EUT in transmitting at lowest, middle and highest channel individually. Record the max value.

5.4.1.1 Measurement Record:

Note: For test data, please refer to the appendix results.

5.4.2 Power Spectral Density

Test requirement: EN 300 328 clause 4.3.2.3

Test Method: EN 300 328 clause 5.4.3

EUT Operation:

Status: Enter test mode for the product. Test in lowest Channel 2402MHz, middle Channel 2440MHz and highest Channel 2480MHz, keep in continuously transmitting status.

Conducted measurement for this kind of products which be used for integral antenna equipment connect to the measuring equipment.

Test setup:

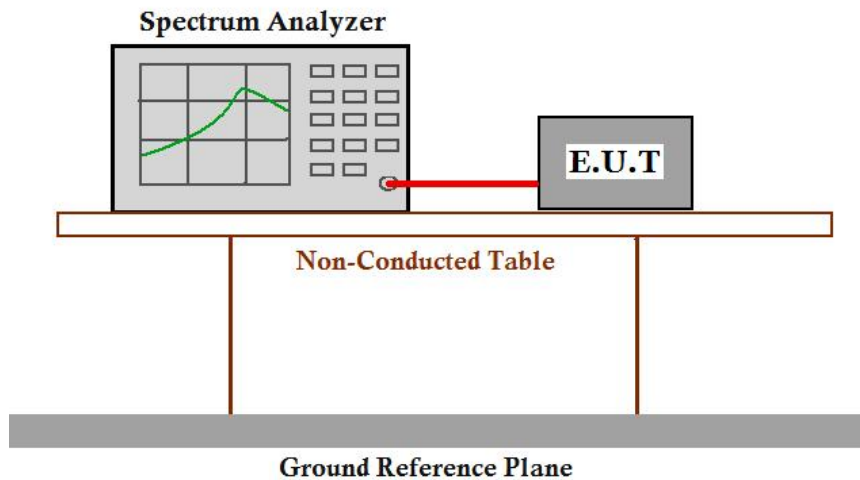

Test Procedure:

1. Remove the antenna from the EUT and then connect a low attenuation RF cable from the antenna port to the spectrum.

- Start Frequency: 2 400 MHz
- Stop Frequency: 2 483,5 MHz
- Resolution BW: 10 kHz
- Video BW: 30 kHz
- Sweep Points: > 8 350

NOTE: For spectrum analysers not supporting this number of sweep points, the frequency band may be segmented.

- Detector: RMS
- Trace Mode: Max Hold
- Sweep time: Auto

For non-continuous signals, wait for the trace to be completed. Save the (trace) data set to a file.

2. For conducted measurements on smart antenna systems using either operating mode 2 or 3 (see clause 5.1.3.2), repeat the measurement for each of the transmit ports. For each frequency point, add up the amplitude (power) values for the different transmit chains and use this as the new data set.
3. Add up the values for amplitude (power) for all the samples in the file.
4. Normalize the individual values for amplitude so that the sum is equal to the RF Output Power (e.i.r.p.) measured in clause 5.4.2..
5. Starting from the first sample in the file (lowest frequency), add up the power of the following samples representing a 1 MHz segment and record the results for power and position (i.e. sample #1 to #100). This is the Power Spectral Density (e.i.r.p.) for the first 1 MHz segment which shall be recorded.
6. Shift the start point of the samples added up in step 5 by 1 sample and repeat the procedure in step 5 (i.e. sample #2 to #101).
7. Repeat step 6 until the end of the data set and record the radiated Power Spectral Density values for each of the 1 MHz segments. From all the recorded results, the highest value is the maximum Power Spectral Density for the UUT. This value, which shall comply with the limit given in clause 4.3.2.3.3, shall be recorded in the test report..
8. Keep the EUT in transmitting at lowest, middle and highest channel individually.

5.4.2.1 Measurement Record

Note: For test data, please refer to the appendix results.

5.4.3 Duty Cycle, Tx-sequence, Tx-gap

N/A: not applicable. Refer to the EN 300 328 clause 4.3.2.4 section for the details.

These requirements apply to non-adaptive equipment or to adaptive equipment when operating in a non-adaptive mode. The equipment is using wide band modulations other than FHSS.

These requirements do not apply for equipment with a maximum declared RF Output power of less than 10 dBm e.i.r.p. or for equipment when operating in a mode where the RF Output power is less than 10 dBm e.i.r.p.

As the EUT belongs to Adaptive equipment type, so the test is not applicable and skipped.

5.4.4 Medium Utilisation (MU) factor

N/A: not applicable. Refer to the EN 300 328 clause 4.3.1.6 section for the details.

This requirement does not apply to adaptive equipment unless operating in a non-adaptive mode.

In addition, this requirement does not apply for equipment with a maximum declared RF Output power level of less than 10 dBm e.i.r.p. or for equipment when operating in a mode where the RF Output power is less than 10 dBm e.i.r.p.

As the EUT belongs to Adaptive equipment type, so the test is not applicable and skipped.

5.4.5 Occupied Channel Bandwidth

Test requirement: EN 300 328 clause 4.3.2.7

Test Method: EN 300 328 clause 5.4.7

EUT Operation:

Status: Enter test mode for the product. Test in lowest channel 2402 MHz, and highest channel 2480 MHz, keep in continuously transmitting status with normal modulation.

Test setup:

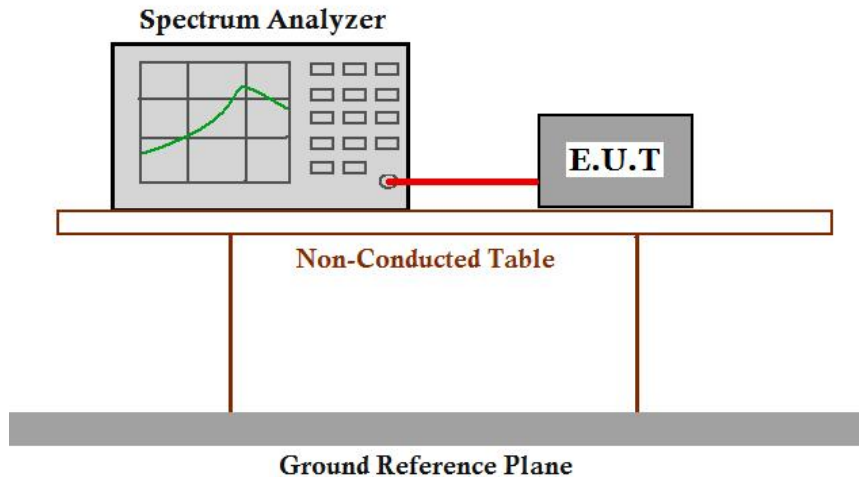

Test procedure:

1. Remove the antenna from the EUT and then connect a low attenuation RF cable from the antenna port to the spectrum and use the following settings:
 - Centre Frequency: The centre frequency of the channel under test
 - Resolution BW: ~ 1 % of the span without going below 1 %
 - Video BW: 3 × RBW
 - Frequency Span: 2 × Occupied Channel Bandwidth (e.g. 40 MHz for a 20 MHz channel)
 - Detector Mode: RMS
 - Trace Mode: Max Hold
2. Wait until the trace is completed, Find the peak value of the trace and place the analyser marker on this peak.
3. Use the 99 % bandwidth function of the spectrum analyser to measure the Occupied Channel Bandwidth of the UUT, this value shall be recorded.

NOTE: Make sure that the power envelope is sufficiently above the noise floor of the analyser to avoid the noise signals left and right from the power envelope being taken into account by this measurement.

5.4.5.1 Measurement Record:

Note: For test data, please refer to the appendix results.

5.4.6 Transmitter unwanted emissions in the out-of-band domain

Test requirement: EN 300 328 clause 4.3.2.8

Test Method: EN 300 328 clause 5.4.8.2.1

EUT Operation:

Status: Enter test mode for the product. Test in lowest Channel 2402MHz, highest Channel 2480MHz, keep in continuously transmitting status.

Test Setup:

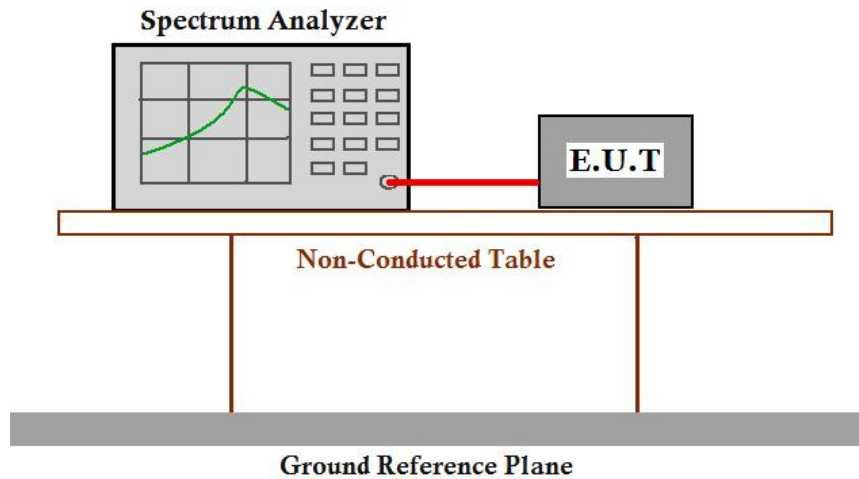

Test procedure:

1. Remove the antenna from the EUT and then connect a low attenuation RF cable from the antenna port to the spectrum and use the following settings:
 - Centre Frequency: 2 484 MHz
 - Span: 0 Hz
 - Resolution BW: 1 MHz
 - Filter mode: Channel filter
 - Video BW: 3 MHz
 - Detector Mode: RMS
 - Trace Mode: Clear / Write
 - Sweep Mode: Continuous
 - Sweep Points: 5 000
 - Trigger Mode: Video trigger

NOTE 1: In case video triggering is not possible, an external trigger source may be used.

- Sweep Time: Suitable to capture one transmission burst
2. segment 2 483,5 MHz to 2 483,5 MHz + BW
 - Adjust the trigger level to select the transmissions with the highest power level.
 - For frequency hopping equipment operating in a normal hopping mode, the different hops will result in signal bursts with different power levels. In this case the burst with the highest power level shall be selected.
 - Set a window (start and stop lines) to match with the start and end of the burst and in which the RMS power shall be measured using the Time Domain Power function.
 - Select RMS power to be measured within the selected window and note the result which is the RMS power within this 1 MHz segment (2 483,5 MHz to 2 484,5 MHz). Compare this value with the

applicable limit provided by the mask.

•Increase the centre frequency in steps of 1 MHz and repeat this measurement for every 1 MHz segment within the range 2 483,5 MHz to 2 483,5 MHz + BW. The centre frequency of the last 1 MHz segment shall be set to 2 483,5 MHz + BW - 0,5 MHz (which means this may partly overlap with the previous 1 MHz segment).

3. segment 2 483,5 MHz + BW to 2 483,5 MHz + 2BW

•Change the centre frequency of the analyser to 2 484 MHz + BW and perform the measurement for the first 1 MHz segment within range 2 483,5 MHz + BW to 2 483,5 MHz + 2BW. Increase the centre frequency in 1 MHz steps and repeat the measurements to cover this whole range. The centre frequency of the last 1 MHz segment shall be set to 2 483,5 MHz + 2 BW - 0,5 MHz.

4. segment 2 400 MHz - BW to 2 400 MHz

•Change the centre frequency of the analyser to 2 399,5 MHz and perform the measurement for the first 1 MHz segment within range 2 400 MHz - BW to 2 400 MHz. Reduce the centre frequency in 1 MHz steps and repeat the measurements to cover this whole range. The centre frequency of the last 1 MHz segment shall be set to 2 400 MHz - 2BW + 0,5 MHz.

5. segment 2 400 MHz - 2BW to 2 400 MHz - BW

•Change the centre frequency of the analyser to 2 399,5 MHz - BW and perform the measurement for the first 1 MHz segment within range 2 400 MHz - 2BW to 2 400 MHz - BW. Reduce the centre frequency in 1 MHz steps and repeat the measurements to cover this whole range. The centre frequency of the last 1 MHz segment shall be set to 2 400 MHz - 2BW + 0,5 MHz.

6. In case of conducted measurements on equipment with a single transmit chain, the declared antenna assembly gain "G" in dBi shall be added to the results for each of the 1 MHz segments and compared with the limits provided by the mask given in figures 1 or 3. If more than one antenna assembly is intended for this power setting, the antenna with the highest gain shall be considered.

•In case of conducted measurements on smart antenna systems (equipment with multiple transmit chains), the measurements need to be repeated for each of the active transmit chains. The declared antenna assembly gain "G" in dBi for a single antenna shall be added to these results. If more than one antenna assembly is intended for this power setting, the antenna with the highest gain shall be considered. Comparison with the applicable limits shall be done using any of the options given below:

- Option 1: the results for each of the transmit chains for the corresponding 1 MHz segments shall be added. The additional beamforming gain "Y" in dB shall be added as well and the resulting values compared with the limits provided by the mask given in figures 1 or 3.

- Option 2: the limits provided by the mask given in figures 1 or 3 shall be reduced by $10 \times \log_{10}(A_{ch})$ and the additional beamforming gain "Y" in dB. The results for each of the transmit chains shall be individually compared with these reduced limits.

NOTE 2: A_{ch} refers to the number of active transmit chains.

It shall be recorded whether the equipment complies with the mask provided in figures 1 or 3.

5.4.6.1 Measurement Record:

Note: For test data, please refer to the appendix results.

Remark:

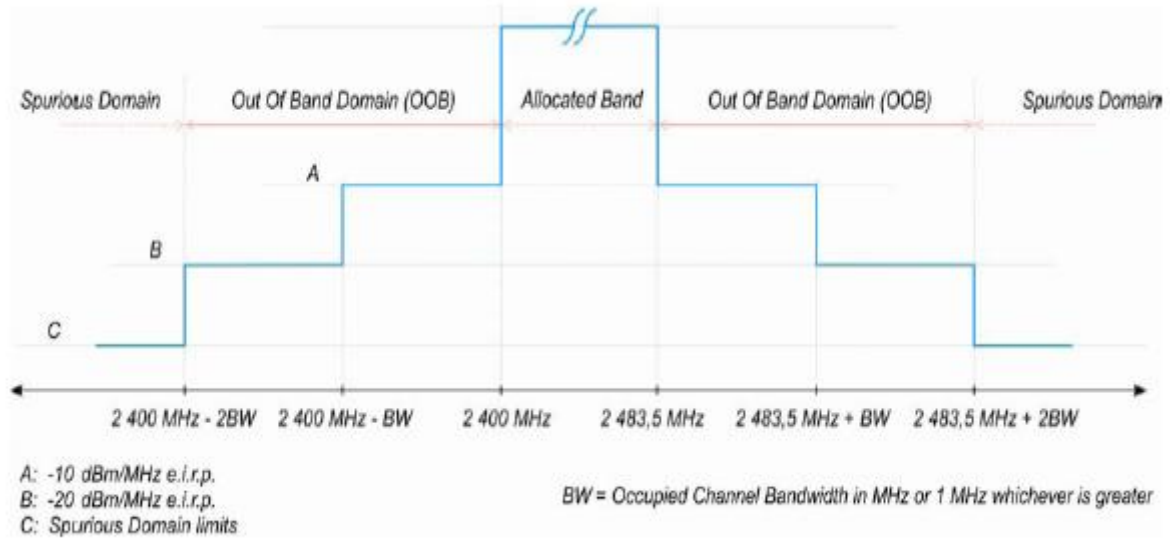

These measurements have to be performed at normal environmental conditions and shall be repeated at the extremes of the operating temperature range.

5.4.7 Transmitter unwanted emission in the spurious domain

Test requirement: EN 300 328 clause 4.3.2.9

Test Method: EN 300 328 clause 5.4.9.2.2

EUT Operation:

Status: Enter test mode for the product. Test in lowest Channel 2402MHz, highest Channel 2480MHz, keep in continuously transmitting status.

Test Setup:

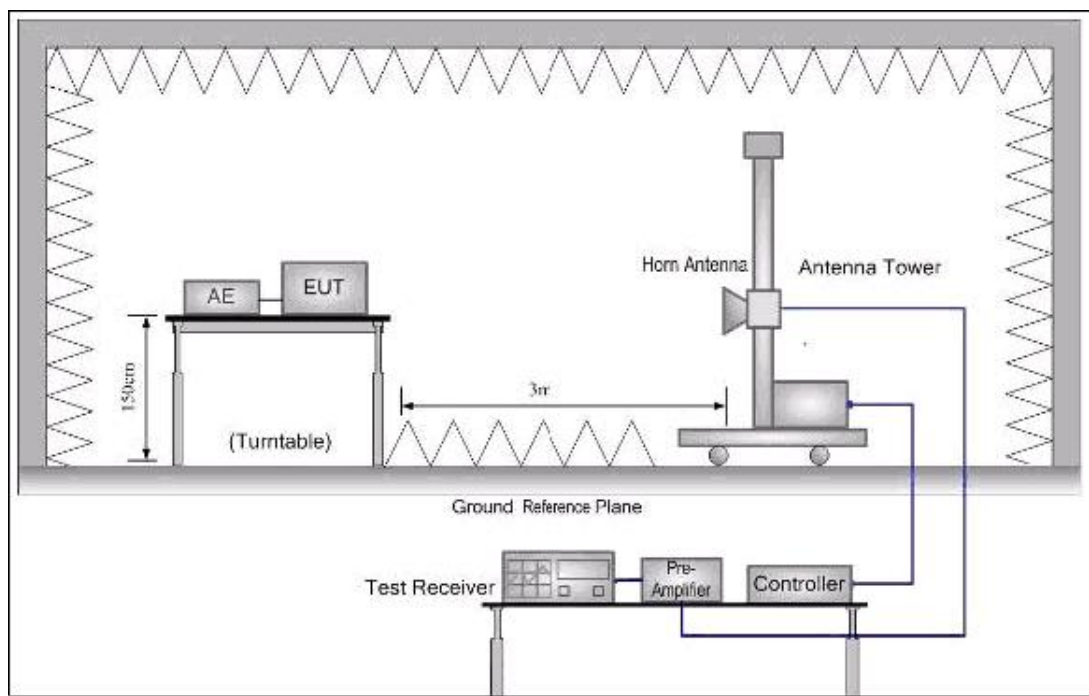
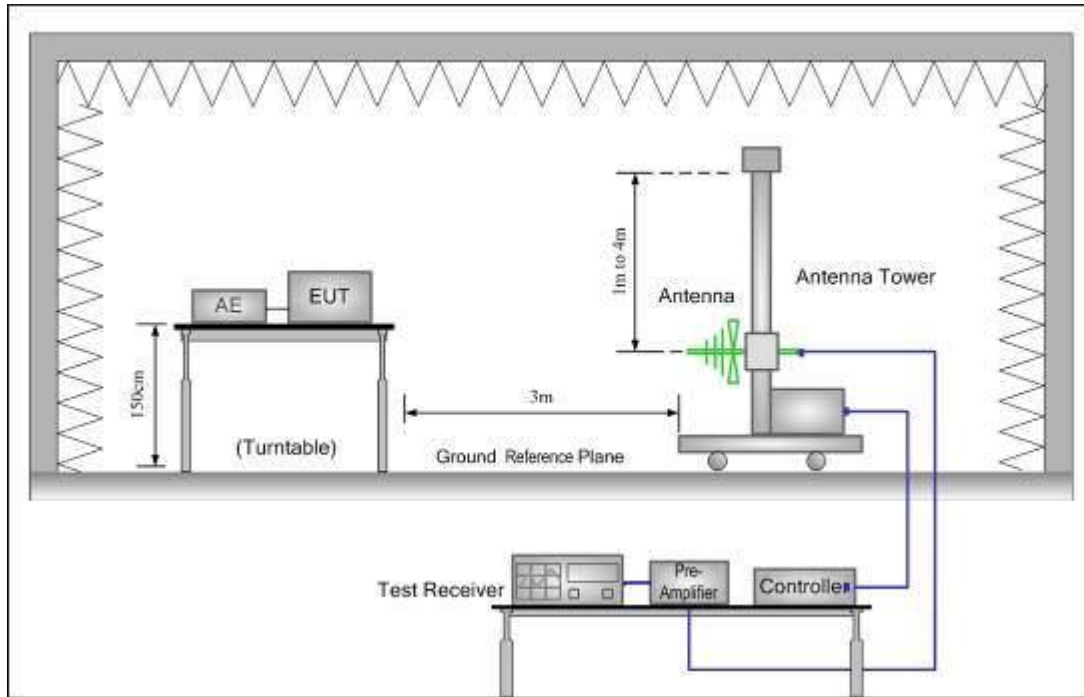

Test procedure:

1. Remove the antenna from the EUT and then connect a low attenuation RF cable from the antenna port to the spectrum;
2. Pre-scan

The test procedure below shall be used to identify potential unwanted emissions of the UUT.

Pre-scan: The test procedure below shall be used to identify potential unwanted emissions of the UUT.

Step 1: The sensitivity of the spectrum analyzer should be such that the noise floor is at least 12 dB below the limits given in tables 4 or 12.

Step 2: The emissions over the range 30 MHz to 1 000 MHz shall be identified.

Spectrum analyzer settings :

- Resolution bandwidth : 100 kHz
- Video bandwidth : 300 kHz
- Detector mode : Peak
- Filter type : 3 dB (Gaussian)
- Trace Mode : Max Hold
- Sweep Points : $\geq 19\,400$

NOTE 1: For spectrum analyzers not supporting this high number of sweep points, the frequency band may need to be segmented.

- Sweep time:

- For non-continuous transmissions (duty cycle less than 100 %), the sweep time shall be sufficiently long, such that for each 100 kHz frequency step, the measurement time is greater than two transmissions of the UUT.
- For Frequency Hopping equipment operating in a normal operating (hopping not disabled) mode, the sweep time shall be further increased to capture multiple transmissions on the same hopping frequency in different hopping sequences.

Allow the trace to stabilize. Any emissions identified during the sweeps above and that fall within the 6 dB range below the applicable limit or above, shall be individually measured using the procedure in clause 5.4.9.2.1.3 and compared to the limits given in tables 4 or 12.

Step 3: The emissions over the range 1 GHz to 12,75 GHz shall be identified.

Spectrum analyzer settings:

- Resolution bandwidth : 1 MHz
- Video bandwidth : 3 MHz
- Filter type : 3 dB (Gaussian)
- Detector mode : Peak
- Trace Mode : Max Hold
- Sweep Points : $\geq 23\,500$

NOTE 2: For spectrum analyzers not supporting this high number of sweep points, the frequency band may need to be segmented.

- Sweep time:

- For non-continuous transmissions (duty cycle less than 100 %), the sweep time shall be sufficiently long, such that for each 1 MHz frequency step, the measurement time is greater than two transmissions of the UUT.
- For Frequency Hopping equipment operating in a normal operating (hopping not disabled)

mode, the sweep time shall be further increased to capture multiple transmissions on the same hopping frequency in different hopping sequences.

Allow the trace to stabilize. Any emissions identified during the sweeps above that fall within the 6 dB range below the applicable limit or above, shall be individually measured using the procedure in clause 5.4.9.2.1.3 and compared to the limits given in tables 4 or 12.

Frequency Hopping equipment may generate a block (or several blocks) of spurious emissions anywhere within the spurious domain. If this is the case, only the highest peak of each block of emissions shall be measured using the procedure in clause 5.4.9.2.1.3.

Step 4: In case of conducted measurements on smart antenna systems (equipment with multiple transmit

chains), the steps 2 and 3 need to be repeated for each of the active transmit chains (Ach). The limits used to identify emissions during this pre-scan need to be reduced with $10 \times \log_{10}(\text{Ach})$ (number of active transmit chains).

Measurement of the emissions identified during the pre-scan

Step 1: The level of the emissions shall be measured using the following spectrum analyzer settings:

- Measurement Mode : Time Domain Power
- Centre Frequency : Frequency of emission identified during the pre-scan
- Resolution Bandwidth : 100 kHz (< 1 GHz) / 1 MHz (> 1 GHz)
- Video Bandwidth : 300 kHz (< 1 GHz) / 3 MHz (> 1 GHz)
- Frequency Span : Zero Span
- Sweep mode : Single Sweep
- Sweep time : >120 % of the duration of the longest burst detected during the measurement of the RF Output Power
- Sweep points : Sweep time [μs] / (1 μs) with a maximum of 30 000
- Trigger : Video (burst signals) or Manual (continuous signals)
- Detector : RMS

Step 2: Set a window where the start and stop indicators match the start and end of the burst with the highest level and record the value of the power measured within this window.

If the spurious emission to be measured is a continuous transmission, the measurement window shall be set to match the start and stop times of the sweep.

Step 3: In case of conducted measurements on smart antenna systems (equipment with multiple transmit chains), step 2 needs to be repeated for each of the active transmit chains (Ach).

Sum the measured power (within the observed window) for each of the active transmit chains.

Step 4: The value defined in step 3 shall be compared to the limits defined in tables 4 or 12.

5.4.7.1 Measurement Record

Note: For test data, please refer to the appendix results.

Remark:

Table 1: Transmitter limits for spurious emissions

Frequency Range	Maximum Power e.r.p(<=1GHz)/e.i.r.p(>1GHz)	Bandwidth
30 MHz to 47 MHz	-36dBm	100kHz
47 MHz to 74 MHz	-54dBm	100kHz
74 MHz to 87.5 MHz	-36dBm	100kHz
87.5 MHz to 118 MHz	-54dBm	100kHz
118 MHz to 174 MHz	-36dBm	100kHz
174 MHz to 230 MHz	-54dBm	100kHz
230 MHz to 470 MHz	-36dBm	100kHz
470 MHz to 694 MHz	-54dBm	100kHz
694 MHz to 1GHz	-36dBm	100kHz
1 GHz to 12.75 GHz	-30dBm	1MHz

5.5 Receiver Requirements

5.5.1 Receiver Spurious Emissions

Test requirement: EN 300 328 clause 4.3.2.10

Test Method: EN 300 328 clause 5.4.10.2.2

EUT Operation:

Status: Enter test mode for the product, Test in Channel lowest (2402MHz) and highest (2480MHz), keep in continuously receiving status.

Test Setup:

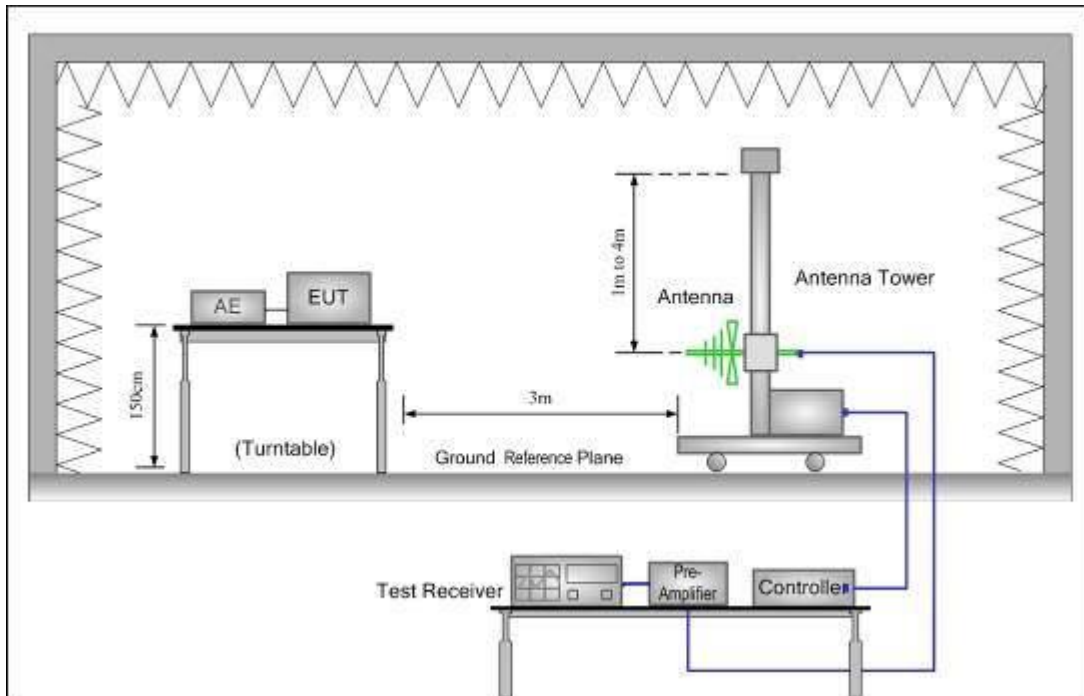

Figure 1. 30MHz to 1GHz

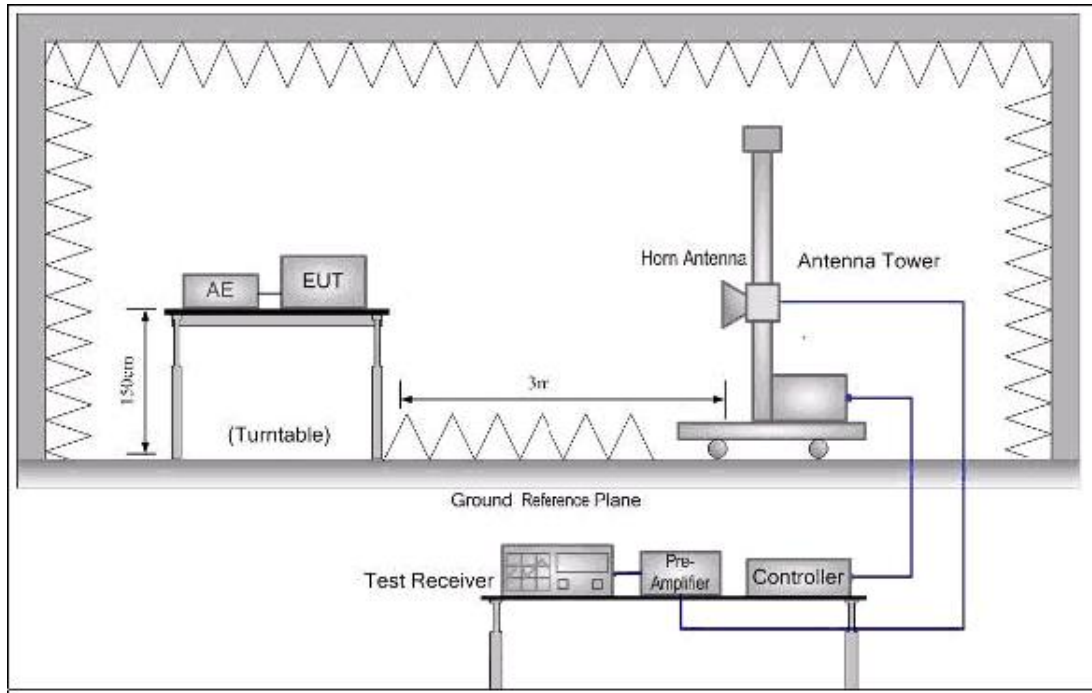

Figure 2. Above 1GHz

Test procedure:

Substitution method was performed to determine the actual spurious emission levels of the EUT. The following test procedure as below:

1) Below 1GHz test procedure:

1. On the test site as test setup graph above, the EUT shall be placed at the 1.5m support on the turntable and in the position closest to normal use as declared by the provider.
2. The test antenna shall be oriented initially for vertical polarization and shall be chosen to correspond to the test frequency of the transmitter. The output of the test antenna shall be connected to the measuring receiver.
3. The transmitter shall be switched on, if possible, without modulation and the measuring receiver shall be tuned to the test frequency of the transmitter under test.
4. The test antenna shall be raised and lowered from 1m to 4m until a maximum signal level is detected by the measuring receiver. Then the turntable should be rotated through 360° in the horizontal plane, until the maximum signal level is detected by the measuring receiver.
5. Repeat step 4 for test frequency with the test antenna polarized horizontally.

6. Remove the transmitter and replace it with a substitution antenna (the antenna should be half-wavelength for each frequency involved). The center of the substitution antenna should be approximately at the same location as the center of the transmitter. At the lower frequencies, where the substitution antenna is very long, this will be impossible to achieve when the antenna is polarized vertically. In such case the lower end of the antenna should be 0.3 m above the ground.
7. Feed the substitution antenna at the transmitter end with a signal generator connected to the antenna by means of a nonradiating cable. With the antennas at both ends vertically polarized, and with the signal generator tuned to a particular test frequency, raise and lower the test antenna to obtain a maximum reading at the spectrum analyzer. Adjust the level of the signal generator output until the previously recorded maximum reading for this set of conditions is obtained. This should be done carefully repeating the adjustment of the test antenna and generator output.
8. Repeat step 7 with both antennas horizontally polarized for each test frequency.
9. Calculate power in dBm into a reference ideal half-wave dipole antenna by reducing the readings obtained in steps 7 and 8 by the power loss in the cable between the generator and the antenna, and further corrected for the gain of the substitution antenna used relative to an ideal half-wave dipole antenna by the following formula:

$$\text{ERP(dBm)} = \text{Pg(dBm)} - \text{cable loss (dB)} + \text{antenna gain (dBd)}$$

where:

Pg is the generator output power into the substitution antenna.

- 2) above 1GHz test procedure:

1. Different between above is the test site, change from Semi- Anechoic Chamber to fully Anechoic Chamber, and the test antenna do not need to raise from 1 to 4m, just test in 1.5m height.

5.5.1.1 Measurement Record

Note: For test data, please refer to the appendix results.

Remark:

Table 2: Spurious emission limits for receivers

Frequency range	Maximum power e.r.p.(≤ 1 GHz) e.i.r.p(>1 GHz)	Measurement bandwidth
30 MHz to 1 GHz	-57 dBm	100 KHz
1 GHz to 12,75 GHz	-47 dBm	1 MHz

-70dBm or -120dBm/Hz is the minimum level can be detected by measuring receiver when below 1GHz,
-60dBm or -110dBm/Hz at over 1GHz.

5.6 Adaptivity

Test Requirement:	EN 300 328 Clause 4.3.2.6
Test Method:	EN 300 328 Clause 5.4.6
EUT Operation:	
Ambient:	Temp.: 26 °C Humid.: 52 % Press.: 1010 mbar
Test Status:	1) Keep the EUT operating at the lowest and the highest frequency. The measurement shall be performed during normal operation 2) Test EUT in normal conditions.
Equipment Used:	Refer to section 5 for details.
Test Setup:	

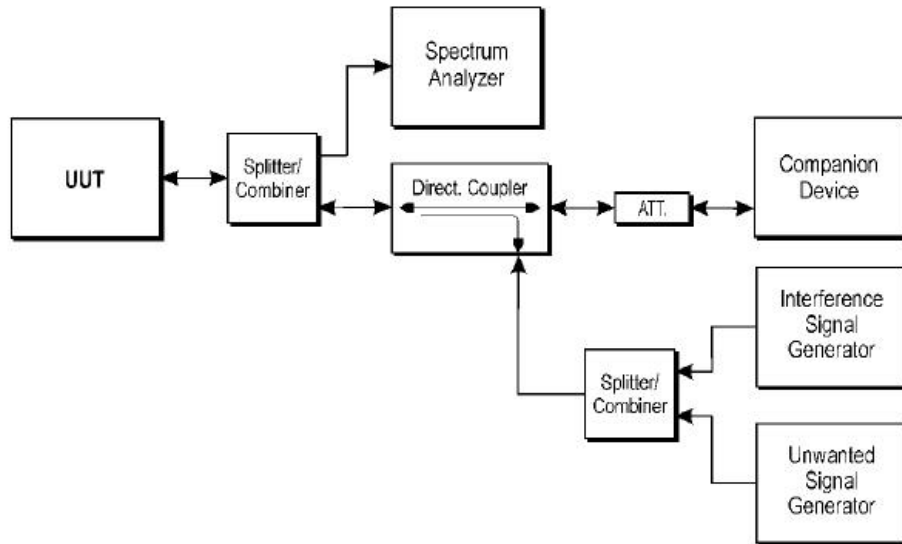

Figure 5: Test set-up for verifying the adaptivity of an equipment

5.6.1.1 Measurement Record

N/A: not applicable.

Refer to the EN 300 328 clause 4.3.2.6 section for the details.

This requirement does not apply to non-adaptive equipment or adaptive equipment operating in a non-adaptive mode providing the equipment complies with the requirements and/or restrictions applicable to non-adaptive equipment.

In addition, this requirement does not apply for equipment with a maximum declared RF Output power level of less than 10 dBm e.i.r.p. or for equipment when operating in a mode where the RF Output power is less than 10 dBm e.i.r.p.

As the EUT about RF Output power level is less than 10 dBm e.i.r.p, so the test is not applicable and skipped.

5.7 Receiver Blocking

5.7.1 Performance Criteria

The minimum performance criterion shall be a PER less than or equal to 10 %. The manufacturer may declare alternative performance criteria as long as that is appropriate for the intended use of the equipment (see clause 5.4.1.t)).

5.7.2 Limit(ETSI EN 300 328 V2.2.2 (2019-07) Clause 4.3.2.11.4)

While maintaining the minimum performance criteria as defined in clause 4.3.1.12.3, the blocking levels at specified frequency offsets shall be equal to or greater than the limits defined for the applicable receiver category provided in table 6, table 7 or table 8.

Receiver Category 1

Table 6: Receiver Blocking parameters for Receiver Category 1 equipment

Wanted signal mean power from companion device (dBm) (see notes 1 and 4)	Blocking signal frequency (MHz)	Blocking signal power (dBm) (see note 4)	Type of blocking signal
(-133 dBm + 10 × log ₁₀ (OCBW)) or -68 dBm whichever is less (see note 2)	2 380	-34	CW
	2 504		
(-139 dBm + 10 × log ₁₀ (OCBW)) or -74 dBm whichever is less (see note 3)	2 300		
	2 330		
	2 360		
	2 524		
	2 584		
	2 674		

NOTE 1: OCBW is in Hz.
 NOTE 2: In case of radiated measurements using a companion device and the level of the wanted signal from the companion device cannot be determined, a relative test may be performed using a wanted signal up to P_{min} + 26 dB where P_{min} is the minimum level of wanted signal required to meet the minimum performance criteria as defined in clause 4.3.1.12.3 in the absence of any blocking signal.
 NOTE 3: In case of radiated measurements using a companion device and the level of the wanted signal from the companion device cannot be determined, a relative test may be performed using a wanted signal up to P_{min} + 20 dB where P_{min} is the minimum level of wanted signal required to meet the minimum performance criteria as defined in clause 4.3.1.12.3 in the absence of any blocking signal.
 NOTE 4: The level specified is the level at the UUT receiver input assuming a 0 dBi antenna assembly gain. In case of conducted measurements, this level has to be corrected for the (in-band) antenna assembly gain (G). In case of radiated measurements, this level is equivalent to a power flux density (PFD) in front of the UUT antenna with the UUT being configured/positioned as recorded in clause 5.4.3.2.2.

Receiver Category 2

Table 7: Receiver Blocking parameters receiver Category 2 equipment

Wanted signal mean power from companion device (dBm) (see notes 1 and 3)	Blocking signal frequency (MHz)	Blocking signal power (dBm) (see note 3)	Type of blocking signal
(-139 dBm + 10 × log ₁₀ (OCBW) + 10 dB) or (-74 dBm + 10 dB) whichever is less (see note 2)	2 380	-34	CW
	2 504		
	2 300		
	2 584		
<p>NOTE 1: OCBW is in Hz. NOTE 2: In case of radiated measurements using a companion device and the level of the wanted signal from the companion device cannot be determined, a relative test may be performed using a wanted signal up to P_{min} + 26 dB where P_{min} is the minimum level of wanted signal required to meet the minimum performance criteria as defined in clause 4.3.1.12.3 in the absence of any blocking signal. NOTE 3: The level specified is the level at the UUT receiver input assuming a 0 dBi antenna assembly gain. In case of conducted measurements, this level has to be corrected for the (in-band) antenna assembly gain (G). In case of radiated measurements, this level is equivalent to a power flux density (PFD) in front of the UUT antenna with the UUT being configured/positioned as recorded in clause 5.4.3.2.2.</p>			

Receiver Category 3

Table 8: Receiver Blocking parameters receiver Category 3 equipment

Wanted signal mean power from companion device (dBm) (see notes 1 and 3)	Blocking signal frequency (MHz)	Blocking signal power (dBm) (see note 3)	Type of blocking Signal
(-139 dBm + 10 × log ₁₀ (OCBW) + 20 dB) or (-74 dBm + 20 dB) whichever is less (see note 2)	2 380	-34	CW
	2 504		
	2 300		
	2 584		
<p>NOTE 1: OCBW is in Hz. NOTE 2: In case of radiated measurements using a companion device and the level of the wanted signal from the companion device cannot be determined, a relative the test may be performed using a wanted signal up to P_{min} + 30 dB where P_{min} is the minimum level of wanted signal required to meet the minimum performance criteria as defined in clause 4.3.1.12.3 in the absence of any blocking signal. NOTE 3: The level specified is the level at the UUT receiver input assuming a 0 dBi antenna assembly gain. In case of conducted measurements, this level has to be corrected for the (in-band) antenna assembly gain (G). In case of radiated measurements, this level is equivalent to a power flux density (PFD) in front of the UUT antenna with the UUT being configured/positioned as recorded in clause 5.4.3.2.2.</p>			

5.7.3 Test procedure

Refer to ETSI EN 300 328 V2.2.2 (2019-07) Clause 5.4.11.2

Measurement	
<input checked="" type="checkbox"/> Conducted measurement	<input type="checkbox"/> Radiated measurement

5.7.4 Test Setup

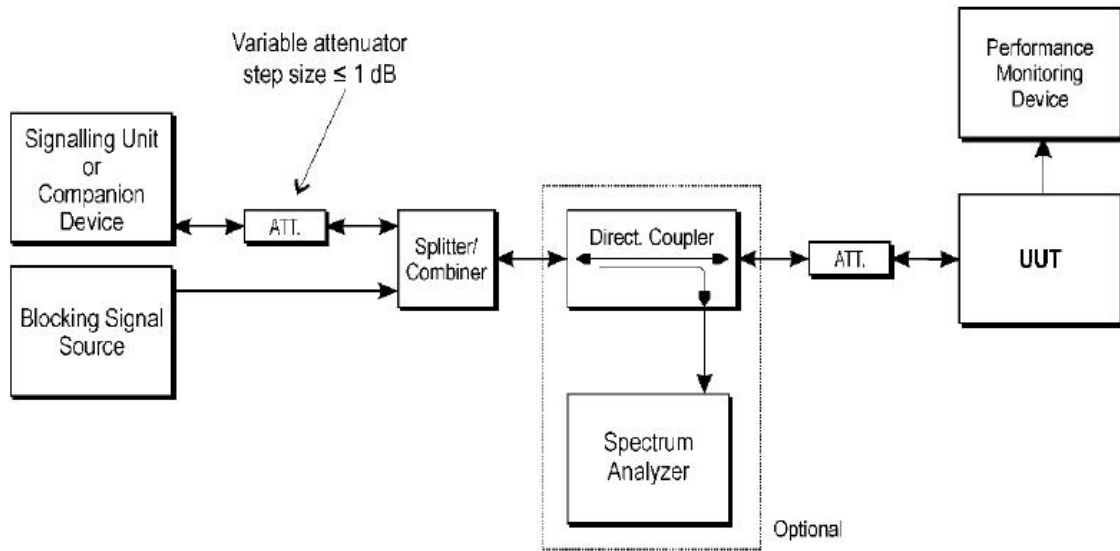

5.7.5 Test result

Note:

- 1.The power less than 10dBm, belong to category 2.
- 2.For test data, please refer to the appendix results.

6 Appendix test data

Appendix A. RF Output Power (E.I.R.P.)

Measurement Data:

Test Data of RF Output Power					
Test Mode	RF Output Power [dBm]			Limit [dBm]	Verdict
	NT	LT	HT		
LE1M_TX_2402_1Mbps	-1.21	-1.08	-1.33	20	Pass
LE1M_TX_2440_1Mbps	-0.09	-0.08	-0.09	20	Pass
LE1M_TX_2480_1Mbps	-1.56	-1.40	-1.71	20	Pass
LE2M_TX_2402_1Mbps	-1.16	-1.04	-1.27	20	Pass
LE2M_TX_2440_1Mbps	-0.11	-0.09	-0.12	20	Pass
LE2M_TX_2480_1Mbps	-1.09	-0.98	-1.19	20	Pass

Appendix B. Power Spectral Density

Measurement Data:

Test Data of Power Spectral Density			
Test Mode	Power Spectral Density [dBm/MHz]	Limit [dBm/MHz]	Verdict
LE1M_TX_2402_1Mbps	-1.27	10	Pass
LE1M_TX_2440_1Mbps	-0.15	10	Pass
LE1M_TX_2480_1Mbps	-1.62	10	Pass
LE2M_TX_2402_1Mbps	-2.35	10	Pass
LE2M_TX_2440_1Mbps	-1.29	10	Pass
LE2M_TX_2480_1Mbps	-1.15	10	Pass

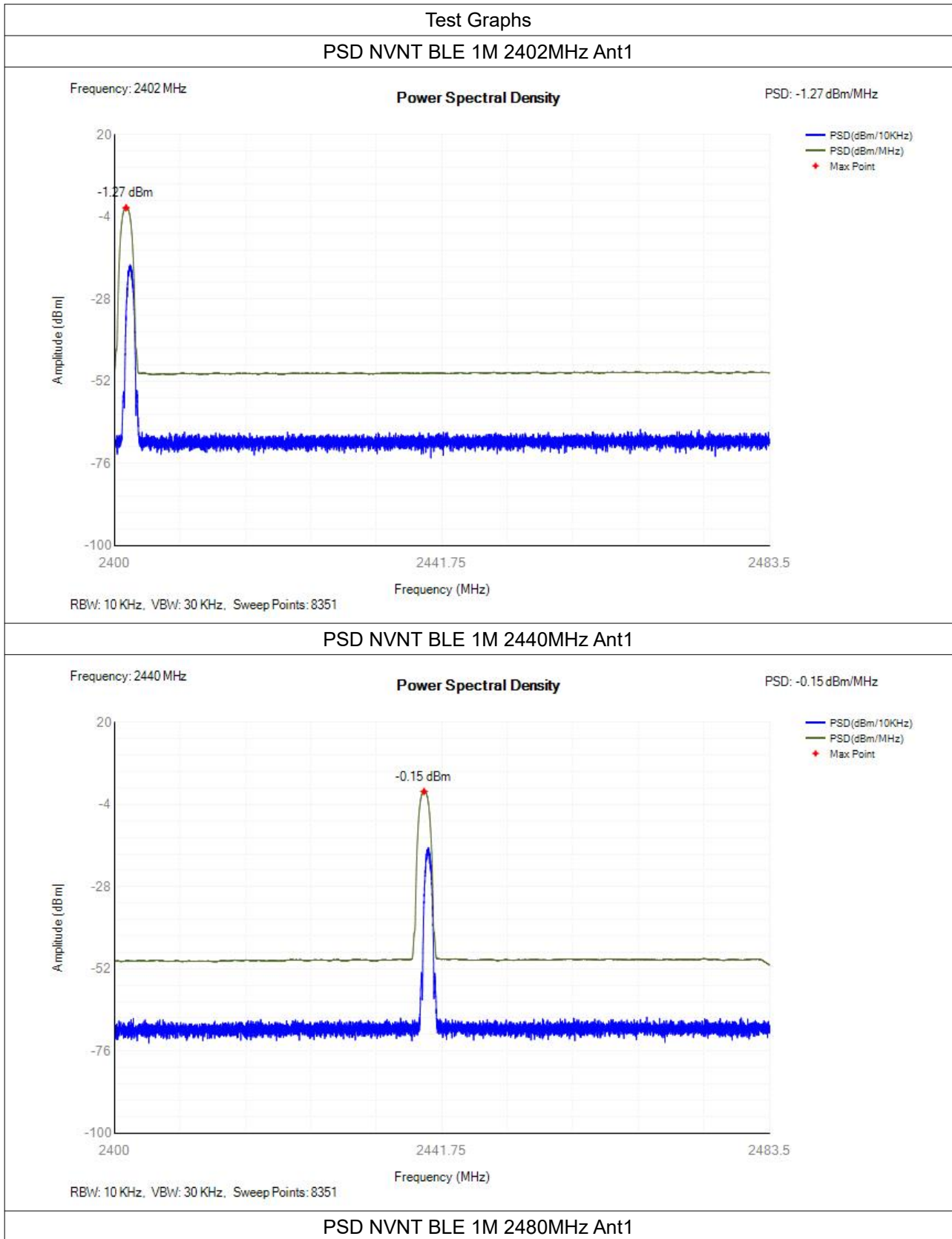

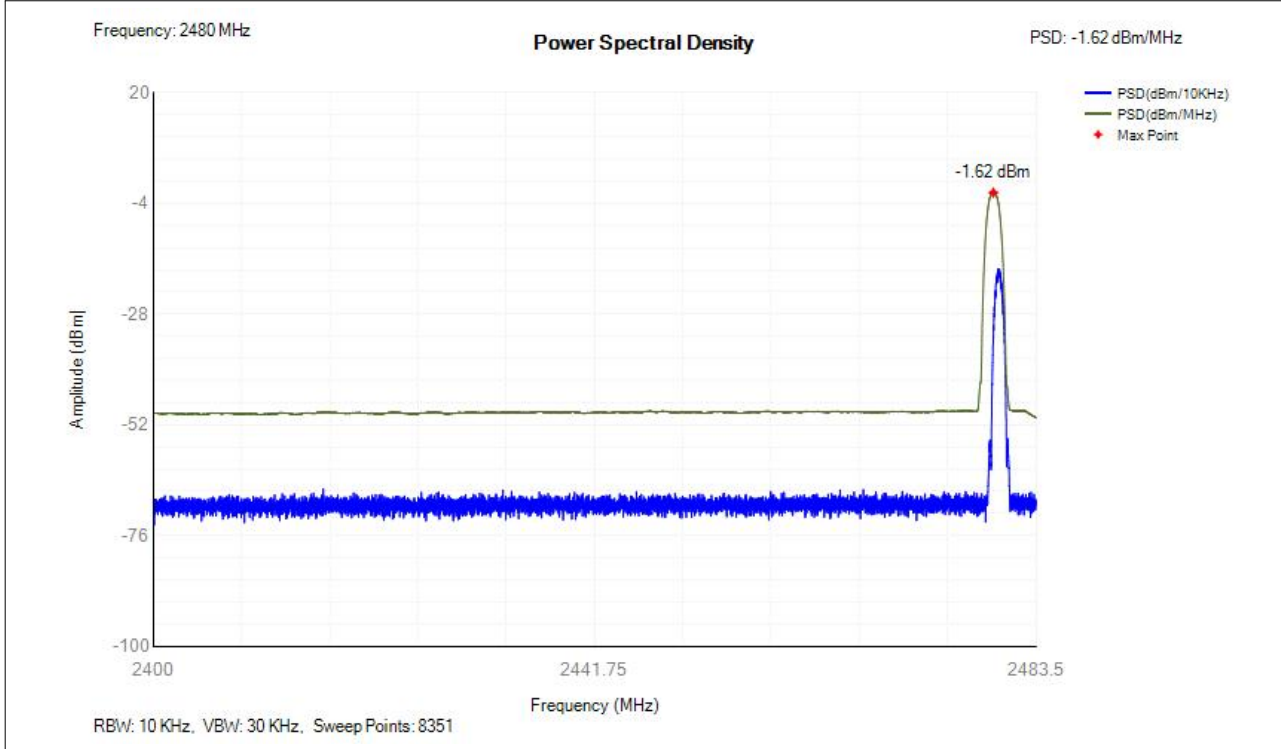

PSD NVNT BLE 2M 2402MHz Ant1

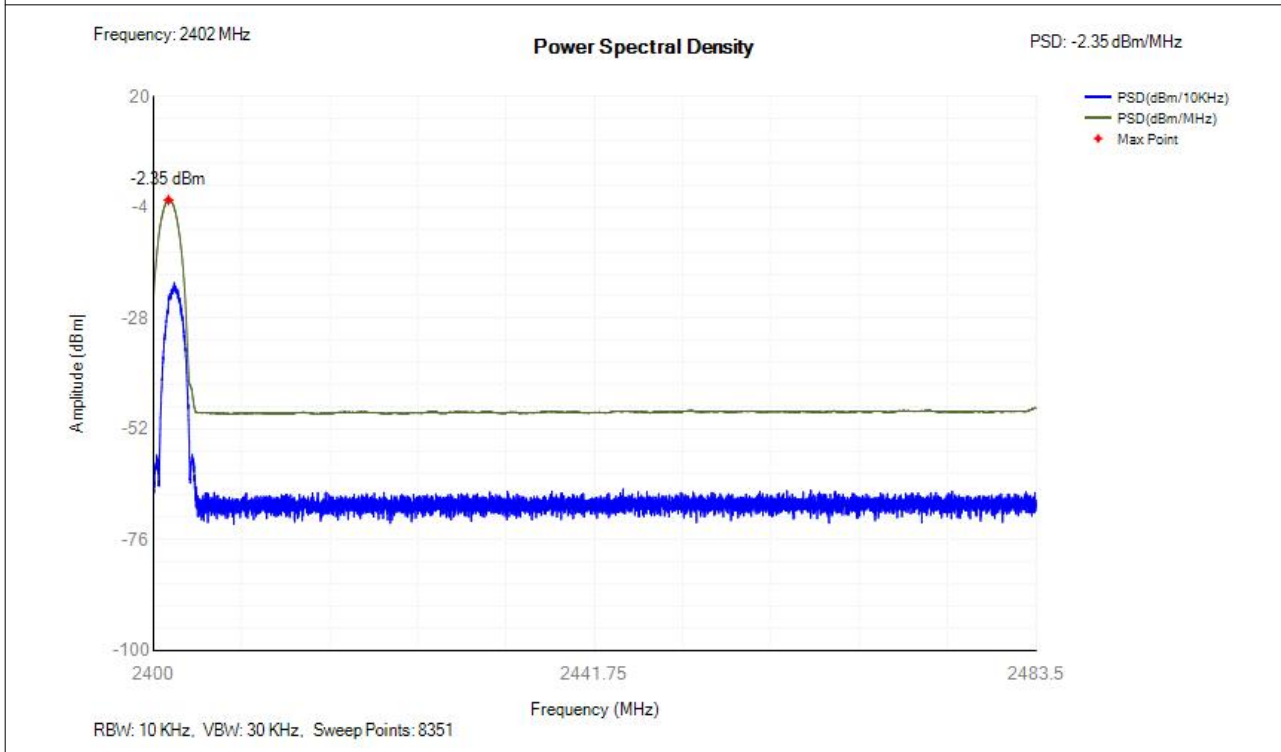

PSD NVNT BLE 2M 2440MHz Ant1

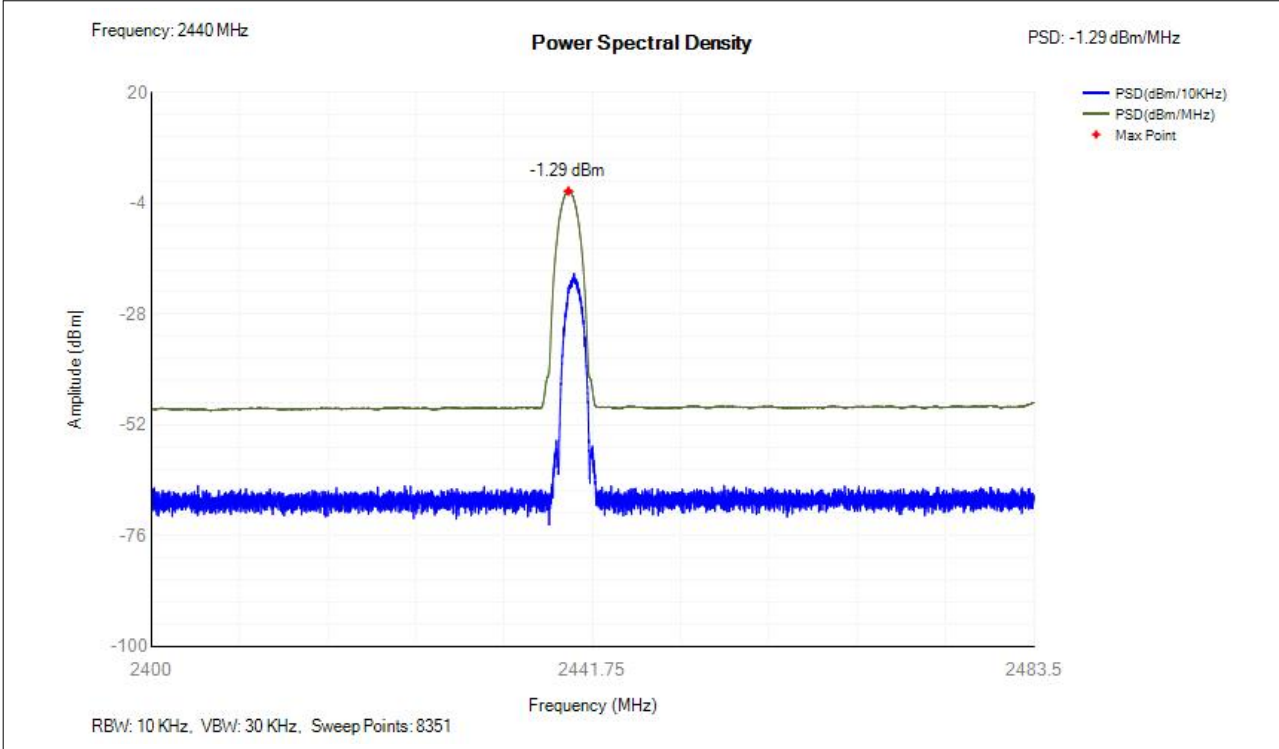

PSD NVNT BLE 2M 2480MHz Ant1

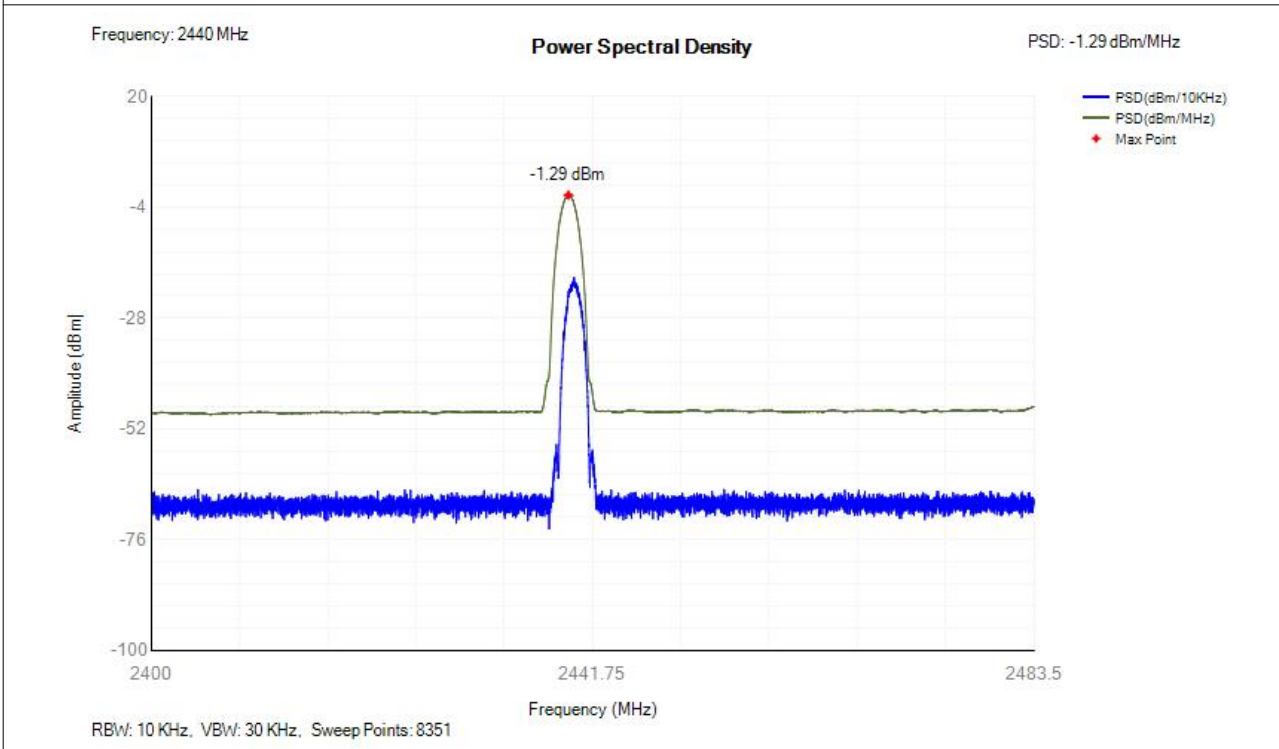

Appendix C. Occupied Channel Bandwidth

Measurement Data:

Test Data of Occupied Channel Bandwidth					
Test Mode	Occupied Channel Bandwidth [MHz]			Limit [MHz]	Verdict
	OCB	FL	FH		
LE1M_TX_2402_1Mbps	1.013	2401.494	2402.507	2400 to 2483.5	Pass
LE1M_TX_2480_1Mbps	1.013	2479.493	2480.505	2400 to 2483.5	Pass
LE2M_TX_2402_1Mbps	2.026	2400.992	2403.018	2400 to 2483.5	Pass
LE2M_TX_2480_1Mbps	2.088	2478.984	2481.034	2400 to 2483.5	Pass

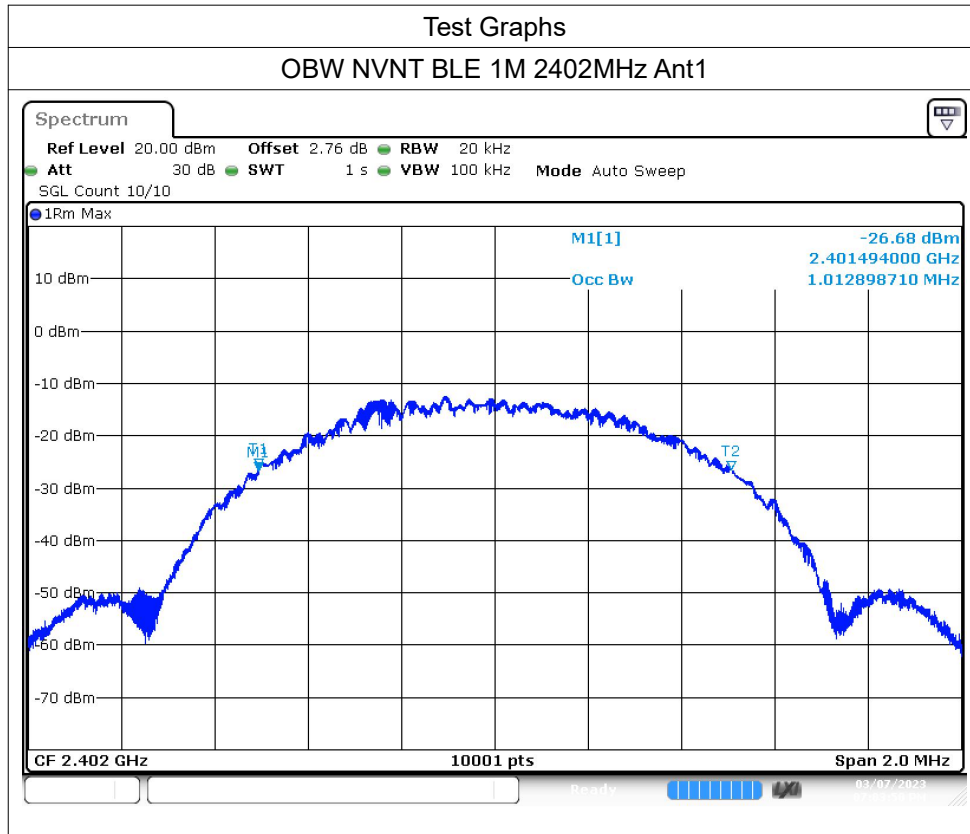

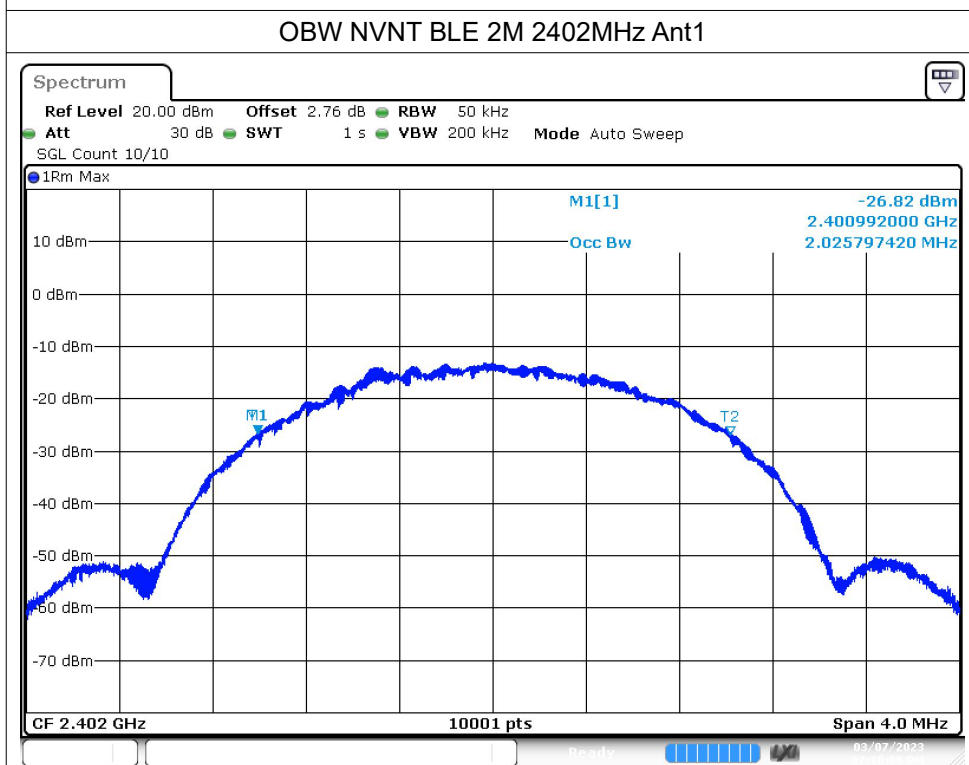
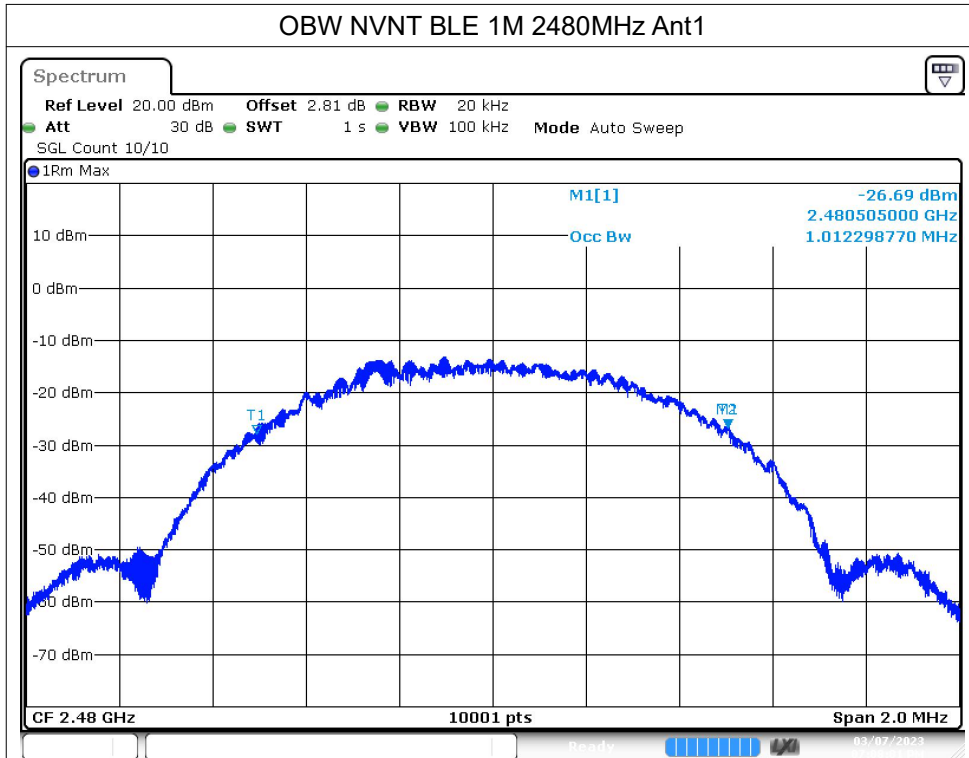

OBW NVNT BLE 2M 2480MHz Ant1

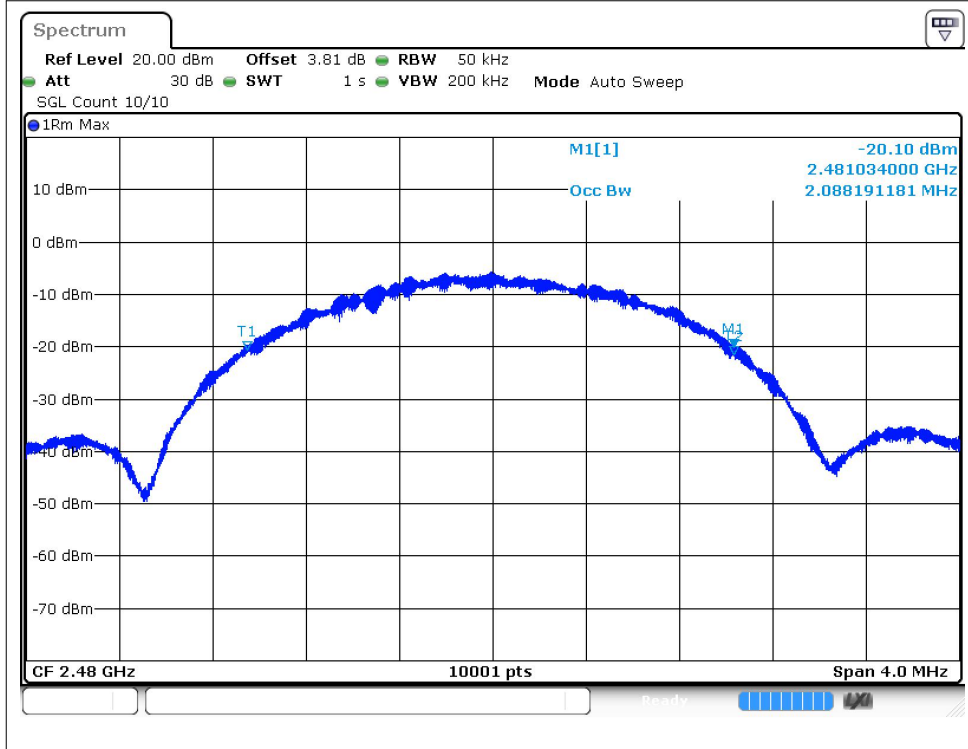

Appendix D. Transmitter unwanted emissions in the OOB domain

Measurement Data:

Mode	Frequency (MHz)	Antenna	OOB Frequency (MHz)	Level (dBm/MHz)	Limit (dBm/MHz)	Verdict
BLE 1M	2402	Ant1	2399.5	-55.74	-10	Pass
BLE 1M	2402	Ant1	2399.487	-55.39	-10	Pass
BLE 1M	2402	Ant1	2398.487	-56.03	-20	Pass
BLE 1M	2402	Ant1	2398.474	-55.98	-20	Pass
BLE 1M	2402	Ant1	2484	-57.39	-10	Pass
BLE 1M	2402	Ant1	2485	-57.38	-20	Pass
BLE 1M	2440	Ant1	2399.5	-58.07	-10	Pass
BLE 1M	2440	Ant1	2398.5	-57.77	-20	Pass
BLE 1M	2440	Ant1	2484	-57.32	-10	Pass
BLE 1M	2440	Ant1	2485	-57.32	-20	Pass
BLE 1M	2480	Ant1	2399.5	-58.09	-10	Pass
BLE 1M	2480	Ant1	2398.5	-57.79	-20	Pass
BLE 1M	2480	Ant1	2484	-51.99	-10	Pass
BLE 1M	2480	Ant1	2484.012	-52.1	-10	Pass
BLE 1M	2480	Ant1	2485.012	-53.18	-20	Pass
BLE 1M	2480	Ant1	2485.024	-53.43	-20	Pass
BLE 2M	2402	Ant1	2399.5	-46.51	-10	Pass
BLE 2M	2402	Ant1	2398.5	-48.24	-10	Pass
BLE 2M	2402	Ant1	2398.474	-48.24	-10	Pass
BLE 2M	2402	Ant1	2397.474	-48.22	-20	Pass
BLE 2M	2402	Ant1	2396.474	-50.64	-20	Pass
BLE 2M	2402	Ant1	2396.448	-50.59	-20	Pass
BLE 2M	2402	Ant1	2484	-57.01	-10	Pass
BLE 2M	2402	Ant1	2485	-57.01	-20	Pass
BLE 2M	2440	Ant1	2399.5	-57.67	-10	Pass
BLE 2M	2440	Ant1	2398.5	-57.4	-20	Pass
BLE 2M	2440	Ant1	2484	-56.96	-10	Pass
BLE 2M	2440	Ant1	2485	-56.96	-20	Pass
BLE 2M	2480	Ant1	2399.5	-58.11	-10	Pass
BLE 2M	2480	Ant1	2398.5	-57.8	-20	Pass
BLE 2M	2480	Ant1	2484	-51.98	-10	Pass
BLE 2M	2480	Ant1	2484.024	-51.75	-10	Pass
BLE 2M	2480	Ant1	2485.024	-53.43	-10	Pass
BLE 2M	2480	Ant1	2485.048	-53.33	-20	Pass
BLE 2M	2480	Ant1	2399.5	-55.74	-20	Pass
BLE 2M	2480	Ant1	2399.487	-55.39	-20	Pass

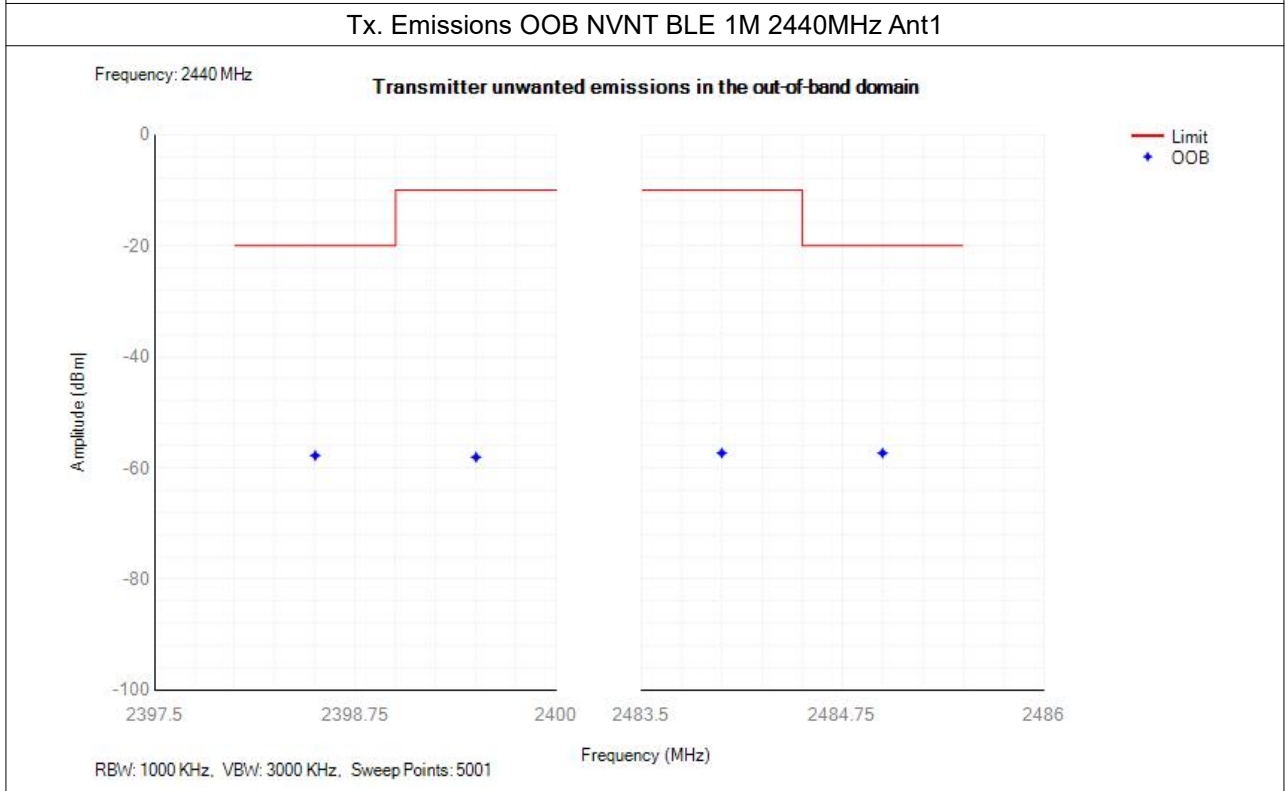
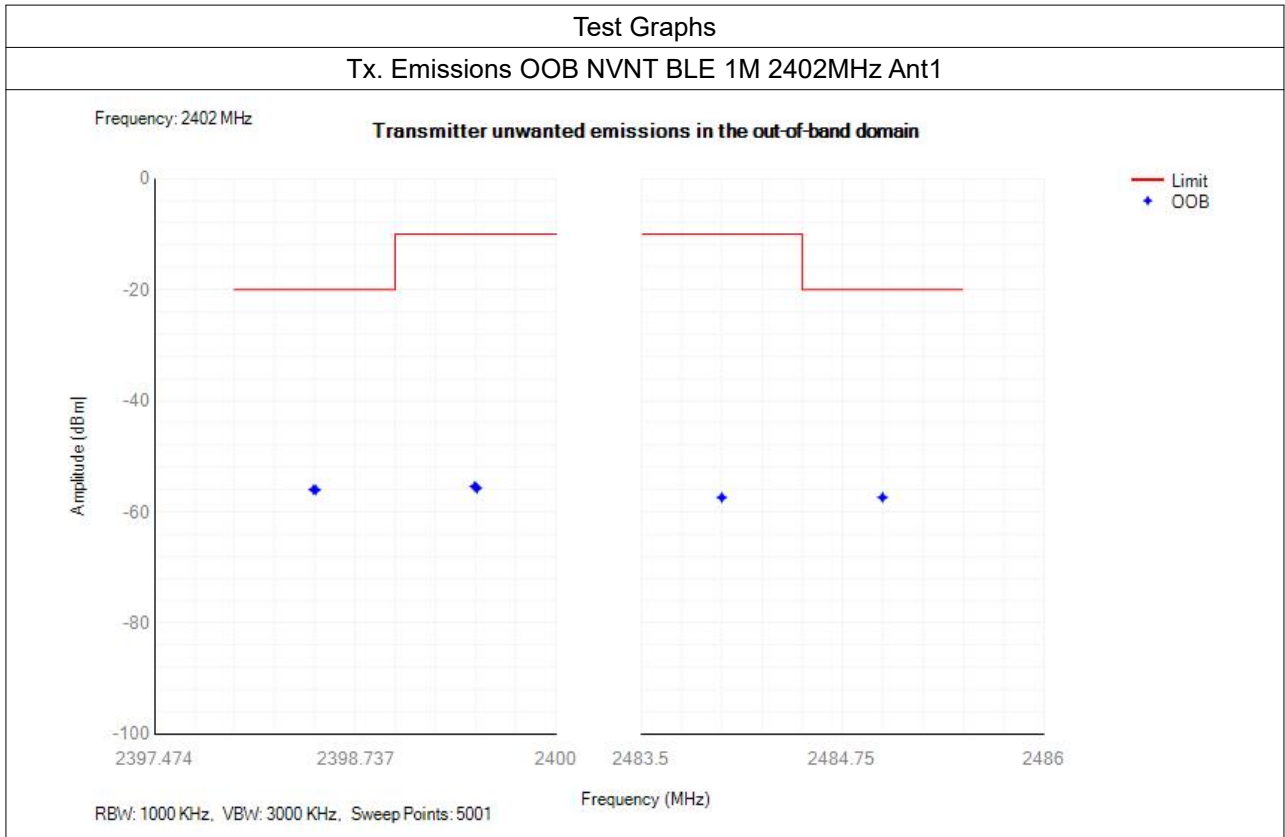

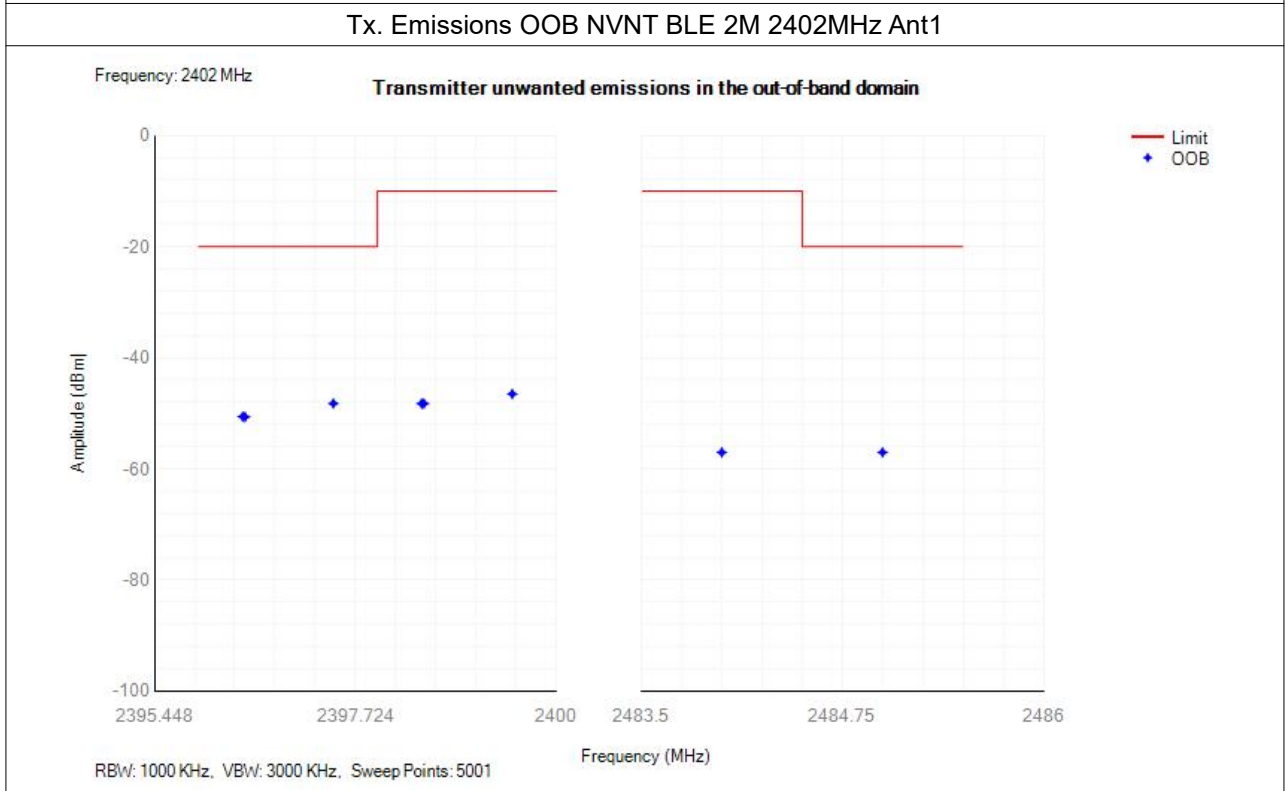
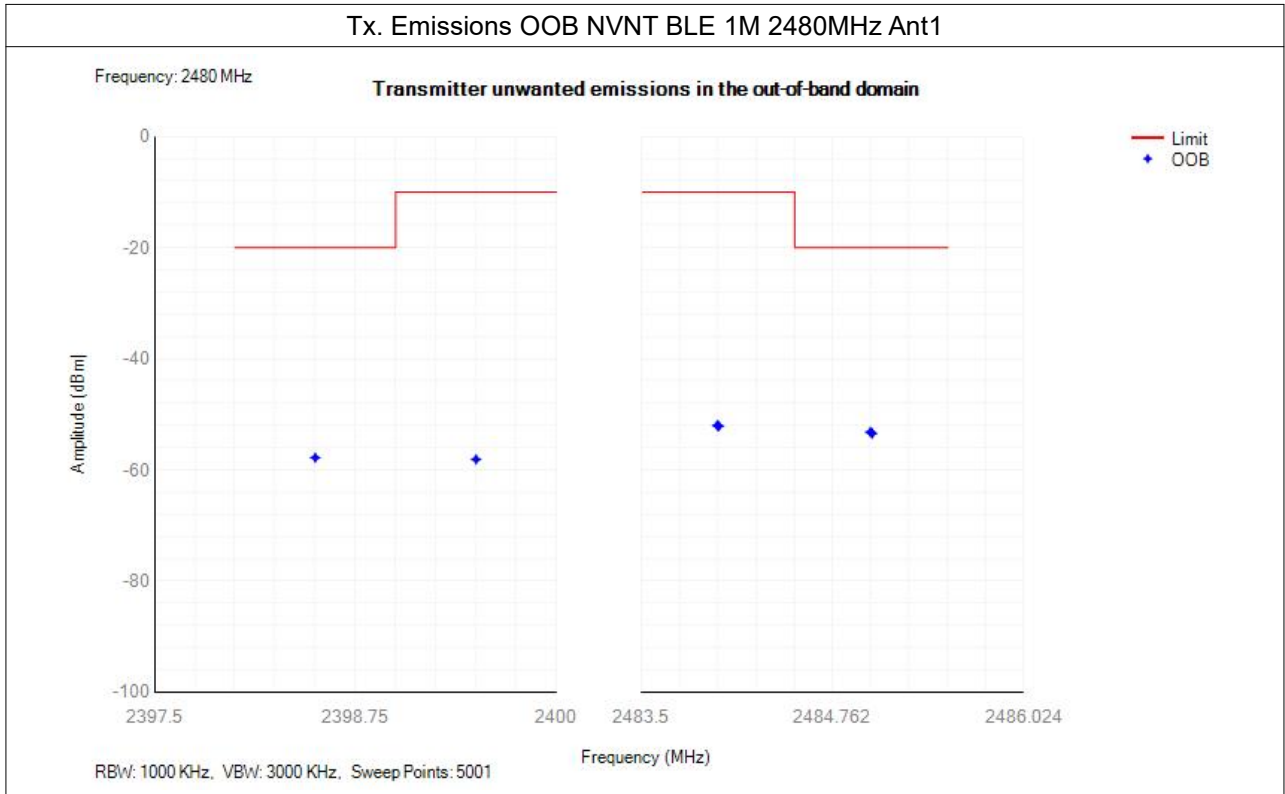

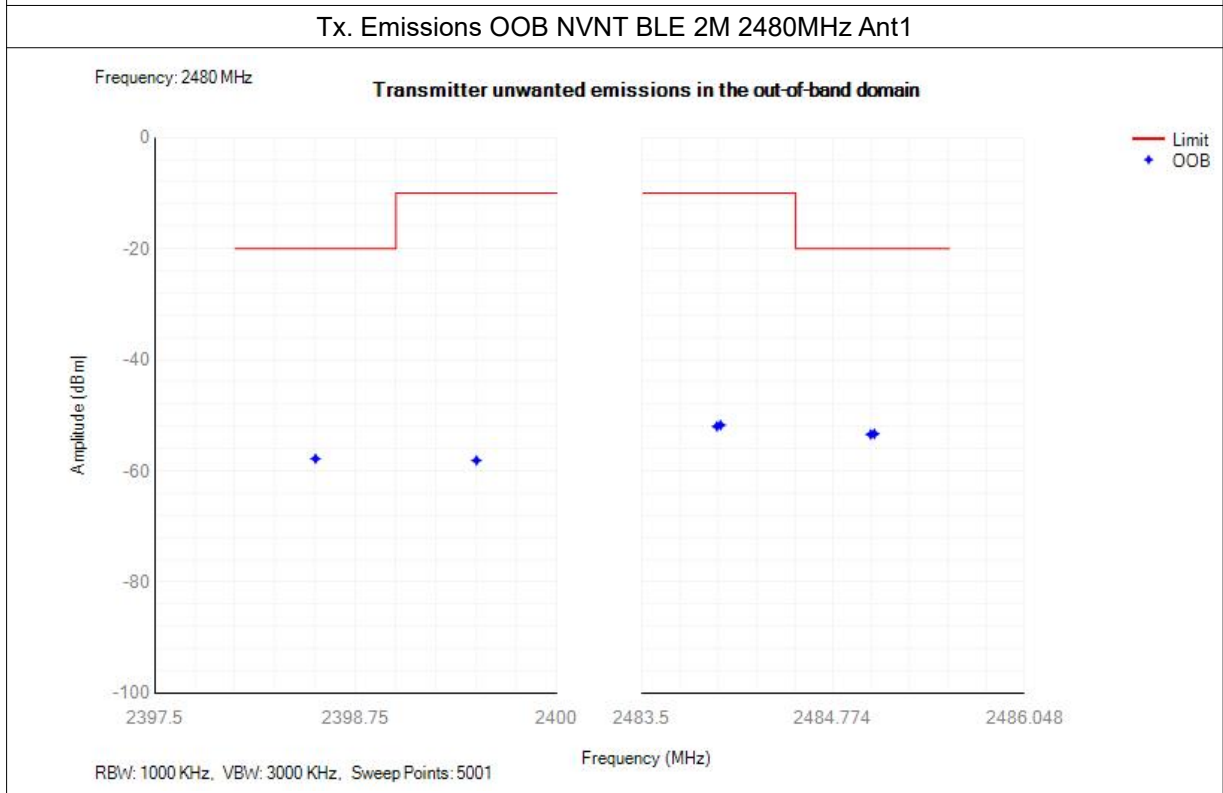
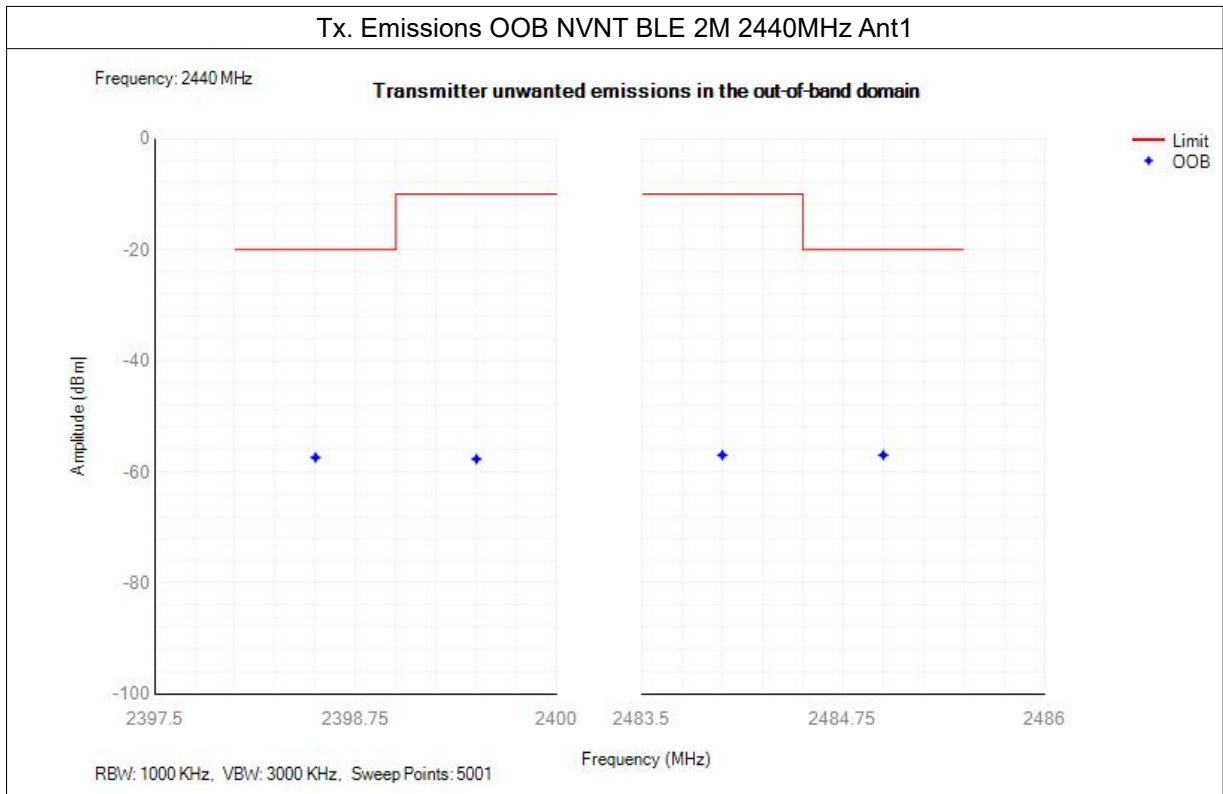

Appendix E. Transmitter unwanted emissions in the spurious domain

Measurement Data:

Conducted Method:

Mode	Frequency (MHz)	Antenna	Range (MHz)	Spur Freq (MHz)	Peak (dBm)	Limit (dBm)	Verdict
BLE 1M	2402	Ant1	30 -47	32.85	-79.45	-36	Pass
BLE 1M	2402	Ant1	47 -74	50.80	-79.59	-54	Pass
BLE 1M	2402	Ant1	74 -87.5	76.30	-79.35	-36	Pass
BLE 1M	2402	Ant1	87.5 -118	102.95	-78.41	-54	Pass
BLE 1M	2402	Ant1	118 -174	147.80	-78.31	-36	Pass
BLE 1M	2402	Ant1	174 -230	207.40	-78.76	-54	Pass
BLE 1M	2402	Ant1	230 -470	241.60	-77.59	-36	Pass
BLE 1M	2402	Ant1	470 -694	641.30	-77.61	-54	Pass
BLE 1M	2402	Ant1	694 -1000	761.45	-73.40	-36	Pass
BLE 1M	2402	Ant1	1000 -2398	2395.50	-51.41	-30	Pass
BLE 1M	2402	Ant1	2485.5 -12750	12629.00	-46.13	-30	Pass
BLE 1M	2440	Ant1	30 -47	43.60	-79.99	-36	Pass
BLE 1M	2440	Ant1	47 -74	58.35	-79.03	-54	Pass
BLE 1M	2440	Ant1	74 -87.5	76.35	-78.07	-36	Pass
BLE 1M	2440	Ant1	87.5 -118	112.30	-78.88	-54	Pass
BLE 1M	2440	Ant1	118 -174	120.65	-78.53	-36	Pass
BLE 1M	2440	Ant1	174 -230	202.30	-78.09	-54	Pass
BLE 1M	2440	Ant1	230 -470	245.85	-77.83	-36	Pass
BLE 1M	2440	Ant1	470 -694	559.70	-77.47	-54	Pass
BLE 1M	2440	Ant1	694 -1000	762.35	-74.50	-36	Pass
BLE 1M	2440	Ant1	1000 -2398	2134.00	-55.80	-30	Pass
BLE 1M	2440	Ant1	2485.5 -12750	10587.50	-46.46	-30	Pass
BLE 1M	2480	Ant1	30 -47	37.80	-79.56	-36	Pass
BLE 1M	2480	Ant1	47 -74	56.05	-79.29	-54	Pass
BLE 1M	2480	Ant1	74 -87.5	77.10	-78.91	-36	Pass
BLE 1M	2480	Ant1	87.5 -118	89.50	-78.32	-54	Pass
BLE 1M	2480	Ant1	118 -174	156.30	-78.32	-36	Pass
BLE 1M	2480	Ant1	174 -230	204.70	-78.40	-54	Pass
BLE 1M	2480	Ant1	230 -470	425.45	-77.52	-36	Pass
BLE 1M	2480	Ant1	470 -694	600.00	-77.56	-54	Pass
BLE 1M	2480	Ant1	694 -1000	761.20	-71.25	-36	Pass
BLE 1M	2480	Ant1	1000 -2398	2314.50	-55.57	-30	Pass
BLE 1M	2480	Ant1	2485.5 -12750	12226.50	-46.46	-30	Pass
BLE 2M	2402	Ant1	30 -47	44.70	-79.00	-36	Pass
BLE 2M	2402	Ant1	47 -74	58.35	-79.48	-54	Pass
BLE 2M	2402	Ant1	74 -87.5	87.30	-79.58	-36	Pass
BLE 2M	2402	Ant1	87.5 -118	110.50	-78.89	-54	Pass
BLE 2M	2402	Ant1	118 -174	147.70	-78.84	-36	Pass
BLE 2M	2402	Ant1	174 -230	217.50	-78.48	-54	Pass



BLE 2M	2402	Ant1	230 -470	411.00	-76.83	-36	Pass
BLE 2M	2402	Ant1	470 -694	627.70	-76.78	-54	Pass
BLE 2M	2402	Ant1	694 -1000	762.40	-74.05	-36	Pass
BLE 2M	2402	Ant1	1000 -2396	2395.00	-50.44	-30	Pass
BLE 2M	2402	Ant1	2487.5 -12750	6933.00	-46.28	-30	Pass
BLE 2M	2440	Ant1	30 -47	35.70	-79.91	-36	Pass
BLE 2M	2440	Ant1	47 -74	67.85	-78.93	-54	Pass
BLE 2M	2440	Ant1	74 -87.5	80.90	-79.48	-36	Pass
BLE 2M	2440	Ant1	87.5 -118	91.05	-78.55	-54	Pass
BLE 2M	2440	Ant1	118 -174	155.10	-78.25	-36	Pass
BLE 2M	2440	Ant1	174 -230	180.25	-78.34	-54	Pass
BLE 2M	2440	Ant1	230 -470	272.25	-77.35	-36	Pass
BLE 2M	2440	Ant1	470 -694	525.25	-77.83	-54	Pass
BLE 2M	2440	Ant1	694 -1000	761.85	-72.49	-36	Pass
BLE 2M	2440	Ant1	1000 -2396	1748.50	-43.14	-30	Pass
BLE 2M	2440	Ant1	2487.5 -12750	10600.00	-46.28	-30	Pass
BLE 2M	2480	Ant1	30 -47	42.85	-79.10	-36	Pass
BLE 2M	2480	Ant1	47 -74	48.85	-78.88	-54	Pass
BLE 2M	2480	Ant1	74 -87.5	75.30	-79.16	-36	Pass
BLE 2M	2480	Ant1	87.5 -118	112.35	-78.28	-54	Pass
BLE 2M	2480	Ant1	118 -174	164.25	-78.90	-36	Pass
BLE 2M	2480	Ant1	174 -230	199.25	-78.03	-54	Pass
BLE 2M	2480	Ant1	230 -470	338.50	-77.85	-36	Pass
BLE 2M	2480	Ant1	470 -694	600.00	-77.06	-54	Pass
BLE 2M	2480	Ant1	694 -1000	953.60	-75.54	-36	Pass
BLE 2M	2480	Ant1	1000 -2396	1763.00	-48.55	-30	Pass
BLE 2M	2480	Ant1	2487.5 -12750	6989.00	-46.35	-30	Pass

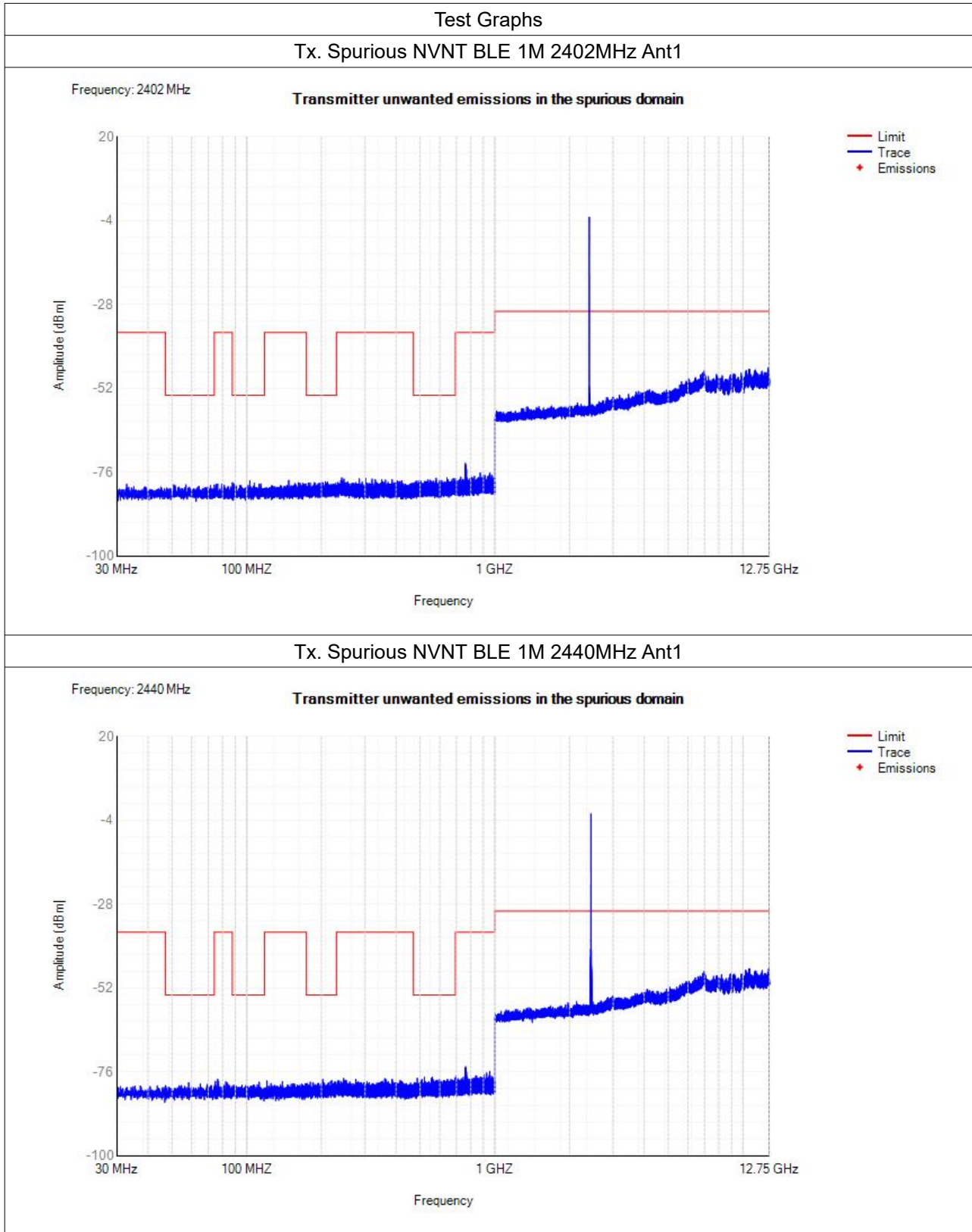

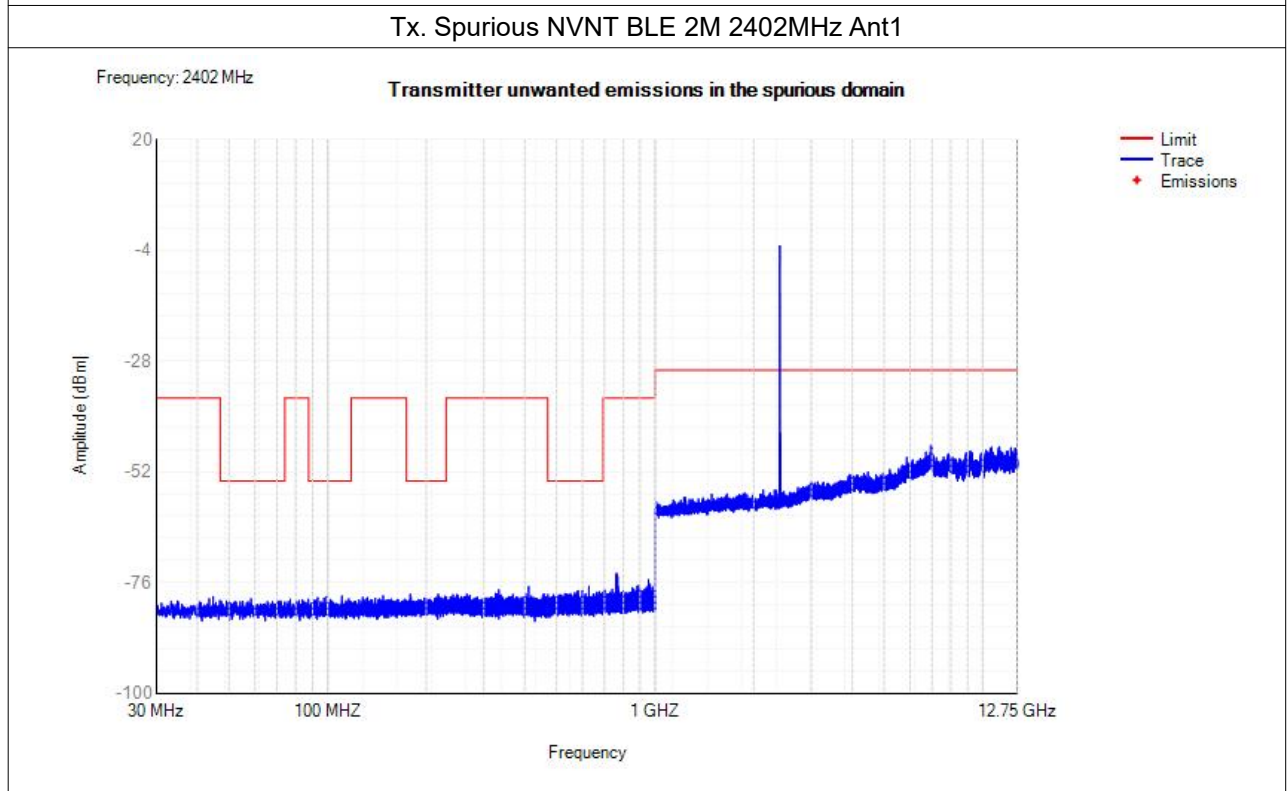
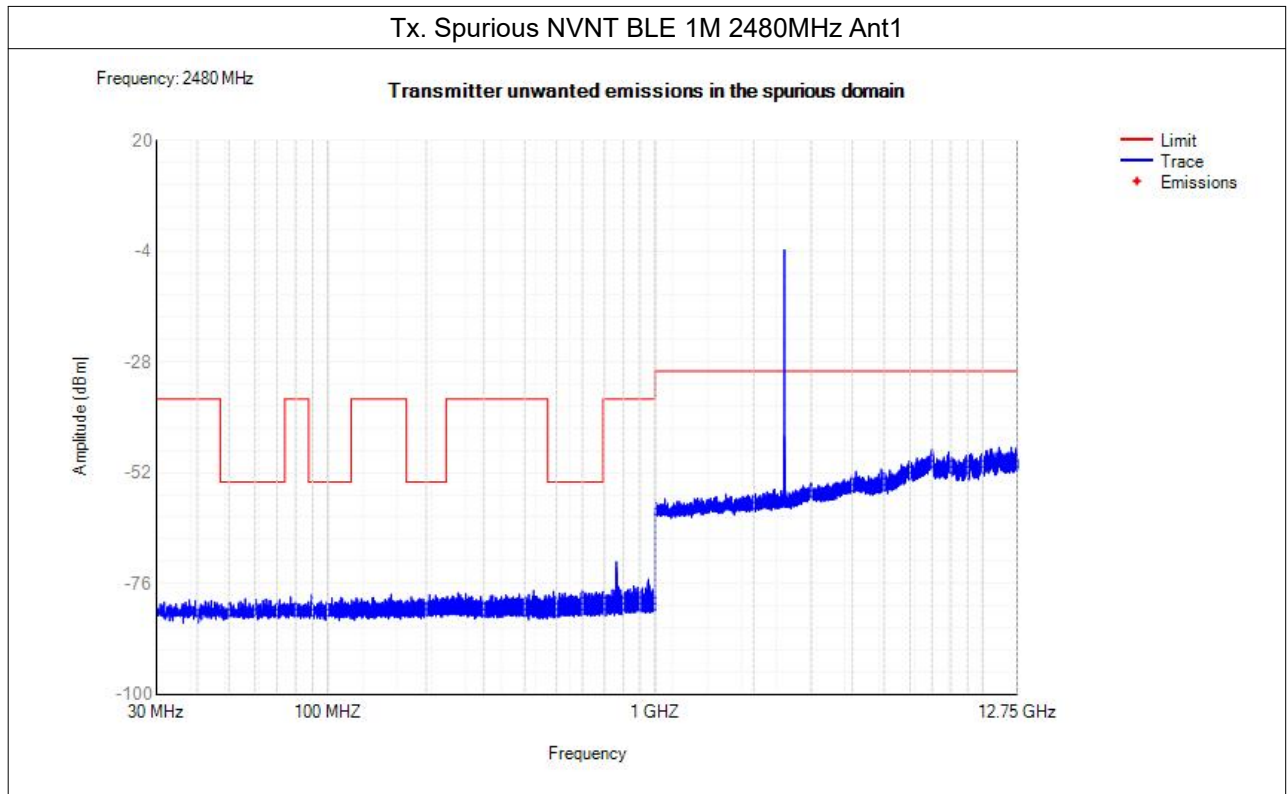

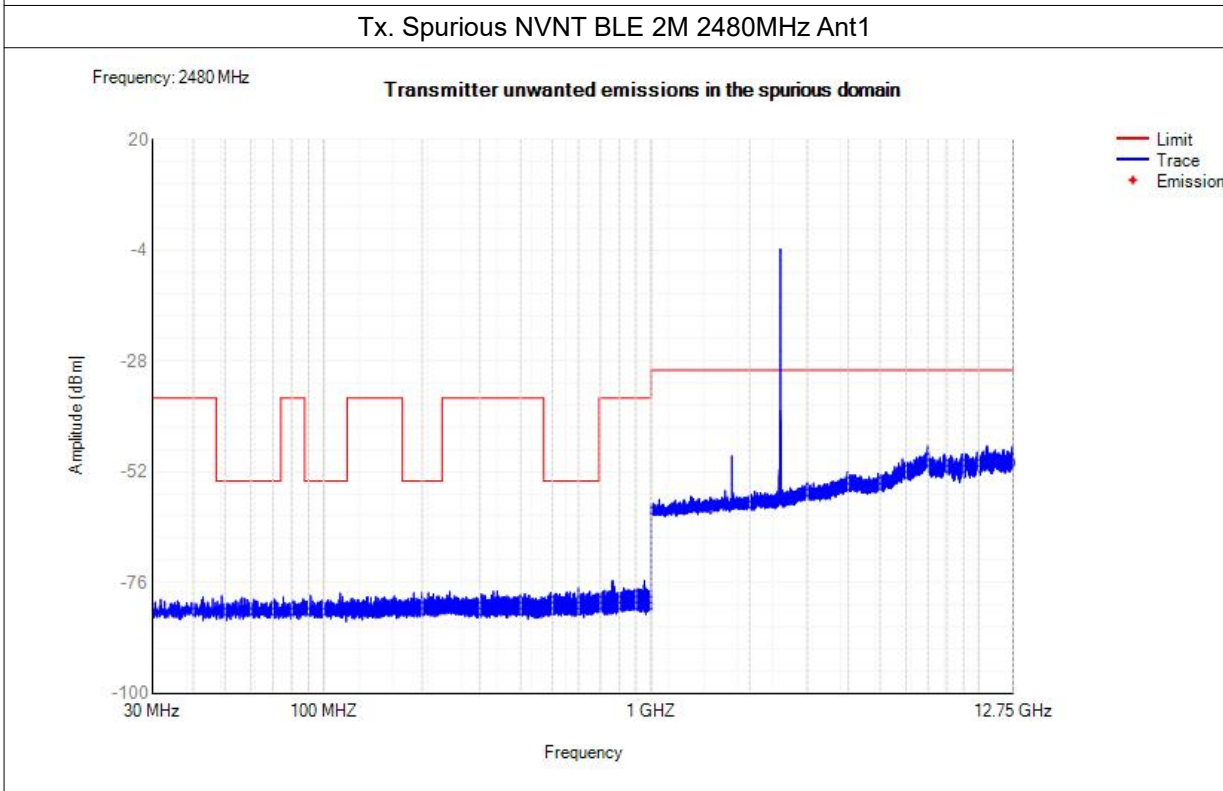
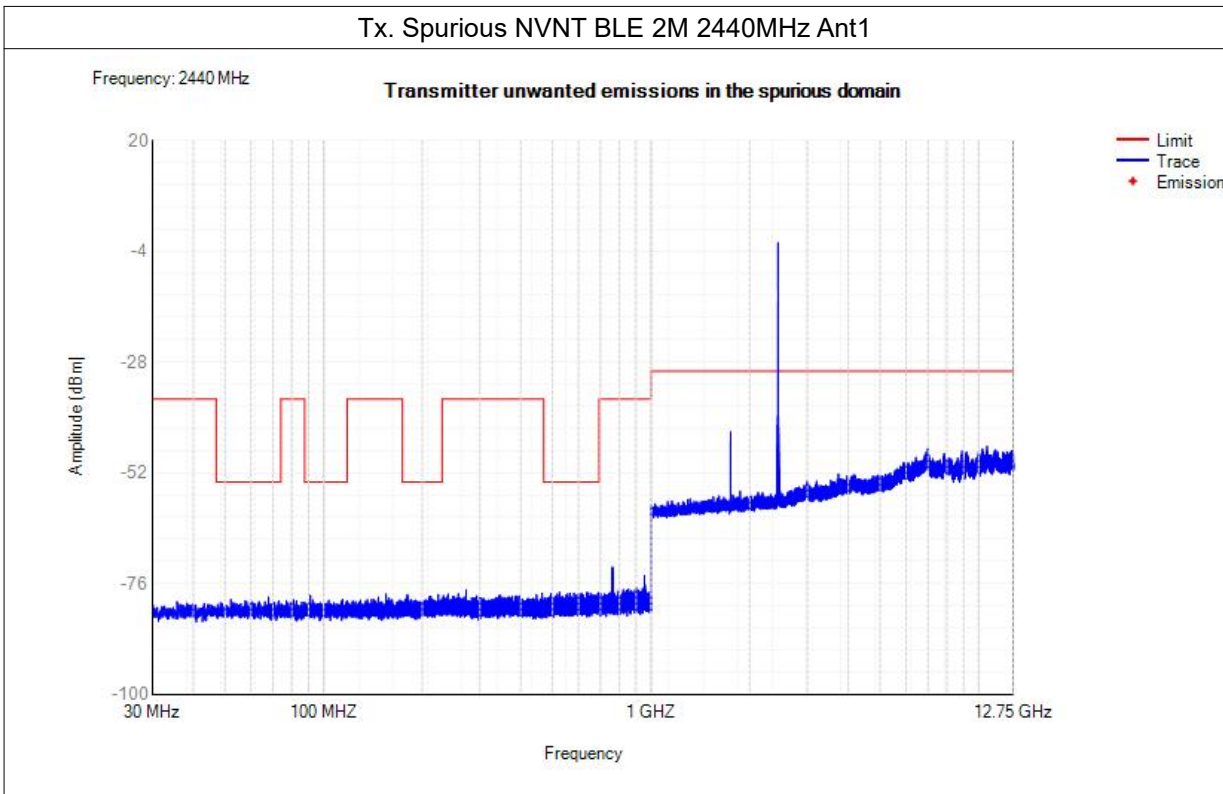

Radiated Method:

(Worst Case: GFSK_Low channel)

below 1 GHz				
Maximum Frequency	Spurious Emission		Limit	Over Limit
	polarization and Level			
MHz	Polarization	dBm	dBm	dB
69.746	Vertical	-68.62	-54.00	-14.62
166.355	Vertical	-69.59	-36.00	-33.59
497.797	Vertical	-65.91	-36.00	-29.91
104.032	Horizontal	-62.40	-36.00	-26.40
215.444	Horizontal	-68.70	-36.00	-32.70
528.217	Horizontal	-66.23	-36.00	-30.23
Above 1 GHz				
Maximum Frequency	Spurious Emission		Limit	Over Limit
	polarization and Level			
MHz	polarization	dBm	dBm	dB
4626.00	Vertical	-41.09	-30.00	-11.09
7481.00	Vertical	-46.11	-30.00	-16.11
4626.00	Horizontal	-40.02	-30.00	-10.02
7481.00	Horizontal	-40.37	-30.00	-10.37

(Worst Case: GFSK_High channel)

below 1 GHz				
Maximum Frequency	Spurious Emission		Limit	Over Limit
	polarization and Level			
MHz	polarization	dBm	dBm	dB
69.738	Vertical	-68.24	-54	-14.24
166.051	Vertical	-69.78	-36	-33.78
498.258	Vertical	-65.82	-36	-29.82
104.161	Horizontal	-62.86	-36	-26.86
215.918	Horizontal	-68.74	-36	-32.74
528.091	Horizontal	-66.12	-36	-30.12
Above 1 GHz				
Maximum Frequency	Spurious Emission		Limit	Over Limit
	polarization and Level			
MHz	polarization	dBm	dBm	dB
4871.00	Vertical	-41.01	-30	-11.01
7359.00	Vertical	-46.50	-30	-16.50
4871.00	Horizontal	-40.06	-30	-10.06
7359.00	Horizontal	-40.37	-30	-10.37

Note:

- 1.Others emission at least have 20dBm margin. No recording in the test report.
- 2.All the modes had been tested, but only the worst data recorded in the report.

Appendix F. Receiver spurious emissions

Measurement Data:

Conducted Method:

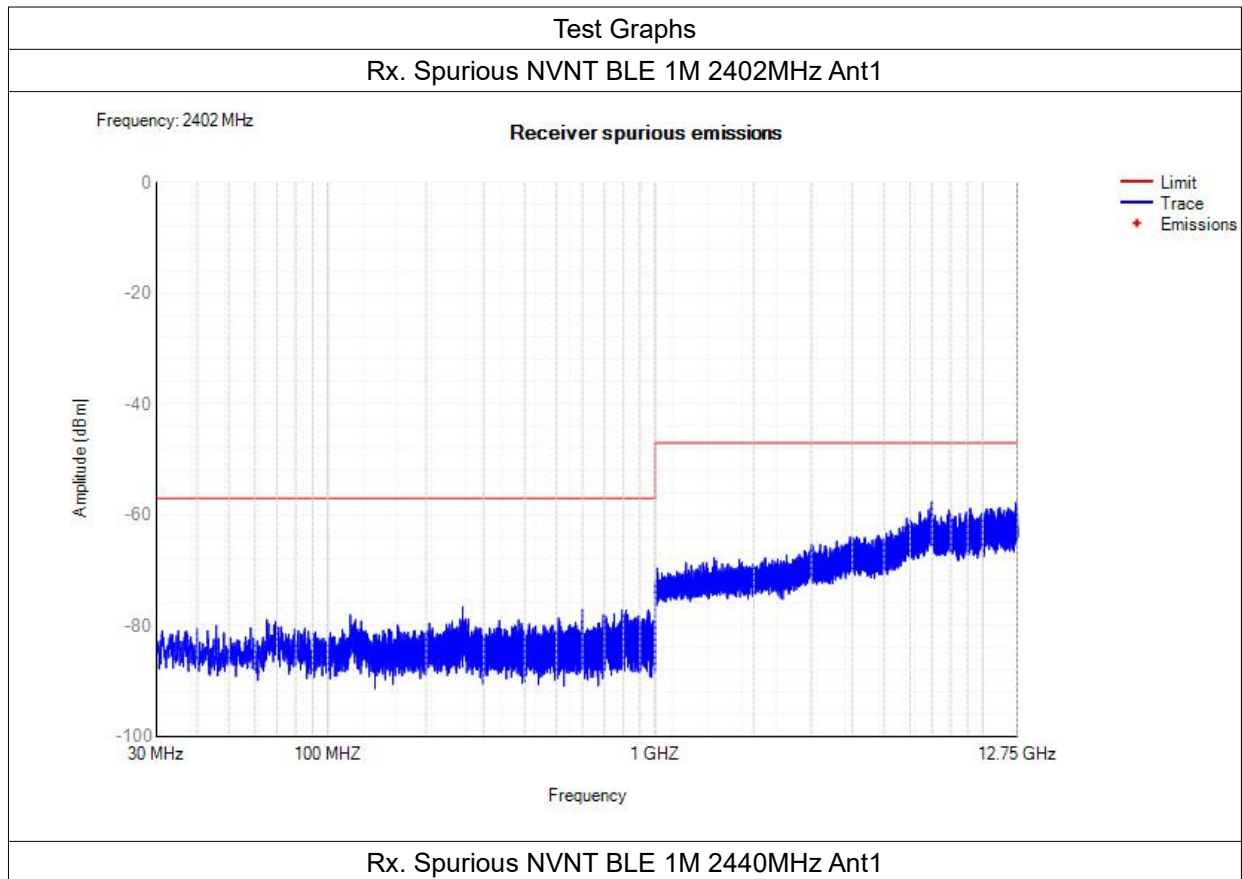

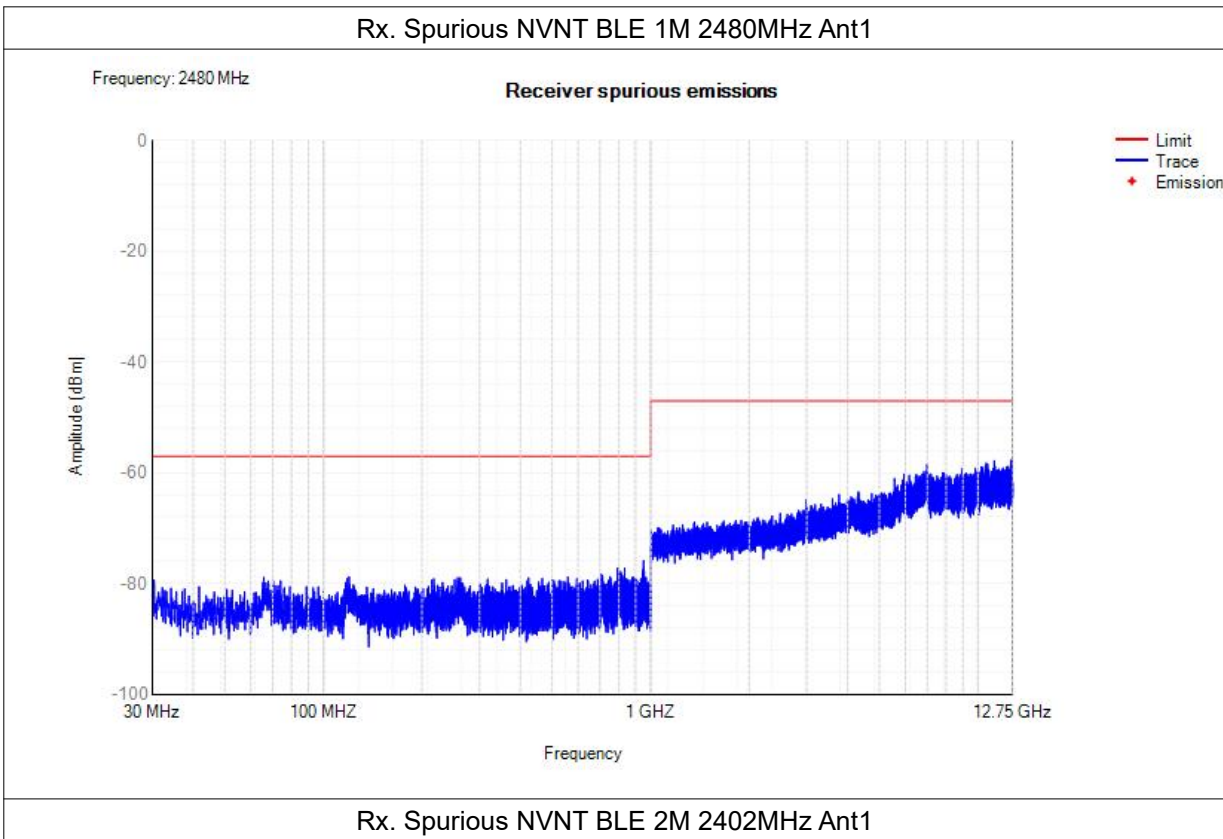
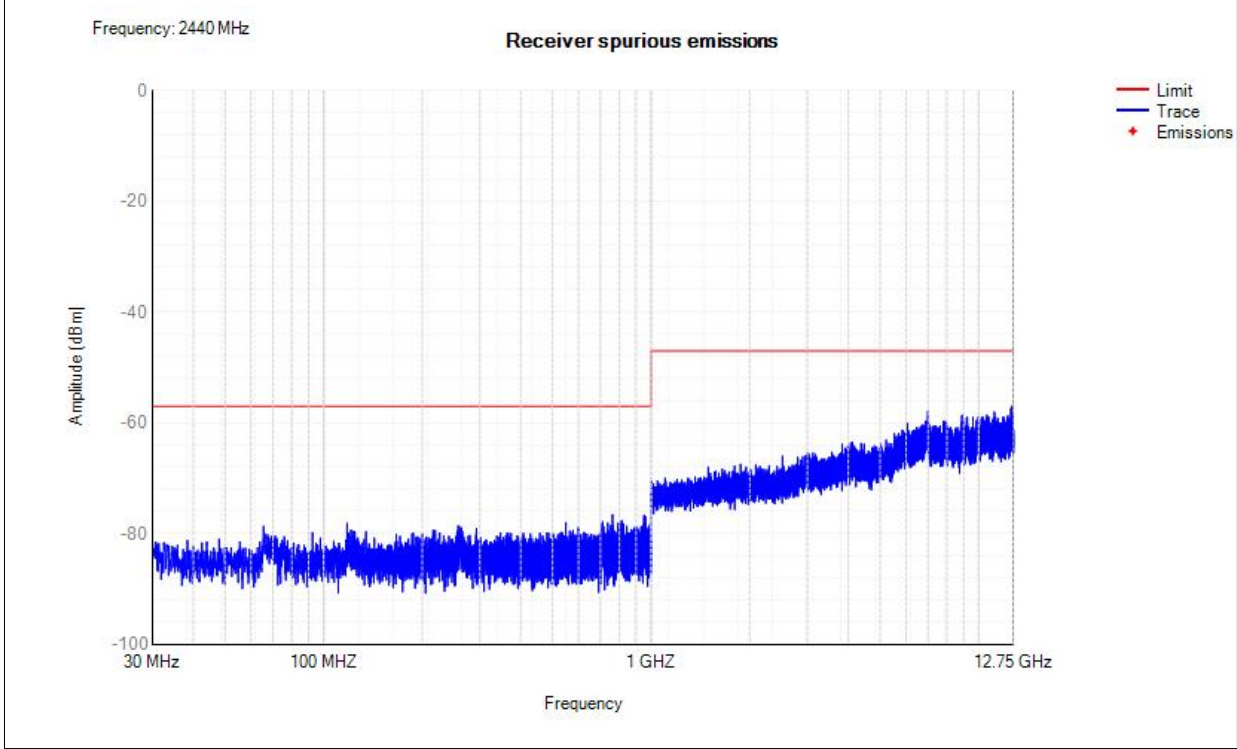

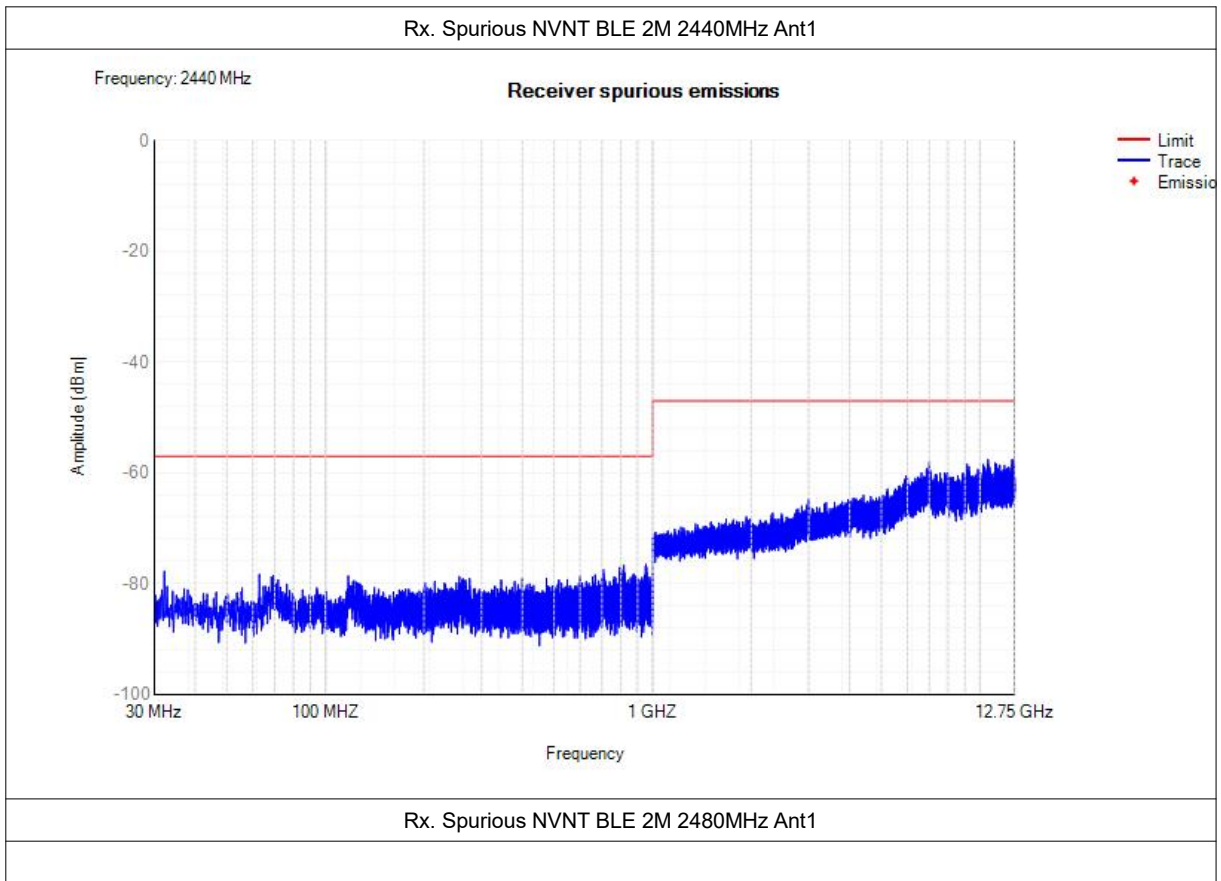
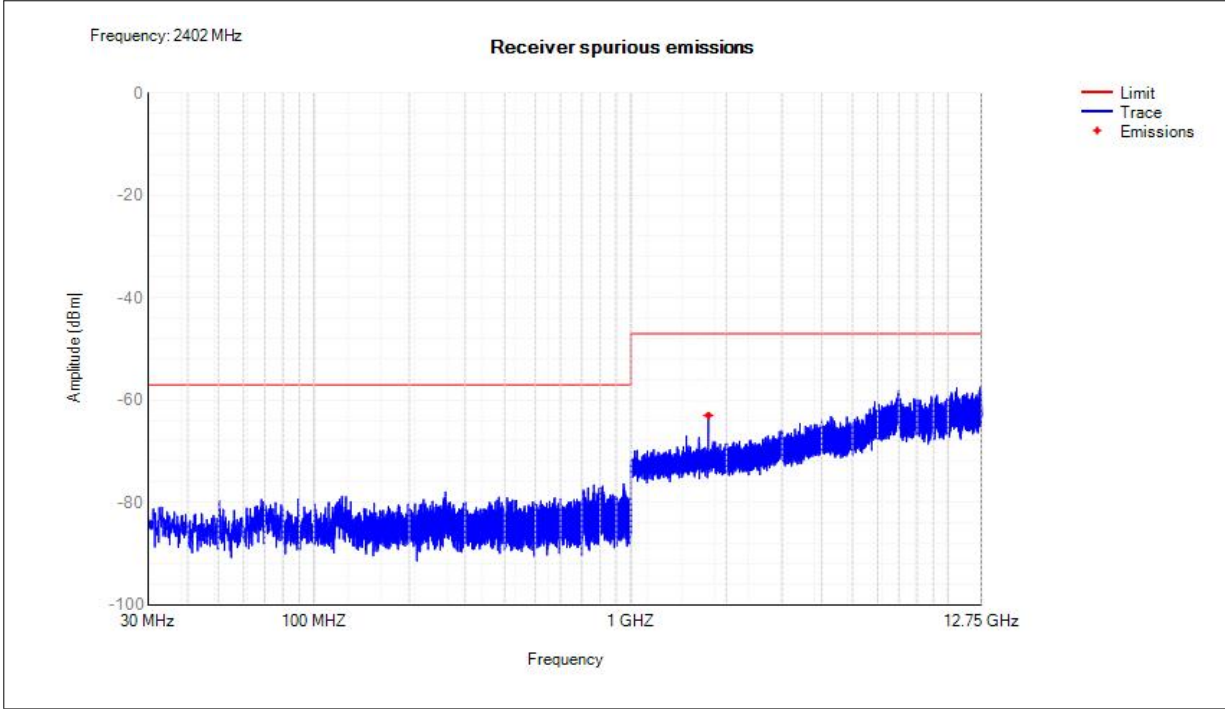

Radiated Method:

(Worst Case: Low channel)

below 1 GHz				
Maximum Frequency	Spurious Emission polarization and Level		Limit	Over Limit
	MHz	polarization		
230.87	Vertical	-65.14	-57	-8.14
1470.83	Vertical	-65.06	-57	-8.06
3153.06	Vertical	-63.64	-57	-6.64
359.42	Horizontal	-64.92	-57	-7.92
1825.01	Horizontal	-64.08	-57	-7.08
3178.94	Horizontal	-65.91	-57	-8.91
Above 1 GHz				
Maximum Frequency	Spurious Emission polarization and Level		Limit	Over Limit
	MHz	polarization		
1455.21	Vertical	-64.72	-47	-17.72
2817.64	Vertical	-65.74	-47	-18.74
5191.69	Vertical	-63.76	-47	-16.76
2085.20	Horizontal	-65.36	-47	-18.36
2755.48	Horizontal	-63.41	-47	-16.41
4902.37	Horizontal	-65.63	-47	-18.63

Note: 1. The margins of the other spectrum are not exceeding the minimum value of margin, and this part of the results without recording in the test report.

2. Measurements above show only up to 6 maximum emissions noted, or would be lesser, with "--" remark, if no specific emission from the EUT are recorded (ie: margin>20dB from the applicable limit) and considered that's already beyond the background noise floor.

Appendix G. Receiver Blocking

Worst Case(LE_1M) Measurement Data:

Test Data of Receiver Blocking						
Test channel	Blocking Signal Frequency (MHz)	Blocking Signal Power(dBm)	Wanted signal mean power from companion device(dBm)	Performance PER	Limit PER	Result
Low	2 300	-32.8	-58.94	1.51%	10%	Pass
	2 380	-32.8	-58.94	1.34%	10%	Pass
High	2 504	-32.8	-55.93	1.79%	10%	Pass
	2 584	-32.8	-55.93	1.03%	10%	Pass

Note: The levels of the blocking signal and wanted signal have to be corrected for the (in-band) antenna assembly gain.

7 Test Setup Photographs

RADIATED EMISSION TEST SETUP



RADIATED EMISSION ABOVE 1G TEST SETUP



-----END OF REPORT-----