

Radio Test Report-2.4G WIFI

ETSI EN 300 328 V2.2.2 (2019-07)

Client Information:

Applicant: DOKE COMMUNICATION (HK) LIMITED
Applicant add.: RM 1902 EASEY COMM BLDG 253-261 HENNESSY ROAD WANCHAI HK
CHINA

Product Information:

Product Name: Tablet
Model No.: Tab 11 WIFI
Serial Model: N/A
Brand Name: Blackview
Report No.: AIT23042604-1

Prepared By:

Dongguan Yaxu (AiT) Technology Limited

No.22, Jinqianling Third Street, Jitigang, Huangjiang, Dongguan,
Guangdong, China

Tel.: +86-769-8202 0499 Fax.: +86-769-8202 0495

Date of Receipt: 2023.04.26

Date of Test: 2023.04.27~2023.05.23

Date of Issue: 2023.05.23

Test Result: Pass

This device has been tested and found to comply with the stated standard(s), which is (are) required by the council directive of 2014/53/EU and indicated in the test report and are applicable only to the tested sample identified in the report.

Note: This report shall not be reproduced except in full, without the written approval of Dongguan Yaxu (AiT) Technology Limited, this document may be altered or revised by Dongguan Yaxu (AiT) Technology Limited, personal only, and shall be noted in the revision of the document. This test report must not be used by the client to claim product endorsement.

Reviewed by:



Simba huang

Approved by:



Seal.chen



Contents

	Page
COVER PAGE	
CONTENTS	2
1 VERSION	4
2 TEST SUMMARY	5
2.1 COMPLIANCE WITH ETSI EN 300 328 V2.2.2 (2019-07)	5
3 TEST FACILITY	6
3.1 DEVIATION FROM STANDARD	6
3.2 ABNORMALITIES FROM STANDARD CONDITIONS	6
4 GENERAL INFORMATION	7
4.1 GENERAL DESCRIPTION OF EUT	7
4.2 DESCRIPTION OF TEST SETUP	9
4.3 PERIPHERAL LIST	9
4.4 EUT PERIPHERAL LIST	9
4.5 MEASUREMENT UNCERTAINTY	9
4.6 EQUIPMENTS LIST FOR ALL TEST ITEMS	10
5 RADIO TECHNICAL REQUIREMENTS SPECIFICATION IN EN 300 328	11
5.1 TRANSMITTER CONDITIONS	11
5.2 TEST CONDITIONS	11
5.2.1 Normal conditions	11
5.2.2 Extreme conditions	11
6 TRANSMITTER REQUIREMENTS	12
6.1 RF OUTPUT POWER	12
6.1.1 Limit(ETSI EN 300 328 V2.2.2 (2019-07) Clause 4.3.1.2.3)	12
6.1.2 Test procedure	12
6.1.3 Test Setup	12
6.1.4 Test result	13
6.2 POWER SPECTRAL DENSITY	14
6.2.1 Limit(ETSI EN 300 328 V2.2.2 (2019-07) Clause 4.3.2.3.3)	14
6.2.2 Test procedure	14
6.2.3 Test Setup	14
6.2.4 Test result	15
6.3 OCCUPIED CHANNEL BANDWIDTH	16
6.3.1 Limit(ETSI EN 300 328 V2.2.2 (2019-07) Clause 4.3.2.7.3)	16
6.3.2 Test procedure	16
6.3.3 Test Setup	16
6.3.4 Test result	17
6.4 TRANSMITTER UNWANTED EMISSIONS IN THE OOB DOMAIN	18

6.4.1 Limit(ETSI EN 300 328 V2.2.2 (2019-07) Clause 4.3.2.8.3).....	18
6.4.2 Test procedure	18
6.4.3 Test Setup	18
6.4.4 Test result	19
6.5 ADAPTIVITY (CHANNEL ACCESS MECHANISM)	20
6.5.1 Limit(ETSI EN 300 328 V2.2.2 (2019-07) Clause 4.3.2.6).....	20
6.5.2 Test procedure	21
6.5.3 TEST SETUP	21
6.5.4 List of Measurements	22
6.5.5 Test result	23
6.6 TRANSMITTER UNWANTED EMISSIONS IN THE SPURIOUS DOMAIN	27
6.6.1 Limit(ETSI EN 300 328 V2.2.2 (2019-07) Clause 4.3.2.9.3).....	27
6.6.2 Test procedure	27
6.6.3 TEST SETUP	28
6.6.4 Radiated Test result.....	29
6.6.5 Conducted Test result	30
6.7 RECEIVER SPURIOUS EMISSIONS	31
6.7.1 Limit(ETSI EN 300 328 V2.2.2 (2019-07) Clause 4.3.2.10.3).....	31
6.7.2 Test Setup	31
6.7.3 Test procedure	33
6.7.4 Test Result(Radiated measurement).....	33
Test Result (Conducted measurement)	34
6.8 RECEIVER BLOCKING	35
6.8.1 Performance Criteria	35
6.8.2 Test procedure	35
6.8.3 Limit(ETSI EN 300 328 V2.2.2 (2019-07) Clause 4.3.2.11.4).....	36
6.8.4 Test Setup	38
6.8.5 Test Result	38
7 APPENDIX TEST DATA	39
Appendix A. RF Output Power (E.I.R.P.).....	39
Appendix B. Power Spectral Density	39
Appendix C. Occupied Channel Bandwidth	46
Appendix D. Transmitter unwanted emissions in the OOB domain	53
Appendix E. Transmitter unwanted emissions in the spurious domain	55
Appendix F. Receiver spurious emissions	57
Appendix G. Receiver Blocking	58
8 TEST SETUP PHOTOGRAPH	59

1 Version

REPORT REVISE RECORD

Report Version	Revise Time	Issued Date	Valid Version	Notes
V1.0	/	2023.05.23	Valid	Initial release

2 Test Summary

2.1 Compliance with ETSI EN 300 328 V2.2.2 (2019-07)

No.	Description of Test Item	Basic Standard	Results
Transmitter Parameters			
1	RF Output Power	EN300328 clause 4.3.2.2	Pass
2	Power Spectral Density	EN300328 clause 4.3.2.3	Pass
3	Duty cycle, Tx-Sequence, Tx-gap	EN300328 clause 4.3.2.4	N/A
4	Medium Utilization (MU) factor	EN300328 clause 4.3.2.5	N/A
5	Adaptivity	EN300328 clause 4.3.2.6	Pass
6	Occupied Channel Bandwidth	EN300328 clause 4.3.2.7	Pass
7	Transmitter unwanted emission in the OOB domain	EN300328 clause 4.3.2.8	Pass
8	Transmitter unwanted emissions in the spurious domain	EN300328 clause 4.3.2.9	Pass
9	Geo-location capability	EN 300 328 Clause 4.3.2.12	N/A
Receiver Parameters			
10	Receiver spurious emissions	EN300328 clause 4.3.2.10	Pass
11	Receiver Blocking	EN300328 clause 4.3.2.11	Pass

3 Test Facility

The test facility is recognized, certified or accredited by the following organizations:

.CNAS- Registration No: L6177

Dongguan Yaxu (AiT) technology Limited is accredited to ISO/IEC 17025:2017 general Requirements for the competence of testing and calibration laboratories (CNAS-CL01 Accreditation Criteria for the competence of testing and calibration laboratories) on Aug. 04, 2020

3.1 Deviation from Standard

None

3.2 Abnormalities from Standard Conditions

None

4 General Information

4.1 General Description of EUT

Manufacturer:	Shenzhen DOKE Electronic Co., Ltd
Manufacturer Address:	801, Building3, 7th Industrial Zone, Yulv Community, Yutang Road, Guangming District, Shenzhen, China
EUT Name:	Tablet
Model No:	Tab 11 WIFI
Serial Model	N/A
Brand Name:	Blackview
Operation Frequency:	802.11b/g/n(20MHz): 2412~2472MHz,802.11n(40MHz):2422~2462MHz
Modulation Type:	IEEE 802.11b : DSSS (DBPSK, DQPSK, CCK) IEEE 802.11g/n (HT20/HT40) : OFDM(64QAM, 16QAM, QPSK, BPSK)
Receiver categories	802.11b:1,802.11g/n20/n40:1
Adaptive/non-adaptive	Adaptive equipment
Antenna Designation	FPC Antenna
Antenna Gain:	1.0dBi
Hardware Version:	WT_DK047_8183_BED_UMCP_MB_V2.0
Software Version:	Tab11WiFi_NEU_MT8183_V1.0
Battery:	DC 3.8V 8380mAh for Battery

Note:For a more detailed features description, please refer to the manufacturer's specifications or the User's Manual.

Description of Channel:					
802.11b/g/n(20MHz)					
Channel	Frequency (MHz)	Channel	Frequency (MHz)	Channel	Frequency (MHz)
01	2412	06	2437	11	2462
02	2417	07	2442	12	2467
03	2422	08	2447	13	2472
04	2427	09	2452		
05	2432	10	2457		
802.11n(40MHz)					
03	2422	06	2437	09	2452
04	2427	07	2442	10	2457
05	2432	08	2447	11	2462

4.2 Description of Test setup

EUT was tested in normal configuration (Please See following Block diagrams)

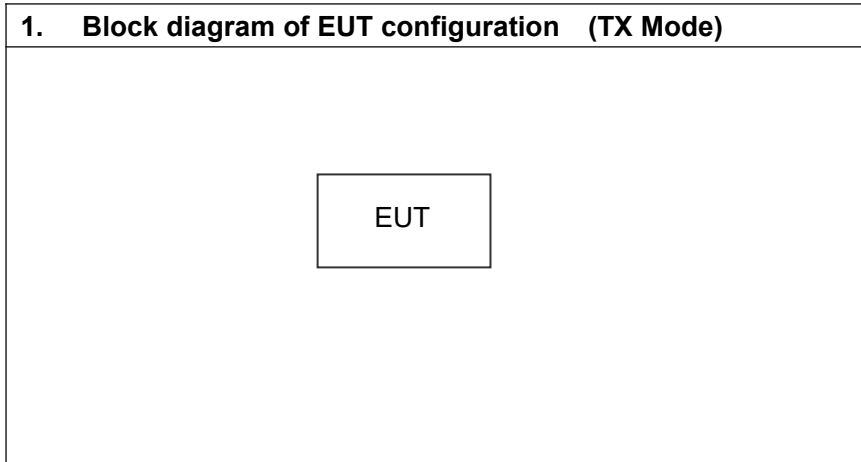

4.3 Peripheral List

No.	Equipment	Manufacturer	Model No.	Serial No.	Power cord	signal cable
1	N/A	N/A	N/A	N/A	N/A	N/A

4.4 EUT Peripheral List

No.	Equipment	Manufacturer	EMC Compliance	Model No.	Serial No.	Power cord	signal cable
1	Adapter	Shenzhen Keyu Power Supply Technologu Co., Ltd	CE	GYS-A5020S1	N/A	0.8m/ unshielded /undetectable	N/A

4.5 Measurement Uncertainty

No.	Item	Uncertainty
1	Conducted Emission Test	1.20dB
2	Radiated Emission Test	3.30dB
3	RF power,conducted	0.16dB
4	RF power density,conducted	0.24dB
5	Spurious emissions,conducted	0.21dB
6	All emissions,radiated(<1G)	4.68dB
7	All emissions,radiated(>1G)	4.89dB

4.6 Equipments List for All Test Items

No	Test Equipment	Manufacturer	Model No	Serial No	Cal. Date	Cal. Due Date
1	Spectrum Analyzer	R&S	FSV40	101470	2022.09.02	2023.09.01
2	EMI Measuring Receiver	R&S	ESR	101160	2022.09.02	2023.09.01
3	Low Noise Pre Amplifier	HP	HP8447E	AiT-F01319	2022.09.02	2023.09.01
4	Low Noise Pre Amplifier	Tsj	MLA-0120-A02-34	2648A04738	2022.09.02	2023.09.01
5	Passive Loop	ETS	6512	00165355	2022.09.04	2024.09.03
6	TRILOG Super Broadband test Antenna	SCHWARZBECK	VULB9160	9160-3206	2021.08.29	2024.08.28
7	Broadband Horn Antenna	SCHWARZBECK	BBHA9120D	452	2021.08.29	2024.08.28
8	SHF-EHF Horn Antenna 15-40GHz	SCHWARZBECK	BBHA9170	BBHA9170367d	2020.11.24	2023.11.23
9	EMI Test Receiver	R&S	ESCI	100124	2022.09.02	2023.09.01
10	LISN	Kyoritsu	KNW-242	8-837-4	2022.09.02	2023.09.01
11	LISN	R&S	ESH3-Z2	0357.8810.54 - 101161-S2	2022.09.02	2023.09.01
12	Pro.Temp&Humi.chamber	MENTEK	MHP-150-1C	MAA08112501	2022.09.02	2023.09.01
13	RF Automatic Test system	MW	MW100-RFCB	21033016	2022.09.02	2023.09.01
14	Signal Generator	Agilent	N5182A	MY50143009	2022.09.02	2023.09.01
15	Wideband Radio communication tester	R&S	CMW500	1201.0002K50	2022.09.02	2023.09.01
16	RF Automatic Test system	MW	MW100-RFCB	21033016	2022.09.02	2023.09.01
17	DC power supply	ZHAOXIN	RXN-305D-2	28070002559	N/A	N/A
18	RE Software	EZ	EZ-EMC_RE	Ver.AIT-03A	N/A	N/A
19	CE Software	EZ	EZ-EMC_CE	Ver.AIT-03A	N/A	N/A
20	RF Software	MW	MTS 8310	2.0.0.0	N/A	N/A

5 Radio Technical Requirements Specification in EN 300 328

5.1 Transmitter Conditions

Item	EUT Type
1	stand-alone radio equipment with or without their own control provisions;
2	plug-in radio devices intended for use with or within a variety of host systems, e.g. personal computers, hand-held terminals, etc.;
3	plug-in radio devices intended for use within combined equipment, e.g. cable modems, set-top boxes, access points, etc.;
4	Combined equipment or a combination of a plug-in radio device and a specific type of host equipment.

Modulation
DSSS

EUT belongs to item 1 with DSSS modulation.

5.2 Test conditions

5.2.1 Normal conditions

Ambient:	Temperature:	+15°C to +35°C
	Relative humidity:	20% to 75%
	Press:	1010 mbar
Power supply:	AC	AC 230V for adapter
	DC	3.85V

5.2.2 Extreme conditions

Ambient:	Temperature:	-10 °C to +50 °C (Which declared by manufacture)
Power supply:	DC	3.465V ~4.235V

6 Transmitter Requirements

6.1 RF Output Power

6.1.1 Limit(ETSI EN 300 328 V2.2.2 (2019-07) Clause 4.3.1.2.3)

RF OUTPUT POWER	
Condition	Limit
<input type="checkbox"/> Non-adaptive wide band modulations systems	Equal to or less than the value declared by the supplier. This declared value shall be equal to or less than 20 dBm.
<input checked="" type="checkbox"/> Adaptive wide band modulations systems	≤20dBm

6.1.2 Test procedure

1. Refer to chapter 5.4.2.2 of ETSI EN 300 328 V2.2.2 (2019-07)

Measurement	
<input checked="" type="checkbox"/> Conducted measurement	<input type="checkbox"/> Radiated measurement

6.1.3 Test Setup

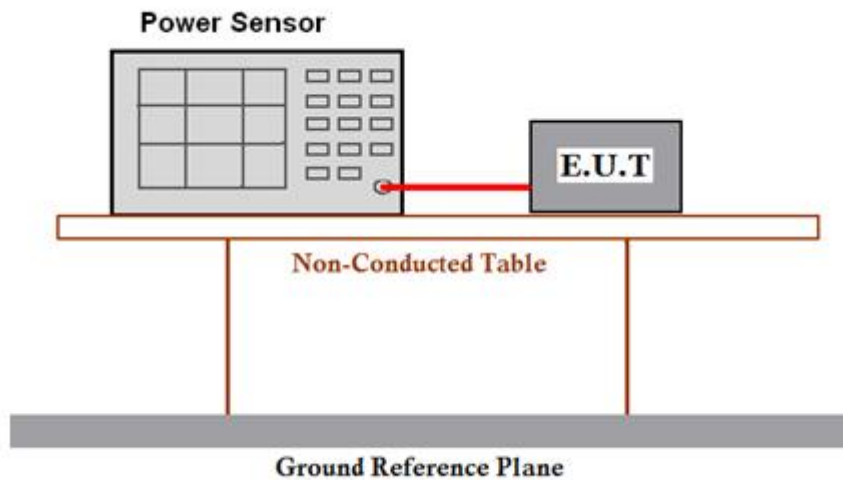

6.1.4 Test result

For test data, please refer to the appendix results.

6.2 Power Spectral Density

6.2.1 Limit(ETSI EN 300 328 V2.2.2 (2019-07) Clause 4.3.2.3.3)

RF OUTPUT POWER	
Condition	Limit
For equipment using wide band modulations other than FHSS	≤10 dBm/MHz

6.2.2 Test procedure

Refer to chapter 5.4.3.2 of ETSI EN 300 328 V2.2.2 (2019-07)

Measurement	
<input checked="" type="checkbox"/> Conducted measurement	<input type="checkbox"/> Radiated measurement

The setting of the Spectrum Analyzer

Start Frequency	2400MHz
Stop Frequency	2483.5MHz
Detector	RMS
Sweep Point	> 8 350; for spectrum analysers not supporting this number of sweep points, the frequency band may be segmented
Sweep time	For non-continuous transmissions: 2 × Channel Occupancy Time × number of sweep points For continuous transmissions: 10 s; the sweep time may be increased further until a value where the sweep time has no further impact anymore on the RMS value of the signal
RBW / VBW	10KHz / 30KHz

6.2.3 Test Setup



6.2.4 Test result

For test data, please refer to the appendix results.

6.3 Occupied Channel Bandwidth

6.3.1 Limit(ETSI EN 300 328 V2.2.2 (2019-07) Clause 4.3.2.7.3)

OCCUPIED CHANNEL BANDWIDTH		
Condition		Limit
All types of equipment		Shall fall completely within the band 2400 to 2483.5 MHz
Additional requirement	For non-adaptive using wide band modulations other than FHSS system and E.I.R.P >10 dBm	Less than 20 MHz
	For non-adaptive frequency hopping system and E.I.R.P >10 dBm	Less than 5 MHz

6.3.2 Test procedure

Refer to chapter 5.4.7.2 of ETSI EN 300 328 V2.2.2 (2019-07)

Measurement	
<input checked="" type="checkbox"/> Conducted measurement	<input type="checkbox"/> Radiated measurement

The setting of the Spectrum Analyzer

Center Frequency	The centre frequency of the channel under test
Frequency Span	2 × Nominal Channel Bandwidth
Detector	RMS
RBW	~ 1 % of the span without going below 1 %
VBW	3 × RBW
Trace	Max hold
Sweep time	1s

6.3.3 Test Setup



6.3.4 Test result

For test data, please refer to the appendix results.

6.4 Transmitter unwanted emissions in the OOB domain

6.4.1 Limit(ETSI EN 300 328 V2.2.2 (2019-07) Clause 4.3.2.8.3)

Transmitter unwanted emissions in the OOB domain	
Condition	Limit
Under all test conditions	The transmitter unwanted emissions in the out-of-band domain but outside the allocated band, shall not exceed the values provided by the mask in below figure.

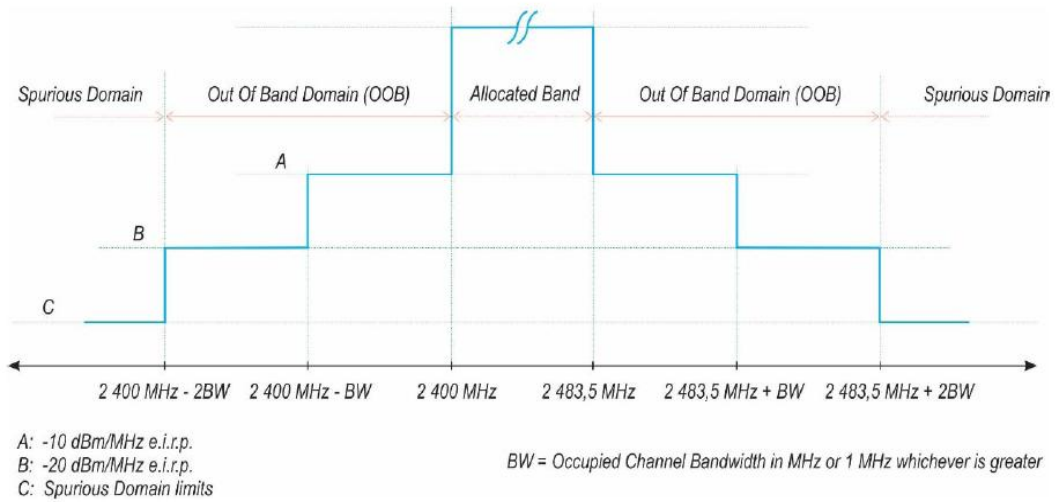

6.4.2 Test procedure

Refer to ETSI EN 300 328 V2.2.2 (2019-07) Clause 5.4.8.2

Measurement	
<input checked="" type="checkbox"/> Conducted measurement	<input type="checkbox"/> Radiated measurement

The setting of the Spectrum Analyzer

Span	0Hz
Filter Mode	Channel Filter
Trace Mode	Max Hold
Trigger Mode	Video trigger; in case video triggering is not possible, an external trigger source may be used
Detector	RMS
Sweep Point / Sweep Mode	Sweep Time [s] / (1 μ s) or 5 000 whichever is greater/ Continuous
RBW / VBW	1MHz / 3MHz

6.4.3 Test Setup

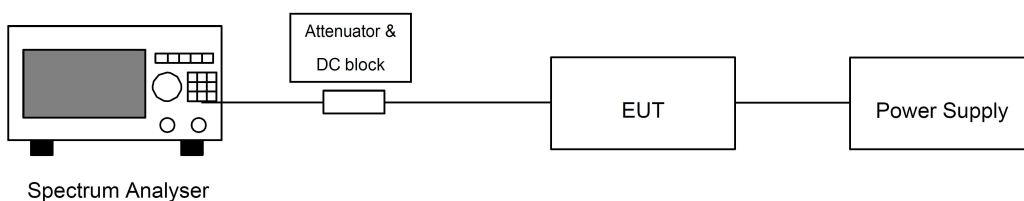

6.4.4 Test result

Measurement Data:

For test data, please refer to the appendix results.

6.5 Adaptivity (Channel access mechanism)

6.5.1 Limit(ETSI EN 300 328 V2.2.2 (2019-07) Clause 4.3.2.6)

Requirement	Operational Mode			
	<input type="checkbox"/> Non-LBT based Detect and Avoid	<input type="checkbox"/> LBT based Detect and Avoid		
		<input type="checkbox"/> Frame Based Equipment	<input type="checkbox"/> Load Based Equipment (CCA using 'energy detect')	<input type="checkbox"/> Load Based Equipment (CCA not using any of the mechanisms referenced as note 2)
Minimum Clear Channel Assessment (CCA) Time	NA	not less than 18 us (see note 1)	(see note 2)	not less than 18 us (see note 1)
Maximum Channel Occupancy (COT) Time	<40 ms	1ms to 10 ms	(see note 2)	(13/32)*q ms (see note 3)
Minimum Idle Period	5 % minimum of 100 μs	5% of COT	(see note 2)	NA
Extended CCA check	NA	NA	(see note 2)	R*CCA (see note 4)
Short Control Signalling Transmissions	Maximum duty cycle of 10% within an observation period of 50 ms (see note 5)			

Note 1: The CCA time used by the equipment shall be declared by the supplier.

Note 2: Load Based Equipment may implement an LBT based spectrum sharing mechanism based on the Clear Channel Assessment (CCA) mode using energy detect as described in IEEE 802.11™-2012 [i.3], clause 9, clause 10, clause 16, clause 17, clause 19 and clause 20, or in IEEE 802.15.4™-2011 [i.4], clause 4, clause 5 and clause 8 providing the equipment complies with the conformance requirements referred to in clause 4.3.2.6.3.4.

Note 3: q is selected by the manufacturer in the range [4...32]

Note 4: The value of R shall be randomly selected in the range [1...q]

Note 5: Adaptive equipment may or may not have Short Control Signaling Transmissions.

The detection threshold shall be proportional to the transmit power of the transmitter: for a 20 dBm e.i.r.p. transmitter the detection threshold level (TL) shall be equal to or less than -70 dBm/MHz at the input to the receiver assuming a 0 dBi (receive) antenna assembly. This threshold level (TL) may be corrected for the (receive)antenna assembly gain (G); however, beamforming gain (Y) shall not be taken into account. For power levels less than 20 dBm e.i.r.p., the detection threshold level may be relaxed to:

$$TL = -70 \text{ dBm/MHz} + 10 \times \log_{10} (100 \text{ mW} / P_{out}) \quad (P_{out} \text{ in mW e.i.r.p.})$$

Table 9: Unwanted Signal parameters

Wanted signal mean power from companion device (dBm)	Unwanted signal frequency (MHz)	Unwanted CW signal power (dBm)
-30/ sufficient to maintain the link(see note 2)	2395 or 2488,5 (see note 1)	-35 (see note 2)
<p>NOTE 1: The highest frequency shall be used for testing operating channels within the range 2 400 MHz to 2 442 MHz, while the lowest frequency shall be used for testing operating channels within the range 2 442 MHz to 2 483,5 MHz. See clause 5.4.6.1.</p> <p>NOTE 2: A typical value which can be used in most cases is -50 dBm/MHz.</p> <p>NOTE 3: The level specified is the level in front of the UUT antenna. In case of conducted measurements, this level has to be corrected by the actual antenna assembly gain.</p>		

6.5.2 Test procedure

Refer to ETSI EN 300 328 V2.2.2 (2019-07) Clause 5.4.6.2

Measurement	
<input checked="" type="checkbox"/> Conducted measurement	<input type="checkbox"/> Radiated measurement

6.5.3 TEST SETUP

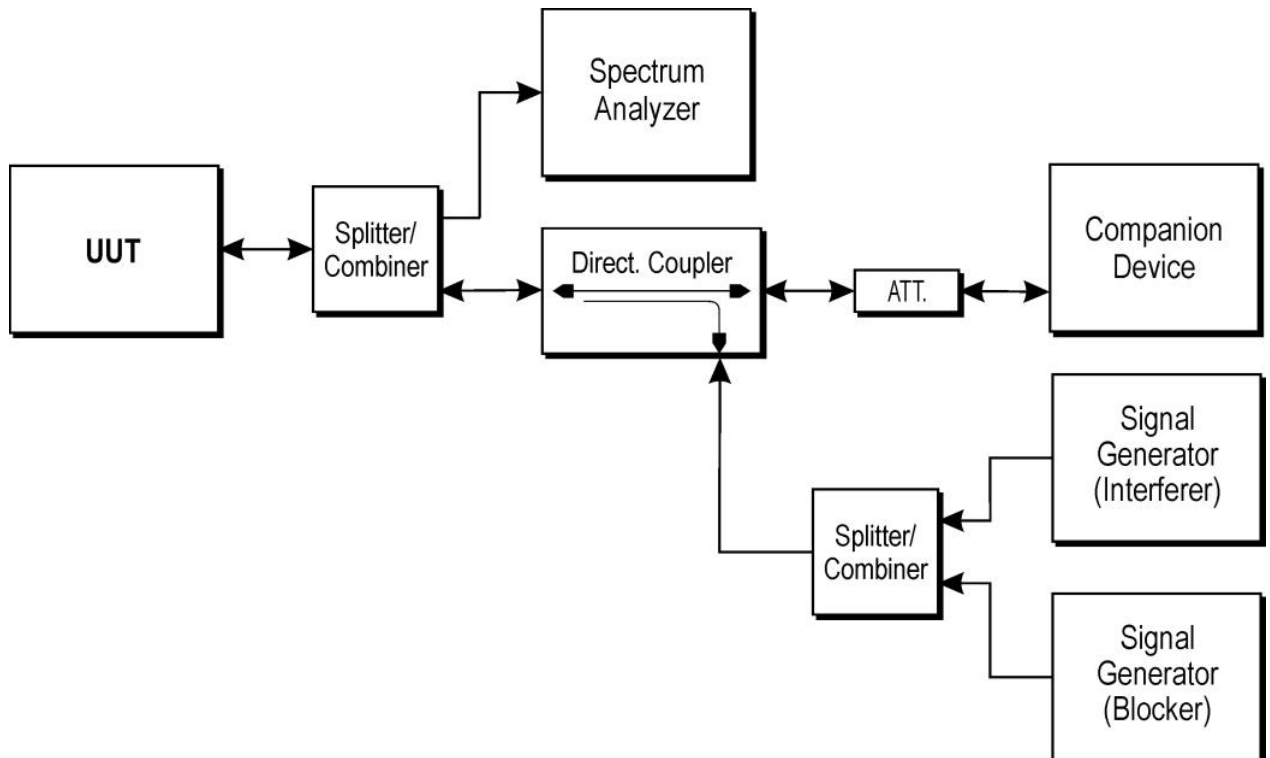

6.5.4 List of Measurements

UUT operational Mode		
Frame Based Equipment	Load Based Equipment (CCA using 'energy detect')	Load Based Equipment (CCA not using any of the mechanisms referenced)
	V	

Clause	Test Parameter	Remarks	PASS/FAIL
4.3.2.5.2.2.1	Adaptive (Frame Based Equipment)	Not Applicable	N/A
4.3.2.5.2.2.2	Adaptive (Load Based Equipment)	Applicable	PASS
4.3.2.5.3	Short Control Signaling Transmissions	Applicable	PASS

6.5.5 Test result

Test plots are below:

802.11b mode lowest channel		802.11b mode highest channel	
AWGN Interference Level (dBm)	-65.00	AWGN Interference Level (dBm)	-65.00
Blocking Interference Level (dBm)	-35	Blocking Interference Level (dBm)	-35
AWGN Interference Start Time (ms)	10001.28	AWGN Interference Start Time (ms)	10060.49
Blocking Interference Start Time (ms)	80014.45	Blocking Interference Start Time (ms)	80003.75
Max COT (ms)	0.15	Max COT (ms)	0.13
Idle Time (ms)	1.05	Idle Time (ms)	1.15
Pulse width (ms)	0.35	Pulse width (ms)	0.30
Duty Cycle (%)	0.74	Duty Cycle (%)	0.65

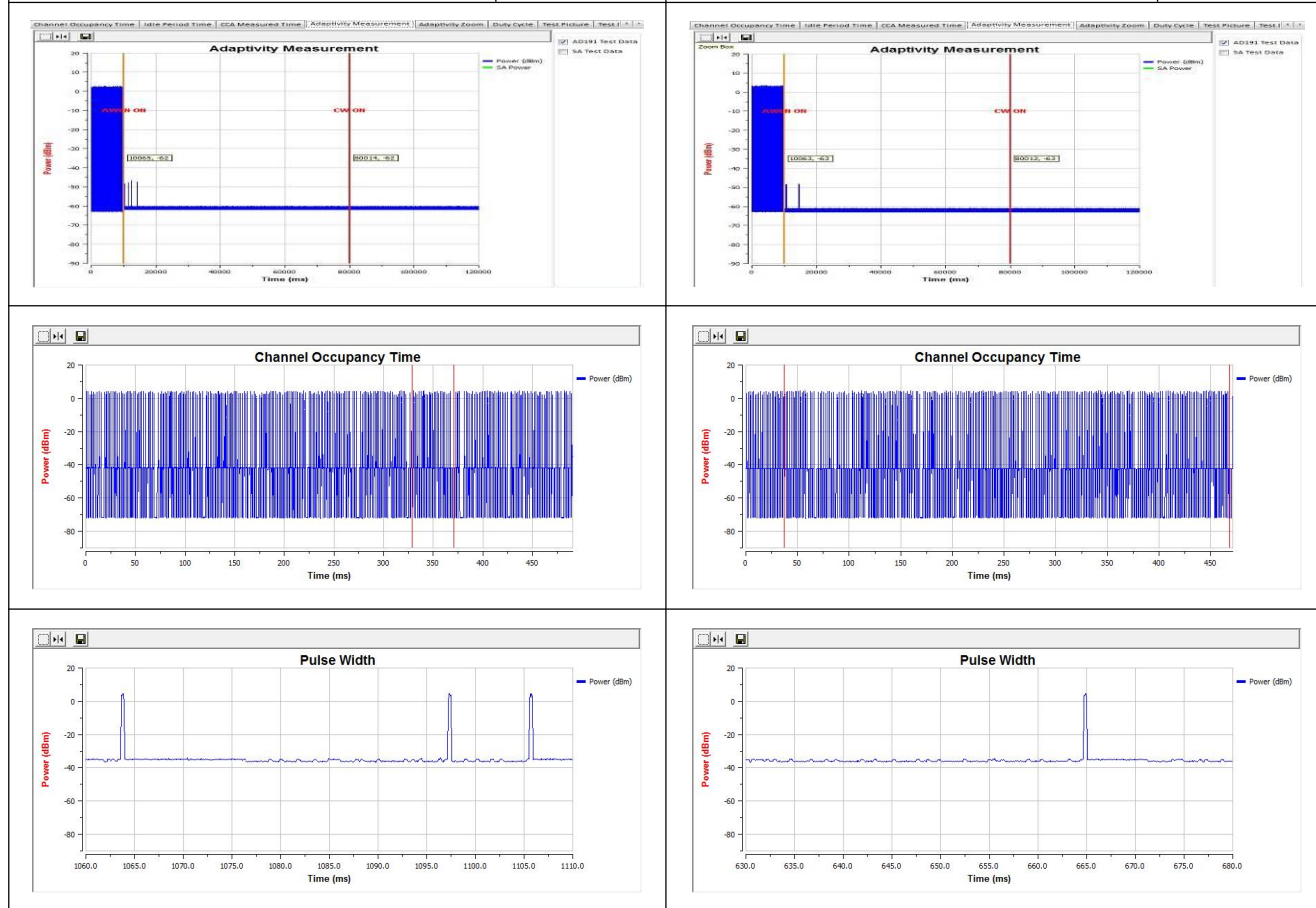

802.11g mode lowest channel		802.11g mode highest channel	
AWGN Interference Level (dBm)	-65.00	AWGN Interference Level (dBm)	-65.00
Blocking Interference Level (dBm)	-35	Blocking Interference Level (dBm)	-35
AWGN Interference Start Time (ms)	10006.96	AWGN Interference Start Time (ms)	10053.14
Blocking Interference Start Time (ms)	80014.33	Blocking Interference Start Time (ms)	80010.24
Max COT (ms)	0.13	Max COT (ms)	0.12
Idle Time (ms)	1.05	Idle Time (ms)	1.14
Pulse width (ms)	0.35	Pulse width (ms)	0.35
Duty Cycle (%)	0.76	Duty Cycle (%)	0.74

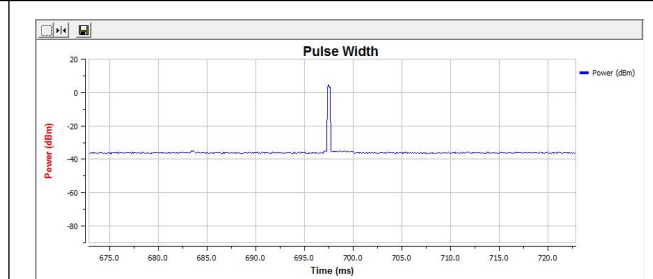
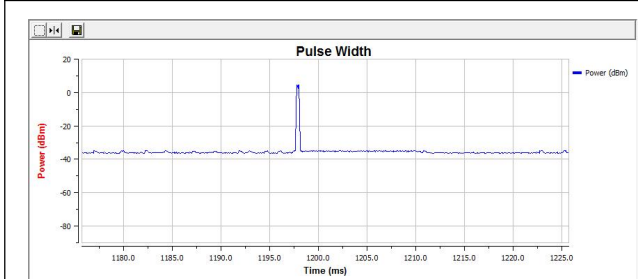
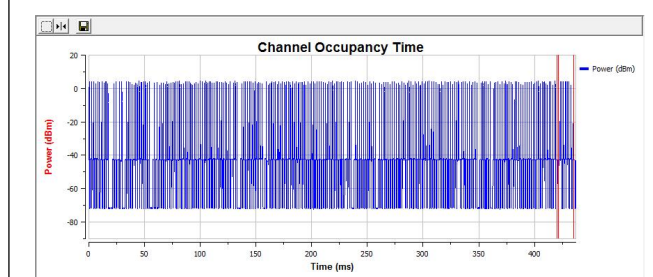
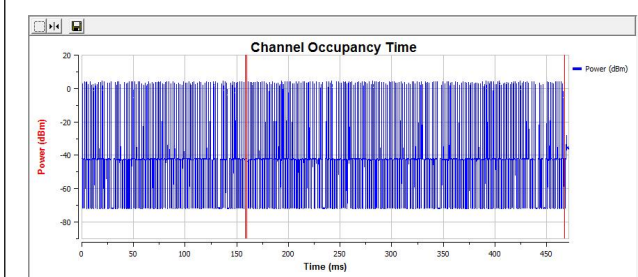
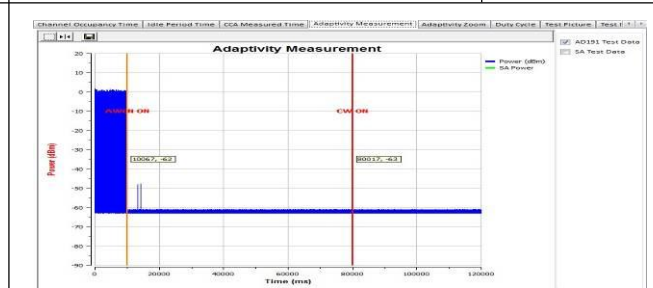
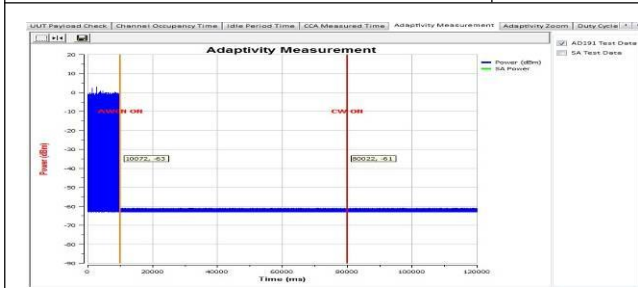

802.11n(HT20) mode lowest channel		802.11n(HT20) mode highest channel	
AWGN Interference Level (dBm)	-65.00	AWGN Interference Level (dBm)	-65.00
Blocking Interference Level (dBm)	-35	Blocking Interference Level (dBm)	-35
AWGN Interference Start Time (ms)	10052.89	AWGN Interference Start Time (ms)	10039.74
Blocking Interference Start Time (ms)	80001.36	Blocking Interference Start Time (ms)	80005.02
Max COT (ms)	0.15	Max COT (ms)	0.75
Idle Time (ms)	0.23	Idle Time (ms)	0.44
Pulse width (ms)	0.30	Pulse width (ms)	0.30
Duty Cycle (%)	0.60	Duty Cycle (%)	0.60

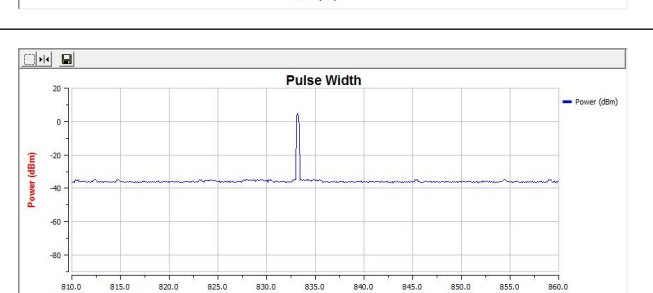
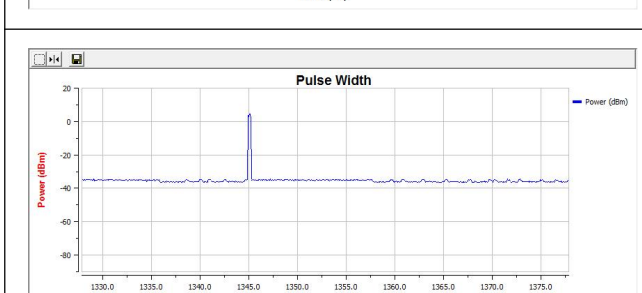
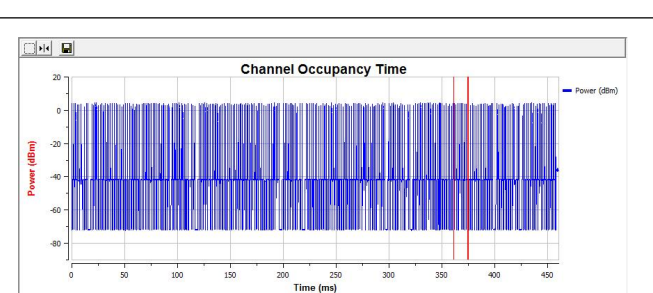
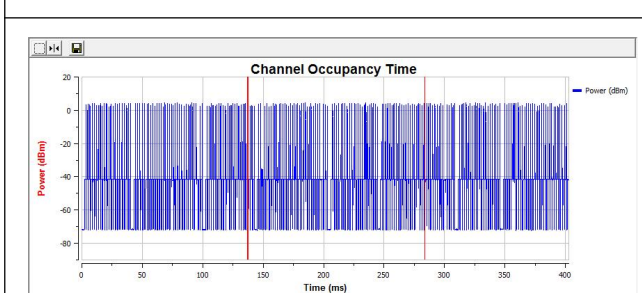
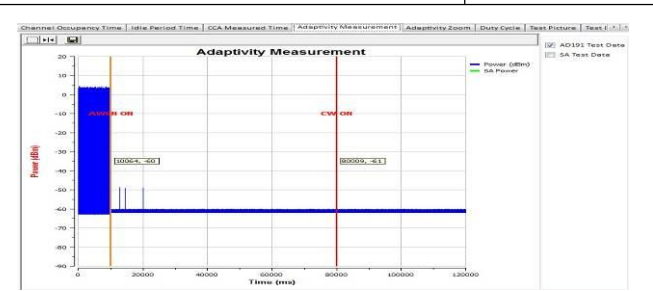
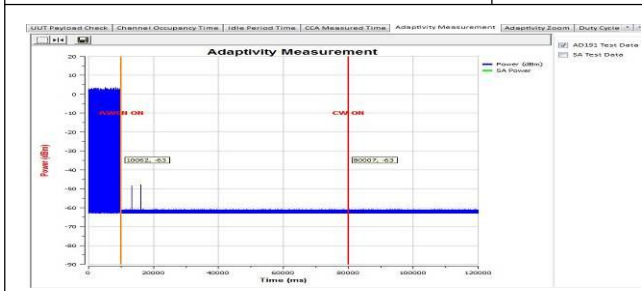

802.11n(HT40) mode lowest channel		802.11n(HT40) mode highest channel	
AWGN Interference Level (dBm)	-65.00	AWGN Interference Level (dBm)	-65.00
Blocking Interference Level (dBm)	-35	Blocking Interference Level (dBm)	-35
AWGN Interference Start Time (ms)	10039.51	AWGN Interference Start Time (ms)	10047.09
Blocking Interference Start Time (ms)	80022.05	Blocking Interference Start Time (ms)	80003.05
Max COT (ms)	0.12	Max COT (ms)	0.30
Idle Time (ms)	1.02	Idle Time (ms)	0.24
Pulse width (ms)	0.30	Pulse width (ms)	0.30
Duty Cycle (%)	0.60	Duty Cycle (%)	0.60

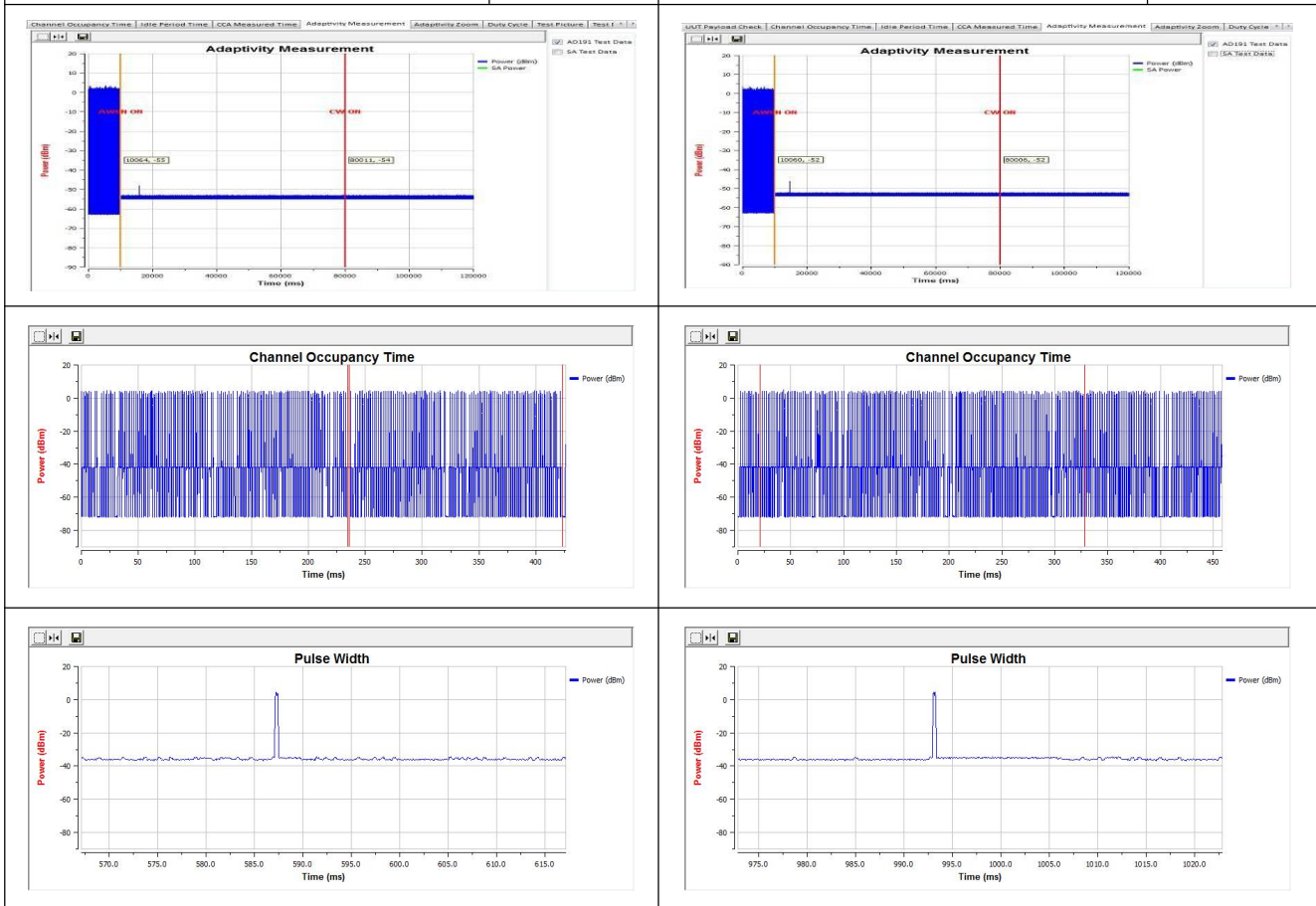

Note:

During the test, the signal observed on the channel being investigated is the Short Control Signalling Transmissions.

6.6 Transmitter unwanted emissions in the spurious domain

6.6.1 Limit(ETSI EN 300 328 V2.2.2 (2019-07) Clause 4.3.2.9.3)

TRANSMITTER UNWANTED EMISSIONS IN THE SPURIOUS DOMAIN		
Frequency Range	Maximum Power Limit (E.R.P.(≤1 GHz) E.I.R.P.(> 1 GHz))	Bandwidth
30 MHz to 47 MHz	-36dBm	100 kHz
47 MHz to 74 MHz	-54dBm	100 kHz
74 MHz to 87.5 MHz	-36dBm	100 kHz
87.5 MHz to 118 MHz	-54dBm	100 kHz
118 MHz to 174 MHz	-36dBm	100 kHz
174 MHz to 230 MHz	-54dBm	100 kHz
230 MHz to 470 MHz	-36dBm	100 kHz
470 MHz to 694 MHz	-54dBm	100 kHz
694 MHz to 1GHz	-36dBm	100 kHz
1 GHz to 12.75 GHz	-30dBm	1 MHz

6.6.2 Test procedure

Refer to ETSI EN 300 328 V2.2.2 (2019-07) Clause 5.4.9

Measurement	
<input checked="" type="checkbox"/> Conducted measurement	<input checked="" type="checkbox"/> Radiated measurement

The setting of the Spectrum Analyzer

RBW	100K(<1GHz) / 1M(> 1GHz)
VBW	300K(<1GHz) / 3M(> 1GHz)

6.6.3 TEST SETUP

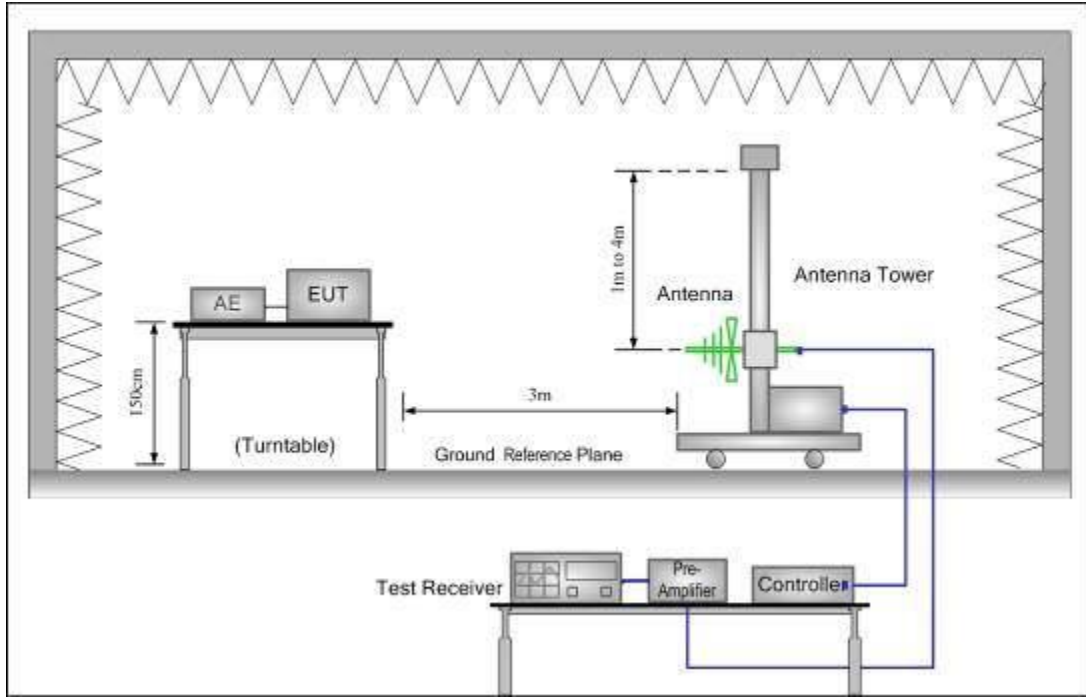

Figure 1. 30MHz to 1GHz

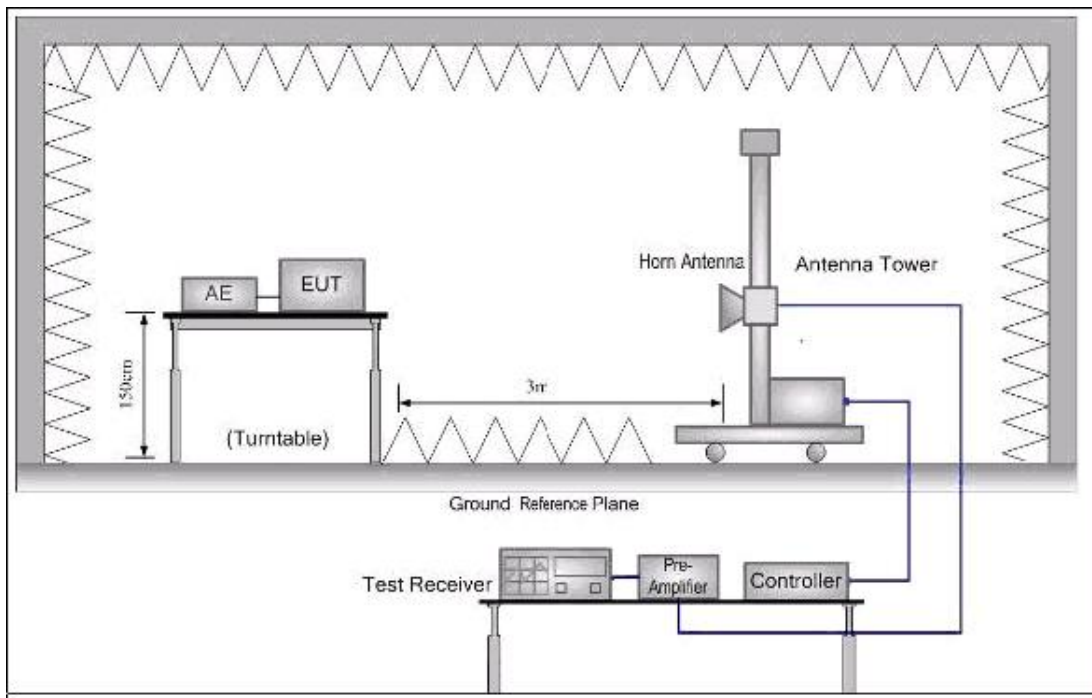

Figure 2. Above 1GHz

6.6.4 Radiated Test result

802.11b Lowest (2412 MHz)

below 1 GHz				
Maximum Frequency	Spurious Emission polarization and Level		Limit	Over Limit
MHz	polarization	dBm	dBm	dB
69.000	Vertical	-65.20	-54.00	-14.40
166.032	Vertical	-65.15	-36.00	-33.91
497.677	Vertical	-59.38	-54.00	-12.30
103.677	Horizontal	-61.10	-54.00	-8.93
215.484	Horizontal	-67.43	-36.00	-32.42
528.060	Horizontal	-69.36	-36.00	-30.49
Above 1 GHz				
Maximum Frequency	Spurious Emission polarization and Level		Limit	Over Limit
MHz	polarization	dBm	dBm	dB
4824.00	Vertical	-40.76	-30.00	-10.76
7236.00	Vertical	-46.51	-30.00	-16.51
9648.00	Vertical	-40.43	-30.00	-10.43
4944.00	Horizontal	-39.80	-30.00	-9.80
7416.00	Horizontal	-44.60	-30.00	-14.60
9888.00	Horizontal	-45.79	-30.00	-15.79

802.11b highest CH (2472 MHz)

below 1 GHz				
Maximum Frequency	Spurious Emission polarization and Level		Limit	Over Limit
MHz	polarization	dBm	dBm	dB
46.597	Vertical	-68.35	-36.00	-14.35
166.175	Vertical	-70.36	-36.00	-34.36
497.835	Vertical	-65.77	-54.00	-11.77
103.829	Horizontal	-62.84	-36.00	-8.84
216.092	Horizontal	-68.97	-36.00	-32.97
527.640	Horizontal	-65.78	-36.00	-29.78
Above 1 GHz				
Maximum Frequency	Spurious Emission polarization and Level		Limit	Over Limit
MHz	polarization	dBm	dBm	dB
4944.00	H	-41.07	-30.00	-11.07
7416.00	H	-46.89	-30.00	-16.89
9888.00	H	-40.13	-30.00	-10.13
4944.00	V	-39.77	-30.00	-9.77
7416.00	V	-45.00	-30.00	-15.00
9888.00	V	-45.57	-30.00	-15.57

Note: All the modes had been tested, but only the worst data recorded in the report.

6.6.5 Conducted Test result

For test data, please refer to the appendix results.

6.7 Receiver spurious emissions

6.7.1 Limit(ETSI EN 300 328 V2.2.2 (2019-07) Clause 4.3.2.10.3)

Spurious emission limits for receivers

Frequency range	Maximum power, e.r.p. (≤ 1 GHz) e.i.r.p. (> 1 GHz)	Bandwidth
30 MHz to 1 GHz	-57 dBm	100KHz
1 GHz to 12,75 GHz	-47 dBm	1MHz

6.7.2 Test Setup

Radiated measurement:

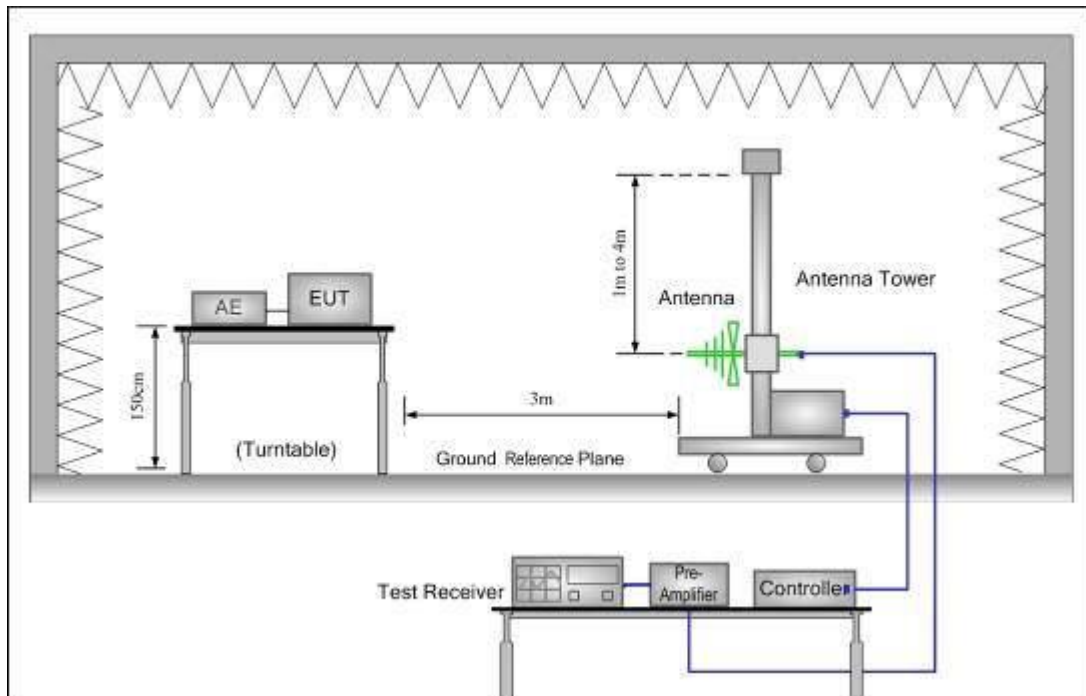

Figure 1. 30MHz to 1GHz

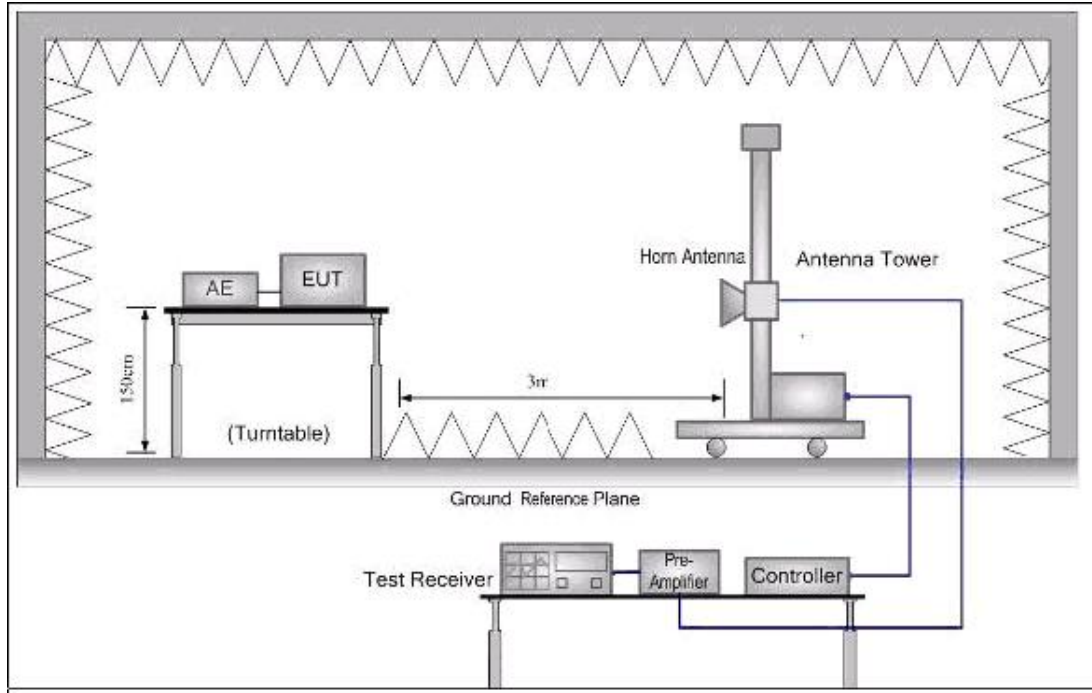
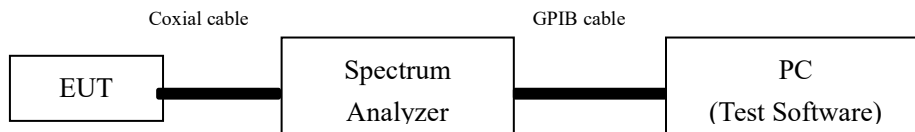

Figure 2. Above 1GHz

Conducted measurement:



1. For the actual test configuration, please refer to the related Item in this test report (Photographs of the Test Configuration).
2. Testing was performed when the equipment was in a receive-only mode.
3. The measurements were performed when normal hopping was disabled. In this case measurements were performed when operating at the lowest and the highest hopping frequency.
4. The test setup has been constructed as the normal use condition. Controlling software has been activated to set the EUT on specific status.

6.7.3 Test procedure

Refer to ETSI EN 300 328 V2.2.2 (2019-07) Clause 5.4.10

Measurement	
<input checked="" type="checkbox"/> Conducted measurement	<input checked="" type="checkbox"/> Radiated measurement

The setting of the Spectrum Analyzer

RBW	100K(<1GHz) / 1M(>1GHz)
VBW	300K(<1GHz) / 3M(>1GHz)

6.7.4 Test Result(Radiated measurement)

802.11b low CH (2412 MHz)

below 1 GHz				
Maximum Frequency	Spurious Emission polarization and Level		Limit	Over Limit
	MHz	polarization		
230.89	Vertical	-65.38	-57.00	-8.38
1471.05	Vertical	-65.66	-57.00	-8.66
3152.97	Vertical	-63.89	-57.00	-6.89
359.24	Horizontal	-64.99	-57.00	-7.99
1825.01	Horizontal	-63.91	-57.00	-6.91
3179.04	Horizontal	-65.69	-57.00	-8.69
Above 1 GHz				
Maximum Frequency	Spurious Emission polarization and Level		Limit	Over Limit
	MHz	polarization		
1604.64	Vertical	-65.11	-47.00	-18.11
2818.02	Vertical	-65.16	-47.00	-18.16
5191.82	Vertical	-63.84	-47.00	-16.84
2085.29	Horizontal	-64.97	-47.00	-17.97
2755.60	Horizontal	-63.49	-47.00	-16.49
4902.09	Horizontal	-65.91	-47.00	-18.91

802.11b High CH (2472 MHz)

below 1 GHz				
Maximum Frequency	Spurious Emission polarization and Level		Limit of	Over Limit
MHz	polarization	dBm	dBm	dB
72.06	Vertical	-65.15	-57.00	-8.15
1470.84	Vertical	-65.07	-57.00	-8.07
3152.75	Vertical	-63.22	-57.00	-6.22
358.63	Horizontal	-65.19	-57.00	-8.19
1825.25	Horizontal	-63.37	-57.00	-6.37
3178.45	Horizontal	-65.64	-57.00	-8.64
Above 1 GHz				
Maximum Frequency	Spurious Emission polarization and Level		Limit	Over Limit
MHz	polarization	dBm	dBm	dB
1533.24	Vertical	-64.50	-47.00	-17.50
2817.40	Vertical	-65.14	-47.00	-18.14
5192.35	Vertical	-63.28	-47.00	-16.28
2085.02	Horizontal	-64.97	-47.00	-17.97
2755.88	Horizontal	-64.08	-47.00	-17.08
4902.52	Horizontal	-66.07	-47.00	-19.07

Test Result (Conducted measurement)

For test data, please refer to the appendix results.

6.8 Receiver Blocking

6.8.1 Performance Criteria

The minimum performance criterion shall be a PER less than or equal to 10 %. The manufacturer may declare alternative performance criteria as long as that is appropriate for the intended use of the equipment (see clause 5.4.1.t)).

6.8.2 Test procedure

Refer to ETSI EN 300 328 V2.2.2 (2019-07) Clause 5.4.11.2

Measurement	
<input checked="" type="checkbox"/> Conducted measurement	<input type="checkbox"/> Radiated measurement

6.8.3 Limit(ETSI EN 300 328 V2.2.2 (2019-07) Clause 4.3.2.11.4)

While maintaining the minimum performance criteria as defined in clause 4.3.1.12.3, the blocking levels at specified frequency offsets shall be equal to or greater than the limits defined for the applicable receiver category provided in table 6, table 7 or table 8.

Receiver Category 1

Table 6: Receiver Blocking parameters for Receiver Category 1 equipment

Wanted signal mean power from companion device (dBm) (see notes 1 and 4)	Blocking signal frequency (MHz)	Blocking signal power (dBm) (see note 4)	Type of blocking signal
$(-133 \text{ dBm} + 10 \times \log_{10}(\text{OCBW}))$ or -68 dBm whichever is less (see note 2)	2 380 2 504	-34	CW
$(-139 \text{ dBm} + 10 \times \log_{10}(\text{OCBW}))$ or -74 dBm whichever is less (see note 3)	2 300 2 330 2 360 2 524 2 584 2 674		

NOTE 1: OCBW is in Hz.

NOTE 2: In case of radiated measurements using a companion device and the level of the wanted signal from the companion device cannot be determined, a relative test may be performed using a wanted signal up to $P_{\text{min}} + 26 \text{ dB}$ where P_{min} is the minimum level of wanted signal required to meet the minimum performance criteria as defined in clause 4.3.1.12.3 in the absence of any blocking signal.

NOTE 3: In case of radiated measurements using a companion device and the level of the wanted signal from the companion device cannot be determined, a relative test may be performed using a wanted signal up to $P_{\text{min}} + 20 \text{ dB}$ where P_{min} is the minimum level of wanted signal required to meet the minimum performance criteria as defined in clause 4.3.1.12.3 in the absence of any blocking signal.

NOTE 4: The level specified is the level at the UUT receiver input assuming a 0 dBi antenna assembly gain. In case of conducted measurements, this level has to be corrected for the (in-band) antenna assembly gain (G). In case of radiated measurements, this level is equivalent to a power flux density (PFD) in front of the UUT antenna with the UUT being configured/positioned as recorded in clause 5.4.3.2.2.

Receiver Category 2

Table 7: Receiver Blocking parameters receiver Category 2 equipment

Wanted signal mean power from companion device (dBm) (see notes 1 and 3)	Blocking signal frequency (MHz)	Blocking signal power (dBm) (see note 3)	Type of blocking signal
$(-139 \text{ dBm} + 10 \times \log_{10}(\text{OCBW}) + 10 \text{ dB})$ or $(-74 \text{ dBm} + 10 \text{ dB})$ whichever is less (see note 2)	2 380 2 504 2 300 2 584	-34	CW
<p>NOTE 1: OCBW is in Hz.</p> <p>NOTE 2: In case of radiated measurements using a companion device and the level of the wanted signal from the companion device cannot be determined, a relative test may be performed using a wanted signal up to $P_{\text{min}} + 26 \text{ dB}$ where P_{min} is the minimum level of wanted signal required to meet the minimum performance criteria as defined in clause 4.3.1.12.3 in the absence of any blocking signal.</p> <p>NOTE 3: The level specified is the level at the UUT receiver input assuming a 0 dBi antenna assembly gain. In case of conducted measurements, this level has to be corrected for the (in-band) antenna assembly gain (G). In case of radiated measurements, this level is equivalent to a power flux density (PFD) in front of the UUT antenna with the UUT being configured/positioned as recorded in clause 5.4.3.2.2.</p>			

Receiver Category 3

Table 8: Receiver Blocking parameters receiver Category 3 equipment

Wanted signal mean power from companion device (dBm) (see notes 1 and 3)	Blocking signal frequency (MHz)	Blocking signal power (dBm) (see note 3)	Type of blocking Signal
$(-139 \text{ dBm} + 10 \times \log_{10}(\text{OCBW}) + 20 \text{ dB})$ or $(-74 \text{ dBm} + 20 \text{ dB})$ whichever is less (see note 2)	2 380 2 504 2 300 2 584	-34	CW
<p>NOTE 1: OCBW is in Hz.</p> <p>NOTE 2: In case of radiated measurements using a companion device and the level of the wanted signal from the companion device cannot be determined, a relative the test may be performed using a wanted signal up to $P_{\text{min}} + 30 \text{ dB}$ where P_{min} is the minimum level of wanted signal required to meet the minimum performance criteria as defined in clause 4.3.1.12.3 in the absence of any blocking signal.</p> <p>NOTE 3: The level specified is the level at the UUT receiver input assuming a 0 dBi antenna assembly gain. In case of conducted measurements, this level has to be corrected for the (in-band) antenna assembly gain (G). In case of radiated measurements, this level is equivalent to a power flux density (PFD) in front of the UUT antenna with the UUT being configured/positioned as recorded in clause 5.4.3.2.2.</p>			

6.8.4 Test Setup

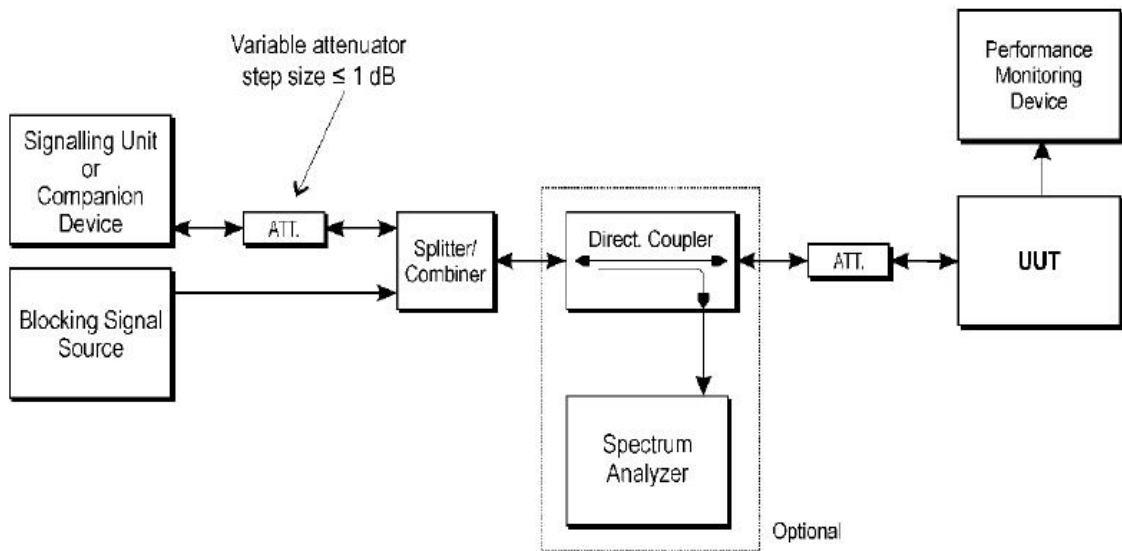

6.8.5 Test Result

Note: The power more than 10dBm, belong to category 1.

For test data, please refer to the appendix results.

7 Appendix test data

Appendix A. RF Output Power (E.I.R.P.)

Measurement Data:

Test Data of RF Output Power					
Test Mode	RF Output Power [dBm]			Limit [dBm]	Verdict
	NT	LT	HT		
11b_TX_2412_1Mbps	13.24	13.24	12.52	20	Pass
11b_TX_2442_1Mbps	14.78	14.78	14.37	20	Pass
11b_TX_2472_1Mbps	13.09	13.09	12.89	20	Pass
11g_TX_2412_6Mbps	12.1	12.1	11.90	20	Pass
11g_TX_2442_6Mbps	14.09	14.09	13.48	20	Pass
11g_TX_2472_6Mbps	11.6	11.6	10.71	20	Pass
11n20_TX_2412_MCS0	12.05	12.05	11.13	20	Pass
11n20_TX_2442_MCS0	14.08	14.08	14.01	20	Pass
11n20_TX_2472_MCS0	11.64	11.64	10.98	20	Pass
11n40_TX_2422_MCS0	11.69	11.69	11.10	20	Pass
11n40_TX_2442_MCS0	13.58	13.58	13.07	20	Pass
11n40_TX_2462_MCS0	12.03	12.03	11.27	20	Pass

Appendix B. Power Spectral Density

Measurement Data:

Test Data of Power Spectral Density			
Test Mode	Power Spectral Density [dBm/MHz]	Limit [dBm/MHz]	Verdict
11b_TX_2412_1Mbps	4.36	10	Pass
11b_TX_2442_1Mbps	5.87	10	Pass
11b_TX_2472_1Mbps	4.12	10	Pass
11g_TX_2412_6Mbps	0.81	10	Pass
11g_TX_2442_6Mbps	2.68	10	Pass
11g_TX_2472_6Mbps	-0.02	10	Pass
11n20_TX_2412_MCS0	0.65	10	Pass
11n20_TX_2442_MCS0	2.55	10	Pass
11n20_TX_2472_MCS0	-0.16	10	Pass
11n40_TX_2422_MCS0	-3.03	10	Pass
11n40_TX_2442_MCS0	-0.87	10	Pass
11n40_TX_2462_MCS0	-1.63	10	Pass

Test Graphs

PSD NVNT b 2412MHz Ant1

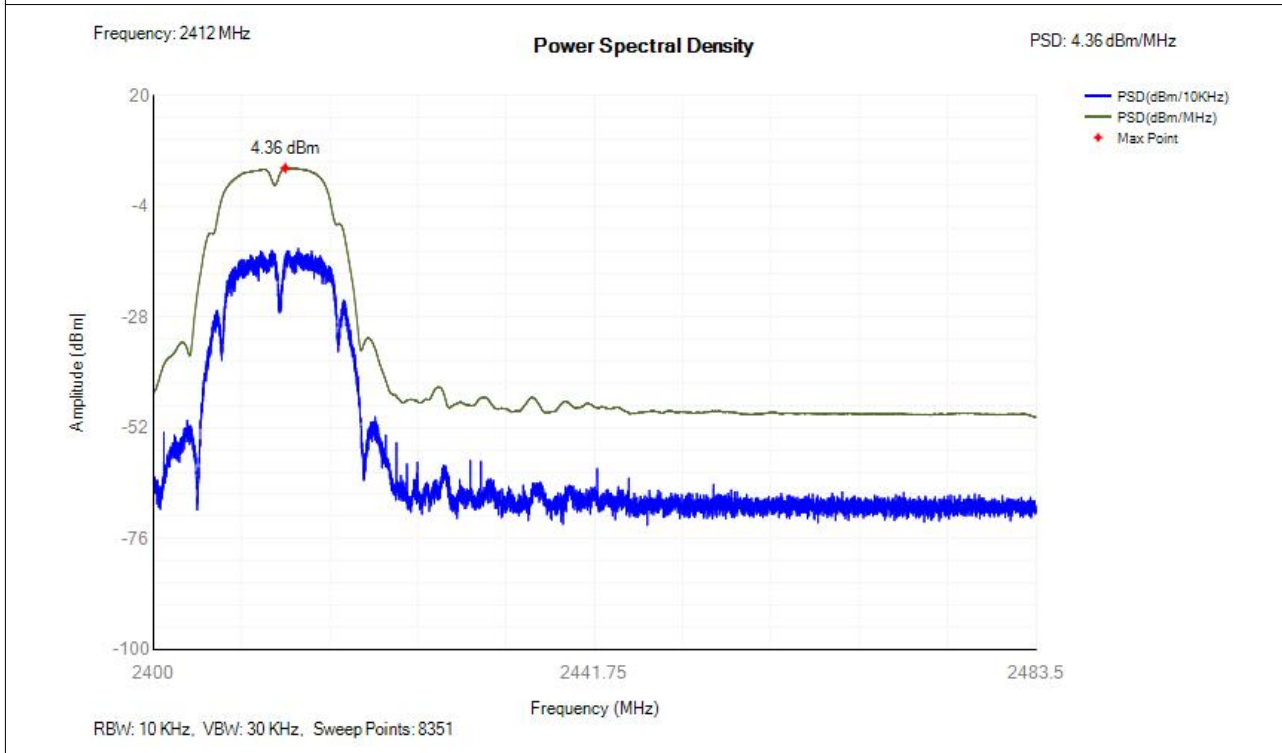

PSD NVNT b 2442MHz Ant1

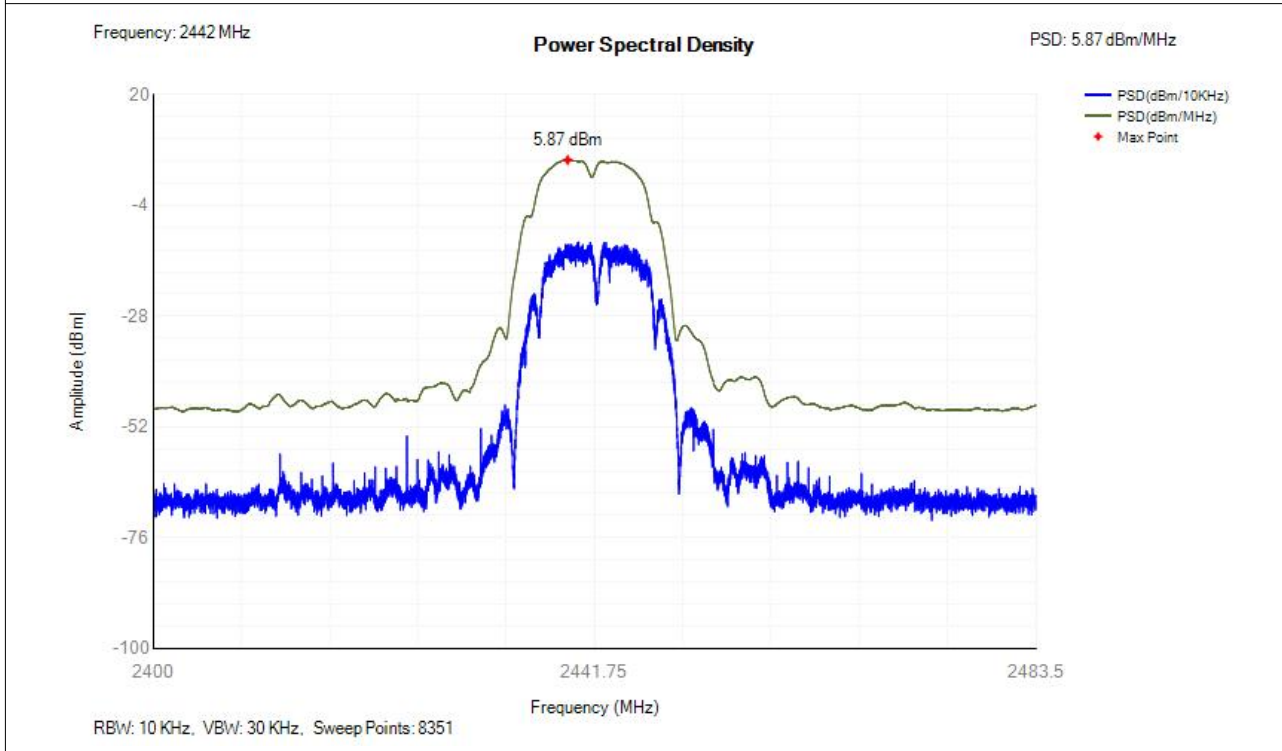

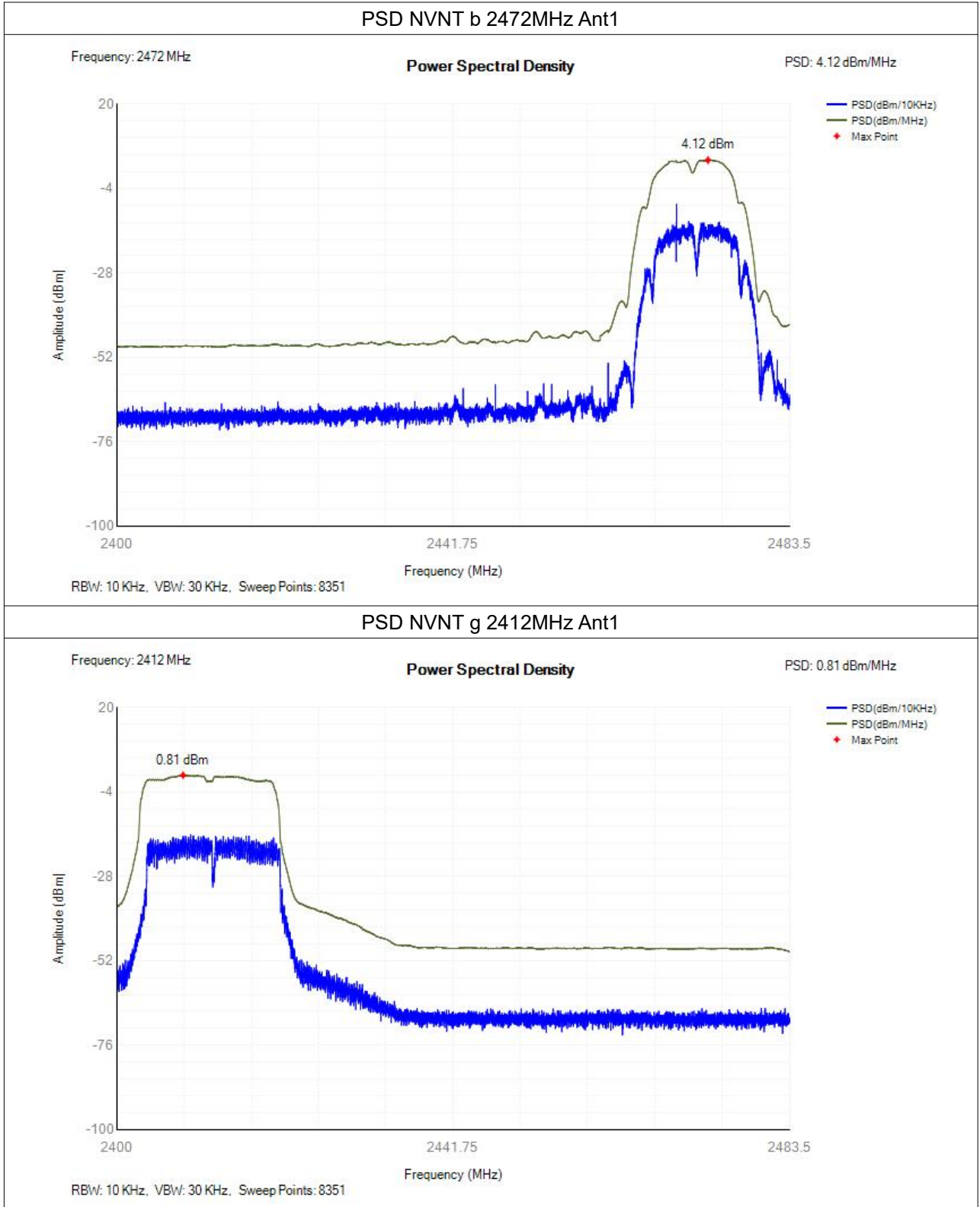

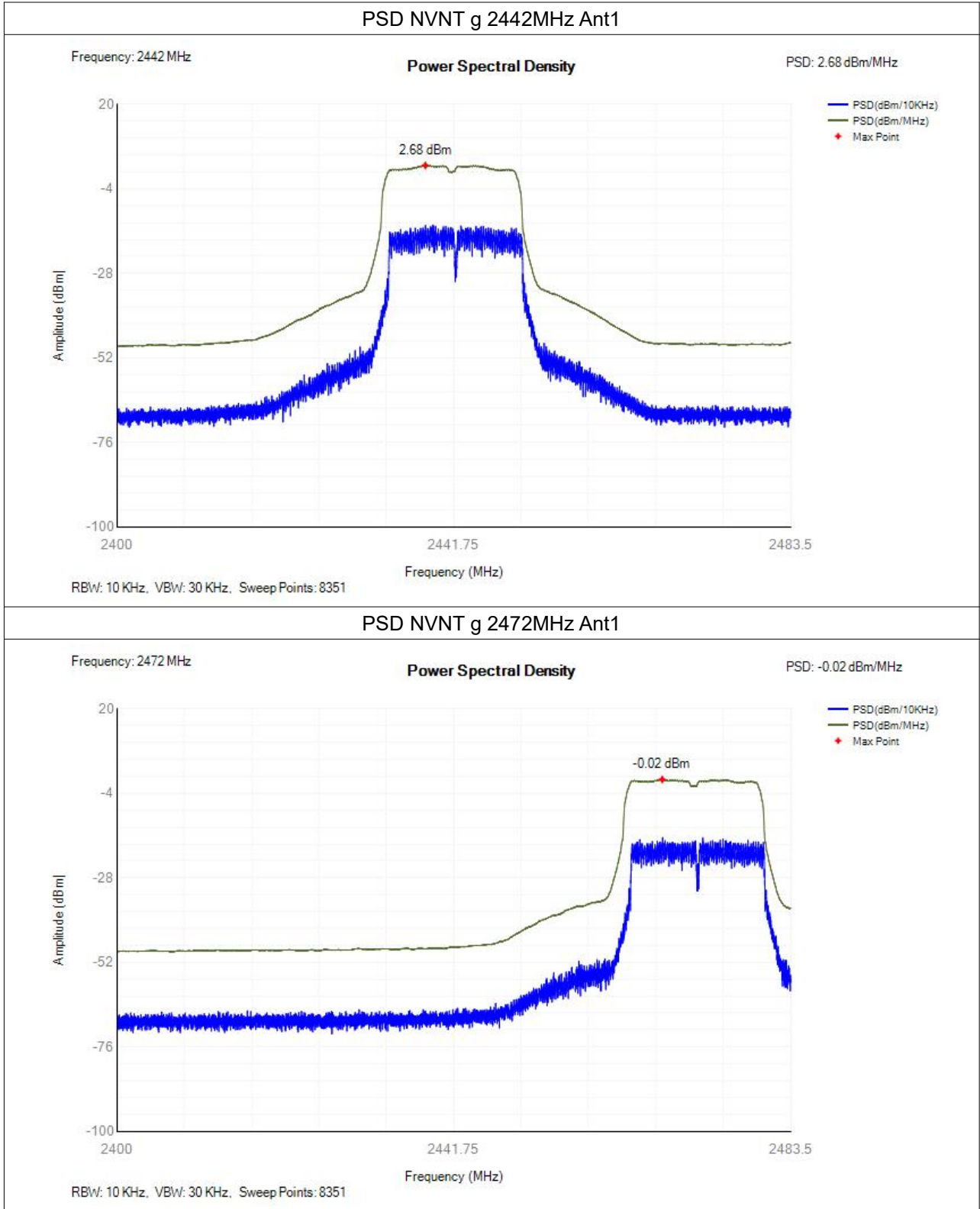

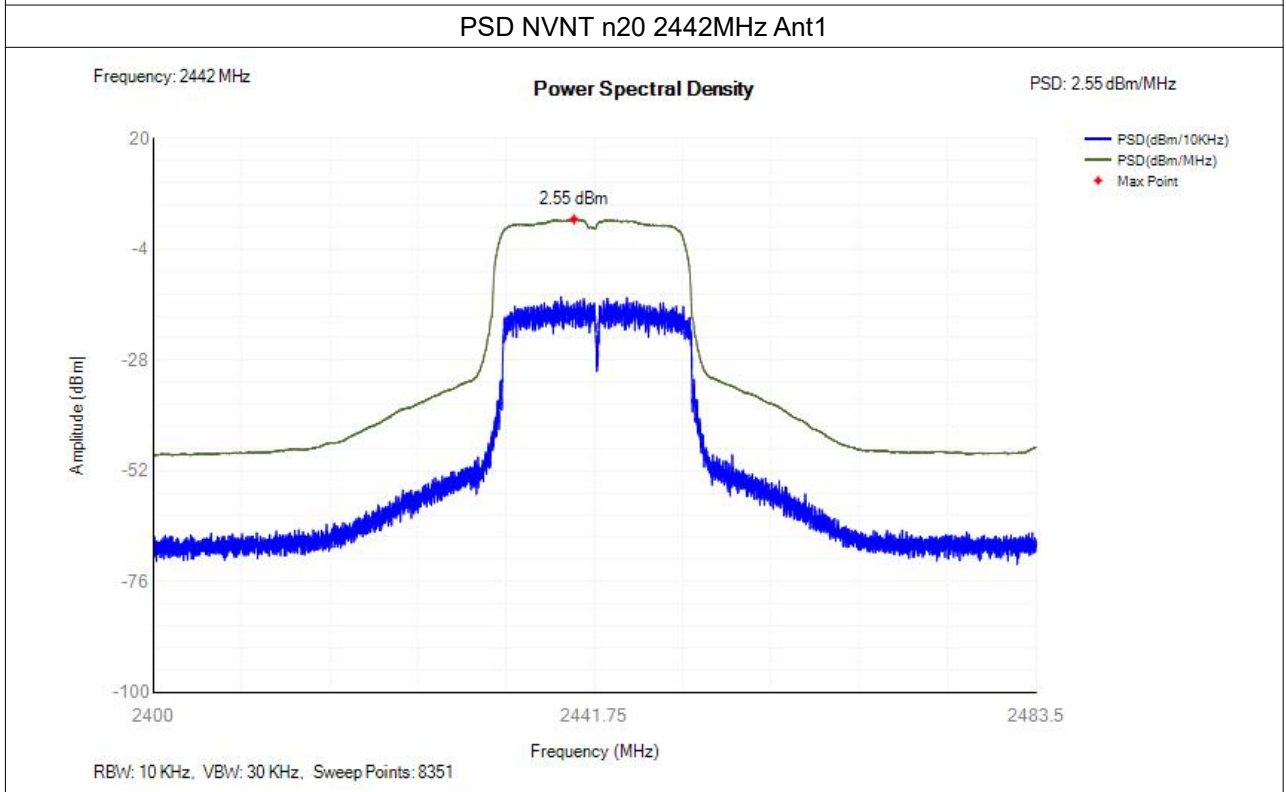
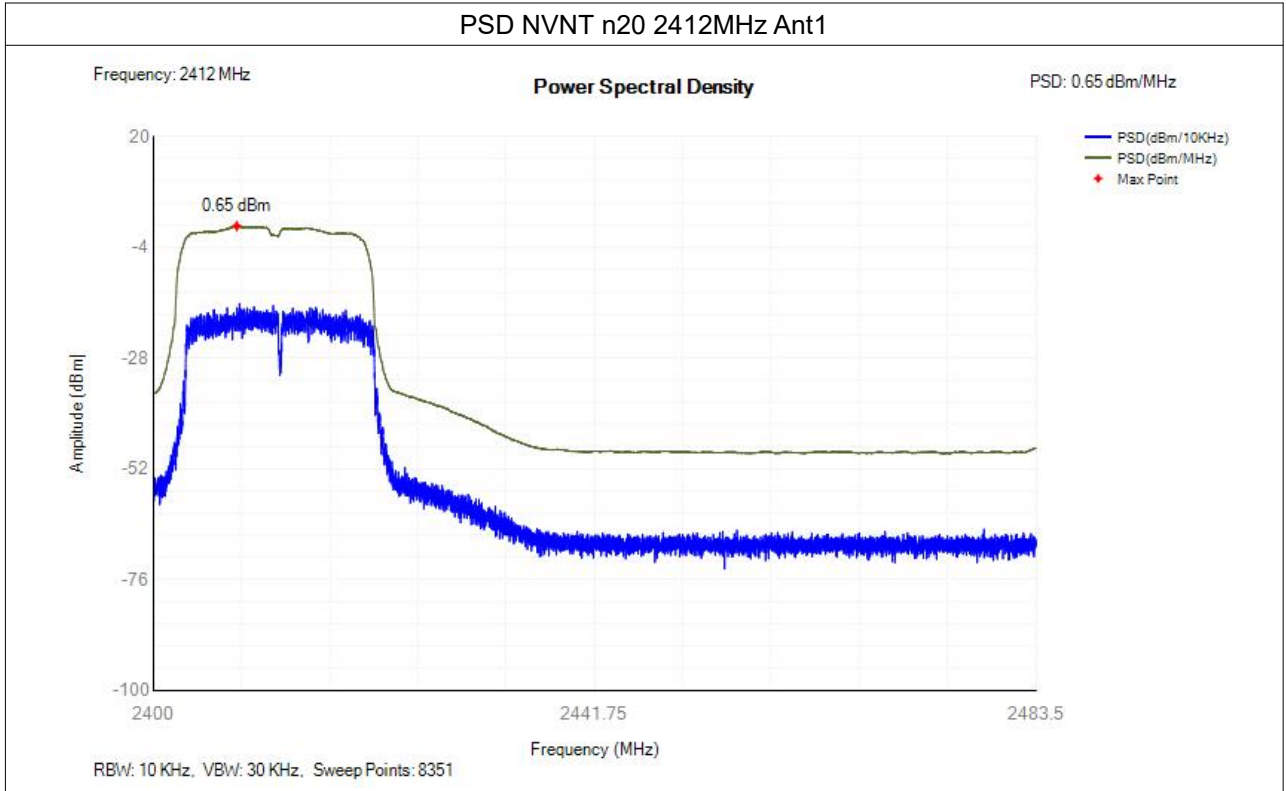

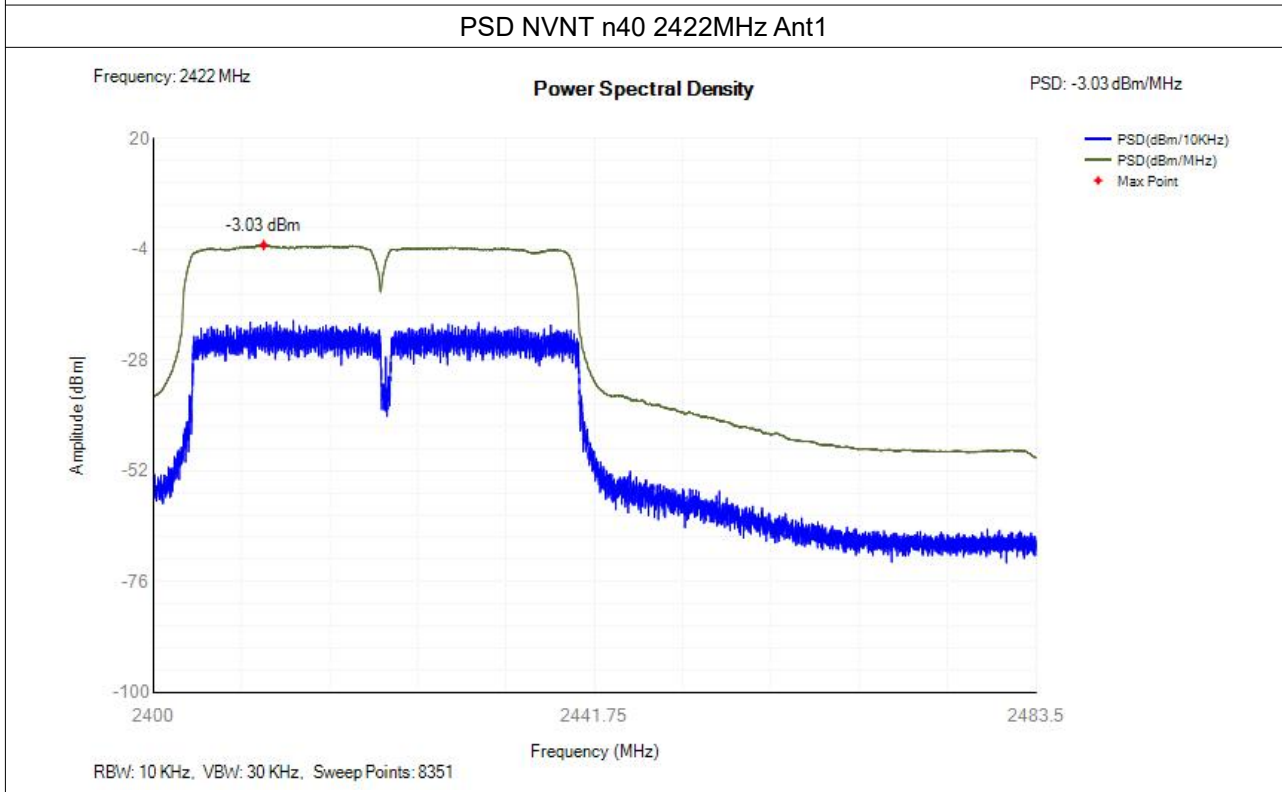
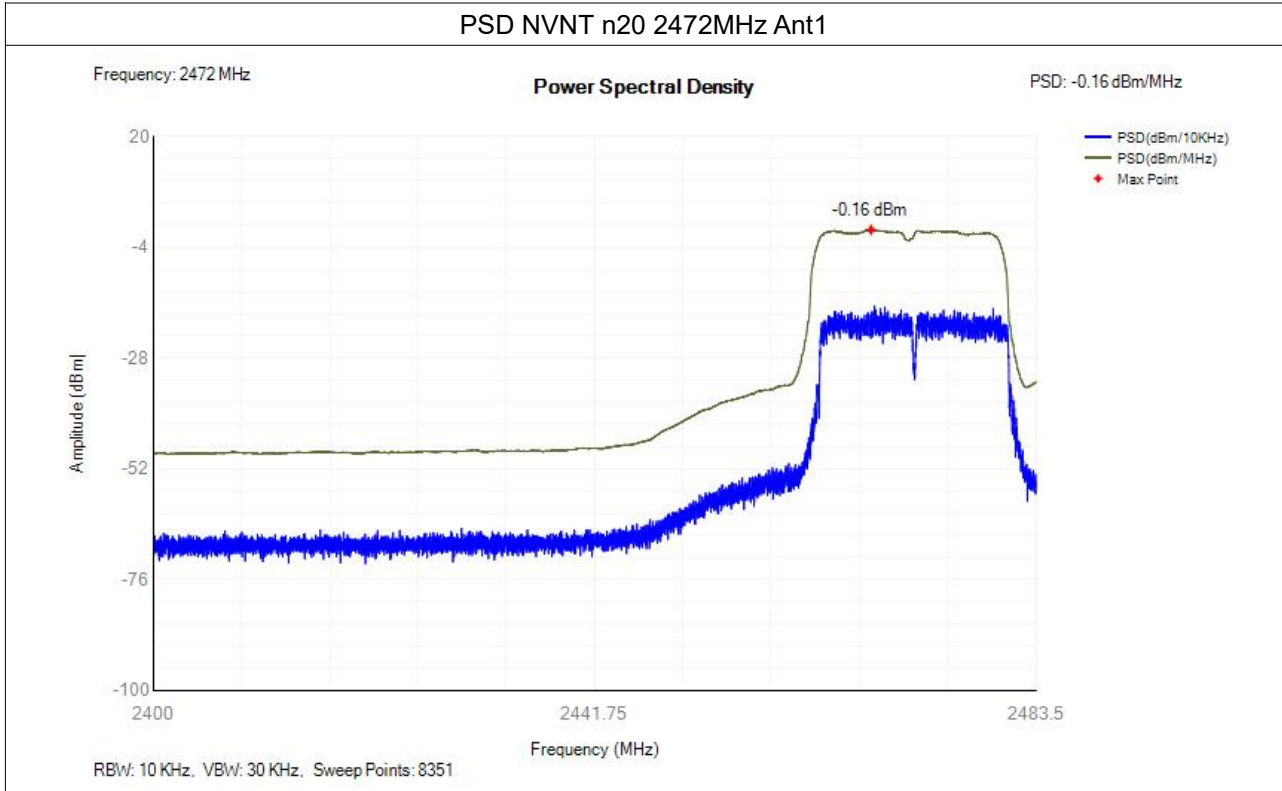

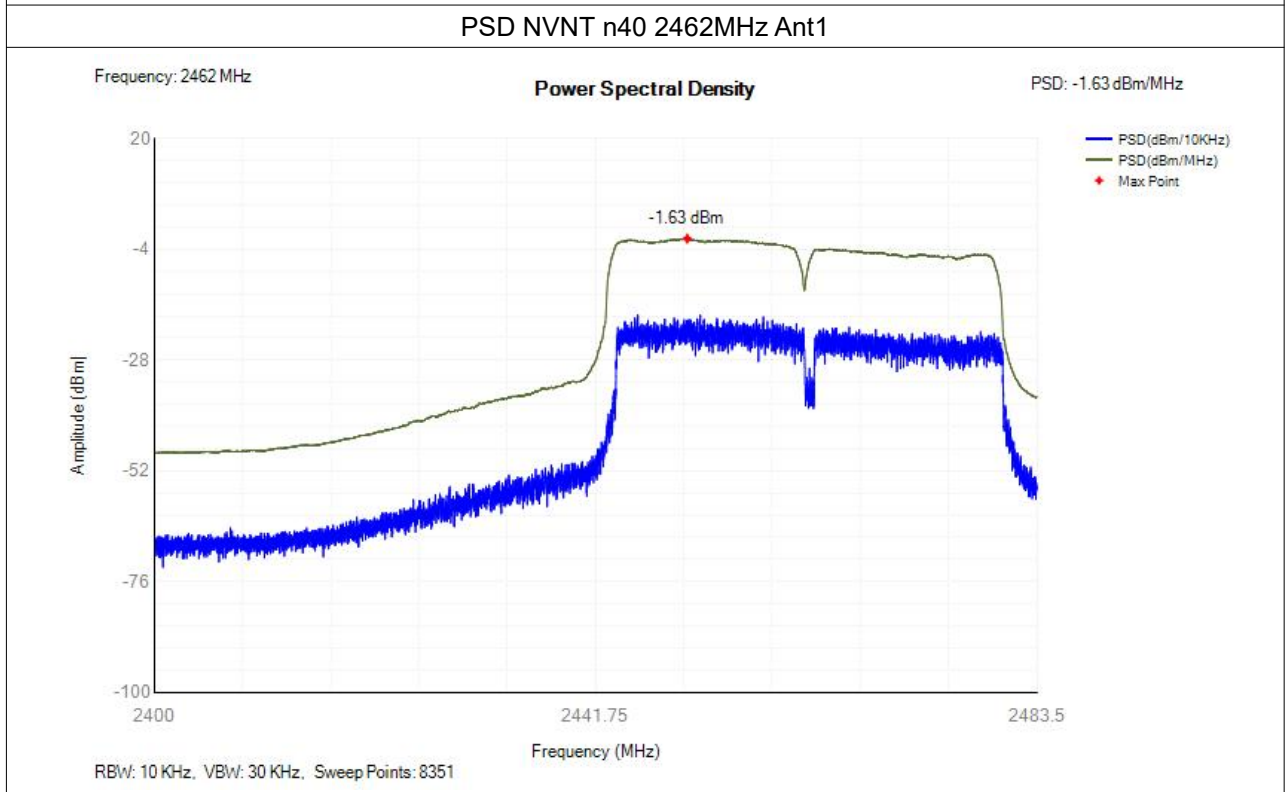
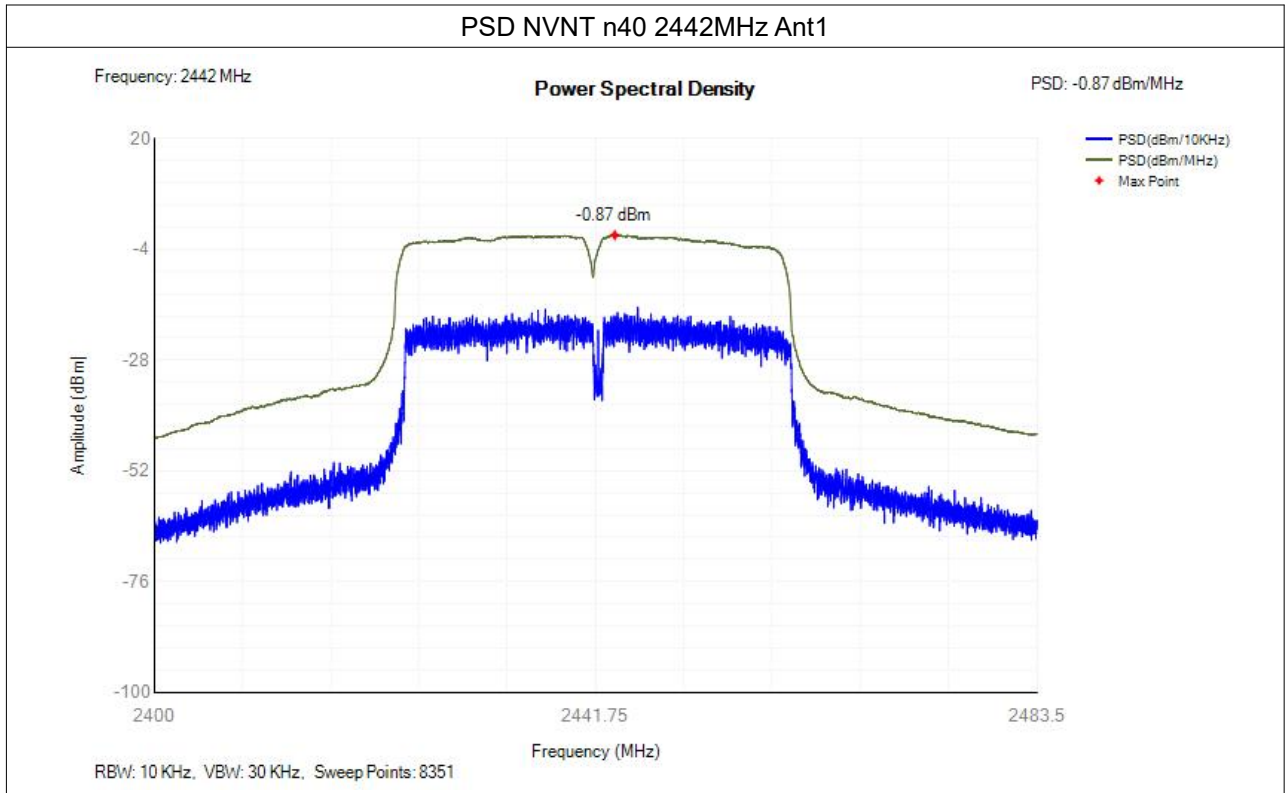

Appendix C. Occupied Channel Bandwidth

Measurement Data:

Test Data of Occupied Channel Bandwidth					
Test Mode	Occupied Channel Bandwidth [MHz]			Limit [MHz]	Verdict
	OCB	FL	FH		
11b_TX_2412_1Mbps	11.855	2406.213	2418.067	2400 to 2483.5	Pass
11b_TX_2472_1Mbps	11.939	2466.129	2478.067	2400 to 2483.5	Pass
11g_TX_2412_6Mbps	16.55	2403.705	2420.255	2400 to 2483.5	Pass
11g_TX_2472_6Mbps	16.634	2463.669	2480.303	2400 to 2483.5	Pass
11n20_TX_2412_MCS0	17.614	2403.173	2420.787	2400 to 2483.5	Pass
11n20_TX_2472_MCS0	17.714	2463.129	2480.843	2400 to 2483.5	Pass
11n40_TX_2422_MCS0	36.34	2403.81	2440.15	2400 to 2483.5	Pass
11n40_TX_2462_MCS0	36.372	2443.658	2480.03	2400 to 2483.5	Pass

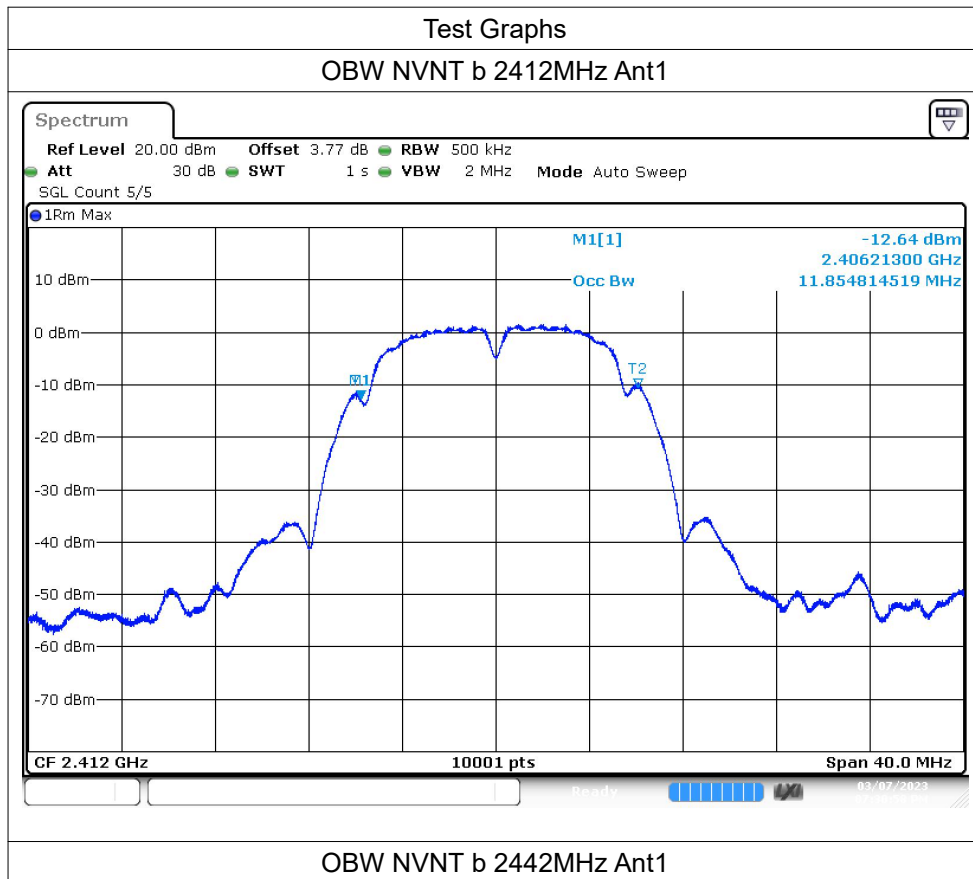

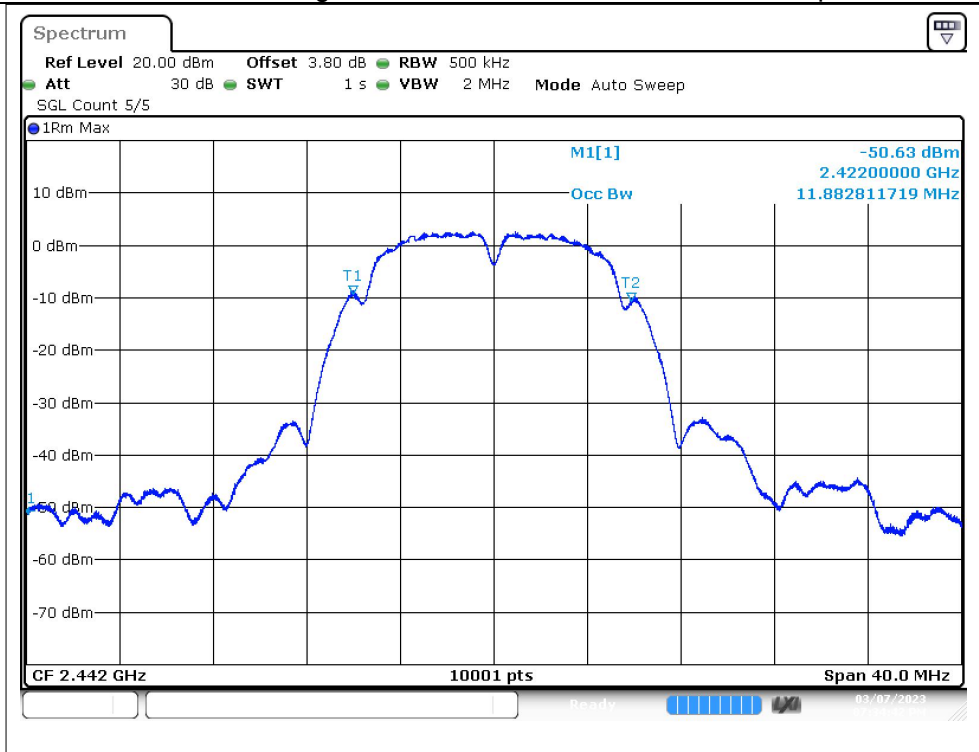

OBW NVNT b 2472MHz Ant1

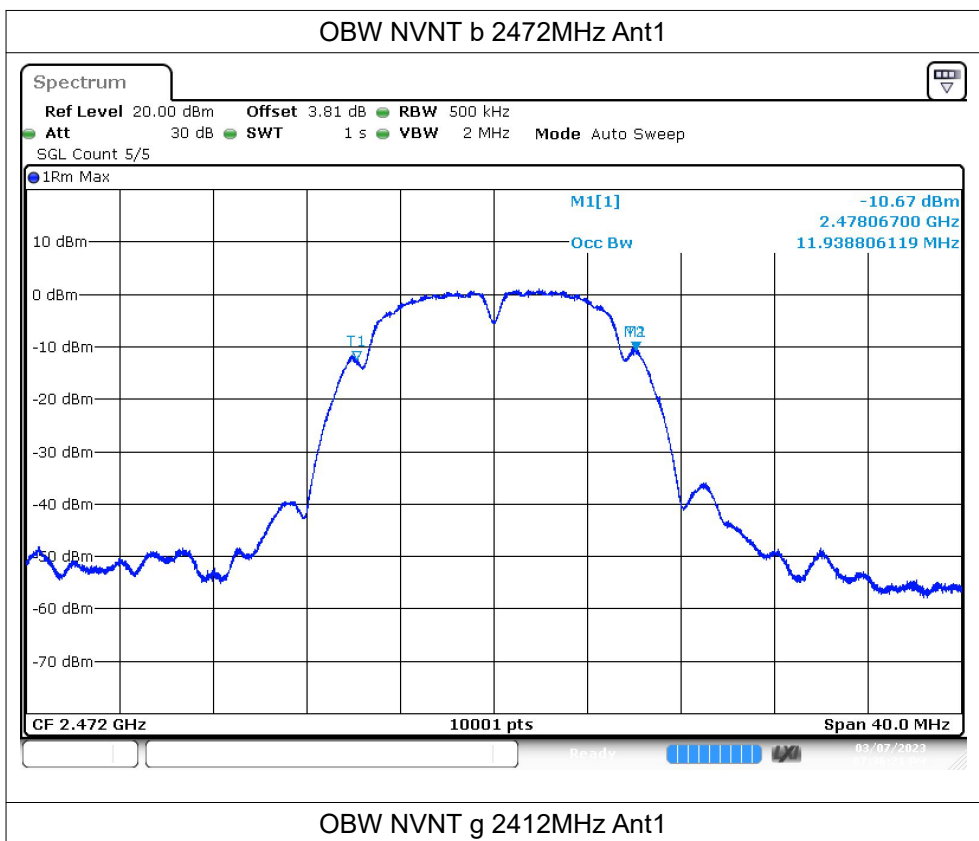

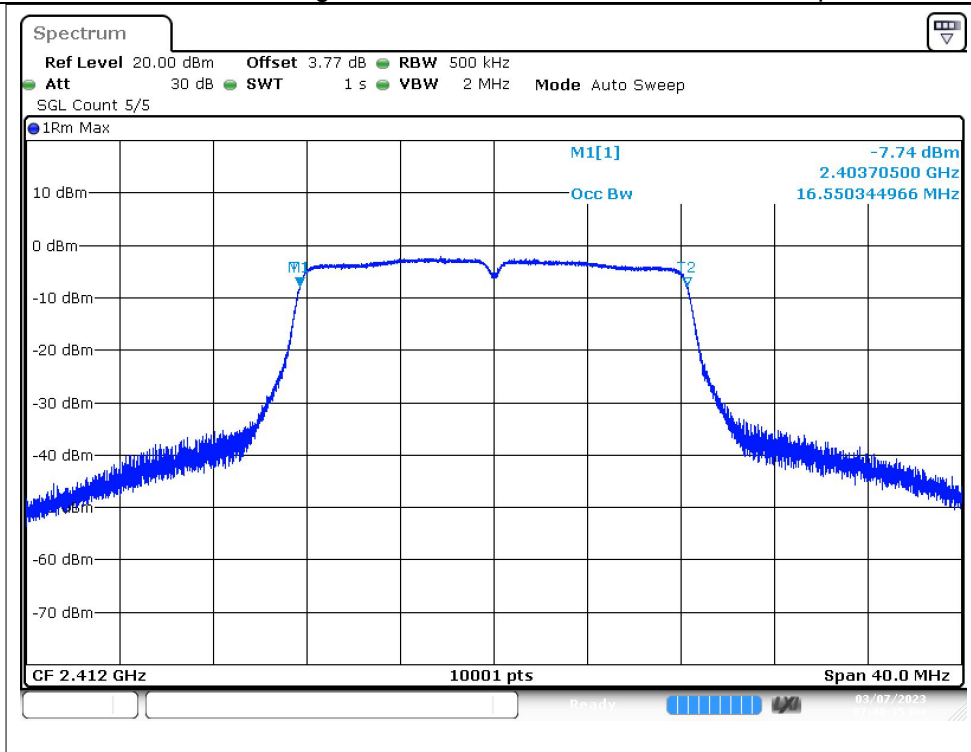

OBW NVNT g 2442MHz Ant1

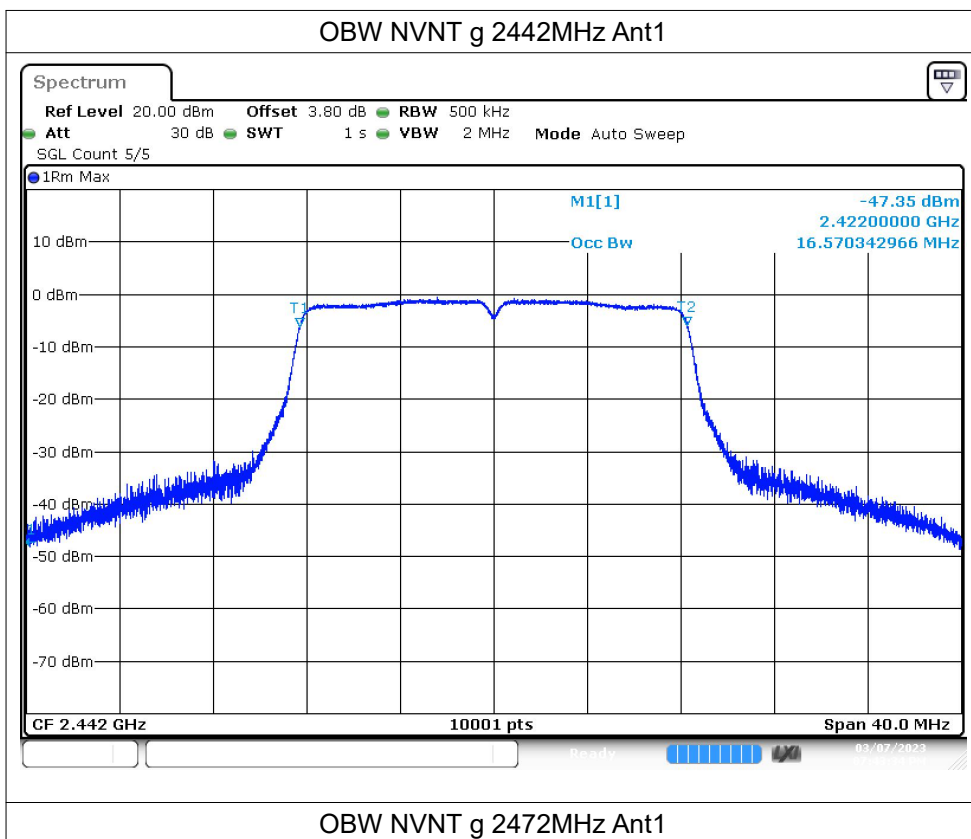

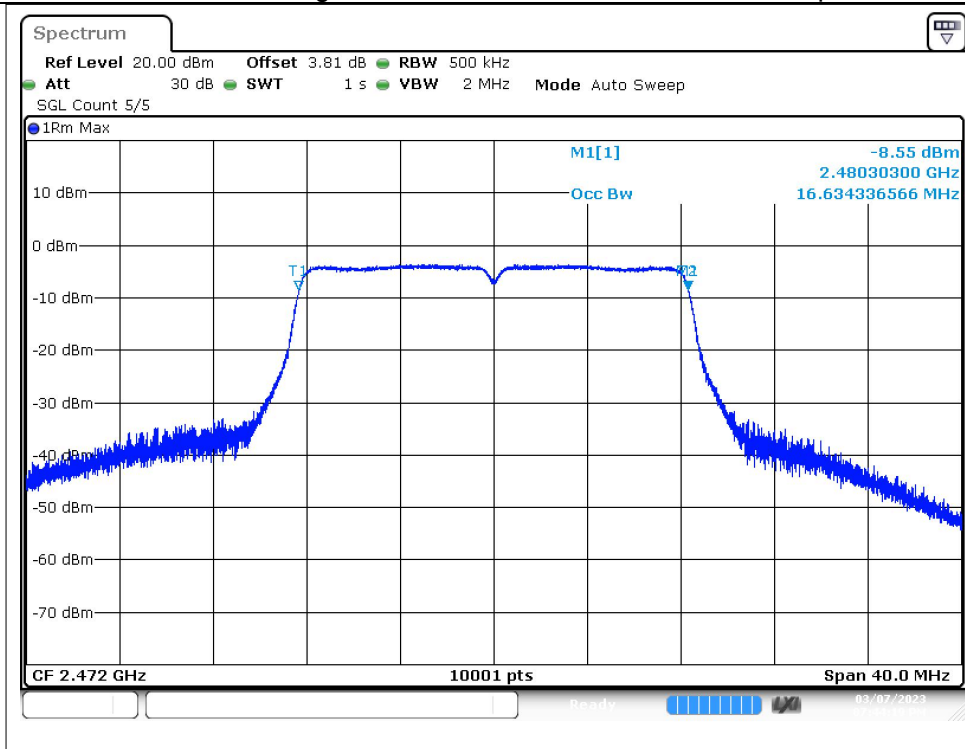

OBW NVNT n20 2412MHz Ant1

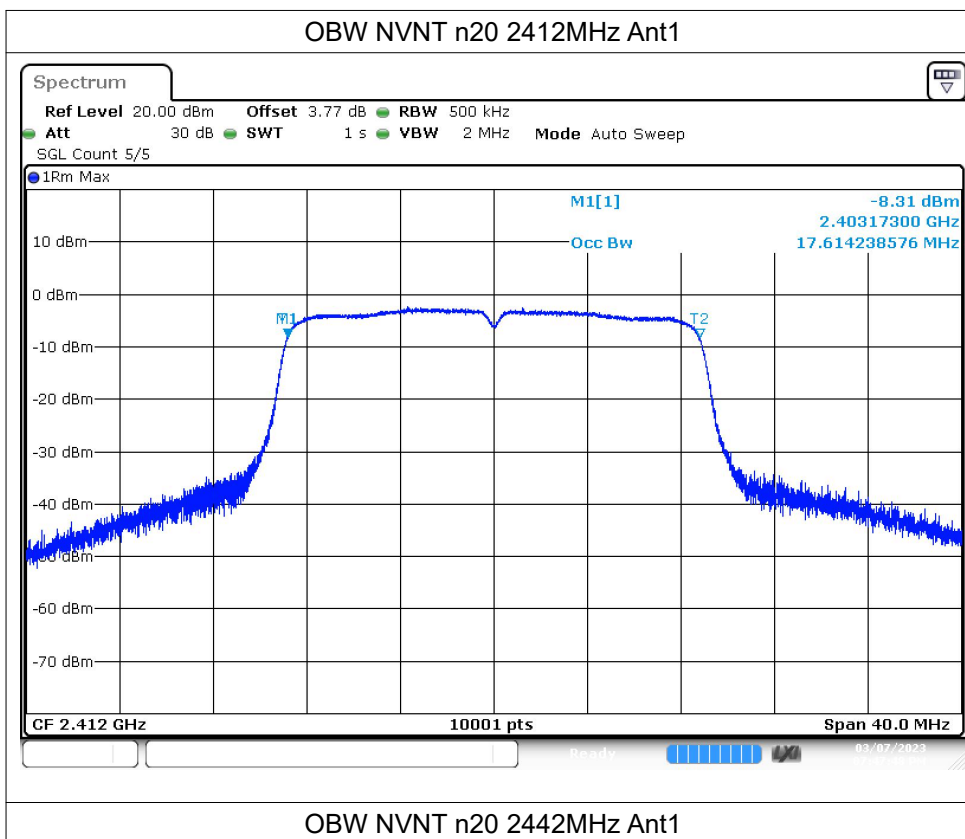

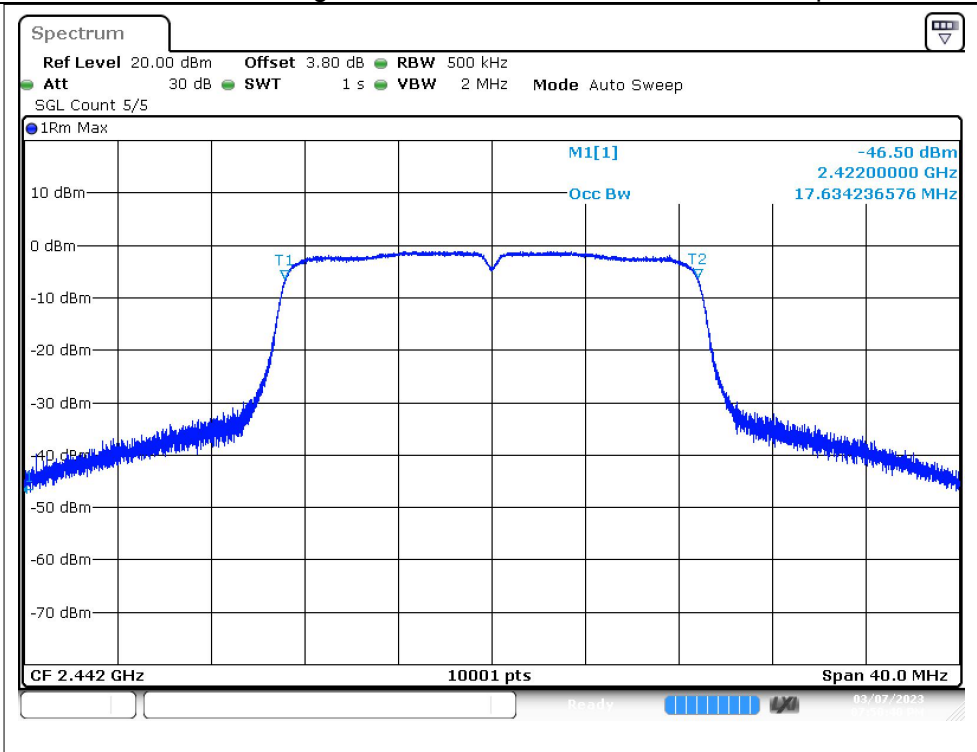

OBW NVNT n20 2472MHz Ant1

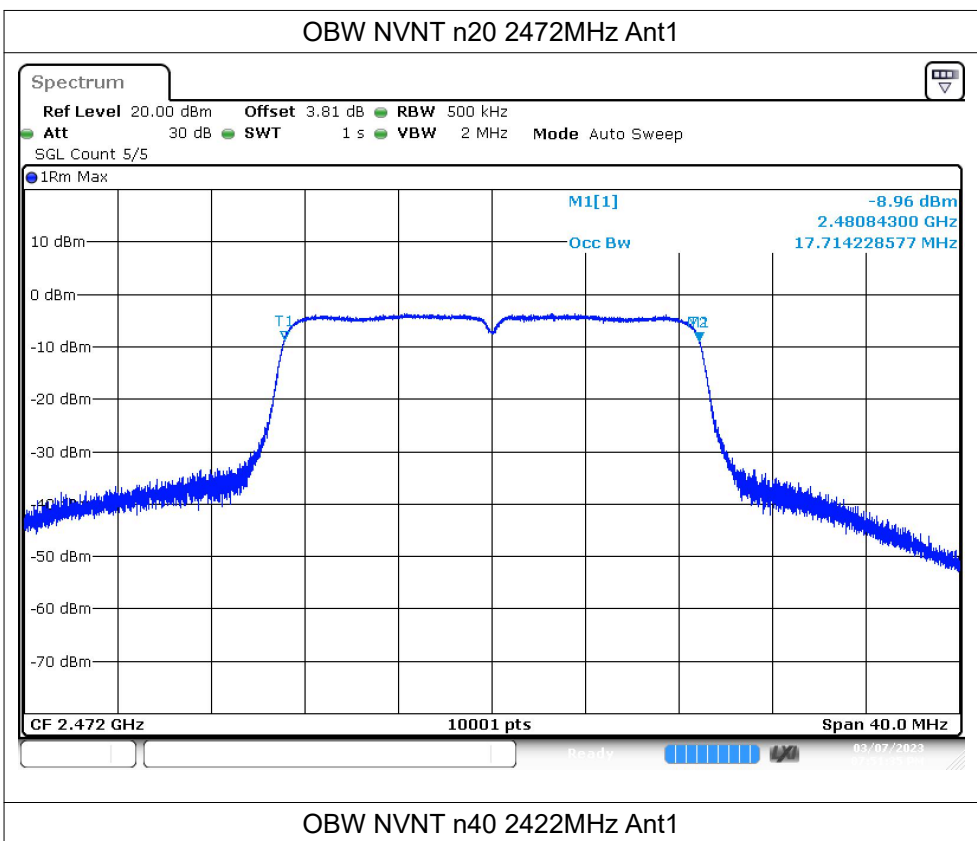

OBW NVNT n40 2422MHz Ant1

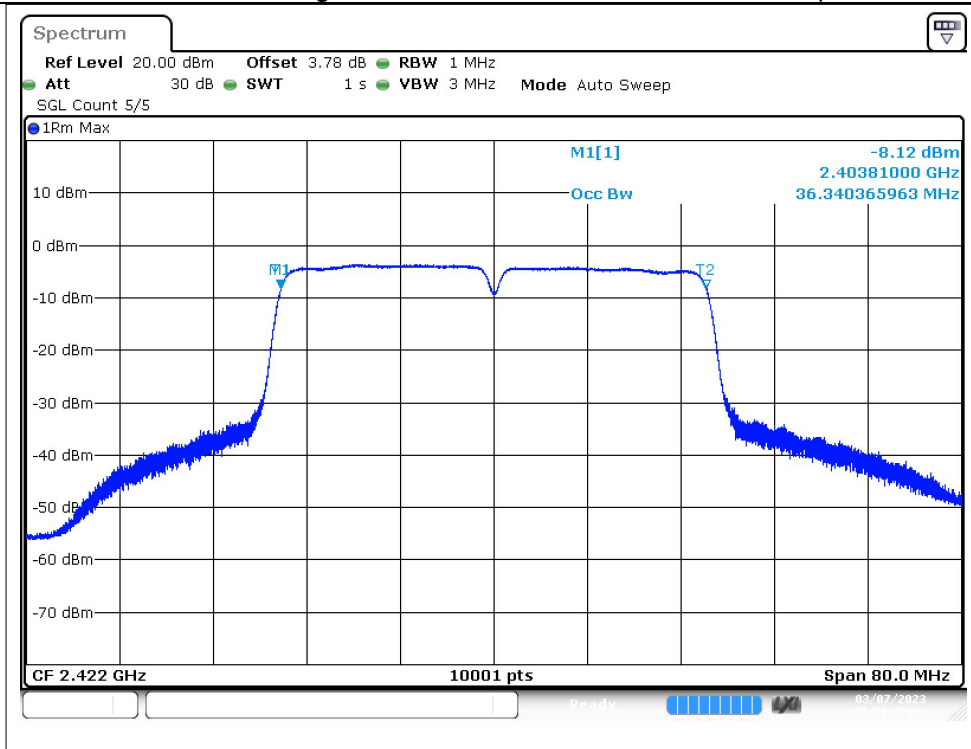

OBW NVNT n40 2442MHz Ant1

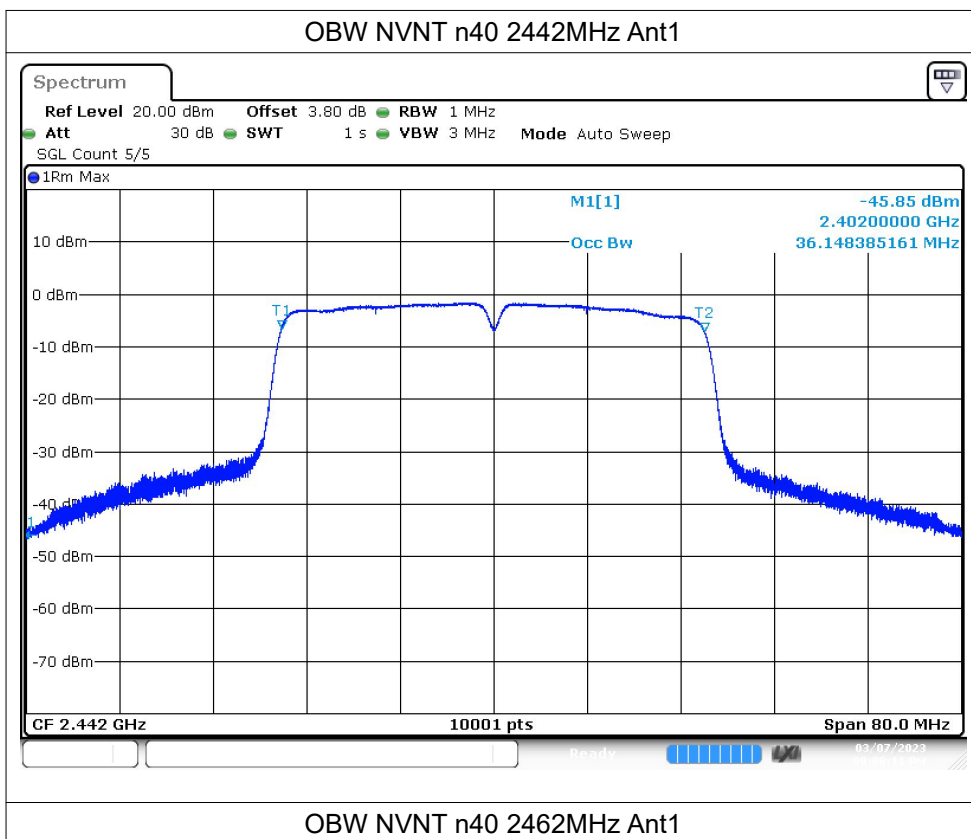

OBW NVNT n40 2462MHz Ant1

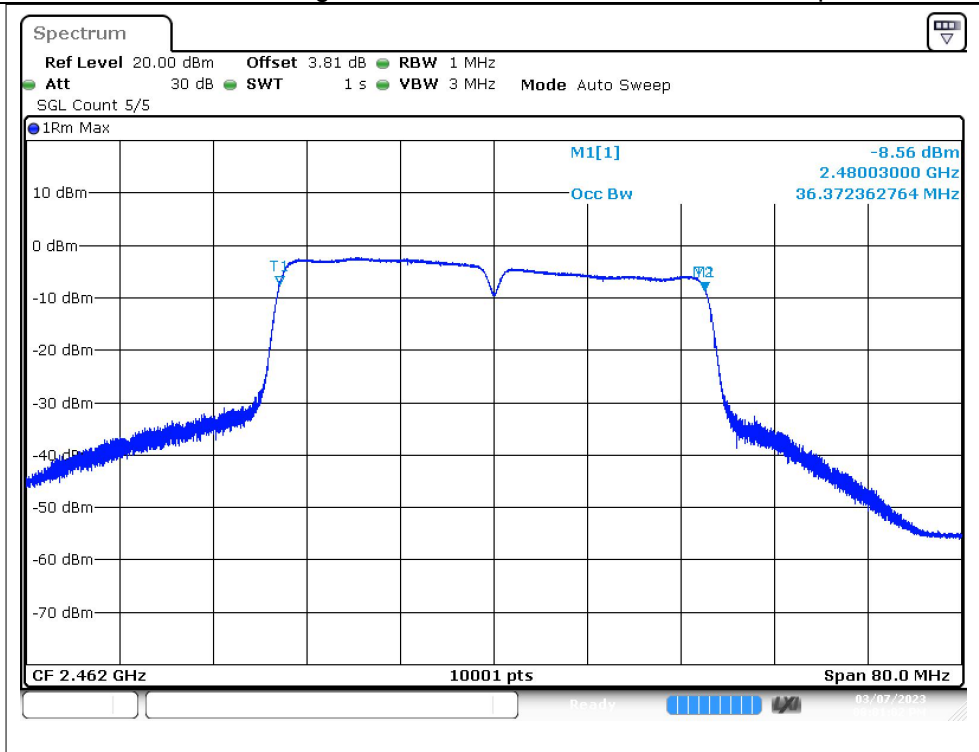

Appendix D. Transmitter unwanted emissions in the OOB domain

Measurement Data:

Mode	Frequency (MHz)	Antenna	OOB Frequency (MHz)	Level (dBm/MHz)	Limit (dBm/MHz)	Verdict
11b	2412	Ant1	2399.5	-43.76	-10	Pass
11b	2412	Ant1	2398.5	-43.8	-10	Pass
11b	2412	Ant1	2397.5	-45.3	-10	Pass
11b	2412	Ant1	2396.5	-47.94	-10	Pass
11b	2412	Ant1	2395.5	-46.81	-10	Pass
11b	2412	Ant1	2394.5	-46.22	-10	Pass
11b	2412	Ant1	2393.5	-48.64	-10	Pass
11b	2412	Ant1	2392.5	-48.4	-10	Pass
11b	2412	Ant1	2391.5	-46.58	-10	Pass
11b	2412	Ant1	2390.5	-49.47	-10	Pass
11b	2412	Ant1	2389.5	-50.18	-10	Pass
11b	2412	Ant1	2388.5	-53.78	-10	Pass
11b	2412	Ant1	2388.393	-53.85	-20	Pass
11b	2412	Ant1	2387.393	-54.4	-20	Pass
11b	2412	Ant1	2386.393	-56.26	-20	Pass
11b	2412	Ant1	2385.393	-57.17	-20	Pass
11b	2412	Ant1	2384.393	-57.68	-20	Pass
11b	2412	Ant1	2383.393	-57.59	-20	Pass
11b	2412	Ant1	2382.393	-58.12	-20	Pass
11b	2412	Ant1	2381.393	-58.24	-20	Pass
11b	2412	Ant1	2380.393	-58.26	-20	Pass
11b	2412	Ant1	2379.393	-58.3	-20	Pass
11b	2412	Ant1	2378.393	-58.31	-20	Pass
11b	2412	Ant1	2377.393	-58.32	-20	Pass
11b	2412	Ant1	2376.393	-42.17	-10	Pass
11b	2412	Ant1	2376.286	-46.39	-10	Pass
11b	2472	Ant1	2484	-42.55	-10	Pass
11b	2472	Ant1	2485	-46.97	-10	Pass
11b	2472	Ant1	2486	-47.61	-10	Pass
11b	2472	Ant1	2487	-50	-10	Pass
11b	2472	Ant1	2488	-49.28	-10	Pass
11b	2472	Ant1	2489	-50.09	-10	Pass
11b	2472	Ant1	2490	-51.16	-10	Pass
11b	2472	Ant1	2491	-52.4	-10	Pass
11b	2472	Ant1	2492	-53.12	-10	Pass
11b	2472	Ant1	2493	-54.24	-10	Pass
11b	2472	Ant1	2494	-55.6	-20	Pass
11b	2472	Ant1	2495	-55.11	-20	Pass
11b	2472	Ant1	2495.307	-57.14	-20	Pass
11b	2472	Ant1	2496.307	-43.76	-10	Pass
11b	2472	Ant1	2497.307	-43.8	-10	Pass

11b	2472	Ant1	2498.307	-45.3	-10	Pass
11b	2472	Ant1	2499.307	-47.94	-10	Pass
11b	2472	Ant1	2500.307	-46.81	-10	Pass
11b	2472	Ant1	2501.307	-46.22	-10	Pass
11b	2472	Ant1	2502.307	-48.64	-10	Pass
11b	2472	Ant1	2503.307	-48.4	-10	Pass
11b	2472	Ant1	2504.307	-46.58	-10	Pass
11b	2472	Ant1	2505.307	-49.47	-10	Pass
11b	2472	Ant1	2506.307	-50.18	-10	Pass
11b	2472	Ant1	2507.307	-53.78	-10	Pass

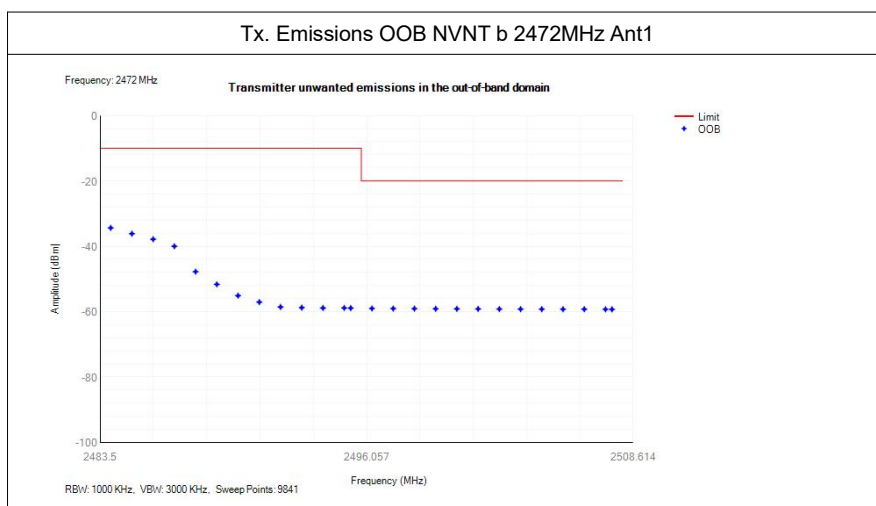
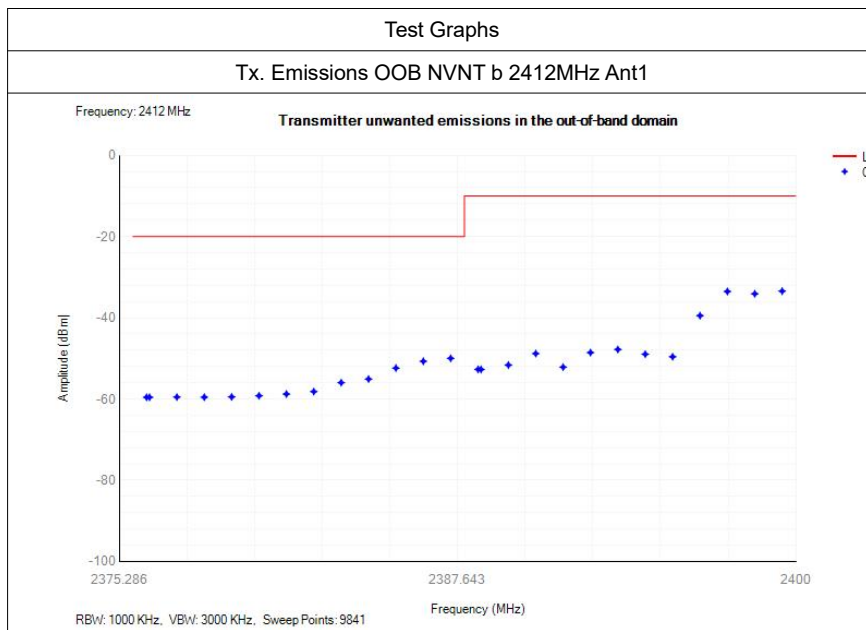

Note: All the modes had been tested, but only the worst data recorded in the report.

Appendix E. Transmitter unwanted emissions in the spurious domain

Measurement Data:

(Worst Case: Low channel, 11B)

Mode	Frequency (MHz)	Antenna	Range (MHz)	Spur Freq (MHz)	Peak (dBm)	Limit (dBm)	Verdict
11b	2412	Ant1	30 -47	43.35	-79.22	-36	Pass
11b	2412	Ant1	47 -74	65.00	-78.96	-54	Pass
11b	2412	Ant1	74 -87.5	82.95	-79.16	-36	Pass
11b	2412	Ant1	87.5 -118	99.05	-78.96	-54	Pass
11b	2412	Ant1	118 -174	162.75	-78.41	-36	Pass
11b	2412	Ant1	174 -230	187.90	-78.47	-54	Pass
11b	2412	Ant1	230 -470	292.65	-77.77	-36	Pass
11b	2412	Ant1	470 -694	600.00	-76.74	-54	Pass
11b	2412	Ant1	694 -1000	954.25	-75.56	-36	Pass
11b	2412	Ant1	1000 -2360	2119.50	-55.91	-30	Pass
11b	2412	Ant1	2523.5 -12750	10598.00	-46.30	-30	Pass
11b	2442	Ant1	30 -47	30.75	-79.24	-36	Pass
11b	2442	Ant1	47 -74	59.45	-79.18	-54	Pass
11b	2442	Ant1	74 -87.5	76.40	-79.64	-36	Pass
11b	2442	Ant1	87.5 -118	104.90	-79.30	-54	Pass
11b	2442	Ant1	118 -174	144.70	-78.47	-36	Pass
11b	2442	Ant1	174 -230	206.90	-77.98	-54	Pass
11b	2442	Ant1	230 -470	430.60	-77.19	-36	Pass
11b	2442	Ant1	470 -694	600.00	-76.34	-54	Pass
11b	2442	Ant1	694 -1000	761.40	-73.24	-36	Pass
11b	2442	Ant1	1000 -2360	2192.00	-56.01	-30	Pass
11b	2442	Ant1	2523.5 -12750	10647.00	-46.29	-30	Pass
11b	2472	Ant1	30 -47	32.55	-79.44	-36	Pass
11b	2472	Ant1	47 -74	61.70	-78.97	-54	Pass
11b	2472	Ant1	74 -87.5	76.35	-79.43	-36	Pass
11b	2472	Ant1	87.5 -118	104.55	-78.32	-54	Pass
11b	2472	Ant1	118 -174	144.45	-77.90	-36	Pass
11b	2472	Ant1	174 -230	217.15	-77.88	-54	Pass
11b	2472	Ant1	230 -470	260.85	-77.96	-36	Pass
11b	2472	Ant1	470 -694	600.05	-76.70	-54	Pass
11b	2472	Ant1	694 -1000	761.10	-75.32	-36	Pass
11b	2472	Ant1	1000 -2360	1745.50	-53.93	-30	Pass
11b	2472	Ant1	2523.5 -12750	11257.50	-46.49	-30	Pass

Test Graphs

Tx. Spurious NVNT b 2412MHz Ant1

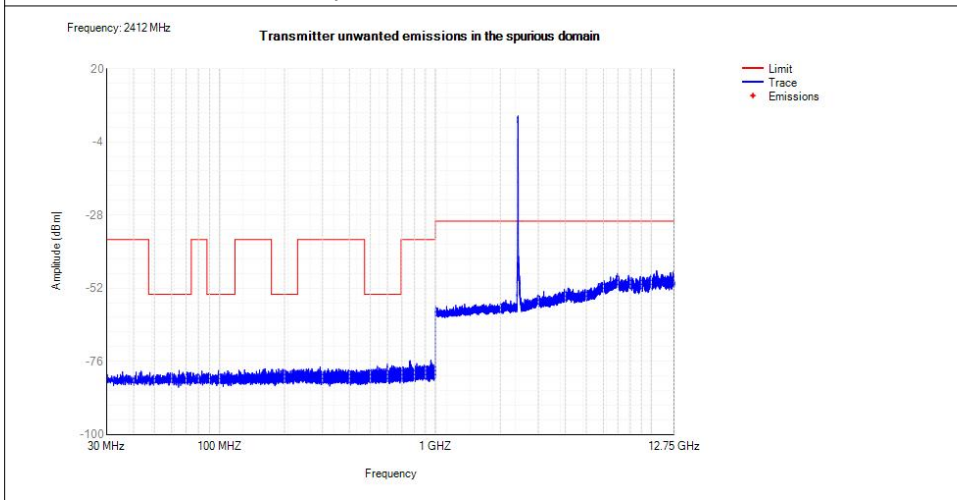

Tx. Spurious NVNT b 2442MHz Ant1

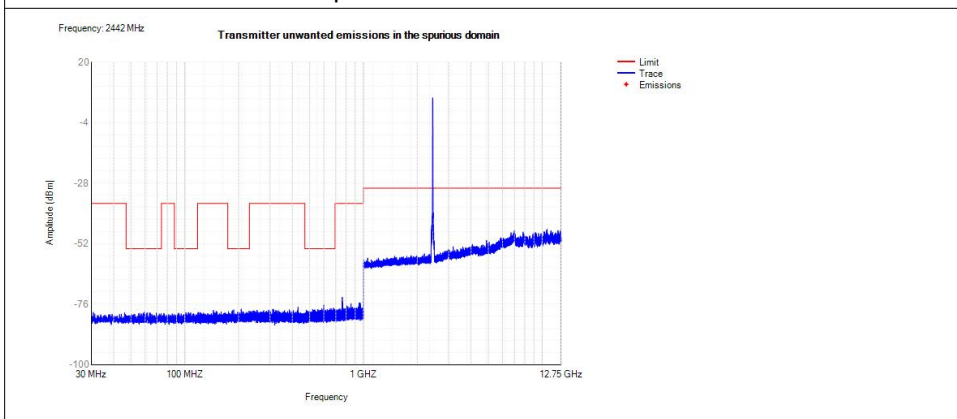

Tx. Spurious NVNT b 2472MHz Ant1

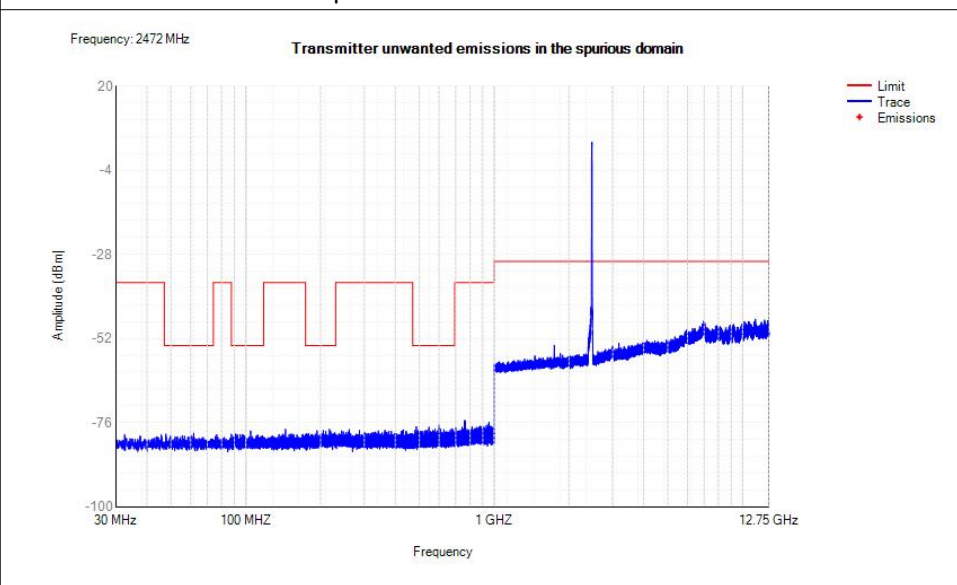

Appendix F. Receiver spurious emissions

Measurement Data:

(Worst Case: Low channel, 11B)

Mode	Frequency (MHz)	Antenna	Range (MHz)	Spur Freq (MHz)	Peak (dBm)	Limit (dBm)	Verdict
b	2412	Ant1	30 -1000	951.35	-75.37	-57	Pass
b	2412	Ant1	1000 -12750	12640.5	-58.04	-47	Pass
b	2472	Ant1	30 -1000	955.3	-75.05	-57	Pass
b	2472	Ant1	1000 -12750	12382.5	-57.86	-47	Pass

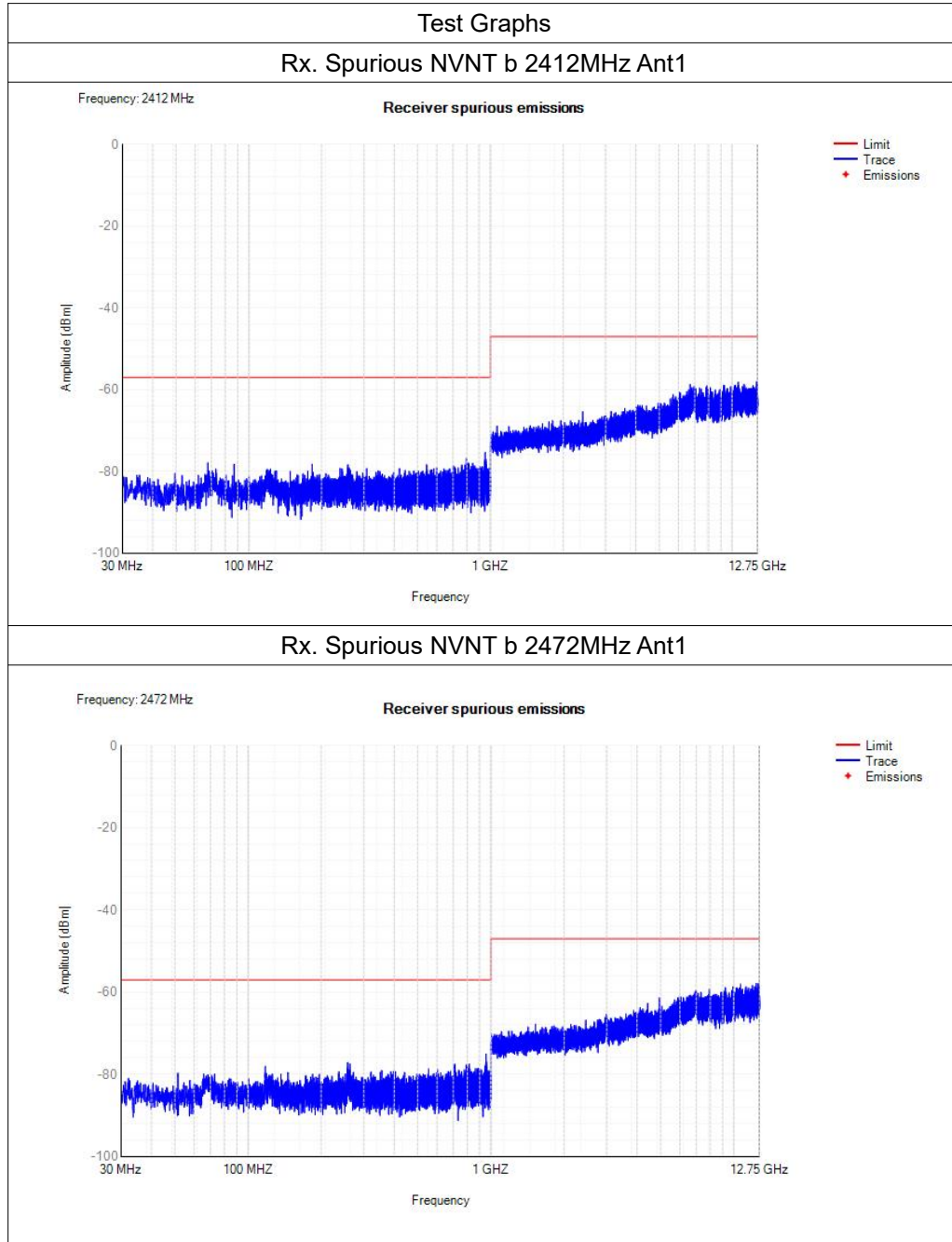

Appendix G. Receiver Blocking

Measurement Data:

(Worst Case: Low channel, 11B)

Test Data of Receiver Blocking						
Test channel	Blocking Signal Frequency (MHz)	Blocking Signal Power(dBm)	Wanted signal mean power from companion device(dBm)	Performance PER	Limit PER	Result
Low	2300	-32.80	-73.00	0.25%	10%	Pass
	2330		-73.00	0.70%		
	2360		-73.00	0.33%		
	2380		-67.00	0.51%		
High	2504		-67.00	0.19%		
	2524		-73.00	0.12%		
	2584		-73.00	0.22%		
	2674		-73.00	0.17%		

Note:

1. If the equipment can be configured to operate with different Nominal Channel Bandwidths (e.g. 20 MHz and 40 MHz) and different data rates, then the combination of the smallest channel bandwidth and the lowest data rate for this channel bandwidth which still allows the equipment to operate as intended shall be used.
2. The levels of the blocking signal and wanted signal have to be corrected for the (in-band) antenna assembly gain.

8 Test Setup photograph

RADIATED EMISSION TEST SETUP



RADIATED EMISSION ABOVE 1G TEST SETUP



-----END OF REPORT-----