



# **RADIO TEST REPORT**

## **ETSI EN 301 893 V2.1.1 (2017-05)**

**Product :** 4G Tablet

**Trade Mark :** Blackview

**Model Name :** Tab 12

**Family Model :** N/A

**Report No. :** STR211227002004E

### **Prepared for**

**DOKE COMMUNICATION (HK) LIMITED.**

**RM 1902 EASEY COMM BLDG 253-261 HENNESSY ROAD WANCHAI HK, CHINA**

### **Prepared by**

**Shenzhen NTEK Testing Technology Co., Ltd.**

**1/F, Building E, Fenda Science Park, Sanwei Community, Xixiang Street  
Bao'an District, Shenzhen 518126 P.R. China**

**Tel. 400-800-6106, 0755-2320 0050, 0755-2320 0090**

**Website: <http://www.ntek.org.cn>**

**TEST RESULT CERTIFICATION**

**Applicant's name** ..... : DOKE COMMUNICATION (HK) LIMITED.  
**Address** ..... : RM 1902 EASEY COMM BLDG 253-261 HENNESSY ROAD  
WANCHAI HK, CHINA

**Manufacturer's Name** ..... : Shenzhen DOKE Electronic Co.,Ltd.  
**Address** ..... : 801, Building3, 7th Industrial Zone, Yulv Community, Yutang  
Road, Guangming District, Shenzhen, China.

**Product description**

**Product name**..... : 4G Tablet  
**Trademark** ..... : Blackview  
**Model and/or type reference** : Tab 12  
**Family Model** ..... : N/A

**Standards** ..... : ETSI EN 301 893 V2.1.1 (2017-05)

This device described above has been tested by Shenzhen NTEK, and the test results show that the equipment under test (EUT) is in compliance with the 2014/53/EU RED Directive Art.3.2 requirements. And it is applicable only to the tested sample identified in the report.

This report shall not be reproduced except in full, without the written approval of Shenzhen NTEK, this document may be altered or revised by Shenzhen NTEK, personnel only, and shall be noted in the revision of the document.

**Date of Test**..... :

**Date (s) of performance of tests**..... : Dec 27, 2021 ~ Feb 16, 2022

**Date of Issue**..... : Feb 16, 2022

**Test Result**..... : **Pass**

Testing Engineer :



(Mary Hu)

Authorized Signatory :



(Alex Li)





**Table of Contents**

**Page**

1 . SUMMARY OF TEST RESULTS	7
1.1 TEST FACILITY	8
1.2 MEASUREMENT UNCERTAINTY	8
2 . GENERAL INFORMATION	9
2.1 GENERAL DESCRIPTION OF EUT	9
2.2 TEST CONDITIONS AND CHANNEL	12
2.3 DESCRIPTION OF TEST CONDITIONS	13
2.4 DESCRIPTION OF SUPPORT UNITS	14
2.5 EQUIPMENTS LIST FOR ALL TEST ITEMS	15
3 . CENTRE FREQUENCIES	16
3.1 APPLIED PROCEDURES / LIMIT	16
3.1.1 LIMIT	16
3.1.2 TEST PROCEDURES	16
3.1.3 TEST MOTHOD	16
3.1.4 TEST SETUP LAYOUT	17
3.1.5 TEST RESULTS	18
4 . NOMINAL CHANNEL BANDWIDTH AND OCCUPIED CHANNEL BANDWIDTH20	
4.1 APPLIED PROCEDURES / LIMIT	20
4.1.1 LIMIT	20
4.1.2 TEST PROCEDURES	20
4.1.3 TEST METHOD	21
4.1.4 TEST SETUP LAYOUT	21
4.1.5 TEST RESULTS	22
5 . RF OUTPUT POWER, TRANSMIT POWER CONTROL (TPC) AND POWER DENSITY	23
5.1 APPLIED PROCEDURES / LIMIT	23
5.2 TEST PROCEDURES	23
5.3 TEST SETUP LAYOUT	23
5.4 TEST RESULTS	24
6 . TRANSMITTER UNWANTED EMISSIONS OUTSIDE THE 5 GHZ RLAN BANDS25	
6.1 APPLIED PROCEDURES / LIMIT	25
6.1.1 CONFORMANCE	25
6.1.3 TEST RESULTS (30MHz ~ 1000MHz)	27
6.1.4 TEST RESULTS (1.0GHz ~26GHz)	28
7 . TRANSMITTER UNWANTED EMISSIONS WITHIN THE 5 GHZ RLAN BANDS29	

**Table of Contents**

**Page**

7.1 APPLIED PROCEDURES / LIMIT	29
7.1.1 TEST PROCEDURES	29
7.1.2 TEST SETUP LAYOUT	29
7.1.3 TEST RESULTS	30
8 . RECEIVER SPURIOUS EMISSIONS	31
8.1 APPLIED PROCEDURES / LIMIT	31
8.1.1 TEST PROCEDURES	31
8.1.2 TEST SETUP LAYOUT	31
8.1.3 TEST RESULTS	32
9 . ADAPTIVITY (CHANNEL ACCESS MECHANISM)	33
9.1 APPLICABILITY OF ADAPTIVE REQUIREMENTS AND LILIT	33
9.2 TEST SETUP CONFIGURATION	34
9.3 LIST OF MEASUREMENTS	34
9.4 TEST RESULTS	34
10 . RECEIVER BLOCKING	35
10.1 LIMITS OF RECEIVER BLOCKING	35
10.2 TEST PROCEDURE	35
10.3 DEVIATION FROM TEST STANDARD	35
10.4 TEST SETUP	35
10.5 TEST RESULTS	36
11 . USER ACCESS RESTRICTIONS	37
11.1 APPLIED PROCEDURES / LIMIT	37
11.2 TEST RESULTS	37
12 . GEO-LOCATION CAPABILITY	37
12.1 APPLIED PROCEDURES / LIMIT	37
12.2 TEST RESULTS	37
13 TEST RESULTS	38
13.1 OCCUPIED CHANNEL BANDWIDTH	38
13.2 RF OUTPUT POWER	41
13.3 POWER SPECTRAL DENSITY	44
13.4 TRANSMITTER UNWANTED EMISSIONS IN THE SPURIOUS DOMAIN	47
13.5 TRANSMITTER UNWANTED EMISSIONS WITHIN THE 5 GHZ RLAN BANDS	50
13.6 RECEIVER SPURIOUS EMISSIONS	55
13.7 ADAPTIVITY	58
13.8 ADAPTIVITY COT CHANNEL OCCUPANCY TIME	67
13.9 ADAPTIVITY COT IDLE PERIOD PROBABILITY	70

**Table of Contents****Page**

14. EUT TEST PHOTO

72

SPURIOUS EMISSIONS MEASUREMENT PHOTOS

72

APPENDIX-PHOTOGRAPHS OF EUT CONSTRUCTIONAL DETAILS



### 1. SUMMARY OF TEST RESULTS

Test procedures according to the technical standards:

ETSI EN 301 893 V2.1.1			
Clause	Test Item	Applicable	NOTE
4.2.1	Centre Frequencies	Compliance	
4.2.2	Nominal Channel Bandwidth and Occupied Channel Bandwidth	Compliance	
4.2.3	RF output power	Compliance	
4.2.3	Transmit Power Control (TPC)	Not Applicable	
4.2.3	Power Density	Compliance	
4.2.4.1	Transmitter unwanted emissions outside the 5 GHz RLAN bands	Compliance	
4.2.4.2	Transmitter unwanted emissions within the 5 GHz RLAN bands	Compliance	
4.2.5	Receiver spurious emissions	Compliance	
4.2.6	Dynamic Frequency Selection (DFS)	Not Applicable	
4.2.7	Adaptivity (Channel Access Mechanism)	Compliance	
4.2.8	Receiver Blocking	Compliance	
4.2.9	User Access Restrictions	Compliance*	
4.2.10	Geo-location capability	Compliance*	

Note:

1. Compliance\*: Please refer to the product information declared by the manufacturer.
2. The antenna gain provided by customer is used to calculate the EIRP result. NTEK is not responsible for the accuracy of antenna gain parameter.

1.1 TEST FACILITY

Shenzhen NTEK Testing Technology Co., Ltd.

Add. : 1/F, Building E, Fenda Science Park, Sanwei Community, Xixiang Street, Bao'an District, Shenzhen 518126 P.R. China

FCC Registered No.: 238937 IC Registered No.:9270A-1

CNAS Registration No.:L5516

1.2 MEASUREMENT UNCERTAINTY

The reported uncertainty of measurement  $y \pm U$ , where expanded uncertainty  $U$  is based on a standard uncertainty multiplied by a coverage factor of  $k=2$ , providing a level of confidence of approximately 95 %.

No.	Item	Uncertainty
1	Conducted Emission Test	$\pm 1.38\text{dB}$
2	RF power,conducted	$\pm 0.16\text{dB}$
3	Spurious emissions,conducted	$\pm 0.21\text{dB}$
4	All emissions,radiated(<1G)	$\pm 4.68\text{dB}$
5	All emissions,radiated(>1G)	$\pm 4.89\text{dB}$
6	Temperature	$\pm 0.5^\circ\text{C}$
7	Humidity	$\pm 2\%$



## 2. GENERAL INFORMATION

### 2.1 GENERAL DESCRIPTION OF EUT

Equipment	4G Tablet	
Trade Mark	Blackview	
Model Name.	Tab 12	
Family Model	N/A	
Model Difference	N/A	
Product Description	The EUT is a 4G Tablet	
	Operation Frequency:	802.11a/ n(20/40)/ac(20/40/80): <input checked="" type="checkbox"/> 5180MHz~5240MHz(20MHz) <input checked="" type="checkbox"/> 5190MHz~5230MHz(40MHz) <input checked="" type="checkbox"/> 5210MHz(80MHz)
	Modulation Type:	802.11a: OFDM (BPSK / QPSK / 16QAM) 802.11n: OFDM (QPSK/BPSK/16QAM/64QAM) 802.11ac:OFDM (QPSK/BPSK/16QAM/64QAM/256QAM)
	Bit Rate of Transmitter	802.11a: 6/9/12/18/24/36/48/54Mbps; 802.11n (20MHz): up to MCS0-7 802.11n (40MHz): up to MCS0-7 802.11ac (20MHz): up to MCS0-8 802.11ac (40MHz): up to MCS0-9 802.11ac (80MHz): up to MCS0-9
	Number Of Channel	Please see Note 2.
	Antenna Designation:	PIFA Antenna
	Antenna Gain(Peak)	1.41dBi
	Based on the application, features, or specification exhibited in User's Manual, the EUT is considered as an ITE/Computing Device. More details of EUT technical specification, please refer to the User's Manual.	
	Channel List	Refer to below
	Power supply	Adapter 1: Model: HJ-0502000C2-EU Input: 100-240V~50/60Hz 0.3A Output: 5V---2.0A 10.0W Adapter 2: Model: HJ-0502000K9-EU Input: 100-240V~50/60Hz 0.3A Output: 5V---2.0A 10.0W
Battery	DC 3.8V, 6580mAh	
Rating	DC 3.8V from battery or DC 5V from Adapter	
Hardware Version	T30-9863A-V1.0-220120-G	
Software Version	Tab 12_EEA_T30_V1.0	

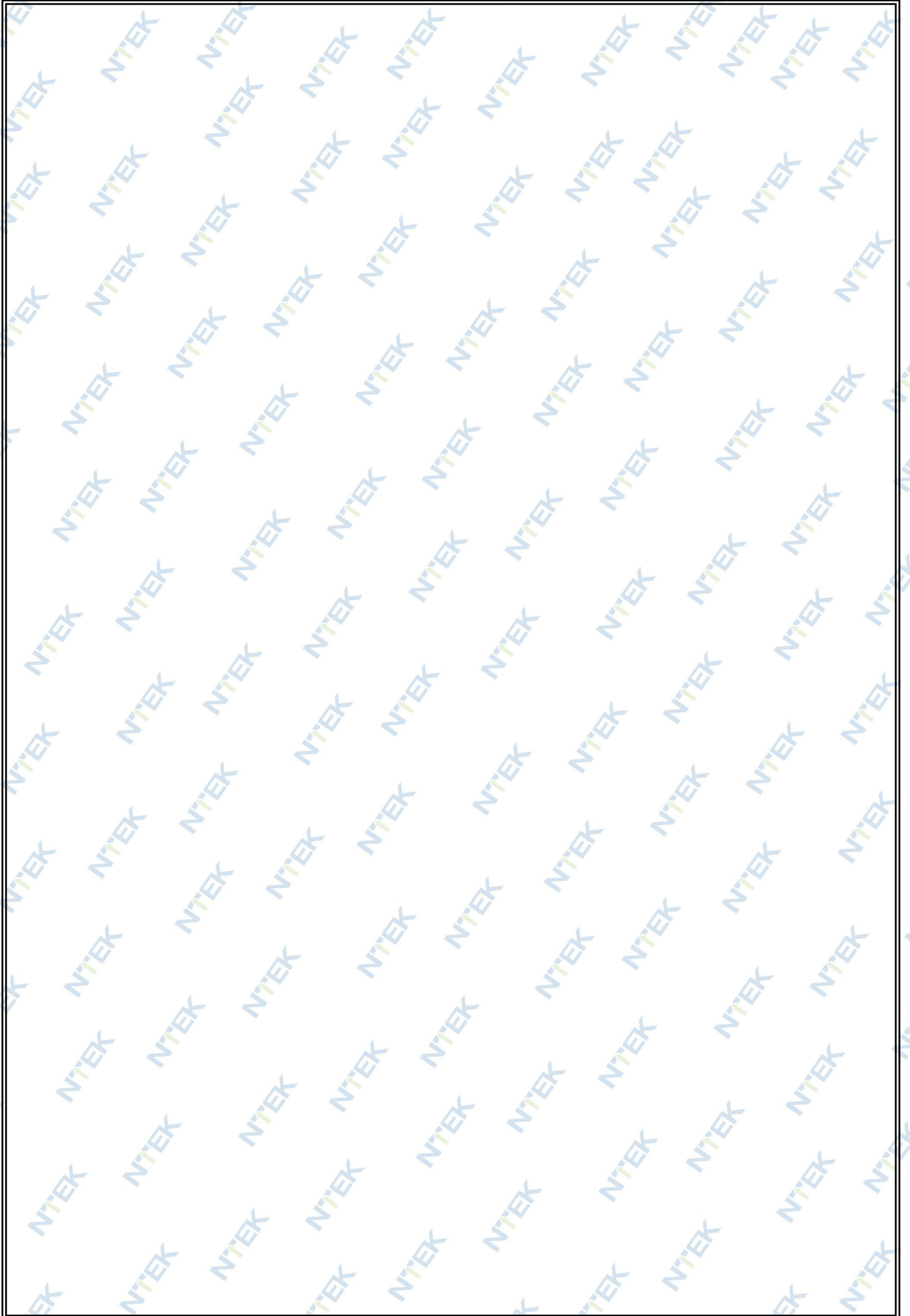

Note:																																							
1.	For a more detailed features description, please refer to the manufacturer's specifications or the User's Manual.																																						
2.	<input checked="" type="checkbox"/> <table border="1" style="width: 100%; text-align: center;"> <tr> <td colspan="8">802.11a/n/ac( 20MHz) Carrier Frequency Channel</td> </tr> <tr> <td>Channel</td> <td>Frequen cy (MHz)</td> <td>Channel</td> <td>Frequen cy (MHz)</td> <td>Channel</td> <td>Frequen cy (MHz)</td> <td>Channel</td> <td>Frequen cy (MHz)</td> </tr> <tr> <td>36</td> <td>5180</td> <td>44</td> <td>5220</td> <td>-</td> <td>-</td> <td>-</td> <td>-</td> </tr> <tr> <td>40</td> <td>5200</td> <td>48</td> <td>5240</td> <td>-</td> <td>-</td> <td>-</td> <td>-</td> </tr> </table>							802.11a/n/ac( 20MHz) Carrier Frequency Channel								Channel	Frequen cy (MHz)	Channel	Frequen cy (MHz)	Channel	Frequen cy (MHz)	Channel	Frequen cy (MHz)	36	5180	44	5220	-	-	-	-	40	5200	48	5240	-	-	-	-
802.11a/n/ac( 20MHz) Carrier Frequency Channel																																							
Channel	Frequen cy (MHz)	Channel	Frequen cy (MHz)	Channel	Frequen cy (MHz)	Channel	Frequen cy (MHz)																																
36	5180	44	5220	-	-	-	-																																
40	5200	48	5240	-	-	-	-																																
	<input checked="" type="checkbox"/> <table border="1" style="width: 100%; text-align: center;"> <tr> <td colspan="8">802.11n/ac(40MHz) Carrier Frequency Channel</td> </tr> <tr> <td>Channel</td> <td>Frequen cy (MHz)</td> <td>Channel</td> <td>Frequen cy (MHz)</td> <td>Channel</td> <td>Frequen cy (MHz)</td> <td>Channel</td> <td>Frequen cy (MHz)</td> </tr> <tr> <td>38</td> <td>5190</td> <td>-</td> <td>-</td> <td>-</td> <td>-</td> <td>-</td> <td>-</td> </tr> <tr> <td>46</td> <td>5230</td> <td>-</td> <td>-</td> <td>-</td> <td>-</td> <td>-</td> <td>-</td> </tr> </table>							802.11n/ac(40MHz) Carrier Frequency Channel								Channel	Frequen cy (MHz)	Channel	Frequen cy (MHz)	Channel	Frequen cy (MHz)	Channel	Frequen cy (MHz)	38	5190	-	-	-	-	-	-	46	5230	-	-	-	-	-	-
802.11n/ac(40MHz) Carrier Frequency Channel																																							
Channel	Frequen cy (MHz)	Channel	Frequen cy (MHz)	Channel	Frequen cy (MHz)	Channel	Frequen cy (MHz)																																
38	5190	-	-	-	-	-	-																																
46	5230	-	-	-	-	-	-																																
	<input checked="" type="checkbox"/> <table border="1" style="width: 100%; text-align: center;"> <tr> <td colspan="8">802.11ac (80MHz) Carrier Frequency Channel</td> </tr> <tr> <td colspan="4">Channel</td> <td colspan="4">Frequency (MHz)</td> </tr> <tr> <td colspan="4">42</td> <td colspan="4">5210</td> </tr> </table>							802.11ac (80MHz) Carrier Frequency Channel								Channel				Frequency (MHz)				42				5210											
802.11ac (80MHz) Carrier Frequency Channel																																							
Channel				Frequency (MHz)																																			
42				5210																																			



## 2.2 TEST CONDITIONS AND CHANNEL

### Test conditions:

	Normal Test Conditions	Extreme Test Conditions
Temperature	15°C - 35°C	40°C ~ -10°C Note: (1)
Relative Humidity	20% - 75%	N/A
Supply Voltage	DC 3.8V	/

Note:

(1) The HT 40°C and LT -10°C was declared by manufacturer, The EUT couldn't be operate normally with higher or lower temperature.

### Test channels:

Please refer to the table below:

Test	Clause	Test channels		
		Lower sub-band (5 150 MHz to 5 350 MHz)		Higher sub-band 5 470 MHz to 5 725 MHz
		5 150 MHz to 5 250 MHz	5 250 MHz to 5 350 MHz	
Centre frequencies	5.4.2	C7 (see note 1)		C8 (see note 1)
Occupied Channel Bandwidth	5.4.3	C7		C8
Power/ Power Density	5.4.4	C1	C2	C3, C4
Transmitter unwanted emissions outside the 5 GHz RLAN bands	5.4.5	C7 (see note 1)		C8 (see note 1)
Transmitter unwanted emissions within the 5 GHz RLAN bands	5.4.6	C1	C2	C3, C4
Receiver spurious emissions	5.4.7	C7 (see note 1)		C8 (see note 1)
Transmit Power Control (TPC)	5.4.4	n.a. (see note 2)	C2 (see note 1)	C3, C4 (see note 1)
Dynamic Frequency Selection (DFS)	5.4.8	n.a. (see note 2)	C5	C6 (see note 3)
Adaptivity	5.4.9	C9		
Receiver Blocking	5.4.10	C7		C8

**C1, C3:** The lowest declared channel for every declared Nominal Channel Bandwidth within this band. For the Power Density testing, it is sufficient to only perform this test using the lowest Nominal Channel Bandwidth.

**C2, C4:** The highest declared channel for every declared Nominal Channel Bandwidth within this band. For the Power Density testing, it is sufficient to only perform this test using the lowest Nominal Channel Bandwidth.

**C5, C6:** One channel out of the declared channels for this frequency range. If more than one Nominal Channel Bandwidth has been declared for this sub-band, testing shall be performed using the lowest and highest Nominal Channel Bandwidth.

**C7, C8:** One channel out of the declared channels for this sub-band. For Occupied Channel Bandwidth, testing shall be repeated for every declared Nominal Channel Bandwidth within this sub-band.

**C9:** One channel (in case of single-channel testing) or a group of channels (in case of multi-channel testing) out of the declared channels.

**NOTE 1:** In case of more than one channel plan has been declared, testing of these specific requirements need only be performed using one of the declared channel plans.

**NOTE 2:** Testing is not required for Nominal Channel Bandwidths that fall completely within the frequency range 5 150 MHz to 5 250 MHz.

**NOTE 3:** Where the declared channel plan includes channels whose Nominal Channel Bandwidth falls completely or partly within the 5 600 MHz to 5 650 MHz band, the tests for the Channel Availability Check (and where implemented, for the Off-Channel CAC) shall be performed on one of these channels in addition to a channel within the band 5 470 MHz to 5 600 MHz or within the band 5 650 MHz to 5 725 MHz.

**NOTE 4:** For Receiver Blocking, just test the channel of smallest channel bandwidth and the lowest data rate.

2.3 DESCRIPTION OF TEST CONDITIONS

E-1  
EUT

**2.4 DESCRIPTION OF SUPPORT UNITS**

The EUT has been tested as an independent unit together with other necessary accessories or support units. The following support units or accessories were used to form a representative test configuration during the tests.

Item	Equipment	Model/Type No.	Series No.	Note
E-1	4G Tablet	Tab 12	N/A	EUT

Item	Type	Shielded Type	Ferrite Core	Length	Note

Note:

- (1) The support equipment was authorized by Declaration of Confirmation.
- (2) For detachable type I/O cable should be specified the length in cm in 「Length」 column.



2.5 EQUIPMENTS LIST FOR ALL TEST ITEMS

EQUIPMENT TYPE	Manufacturer	Type No.	Serial No.	Last calibration	Calibrated until	Calibration period
EMI Test Receiver	R&S	ESPI7	101318	2021.04.27	2022.04.26	1 year
Bilog Antenna	TESEQ	CBL6111D	31216	2021.03.29	2022.03.28	1 year
Turn Table	EM	SC100_1	60531	N/A	N/A	N/A
Antnna Mast	EM	SC100	N/A	N/A	N/A	N/A
Horn Antenna	EM	EM-AH-10180	2011071402	2021.03.29	2022.03.28	1 year
Horn Ant	Schwarzbeck	BBHA 9170	9170-181	2021.04.27	2022.04.26	1 year
Test Cable (30MHz-1GHz)	N/A	R-01	N/A	2019.08.06	2022.08.05	3 year
Test Cable (1-18GHz)	N/A	R-02	N/A	2019.08.06	2022.08.05	3 year
50Ω Coaxial Switch	Anritsu	MP59B	6200983705	2020.05.11	2023.05.10	3 year
Pre-Amplifier	EMC	EMC051835SE	980246	2021.07.01	2022.06.30	1 year
Spectrum Analyzer	Agilent	E4407B	MY45108040	2021.04.27	2022.04.26	1 year
Filter	TRILTHIC	2400MHz	29	2020.04.07	2023.04.06	3 year
Attenuator	Weinschel	33-10-33	AR4010	2020.04.07	2023.04.06	3 year
Attenuator	Weinschel	24-20-34	BP4485	2020.04.07	2023.04.06	3 year
MXA Signal Analyzer	Agilent	N9020A	MY49100060	2021.07.01	2022.06.30	1 year
ESG VETCTOR SIGNAL GENERATOR	Agilent	E4438C	MY45093347	2021.04.27	2022.04.26	1 year
PSG Analog Signal Generator	Agilent	E8257D	MY51110112	2021.07.01	2022.06.30	1 year
Power Splitter	Mini-Circuits/ USA	ZN2PD-63-S+	SF025101428	2020.04.07	2023.04.06	3 year
Coupler	Mini-Circuits	ZADC-10-63-S +	SF794101410	2020.04.07	2023.04.06	3 year
Directional Coupler	MCLI/USA	CB11-20	0D2L51502	2020.07.17	2023.07.16	3 year
Attenuator	Agilent	8495B	MY42147029	2020.04.13	2023.04.12	3 year
Power Meter	DARE	RPR3006W	15100041SNO 84	2021.07.01	2022.06.30	1 year
MXG Vector Signal Generator	Agilent	N5182A	MY47070317	2021.04.27	2022.04.26	1 year
Wideband Radio Communication Tester Specifications	R&S	CMW500	148500	2021.04.27	2022.04.26	1 year
temporary antenna connector (Note)	NTS	R001	N/A	N/A	N/A	N/A

### 3. CENTRE FREQUENCIES

#### 3.1 APPLIED PROCEDURES / LIMIT

##### 3.1.1 LIMIT

The actual centre frequency for any given channel declared by the manufacturer shall be maintained within the range  $f_c \pm 20$  ppm

##### 3.1.2 TEST PROCEDURES

###### **Test conditions**

These measurements shall be performed under both normal and extreme test conditions (see clause 5.1.1).

The channels on which the conformance requirements in clause 4.2 shall be verified are defined in clause 5.1.3.

The UUT shall be configured to operate at a normal RF Output Power level. In addition, the UUT shall be configured to operate on a single channel.

For a UUT with antenna connector(s) and using dedicated external antenna(s), or for a UUT with integral antenna(s) but with a temporary antenna connector(s) provided, conducted measurements shall be used.

In case of conducted measurements on smart antenna systems (devices with multiple transmit chains) the measurements shall be performed on only one of the active transmit chains.

For a UUT with integral antenna(s) and without a temporary antenna connector(s), radiated measurements shall be used.

##### 3.1.3 TEST METHOD

###### **Conducted measurement:**

###### 1. Equipment operating without modulation

This test method requires that the UUT can be operated in an unmodulated test mode.

The UUT shall be connected to a frequency counter and operated in an unmodulated mode. The result shall be recorded.

###### 2. Equipment operating with modulation

This method is an alternative to the above method in case the UUT cannot be operated in an un-modulated mode.

The UUT shall be connected to spectrum analyser.

The settings of the spectrum analyser shall be adjusted to optimize the instruments frequency accuracy.

Max Hold shall be selected and the centre frequency adjusted to that of the UUT.

The peak value of the power envelope shall be measured and noted. The span shall be reduced and the marker moved in a positive frequency increment until the upper, (relative to the centre frequency), -10 dBc point is reached. This value shall be noted as f1.

The marker shall then be moved in a negative frequency increment until the lower, (relative to the centre frequency), -10 dBc point is reached. This value shall be noted as f2.

The centre frequency is calculated as  $(f1 + f2) / 2$ .

###### **Radiated measurement:**

The test set up as described in annex B (ETSI EN 301 893 V2.1.1) shall be used with a spectrum analyser of sufficient accuracy attached to the test antenna.

The test procedure is as described under conducted measurement.



### 3.1.4 TEST SETUP LAYOUT

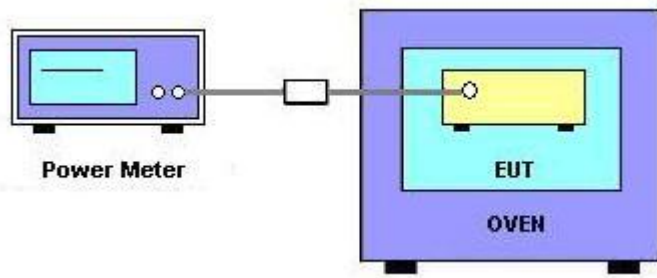



### 3.1.5 TEST RESULTS

EUT :	4G Tablet	Model Name :	Tab 12
Temperature :	20 °C	Relative Humidity	54%
Pressure :	1012 hPa	Test Voltage :	DC 3.8V
Test Mode :	Tx Mode-802.11(a/n20/n40/ac20/ac40/ac80)		

#### 802.11a

TEST CONDITIONS				Reference Frequency: 5180MHz			
				fL	fH	(fL+fH)/2	Frequency Deviation (ppm)
T nom (°C)	20	V nom (V)	3.8	5171.741	5188.215	5179.978	-4.25
T min (°C)	-20	V nom (V)		5171.744	5188.217	5179.981	-3.76
T max (°C)	40	V nom (V)		5171.740	5188.216	5179.978	-4.25
Limits				± 20 ppm			
<b>Result</b>				<b>Complies</b>			

#### 802.11n20

TEST CONDITIONS				Reference Frequency: 5180MHz			
				fL	fH	(fL+fH)/2	Frequency Deviation (ppm)
T nom (°C)	20	V nom (V)	3.8	5171.741	5188.183	5179.962	-7.34
T min (°C)	-20	V nom (V)		5171.743	5188.184	5179.964	-7.05
T max (°C)	40	V nom (V)		5171.739	5188.186	5179.963	-7.24
Limits				± 20 ppm			
<b>Result</b>				<b>Complies</b>			

#### 802.11n40

TEST CONDITIONS				Reference Frequency: 5190MHz			
				fL	fH	(fL+fH)/2	Frequency Deviation (ppm)
T nom (°C)	20	V nom (V)	3.8	5171.882	5207.978	5189.930	-13.49
T min (°C)	-20	V nom (V)		5171.885	5207.98	5189.933	-13.01
T max (°C)	40	V nom (V)		5171.876	5207.980	5189.928	-13.87
Limits				± 20 ppm			
<b>Result</b>				<b>Complies</b>			

802.11ac20

TEST CONDITIONS				Reference Frequency: 5180MHz			
				fL	fH	(fL+fH)/2	Frequency Deviation (ppm)
T nom (°C)	20	V nom (V)	3.8	5171.741	5188.197	5179.969	-5.98
T min (°C)	-20	V nom (V)		5171.743	5188.198	5179.971	-5.69
T max (°C)	40	V nom (V)		5171.739	5188.200	5179.970	-5.89
Limits				± 20 ppm			
<b>Result</b>				<b>Complies</b>			

802.11ac40

TEST CONDITIONS				Reference Frequency: 5190MHz			
				fL	fH	(fL+fH)/2	Frequency Deviation (ppm)
T nom (°C)	20	V nom (V)	3.8	5172.082	5207.998	5190.040	7.71
T min (°C)	-20	V nom (V)		5172.084	5207.999	5190.042	8.00
T max (°C)	40	V nom (V)		5172.080	5208.000	5190.040	7.71
Limits				± 20 ppm			
<b>Result</b>				<b>Complies</b>			

802.11ac80

TEST CONDITIONS				Reference Frequency: 5210MHz			
				fL	fH	(fL+fH)/2	Frequency Deviation (ppm)
T nom (°C)	20	V nom (V)	3.8	5172.036	5247.876	5209.956	-8.45
T min (°C)	-20	V nom (V)		5172.042	5247.877	5209.960	-7.77
T max (°C)	40	V nom (V)		5172.035	5247.877	5209.956	-8.45
Limits				± 20 ppm			
<b>Result</b>				<b>Complies</b>			



## 4. NOMINAL CHANNEL BANDWIDTH AND OCCUPIED CHANNEL BANDWIDTH

### 4.1 APPLIED PROCEDURES / LIMIT

#### 4.1.1 LIMIT

The Nominal Channel Bandwidth shall be at least 5 MHz at all times.

The Occupied Channel Bandwidth shall be between 80 % and 100 % of the declared Nominal Channel Bandwidth. In case of smart antenna systems (devices with multiple transmit chains) each of the transmit chains shall meet this requirement.

NOTE: During an established communication, a device is allowed to operate temporarily in a mode where its Occupied Channel Bandwidth may be reduced to as low as 40 % of its Nominal Channel Bandwidth with a minimum of 4 MHz.

#### 4.1.2 TEST PROCEDURES

##### **Test conditions**

The conformance requirements shall be verified only under normal operating conditions, and on those channels and channel bandwidths defined in clause 5.1.3(ETSI EN 301 893 V2.1.1).

The measurements shall be performed using normal operation of the equipment with the test signal applied.

The UUT shall be configured to operate at a typical RF power output level.

When equipment has simultaneous transmissions in adjacent channels, these transmissions may be considered as one signal with an actual Nominal Channel Bandwidth of 'n' times the individual Nominal Channel Bandwidth where 'n' is the number of adjacent channels. When equipment has simultaneous transmissions in non-adjacent channels, each power envelope shall be considered separately.

For a UUT with antenna connector(s) and using dedicated external antenna(s), or for a UUT with integral antenna(s) but with a temporary antenna connector(s) provided, conducted measurements shall be used.

In case of conducted measurements on smart antenna systems (devices with multiple transmit chains) measurements need only to be performed on one of the active transmit chains (antenna outputs).

For a UUT with integral antenna(s) and without a temporary antenna connector(s), radiated measurements shall be used.



#### 4.1.3 TEST METHOD

##### Conducted measurement

The measurement procedure shall be as follows:

##### Step 1:

Connect the UUT to the spectrum analyser and use the following settings:

- Centre Frequency: The centre frequency of the channel under test
- Resolution BW: 100 kHz
- Video BW: 300 kHz
- Frequency Span: 2 x Nominal Bandwidth (e.g. 40 MHz for a 20 MHz channel)
- > 1 s; for larger Nominal Bandwidths, the sweep time may be increased until a value where the sweep time has no impact on the RMS value of the signal
- Detector Mode: RMS
- Trace Mode: Max Hold

##### Step 2:

Wait for the trace to stabilize.

##### Step 3:

- Make sure that the power envelope is sufficiently above the noise floor of the analyser to avoid the noise signals left and right from the power envelope being taken into account by this measurement.
- Use the 99 % bandwidth function of the spectrum analyser to measure the Occupied Channel Bandwidth of the UUT. This value shall be recorded.

The measurement described in step 1 to step 3 above shall be repeated in case of simultaneous transmissions in non-adjacent channels.

##### Radiated measurement

The test set up as described in annex B (ETSI EN 301 893 V2.1.1) and the applicable measurement procedures described in annex C (ETSI EN 301 893 V2.1.1) shall be used. The test procedure is as described under conducted measurement.

#### 4.1.4 TEST SETUP LAYOUT

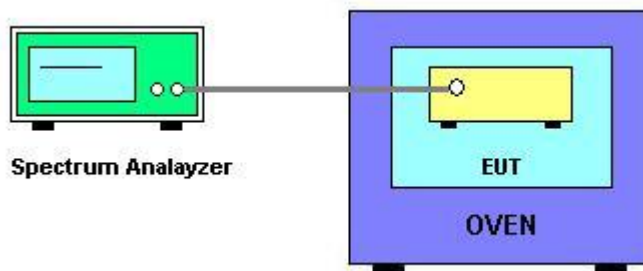

**4.1.5 TEST RESULTS**

EUT :	4G Tablet	Model Name :	Tab 12
Temperature :	24°C	Relative Humidity:	54 %
Pressure :	1012 hPa	Test Voltage :	DC 3.8V
Test Mode :	TX Mode-802.11(a/n20/n40/ac20/ac40/ac80)		

Test data reference attachment

**5. RF OUTPUT POWER, TRANSMIT POWER CONTROL (TPC) AND POWER DENSITY**

**5.1 APPLIED PROCEDURES / LIMIT**

TPC is not required for channels whose nominal bandwidth falls completely within the band 5 150 MHz to 5 250 MHz.

For devices with TPC, the RF output power and the power density when configured to operate at the highest stated power level of the TPC range shall not exceed the levels given in table 2.

Devices are allowed to operate without TPC. See table 2 for the applicable limits in this case.

**Table 2: Mean e.i.r.p. limits for RF output power and power density at the highest power level**

Frequency range [MHz]	Mean e.i.r.p. limit [dBm]		Mean e.i.r.p. density limit [dBm/MHz]	
	with TPC	without TPC	with TPC	without TPC
5 150 to 5 350	23	20/23 (see note 1)	10	7/10 (see note 2)
5 470 to 5 725	30 (see note 3)	27 (see note 3)	17 (see note 3)	14 (see note 3)

NOTE 1: The applicable limit is 20 dBm, except for transmissions whose nominal bandwidth falls completely within the band 5 150 MHz to 5 250 MHz, in which case the applicable limit is 23 dBm.

NOTE 2: The applicable limit is 7 dBm/MHz, except for transmissions whose nominal bandwidth falls completely within the band 5 150 MHz to 5 250 MHz, in which case the applicable limit is 10 dBm/MHz.

NOTE 3: Slave devices without a Radar Interference Detection function shall comply with the limits for the band 5 250 MHz to 5 350 MHz.

For devices using TPC, the RF output power during a transmission burst when configured to operate at the lowest stated power level of the TPC range shall not exceed the levels given in table 3. For devices without TPC, the limits in table 3 do not apply.

**Table 3: Mean e.i.r.p. limits for RF output power at the lowest power level of the TPC range**

Frequency range	Mean e.i.r.p. [dBm]
5 250 MHz to 5 350 MHz	17
5 470 MHz to 5 725 MHz	24 (see note)

NOTE: Slave devices without a Radar Interference Detection function shall comply with the limits for the band 5 250 MHz to 5 350 MHz.

**5.2 TEST PROCEDURES**

According to ETSI EN 301 893 V2.1.1 (2017-05) §5.4.4

**5.3 TEST SETUP LAYOUT**

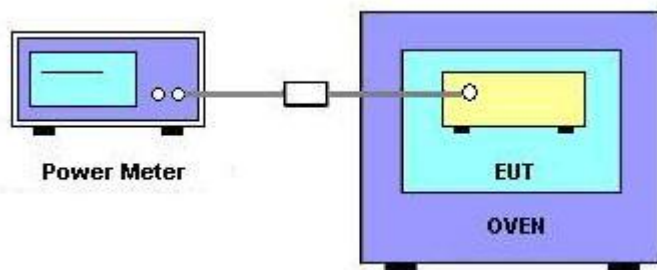



### 5.4 TEST RESULTS

#### RF Output Power

EUT :	4G Tablet	Model Name :	Tab 12
Temperature :	24°C	Relative Humidity:	54 %
Pressure :	1012 hPa	Test Voltage :	DC 3.8V
Test Mode :	Tx Mode-802.11(a/n20/n40/ac20/ac40/ac80)		

Test data reference attachment

#### Power density

EUT :	4G Tablet	Model Name :	Tab 12
Temperature :	24°C	Relative Humidity:	54 %
Pressure :	1012 hPa	Test Voltage :	DC 3.8V
Test Mode :	Tx Mode-802.11(a/n20/n40/ac20/ac40/ac80)		

Test data reference attachment

**6. TRANSMITTER UNWANTED EMISSIONS OUTSIDE THE 5 GHZ RLAN BANDS**

**6.1 APPLIED PROCEDURES / LIMIT**

The level of transmitter unwanted emissions outside the 5 GHz RLAN bands shall not exceed the limits given in table 4.

In case of equipment with antenna connectors, these limits apply to emissions at the antenna port (conducted) and to the emissions radiated by the cabinet. In case of integral antenna equipment (without temporary antenna connectors), these limits apply to emissions radiated by the equipment

**Table 4: Transmitter unwanted emission limits outside the 5 GHz RLAN bands**

Frequency range	Maximum power	Bandwidth
30 MHz to 47 MHz	-36 dBm	100 kHz
47 MHz to 74 MHz	-54 dBm	100 kHz
74 MHz to 87,5 MHz	-36 dBm	100 kHz
87,5 MHz to 118 MHz	-54 dBm	100 kHz
118 MHz to 174 MHz	-36 dBm	100 kHz
174 MHz to 230 MHz	-54 dBm	100 kHz
230 MHz to 470 MHz	-36 dBm	100 kHz
470 MHz to 862 MHz	-54 dBm	100 kHz
862 MHz to 1 GHz	-36 dBm	100 kHz
1 GHz to 5,15 GHz	-30 dBm	1 MHz
5,35 GHz to 5,47 GHz	-30 dBm	1 MHz
5,725 GHz to 26 GHz	-30 dBm	1 MHz

**6.1.1 CONFORMANCE**

Conformance tests as defined in clause 5.4.5 shall be carried out.

6.1.2 TEST SETUP LAYOUT

(a) For radiated emissions below 1000MHz

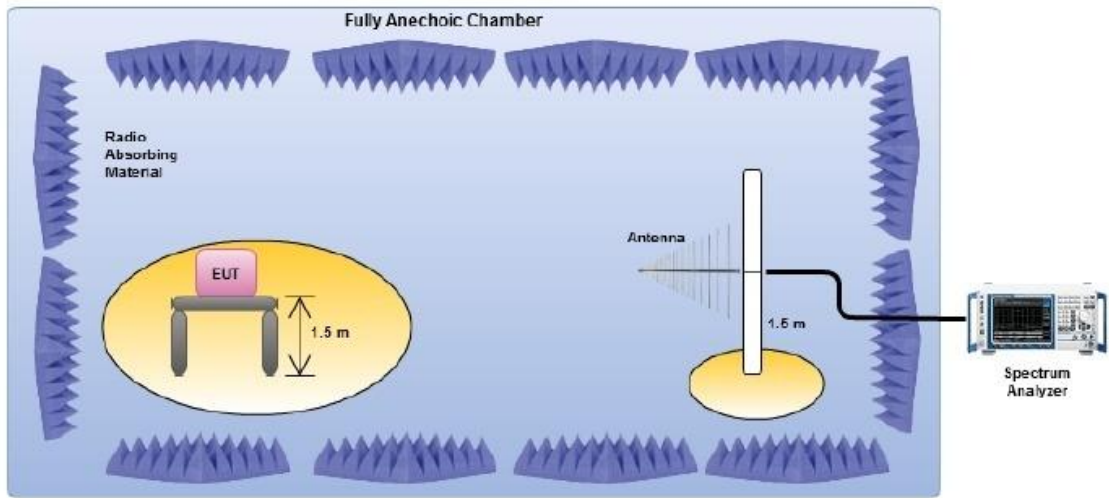

(b) For radiated emissions above 1000MHz

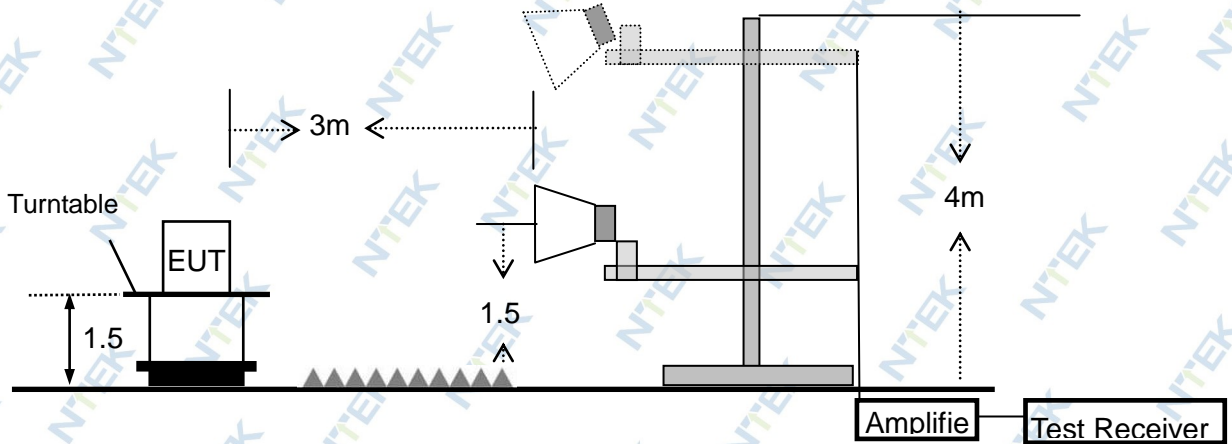



6.1.3 TEST RESULTS (30MHz ~ 1000MHz)

EUT :	4G Tablet	Model Name :	Tab 12
Temperature :	24 °C	Relative Humidity :	57%
Pressure :	1010 hPa	Test Power :	DC 3.8V
Test Mode :	TX-802.11ac20(CH36)		

Polar (H/V)	Frequency	Meter Reading	Factor	Emission Level	Limits	Margin	Remark
	(MHz)	(dBm)	(dB)	(dBm)	(dBm)	(dB)	
V	42.40	19.18	18.82	-62.22	-54	-20.46	peak
V	101.23	11.97	11.11	-72.61	-36	-20.46	peak
V	224.35	11.49	11.41	-66.22	-54	-11.55	peak
V	425.60	12.95	12.72	-66.15	-36	-29.04	peak
V	480.01	13.02	12.66	-72.16	-36	-8.39	peak
V	633.11	12.65	12.62	-68.79	-54	-20.46	peak
H	39.36	20.90	19.94	-58.06	-54	-29.08	peak
H	112.69	11.12	10.96	-71.05	-54	-7.72	peak
H	206.65	10.08	9.42	-72.85	-54	-6.16	peak
H	332.85	12.75	12.65	-64.82	-36	-29.18	peak
H	654.02	12.36	11.78	-65.46	-36	-12.00	peak
H	652.55	15.68	15.38	-67.01	-54	-22.74	peak

**Remark:**

Emission Level= Meter Reading+ Factor, Margin= Emission Level - Limit

Note: "802.11ac" is the worst mode, the test report records only the worst-case test values.

6.1.4 TEST RESULTS (1.0GHz ~26GHz)

EUT :	4G Tablet	Model Name :	Tab 12
Temperature :	24 °C	Relative Humidity :	54%
Pressure :	1010 hPa	Test Power :	DC 3.8V
Test Mode :	TX-802.11ac20 (CH36/CH40/CH48)		

Polar	Frequency	Meter Reading	Factor	Emission Level	Limits	Margin	Remark
(H/V)	(MHz)	(dBm)	(dB)	(dBm)	(dBm)	(dB)	
<b>operation frequency:5180</b>							
V	10360	-55.55	13.82	-41.73	-30	-11.73	peak
V	15540	-59.28	14.91	-44.37	-30	-14.37	peak
H	10360	-59.00	13.82	-45.18	-30	-15.18	peak
H	15540	-60.45	14.91	-45.54	-30	-15.54	peak
<b>operation frequency:5200</b>							
V	10400	-49.08	13	-36.08	-30	-6.08	peak
V	15600	-54.14	14.95	-39.19	-30	-9.19	peak
H	10400	-52.78	13	-39.78	-30	-9.78	peak
H	15600	-51.86	14.95	-36.91	-30	-6.91	peak
<b>operation frequency:5240</b>							
V	10480	-55.58	13.81	-41.77	-30	-11.77	peak
V	15720	-59.73	15.29	-44.44	-30	-14.44	peak
H	10480	-59.73	13.81	-45.92	-30	-15.92	peak
H	15720	-61.17	15.29	-45.88	-30	-15.88	peak
<b>Remark:</b>							
Emission Level= Meter Reading+ Factor, Margin= Limit- Emission Level							

Note: "802.11ac20" is the worst mode, the test report records only the worst-case test values.

## 7. TRANSMITTER UNWANTED EMISSIONS WITHIN THE 5 GHZ RLAN BANDS

### 7.1 APPLIED PROCEDURES / LIMIT

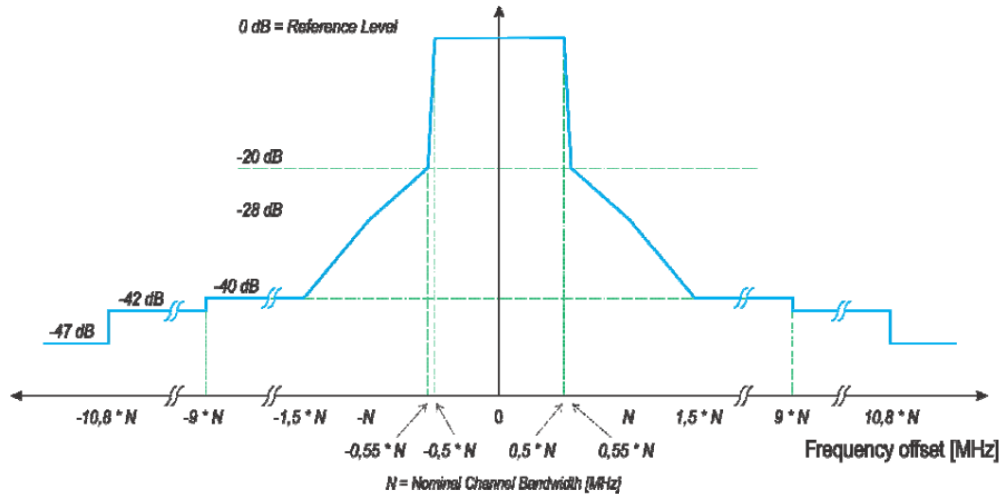

NOTE: dBc is the spectral density relative to the maximum spectral power density of the transmitted signal.

Figure 1: Transmit spectral power mask

#### 7.1.1 TEST PROCEDURES

According to ETSI EN 301 893 V2.1.1 (2017-05) §5.4.6

#### 7.1.2 TEST SETUP LAYOUT

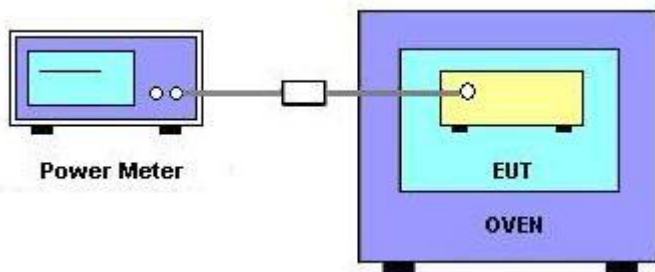



7.1.3 TEST RESULTS

EUT :	4G Tablet	Model Name :	Tab 12
Temperature :	24°C	Relative Humidity:	54 %
Pressure :	1012 hPa	Test Voltage :	DC 3.8V(NORMAL)
Test Mode :	Tx Mode-802.11(a/n20/n40/ac20/ac40/ac80)		

Test data reference attachment

**8. RECEIVER SPURIOUS EMISSIONS**

**8.1 APPLIED PROCEDURES / LIMIT**

The spurious emissions of the receiver shall not exceed the limits given in table 5.

In case of equipment with antenna connectors, these limits apply to emissions at the antenna port (conducted) and to the emissions radiated by the cabinet. In case of integral antenna equipment (without temporary antenna connectors), these limits apply to emissions radiated by the equipment.

**Table 5: Spurious radiated emission limits**

Frequency range	Maximum power	Measurement bandwidth
30 MHz to 1 GHz	-57 dBm	100 kHz
1 GHz to 26 GHz	-47 dBm	1 MHz

**8.1.1 TEST PROCEDURES**

According to ETSI EN 301 893 V2.1.1 (2017-05) §5.4.7

**8.1.2 TEST SETUP LAYOUT**

This test setup layout is the same as that shown in section 6.1.4

8.1.3 TEST RESULTS

EUT :	4G Tablet	Model Name :	Tab 12
Temperature :	24°C	Relative Humidity :	57 %
Pressure :	1012 hPa	Test Power :	DC 3.8V
Test Mode :	RX-802.11 ac(CH36)		

BELOW 1G

Polar (H/V)	Frequency	Meter Reading	Factor	Emission Level	Limits	Margin	Remark
	(MHz)	(dBm)	(dB)	(dBm)	(dBm)	(dB)	
V	34.41	-79.09	12.96	-66.13	-57	-9.13	peak
V	96.79	-79.09	11.62	-67.47	-57	-10.47	peak
V	196.59	-84.13	18.93	-65.20	-57	-8.20	peak
V	446.53	-81.39	11.64	-69.75	-57	-12.75	peak
V	485.46	-79.89	11.47	-68.42	-57	-11.42	peak
V	717.55	-82.10	11.42	-70.68	-57	-13.68	peak
H	33.45	-84.41	18.62	-65.79	-57	-8.79	peak
H	90.05	-86.66	18.13	-68.53	-57	-11.53	peak
H	203.37	-81.92	10.36	-71.56	-57	-14.56	peak
H	245.57	-79.64	14.01	-65.63	-57	-8.63	peak
H	681.30	-83.81	14.11	-69.70	-57	-12.70	peak
H	727.50	-78.93	14.61	-64.32	-57	-7.32	peak

**Remark:**

Emission Level= Meter Reading+ Factor, Margin= Emission Level - Limit

ABOVE 1G

Polar (H/V)	Frequency	Meter Reading	Factor	Emission Level	Limits	Margin	Remark
	(MHz)	(dBm)	(dB)	(dBm)	(dBm)	(dB)	
V	1299.65	-83.87	9.94	-73.93	-47	-26.93	peak
V	2671.49	-84.73	9.82	-74.91	-47	-27.91	peak
V	3014.93	-80.30	10.02	-70.28	-47	-23.28	peak
V	4357.91	-81.63	16.13	-65.50	-47	-18.50	peak
V	4450.89	-82.80	16.13	-66.67	-47	-19.67	peak
V	4937.45	-82.41	16.13	-66.28	-47	-19.28	peak
H	2073.43	-79.12	10.11	-69.01	-47	-22.01	peak
H	2935.39	-85.61	10.68	-74.93	-47	-27.93	peak
H	3077.82	-80.71	10.21	-70.50	-47	-23.50	peak
H	3704.62	-79.43	11.23	-68.20	-47	-21.20	peak
H	4009.99	-84.14	8.60	-75.54	-47	-28.54	peak
H	5910.55	-77.86	14.56	-63.30	-47	-16.30	peak

**Remark:**

Emission Level= Meter Reading+ Factor, Margin= Emission Level - Limit

Note: "802.11a" is the worst mode, the test report records only the worst-case test values.



**9. ADAPTIVITY (CHANNEL ACCESS MECHANISM)**

**9.1 APPLICABILITY OF ADAPTIVE REQUIREMENTS AND LILIT**

This requirement applies to equipment, testing shall be performed using the highest nominal channel Bandwidth. The manufacturer shall state whether the UUT is capable of operating as a Frame Based Equipment or Load Based Equipment. See tables for the applicability of adaptive requirements and limit for each of the operational modes.

**Applicability of adaptive requirements and limit**

Requirement	Operational Mode		
	Frame Based Equipment	Load Based Equipment (CCA using 'energy detect')	Load Based Equipment (CCA not using any of the mechanisms referenced)
Minimum Clear Channel Assessment (CCA) Time	20 us (see note 1)	(see note 2)	20 us (see note 1)
Maximum Channel Occupancy (COT) Time	1ms to 10 ms	(see note 2)	(13/32)*q ms (see note 3)
Minimum Idle Period	5% of COT	(see note 2)	NA
Extended CCA check	NA	(see note 2)	N*CCA (see note 4)
Short Control Signalling Transmissions	Maximum duty cycle of 5% within an observation period of 50 ms (see note 5)		

Note 1: The CCA time used by the equipment shall be declared by the manufacturer.  
 Note 2: LBT based spectrum sharing mechanism based on the Clear Channel Assessment (CCA) mode using 'energy detect', as described in IEEE 802.11™-2007[9], clauses 15 and 17, in IEEE 802.11n™ -2009[10], clauses 20.  
 Note 3: q is selected by the manufacturer in the range [4...32]  
 Note 4: The value of N shall be randomly selected in the range [1...q]  
 Note 5: Adaptive equipment may or may not have Short Control Signaling Transmissions.

**Interference threshold level**

Maximum transmit power (P <sub>H</sub> ) EIRP dBm	Threshold Level (TL) (see note 1 and 2)
9.81	-73 dBm / MHz

Note 1: TL = -73 dBm / MHz + (23 -PH)/ (1 MHz) (assuming a 0 dBi receive antenna and PH specified in dBm e.i.r.p )  
 Note 2: Transmitter the CCA threshold level (TL) shall be equal or lower than -73 dBm / MHz at the input to the receiver (assuming a 0 dBi receive antenna).

**TEST PROCEDURE**

Reference to ETSI EN 301 893 V2.1.1 (2017-05) clause 5.4.9

9.2 TEST SETUP CONFIGURATION

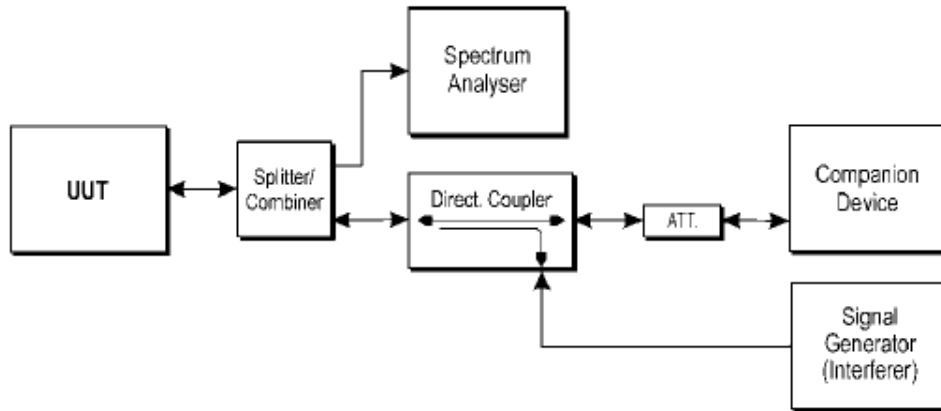

Figure 13: Example Test Set-up for verifying the adaptivity of an equipment

9.3 LIST OF MEASUREMENTS

UUT operational Mode		
Frame Based Equipment	Load Based Equipment (CCA using 'energy detect')	Load Based Equipment (CCA not using any of the mechanisms referenced)
	V	

Clause	Test Parameter	Remarks	PASS/FAIL
4.9.2.1	Adaptive (Frame Based Equipment)	Not Applicable	N/A
4.9.2.2	Adaptive (Load Based Equipment)	Applicable	PASS
4.9.2.3	Short Control Signaling Transmissions	Applicable	PASS

9.4 TEST RESULTS

EUT :	4G Tablet	Model Name :	Tab 12
Temperature :	24°C	Relative Humidity :	54 %
Pressure :	1012 hPa	Test Power :	DC 3.8V
TEST RESULTS	Pass		

Test data reference attachment

**10. RECEIVER BLOCKING**

**10.1 LIMITS OF RECEIVER BLOCKING**

**Performance Criteria**

The minimum performance criterion shall be a PER of less than or equal to 10 %. The manufacturer may declare alternative performance criteria as long as that is appropriate for the intended use of the equipment (see clause 5.4.1, item s)).

While maintaining the minimum performance criteria as defined in clause 4.2.8.3, the blocking levels at specified frequency offsets shall be equal to or greater than the limits defined in table 7.

**Table 9: Receiver Blocking parameters**

Wanted signal mean power from companion device (dBm)	Blocking signal Frequency (MHz)	Blocking signal power (dBm) (see note 2)	Type of blocking signal
P <sub>min</sub> + 6 dB	5 100	-59	CW
P <sub>min</sub> + 6 dB	4 900 5 000 5 975	-53	CW

NOTE 1: P<sub>min</sub> is the minimum level of the wanted signal (in dBm) required to meet the minimum performance criteria as defined clause 4.2.8.3 in the absence of any blocking signal.

NOTE 2: The levels specified are levels in front of the UUT antenna. In case of conducted measurements, the same levels should be used at the antenna connector irrespective of antenna gain.

**10.2 TEST PROCEDURE**

Refer to chapter 5.4.10 of ETSI EN 301 893 V2.1.1 (2017-05)

Measurement	
<input checked="" type="checkbox"/> Conducted measurement	<input type="checkbox"/> Radiated measurement

**10.3 DEVIATION FROM TEST STANDARD**

No deviation

**10.4 TEST SETUP**



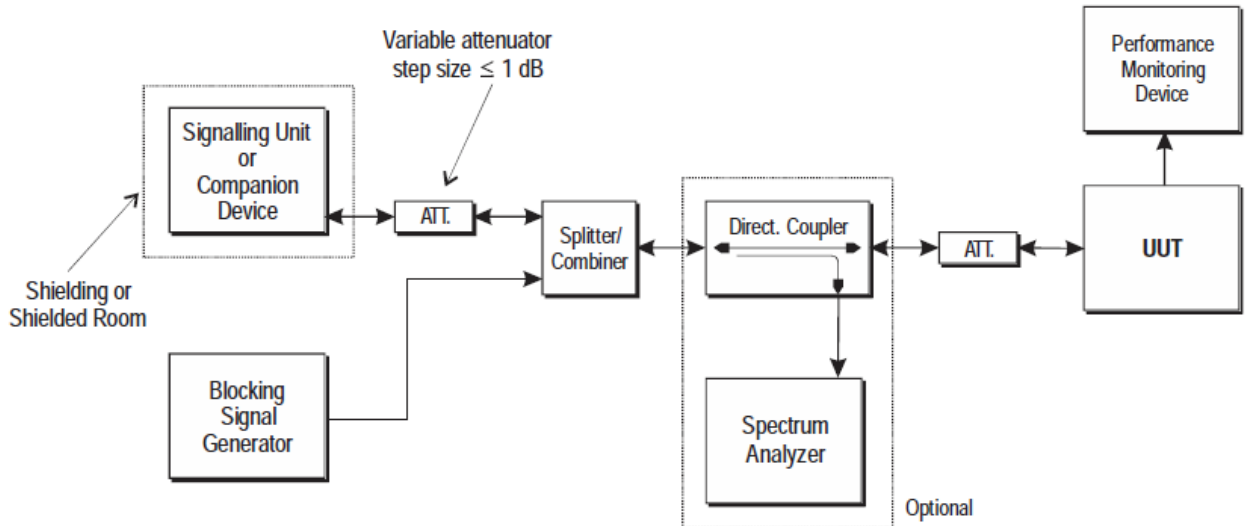

Figure 14: Test Set-up for receiver blocking

10.5 TEST RESULTS

EUT :	4G Tablet	Model Number :	Tab 12
Temperature :	24°C	Relative Humidity :	54 %
Pressure :	1012 hPa	Test Voltage :	DC 3.8V
Test Mode :	RX 802.11ac20		

CH 36-5180MHz

Wanted signal mean power from companion device (dBm) <small>Note(1)</small>	Blocking signal Frequency (MHz)	Blocking signal power (dBm)	PER % <small>Note(1)</small>	PER Limit %
-72 + 6 dB	5100	-59	0.52	≤10%
-72 + 6 dB	4900	-53	0.63	≤10%
	5000		0.72	
	5975		0.43	

Note: (1) The above results were obtained from laboratory tests.

## 11. USER ACCESS RESTRICTIONS

### 11.1 APPLIED PROCEDURES / LIMIT

The equipment shall be so constructed that settings (hardware and/or software) related to DFS shall not be accessible to the user if changing those settings result in the equipment no longer being compliant with the DFS requirements in clause 4.2.6.

The above requirement includes the prevention of indirect access to any setting that impacts DFS. The following is a non-exhaustive list of examples of such indirect access.

### 11.2 TEST RESULTS

The EUT is accord with User Access Restrictions

## 12. GEO-LOCATION CAPABILITY

### 12.1 APPLIED PROCEDURES / LIMIT

The geographic location determined by the equipment as defined in clause 4.2.10.2 shall not be accessible to the user.

If the equipment cannot determine the geographic location, it shall operate in a mode compliant with the requirements applicable in any of the geographic locations where the equipment is intended to operate.

### 12.2 TEST RESULTS

The EUT is accord with Geo-location capability

### 13 TEST RESULTS

#### 13.1 OCCUPIED CHANNEL BANDWIDTH

Condition	Mode	Frequency (MHz)	Center Frequency (MHz)	OBW (MHz)	Lower Limit (MHz)	Upper Limit (MHz)	Verdict
NVNT	802.11a	5180	5179.978	16.474	16	20	Pass
NVNT	802.11ac20	5180	5179.974	17.666	16	20	Pass
NVNT	802.11ac40	5190	5189.88	35.996	32	40	Pass
NVNT	802.11ac80	5210	5209.856	75.64	64	80	Pass
NVNT	802.11n(HT20)	5180	5179.972	17.662	16	20	Pass
NVNT	802.11n(HT40)	5190	5189.88	35.996	32	40	Pass

OBW NVNT 802.11a 5180MHz

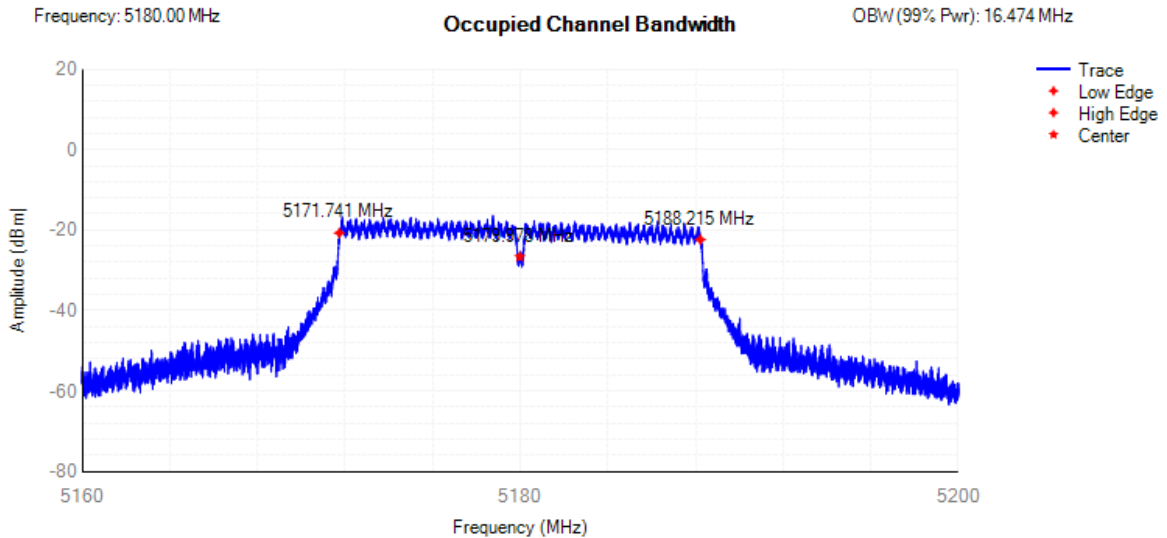

OBW NVNT 802.11ac20 5180MHz

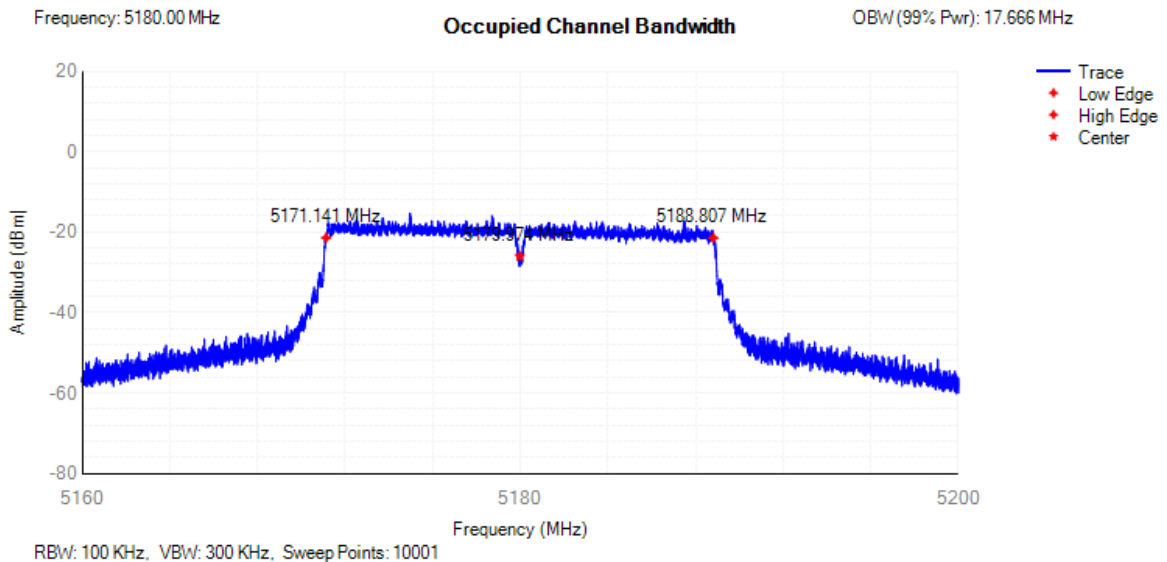



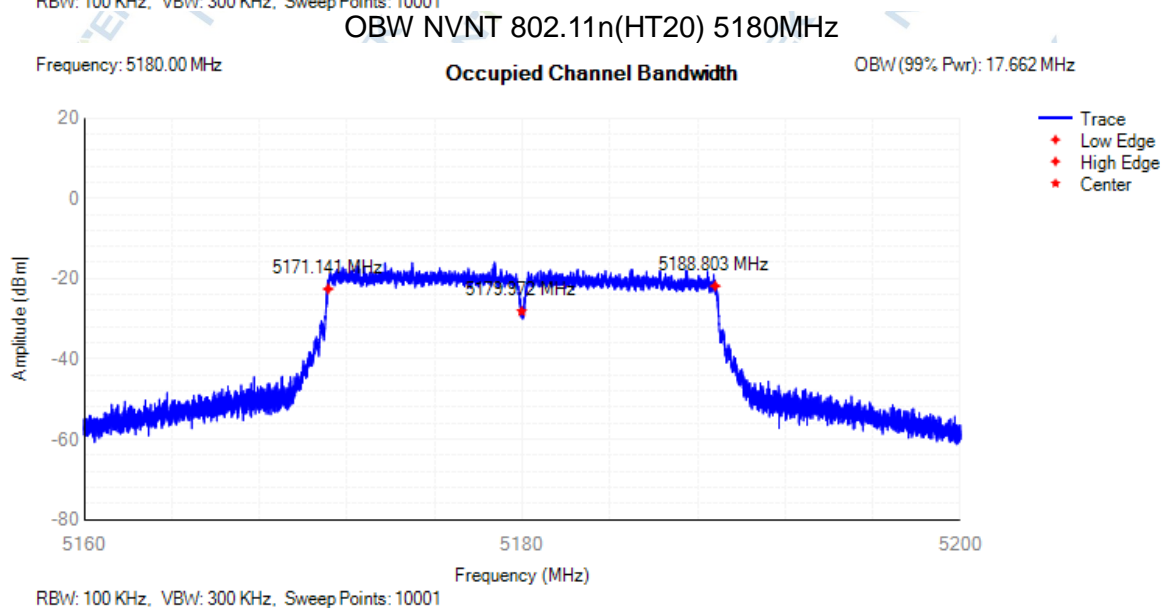
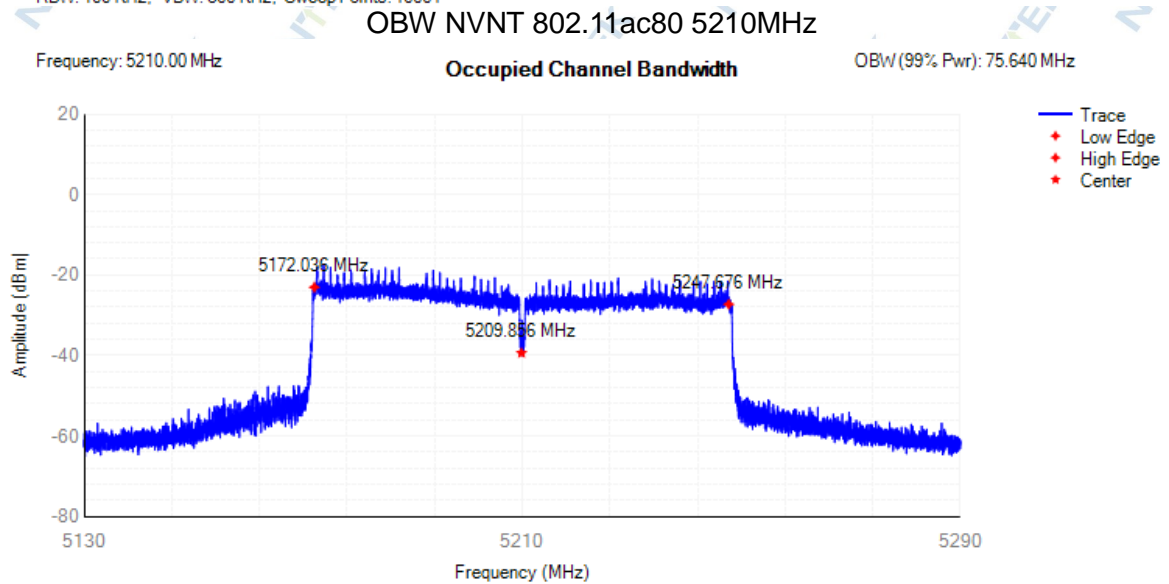
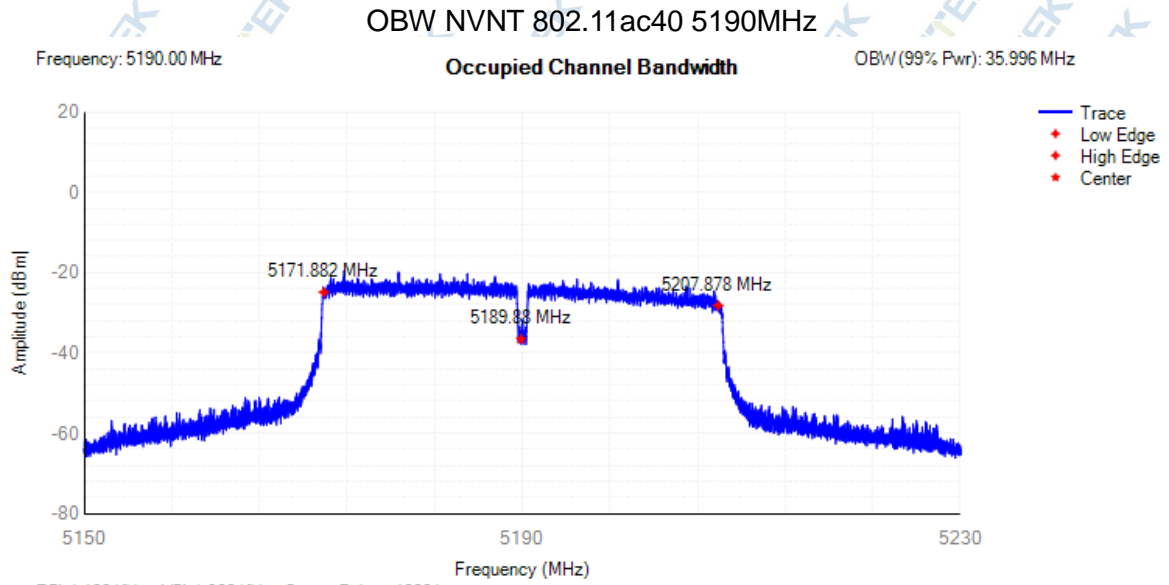

OBW NVNT 802.11n(HT40) 5190MHz

Frequency: 5190.00 MHz

Occupied Channel Bandwidth

OBW (99% Pwr): 35.996 MHz

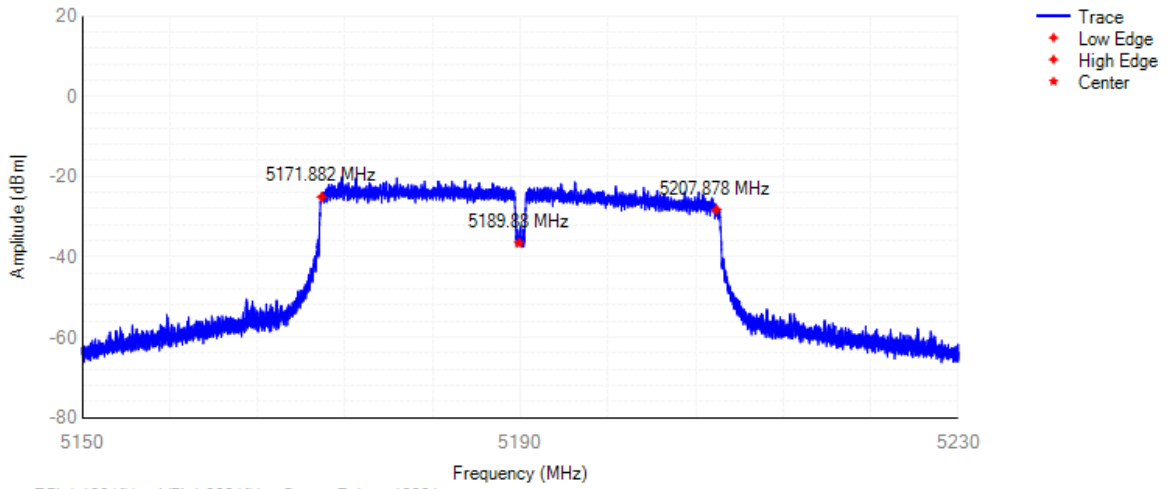

RBW: 100 KHz, VBW: 300 KHz, Sweep Points: 10001

13.2 RF OUTPUT POWER

Condition	Mode	Frequency (MHz)	Max Burst RMS Power (dBm)	Burst Number	Max EIRP (dBm)	Limit (dBm)	Verdict
NVNT	802.11a	5180	8.06	67	9.47	23	Pass
NVNT	802.11ac20	5180	8.48	78	9.89	23	Pass
NVNT	802.11ac40	5190	6.63	142	8.04	23	Pass
NVNT	802.11ac80	5210	6.06	247	7.47	23	Pass
NVNT	802.11n(HT20)	5180	8.08	79	9.49	23	Pass
NVNT	802.11n(HT40)	5190	7.03	143	8.44	23	Pass
NVLT	802.11a	5180	7.62	67	9.03	23	Pass
NVLT	802.11ac20	5180	8.22	78	9.63	23	Pass
NVLT	802.11ac40	5190	6.37	142	7.78	23	Pass
NVLT	802.11ac80	5210	5.8	247	7.21	23	Pass
NVLT	802.11n(HT20)	5180	7.82	79	9.23	23	Pass
NVLT	802.11n(HT40)	5190	6.77	143	8.18	23	Pass
NVHT	802.11a	5180	7.75	67	9.16	23	Pass
NVHT	802.11ac20	5180	7.96	78	9.37	23	Pass
NVHT	802.11ac40	5190	6.11	142	7.52	23	Pass
NVHT	802.11ac80	5210	5.54	247	6.95	23	Pass
NVHT	802.11n(HT20)	5180	7.56	79	8.97	23	Pass
NVHT	802.11n(HT40)	5190	6.51	143	7.92	23	Pass

Power NVNT 802.11a 5180MHz

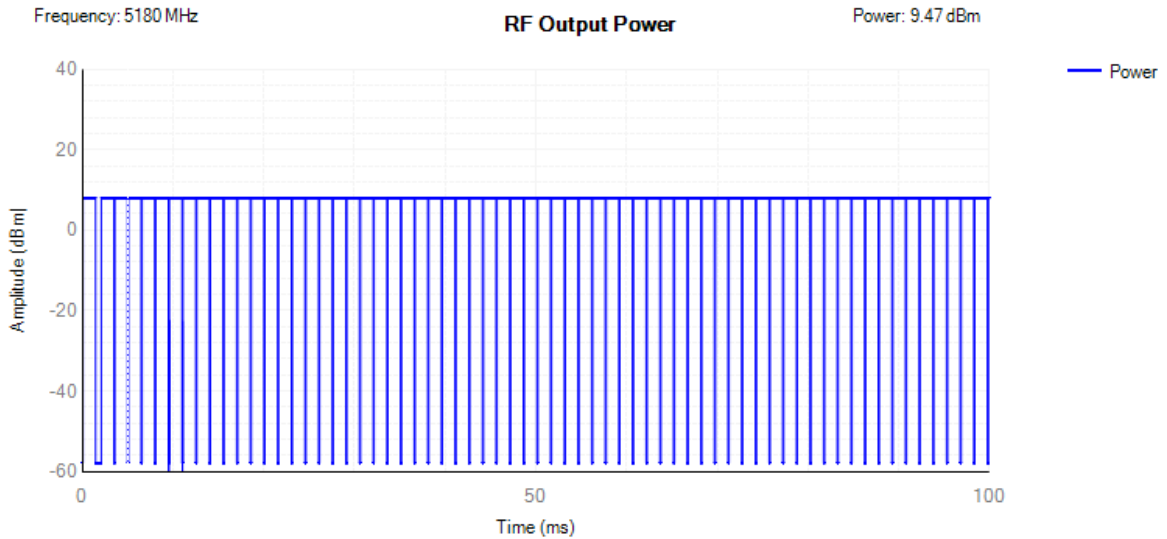

Power NVNT 802.11ac20 5180MHz

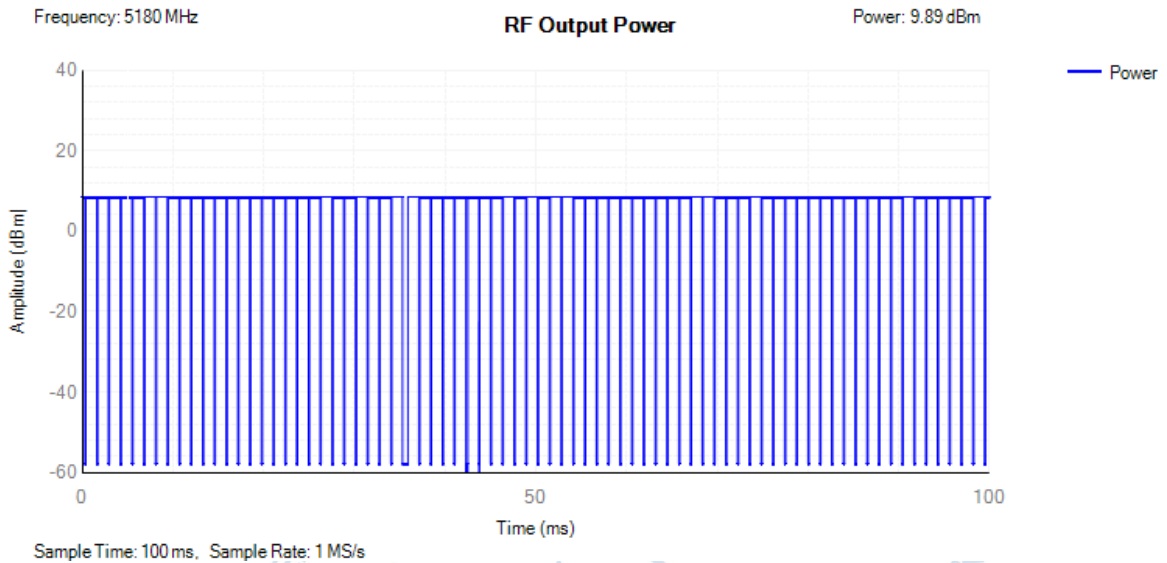



Power NVNT 802.11ac40 5190MHz

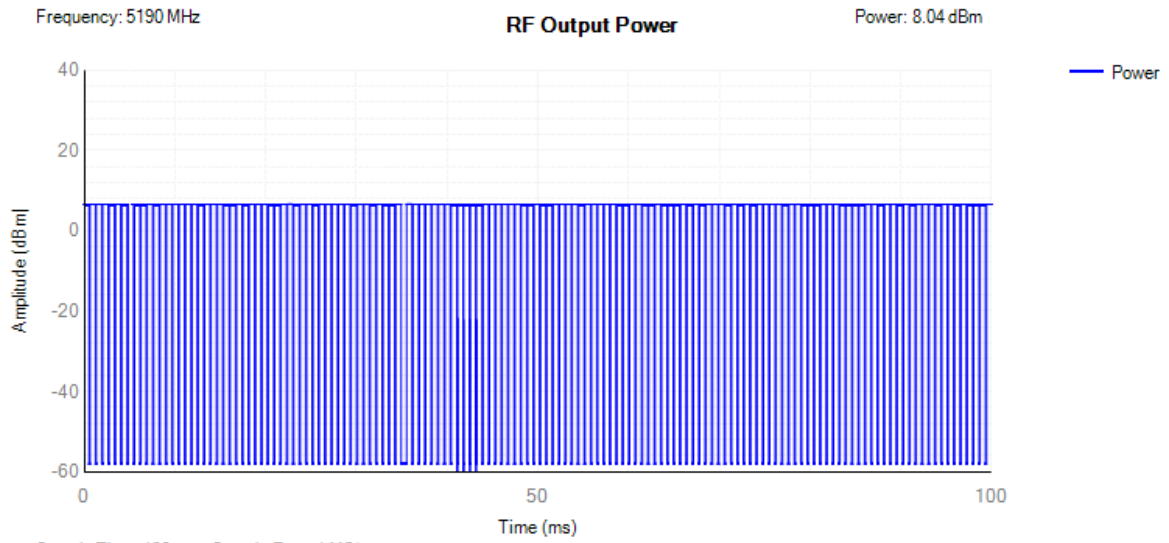

Power NVNT 802.11ac80 5210MHz

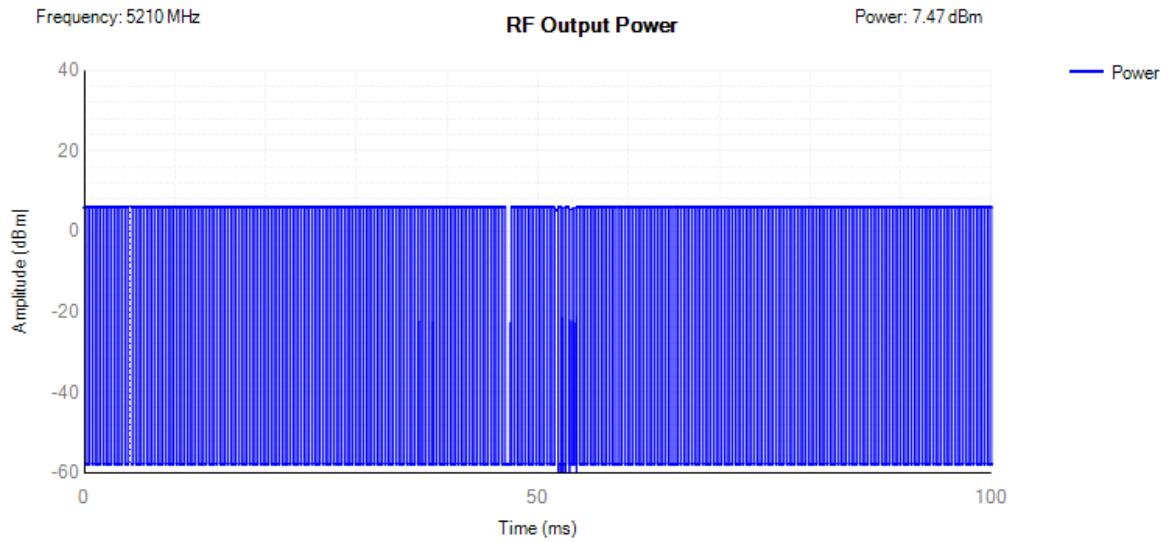

Power NVNT 802.11n(HT20) 5180MHz

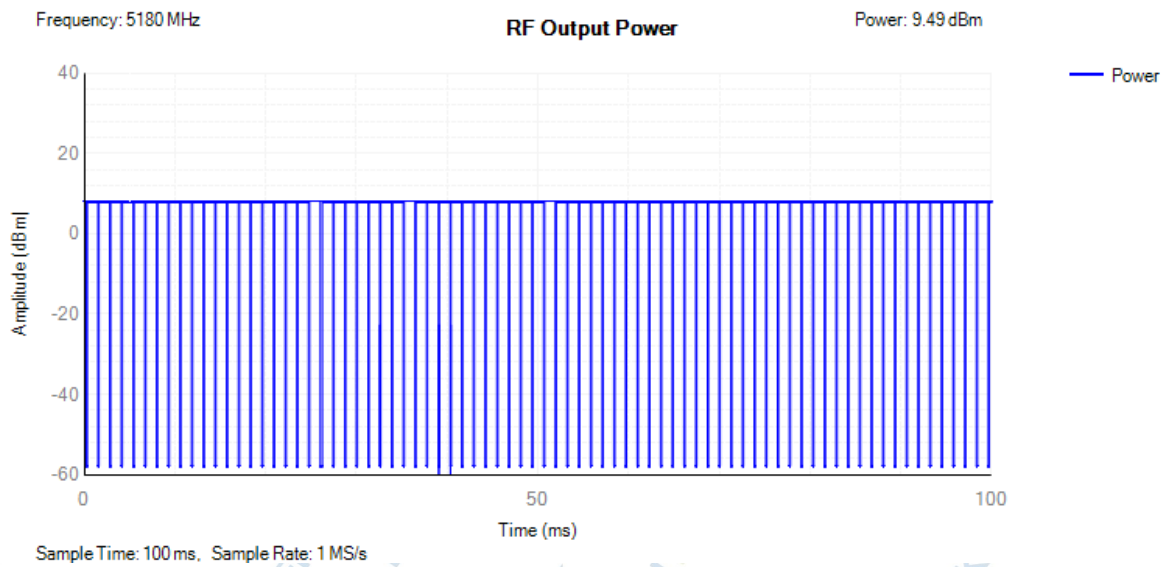

Power NVNT 802.11n(HT40) 5190MHz

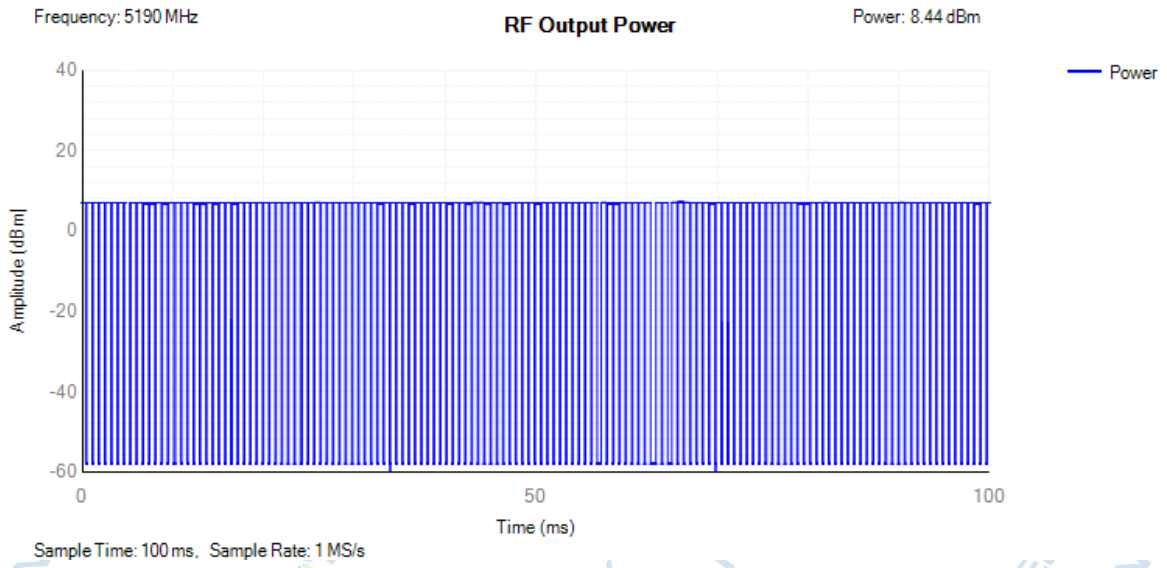

**13.3 POWER SPECTRAL DENSITY**

Condition	Mode	Frequency (MHz)	Max PSD (dBm/MHz)	Limit (dBm/MHz)	Verdict
NVNT	802.11a	5180	-2.84	10	Pass
NVNT	802.11ac20	5180	-2.65	10	Pass
NVNT	802.11ac40	5190	-7.21	10	Pass
NVNT	802.11ac80	5210	-9.65	10	Pass
NVNT	802.11n(HT20)	5180	-2.84	10	Pass
NVNT	802.11n(HT40)	5190	-6.7	10	Pass

PSD NVNT 802.11a 5180MHz

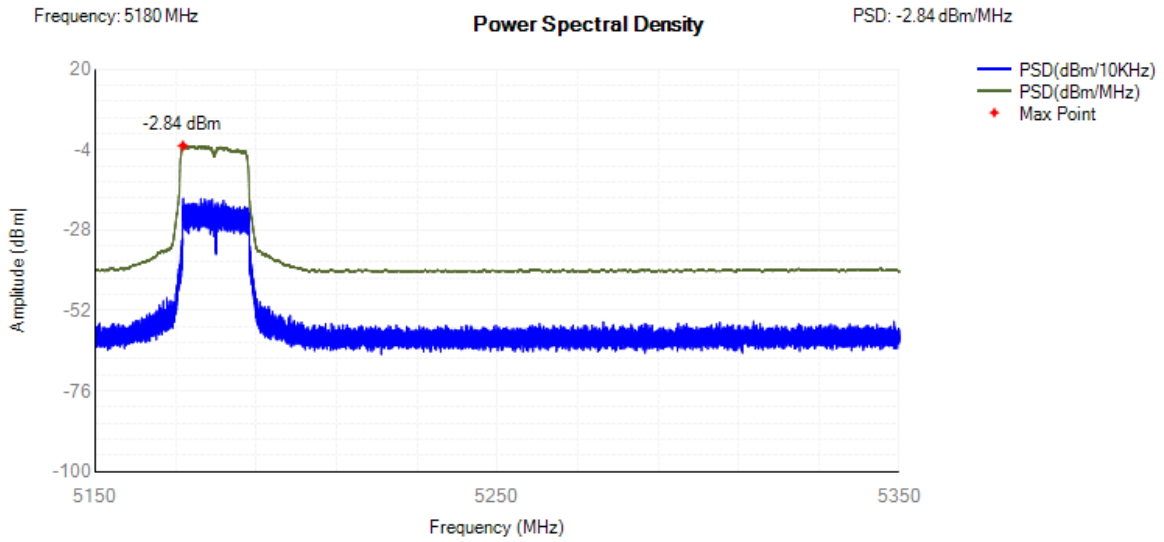

PSD NVNT 802.11ac20 5180MHz

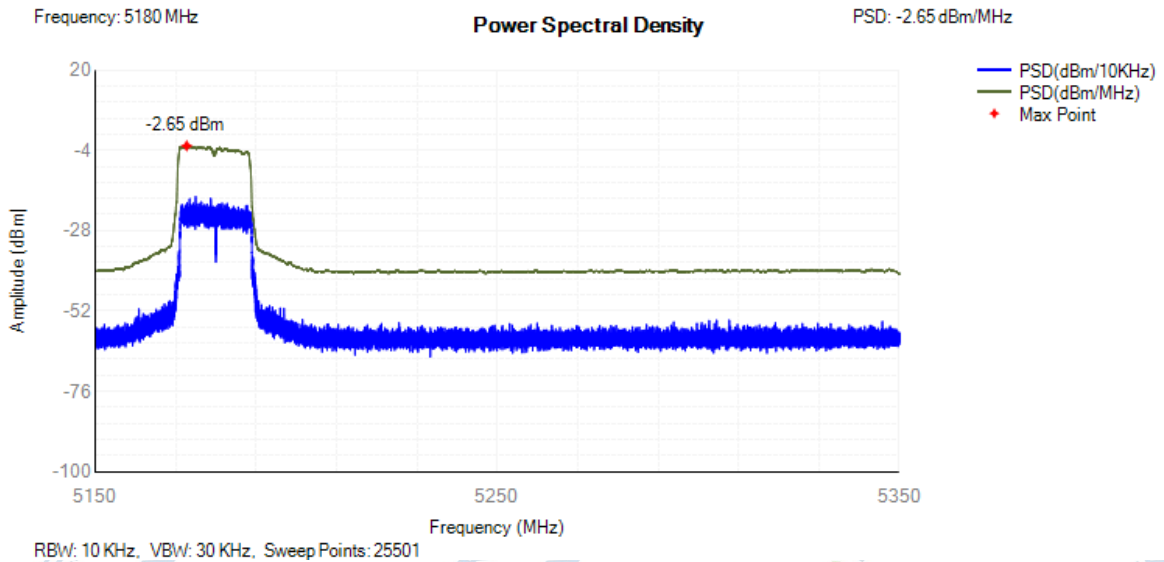



PSD NVNT 802.11ac40 5190MHz

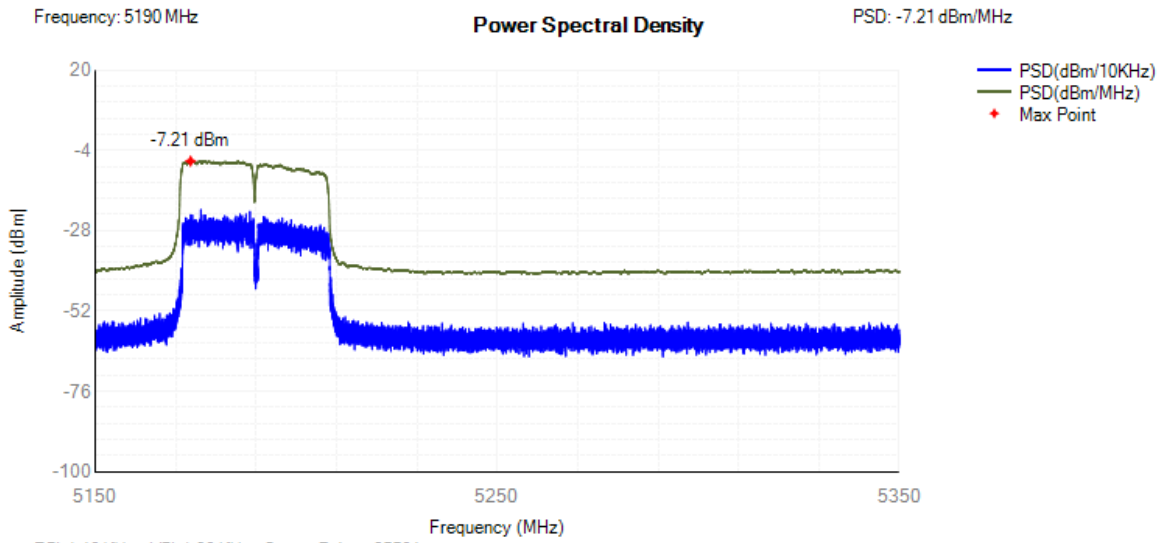

PSD NVNT 802.11ac80 5210MHz

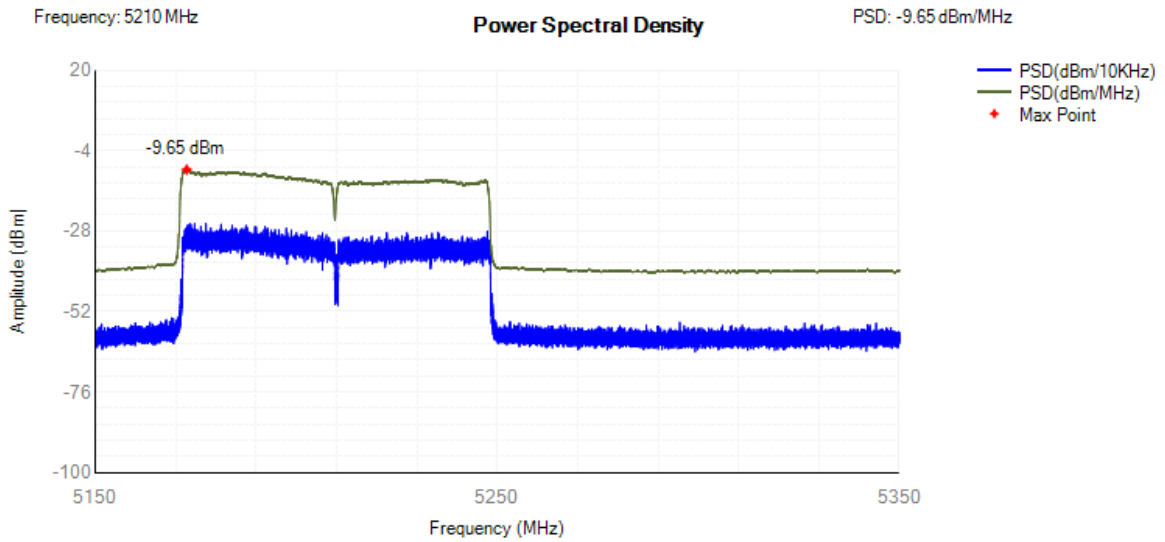

PSD NVNT 802.11n(HT20) 5180MHz

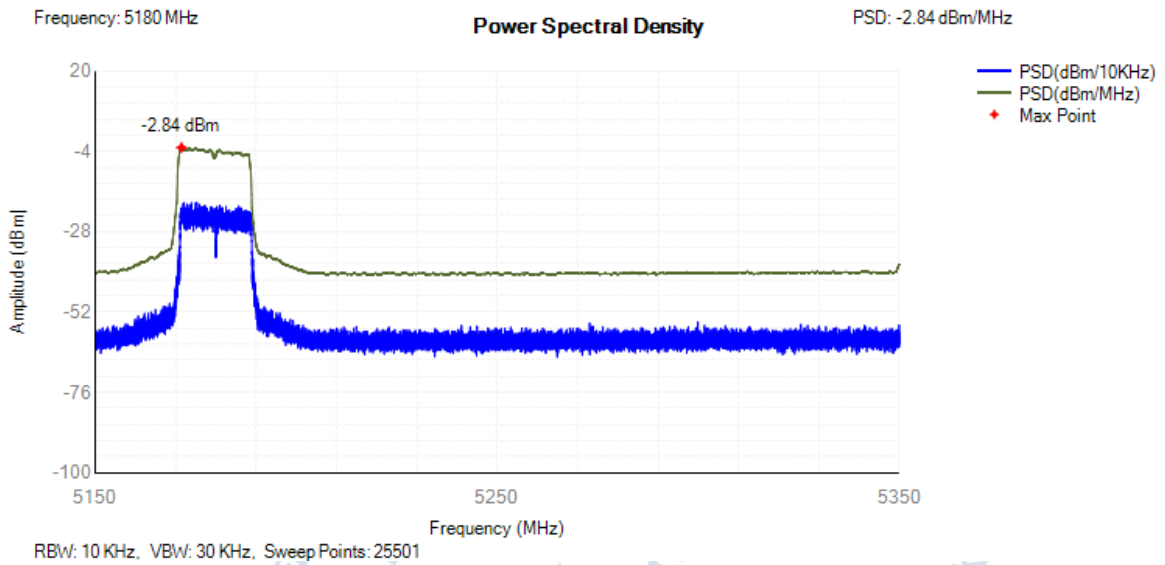

PSD NVNT 802.11n(HT40) 5190MHz

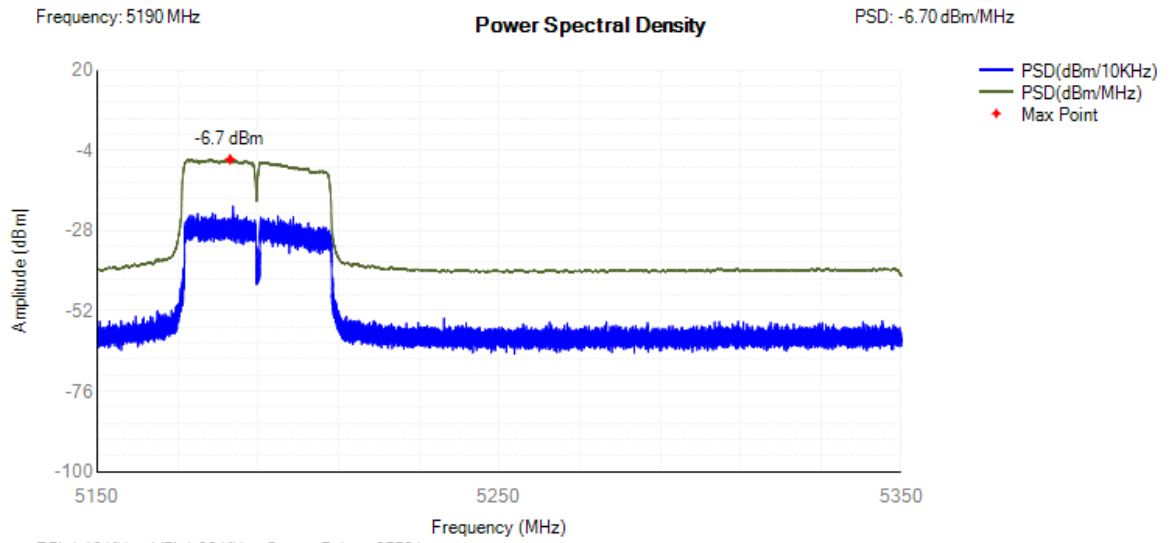

RBW: 10 KHz, VBW: 30 KHz, Sweep Points: 25501

**13.4 TRANSMITTER UNWANTED EMISSIONS IN THE SPURIOUS DOMAIN**

Condition	Mode	Frequency (MHz)	Range	Spur Freq (MHz)	Spur Level Peak(dBm)	Spur Level RMS(dBm)	Limit (dBm)	Verdict
NVNT	802.11a	5180	30 MHz -47 MHz	41.3	-76.01	NA	-36	Pass
NVNT	802.11a	5180	47 MHz -74 MHz	51.2	-76.54	NA	-54	Pass
NVNT	802.11a	5180	74 MHz -87.5 MHz	75.1	-76.55	NA	-36	Pass
NVNT	802.11a	5180	87.5 MHz -118 MHz	96.5	-75.91	NA	-54	Pass
NVNT	802.11a	5180	118 MHz -174 MHz	146	-74.49	NA	-36	Pass
NVNT	802.11a	5180	174 MHz -230 MHz	178.9	-74.9	NA	-54	Pass
NVNT	802.11a	5180	230 MHz -470 MHz	387.8	-74.4	NA	-36	Pass
NVNT	802.11a	5180	470 MHz -862 MHz	830.8	-71.16	NA	-54	Pass
NVNT	802.11a	5180	862 MHz -1000 MHz	975.7	-66.17	NA	-36	Pass
NVNT	802.11a	5180	1000 MHz -5150 MHz	5149	-41.06	NA	-30	Pass
NVNT	802.11a	5180	5350 MHz -5470 MHz	5424	-58.52	NA	-30	Pass
NVNT	802.11a	5180	5725 MHz -26000 MHz	8288	-44.39	NA	-30	Pass
NVNT	802.11ac20	5180	30 MHz -47 MHz	30.4	-65.71	NA	-36	Pass
NVNT	802.11ac20	5180	47 MHz -74 MHz	66.4	-65.55	NA	-54	Pass
NVNT	802.11ac20	5180	74 MHz -87.5 MHz	75.8	-65.61	NA	-36	Pass
NVNT	802.11ac20	5180	87.5 MHz -118 MHz	116.7	-65.61	NA	-54	Pass
NVNT	802.11ac20	5180	118 MHz -174 MHz	149.8	-65.1	NA	-36	Pass
NVNT	802.11ac20	5180	174 MHz -230 MHz	217.6	-64.57	NA	-54	Pass
NVNT	802.11ac20	5180	230 MHz -470 MHz	258.7	-64.56	NA	-36	Pass
NVNT	802.11ac20	5180	470 MHz -862 MHz	500.5	-64.29	NA	-54	Pass
NVNT	802.11ac20	5180	862 MHz -1000 MHz	956.1	-63.81	NA	-36	Pass
NVNT	802.11ac20	5180	1000 MHz -5150 MHz	5149	-38.17	NA	-30	Pass
NVNT	802.11ac20	5180	5350 MHz -5470 MHz	5435	-48.45	NA	-30	Pass
NVNT	802.11ac20	5180	5725 MHz -26000 MHz	8288	-42.97	NA	-30	Pass
NVNT	802.11ac40	5190	30 MHz -47 MHz	38.8	-66.49	NA	-36	Pass
NVNT	802.11ac40	5190	47 MHz -74 MHz	51.6	-65.99	NA	-54	Pass
NVNT	802.11ac40	5190	74 MHz -87.5 MHz	76.5	-66.19	NA	-36	Pass
NVNT	802.11ac40	5190	87.5 MHz -118 MHz	115.7	-65.89	NA	-54	Pass
NVNT	802.11ac40	5190	118 MHz -174 MHz	139.2	-65.47	NA	-36	Pass
NVNT	802.11ac40	5190	174 MHz -230 MHz	214.4	-64.53	NA	-54	Pass
NVNT	802.11ac40	5190	230 MHz -470 MHz	305.5	-64.31	NA	-36	Pass
NVNT	802.11ac40	5190	470 MHz -862 MHz	855.4	-64.65	NA	-54	Pass
NVNT	802.11ac40	5190	862 MHz -1000 MHz	901.5	-63.83	NA	-36	Pass
NVNT	802.11ac40	5190	1000 MHz -5150 MHz	5147	-38	NA	-30	Pass
NVNT	802.11ac40	5190	5350 MHz -5470 MHz	5446	-48.26	NA	-30	Pass
NVNT	802.11ac40	5190	5725 MHz -26000 MHz	8304	-41.85	NA	-30	Pass
NVNT	802.11ac80	5210	30 MHz -47 MHz	32.7	-66.46	NA	-36	Pass
NVNT	802.11ac80	5210	47 MHz -74 MHz	62	-66	NA	-54	Pass
NVNT	802.11ac80	5210	74 MHz -87.5 MHz	87.1	-65.91	NA	-36	Pass
NVNT	802.11ac80	5210	87.5 MHz -118 MHz	114.7	-65.13	NA	-54	Pass
NVNT	802.11ac80	5210	118 MHz -174 MHz	131.7	-65.44	NA	-36	Pass
NVNT	802.11ac80	5210	174 MHz -230 MHz	217.3	-64.72	NA	-54	Pass
NVNT	802.11ac80	5210	230 MHz -470 MHz	338.4	-64.04	NA	-36	Pass
NVNT	802.11ac80	5210	470 MHz -862 MHz	857.3	-63.11	NA	-54	Pass
NVNT	802.11ac80	5210	862 MHz -1000 MHz	999.1	-63.49	NA	-36	Pass
NVNT	802.11ac80	5210	1000 MHz -5150 MHz	5148	-36.65	NA	-30	Pass
NVNT	802.11ac80	5210	5350 MHz -5470 MHz	5418	-48.62	NA	-30	Pass
NVNT	802.11ac80	5210	5725 MHz -26000 MHz	8336	-41.34	NA	-30	Pass
NVNT	802.11n(HT20)	5180	30 MHz -47 MHz	36.4	-65.93	NA	-36	Pass
NVNT	802.11n(HT20)	5180	47 MHz -74 MHz	59.4	-65.96	NA	-54	Pass
NVNT	802.11n(HT20)	5180	74 MHz -87.5 MHz	80.4	-65.84	NA	-36	Pass
NVNT	802.11n(HT20)	5180	87.5 MHz -118 MHz	106.6	-65.05	NA	-54	Pass
NVNT	802.11n(HT20)	5180	118 MHz -174 MHz	124.1	-65.57	NA	-36	Pass
NVNT	802.11n(HT20)	5180	174 MHz -230 MHz	188.8	-65.23	NA	-54	Pass
NVNT	802.11n(HT20)	5180	230 MHz -470 MHz	329.9	-64.42	NA	-36	Pass
NVNT	802.11n(HT20)	5180	470 MHz -862 MHz	735.8	-64.13	NA	-54	Pass
NVNT	802.11n(HT20)	5180	862 MHz -1000 MHz	940.9	-63.55	NA	-36	Pass
NVNT	802.11n(HT20)	5180	1000 MHz -5150 MHz	5149	-38.79	NA	-30	Pass
NVNT	802.11n(HT20)	5180	5350 MHz -5470 MHz	5358	-48.76	NA	-30	Pass
NVNT	802.11n(HT20)	5180	5725 MHz -26000 MHz	8288	-42.65	NA	-30	Pass
NVNT	802.11n(HT40)	5190	30 MHz -47 MHz	34.1	-65.82	NA	-36	Pass
NVNT	802.11n(HT40)	5190	47 MHz -74 MHz	65.9	-66.2	NA	-54	Pass
NVNT	802.11n(HT40)	5190	74 MHz -87.5 MHz	82.3	-66.2	NA	-36	Pass
NVNT	802.11n(HT40)	5190	87.5 MHz -118 MHz	102.6	-66.07	NA	-54	Pass
NVNT	802.11n(HT40)	5190	118 MHz -174 MHz	166.8	-64.95	NA	-36	Pass
NVNT	802.11n(HT40)	5190	174 MHz -230 MHz	224	-64.66	NA	-54	Pass
NVNT	802.11n(HT40)	5190	230 MHz -470 MHz	403.6	-64.19	NA	-36	Pass
NVNT	802.11n(HT40)	5190	470 MHz -862 MHz	859.9	-64.12	NA	-54	Pass
NVNT	802.11n(HT40)	5190	862 MHz -1000 MHz	986.7	-63.41	NA	-36	Pass
NVNT	802.11n(HT40)	5190	1000 MHz -5150 MHz	1921	-35.37	-61.77	-30	Pass
NVNT	802.11n(HT40)	5190	5350 MHz -5470 MHz	5352	-49.37	NA	-30	Pass
NVNT	802.11n(HT40)	5190	5725 MHz -26000 MHz	8304	-41.85	NA	-30	Pass



Tx. Spurious NVNT 802.11a 5180MHz

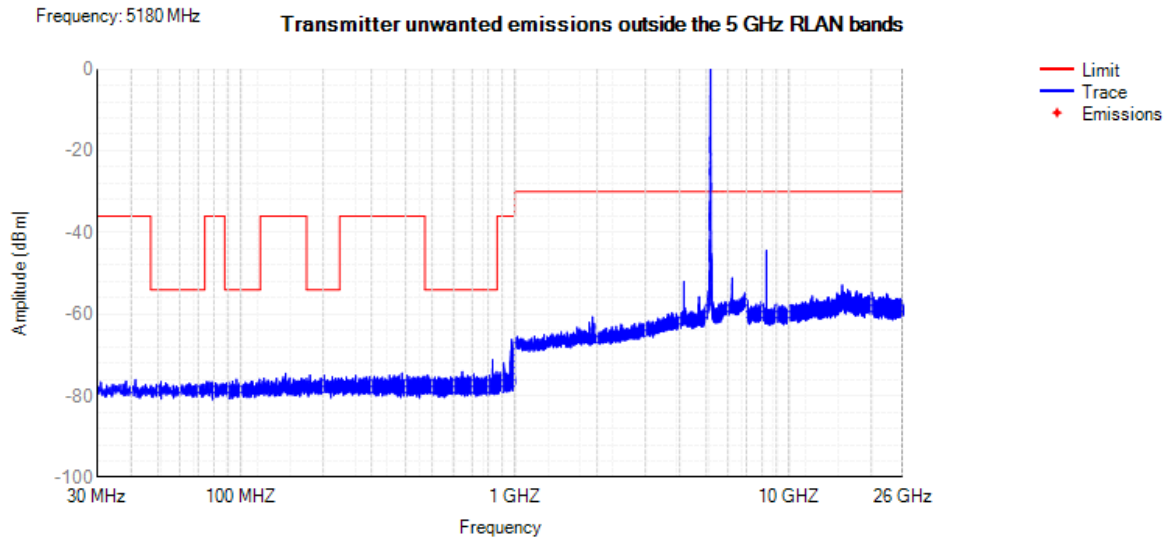

Tx. Spurious NVNT 802.11ac20 5180MHz

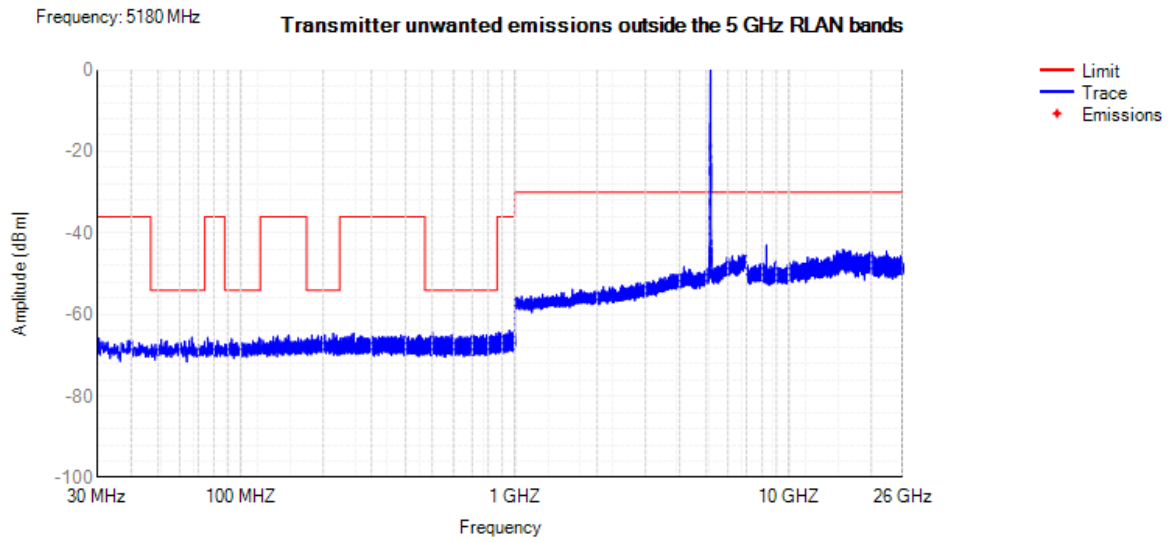

Tx. Spurious NVNT 802.11ac40 5190MHz

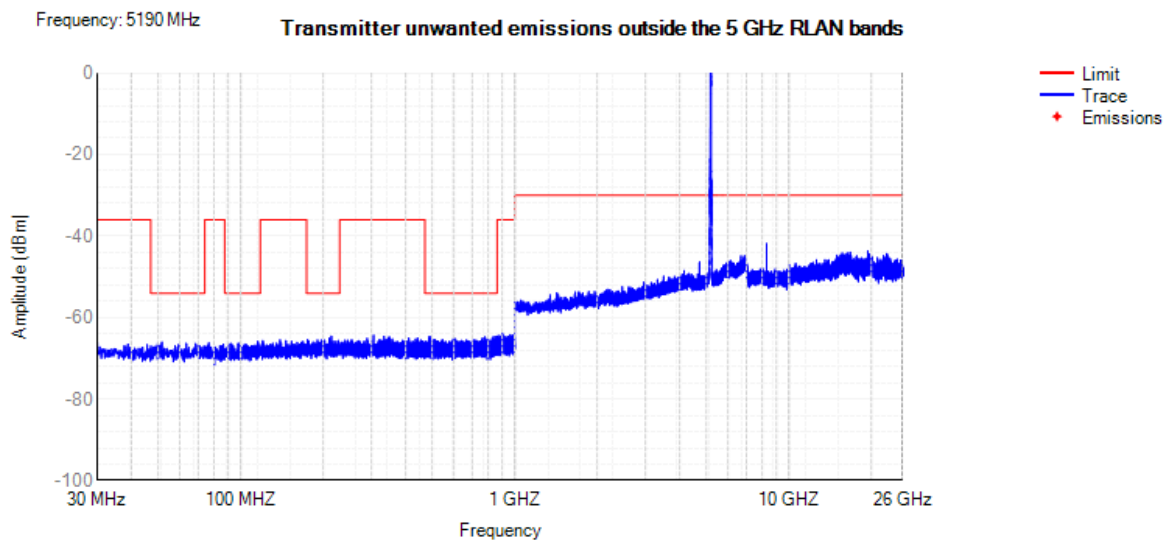

Tx. Spurious NVNT 802.11ac80 5210MHz

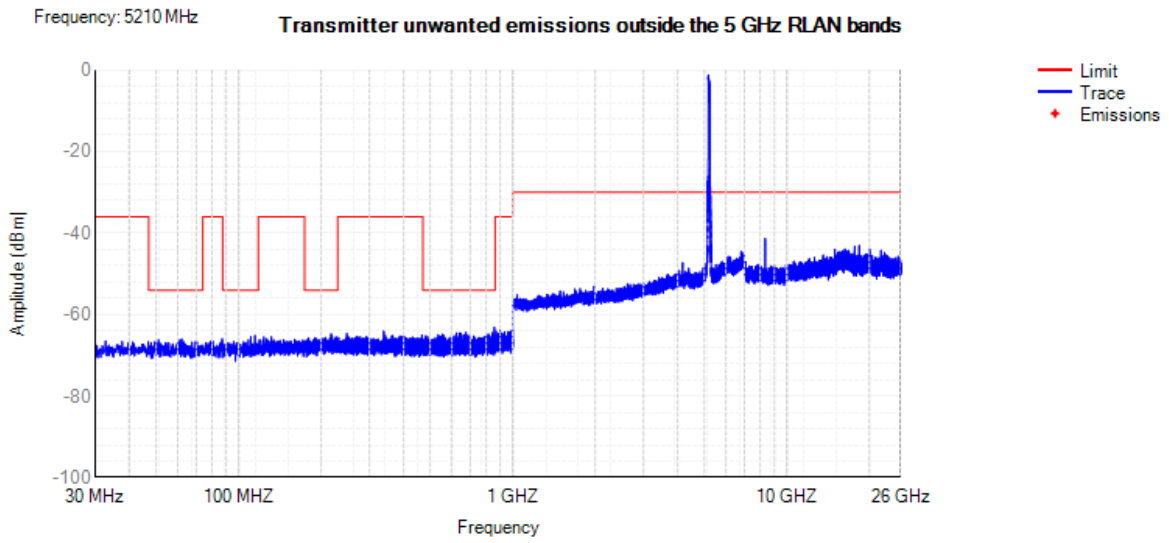

Tx. Spurious NVNT 802.11n(HT20) 5180MHz

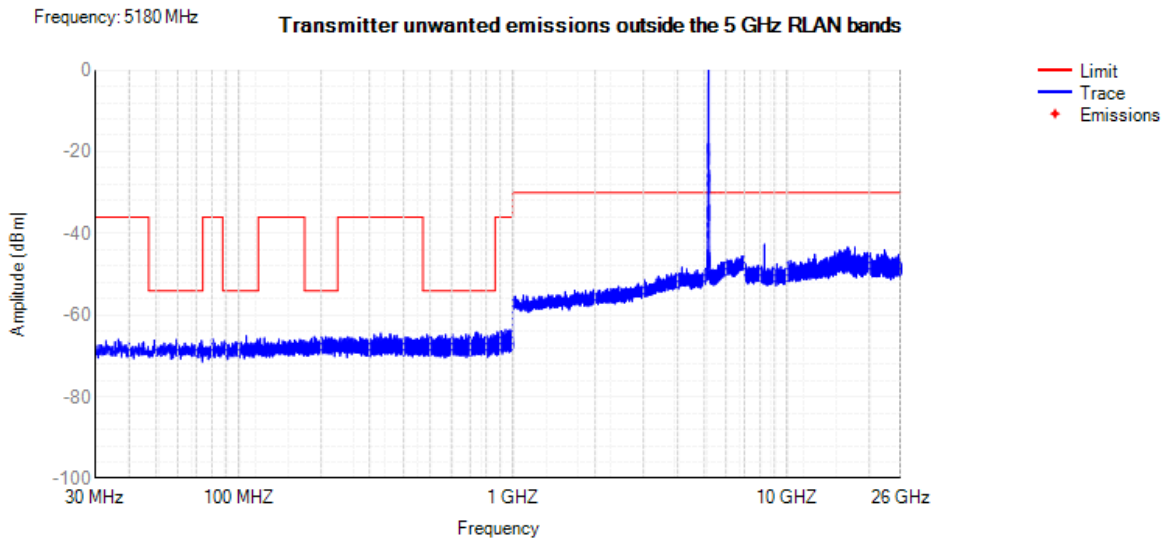

Tx. Spurious NVNT 802.11n(HT40) 5190MHz

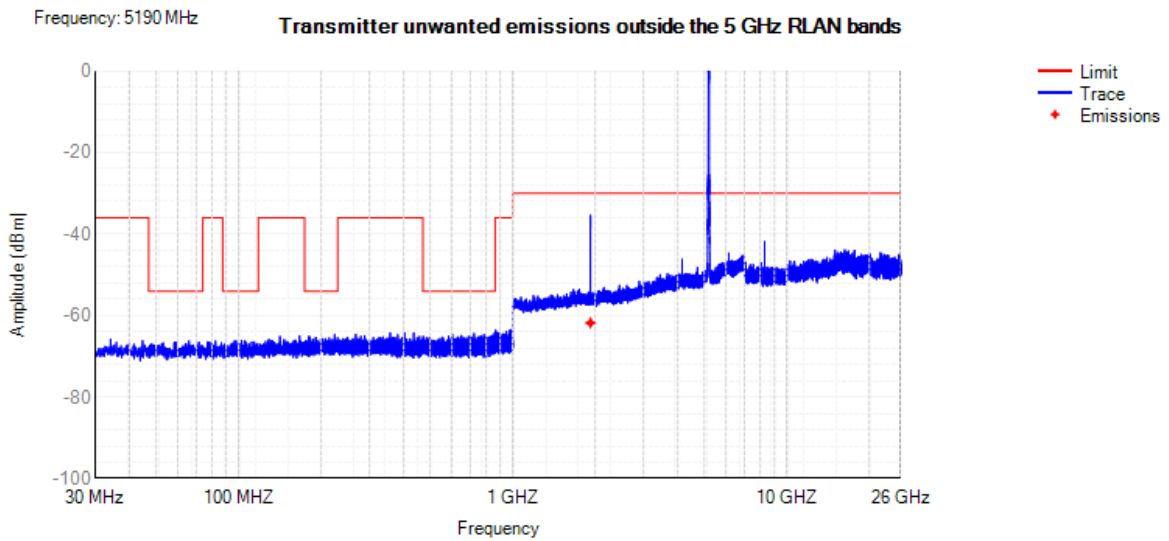

13.5 TRANSMITTER UNWANTED EMISSIONS WITHIN THE 5 GHZ RLAN BANDS

Condition	Mode	Frequency (MHz)	Sub Band	Worst EIB Frequency (MHz)	Level (dB)	Limit (dB)	Verdict
NVNT	802.11a	5180	Band1	5167.76	-32.04	-21.1	Pass
NVNT	802.11a	5180	Band2	5667.68	-63.39	-47	Pass
NVNT	802.11ac20	5180	Band1	5150.48	-49.14	-39.42	Pass
NVNT	802.11ac20	5180	Band2	5668.39	-63.03	-47	Pass
NVNT	802.11ac40	5190	Band1	5164.92	-33.08	-21.36	Pass
NVNT	802.11ac40	5190	Band2	5687.11	-56.36	-47	Pass
NVNT	802.11ac80	5210	Band1	5164.8	-32.51	-20.26	Pass
NVNT	802.11ac80	5210	Band2	5724.34	-57.96	-40	Pass
NVNT	802.11n(HT20)	5180	Band1	5161.72	-36.03	-26.47	Pass
NVNT	802.11n(HT20)	5180	Band2	5668.13	-63.1	-47	Pass
NVNT	802.11n(HT40)	5190	Band1	5165.64	-32.73	-21.04	Pass
NVNT	802.11n(HT40)	5190	Band2	5686.7	-56.39	-47	Pass

Tx. Emissions EIB NVNT 802.11a 5180MHz Sub Band1

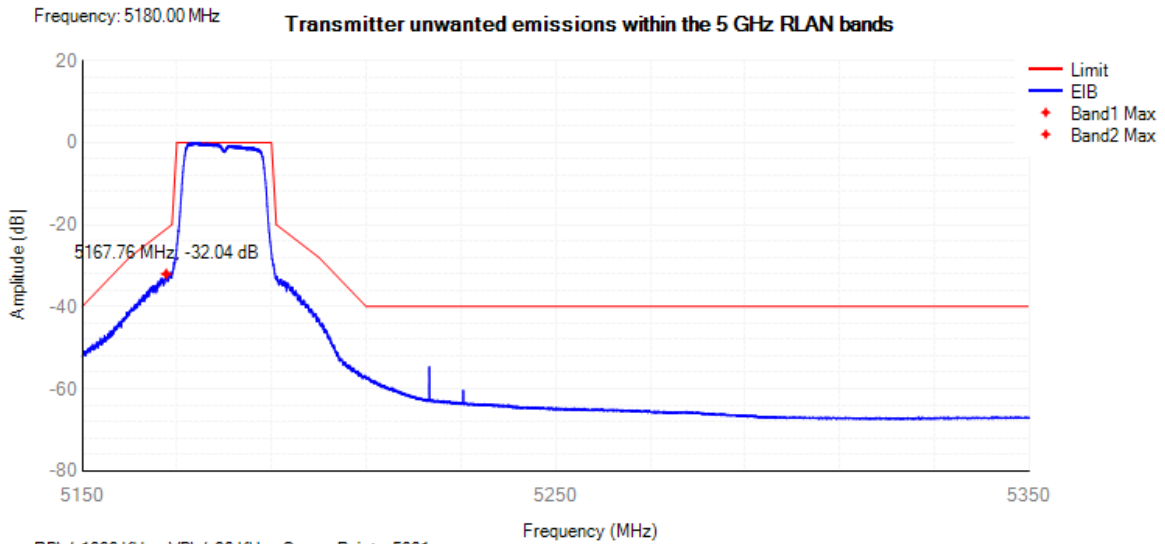

Tx. Emissions EIB NVNT 802.11a 5180MHz Sub Band2

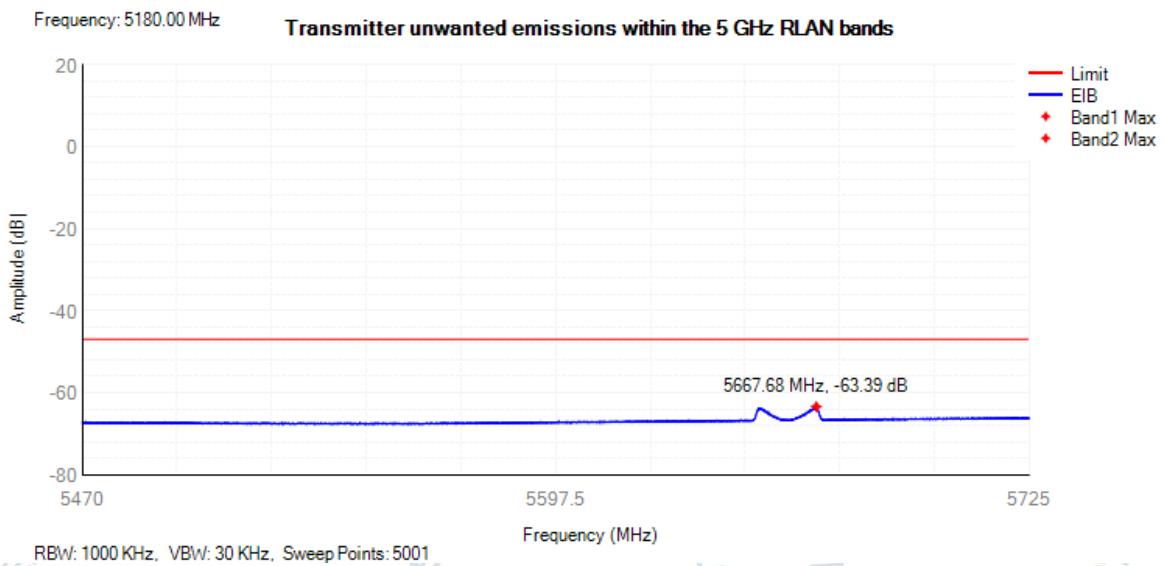



**Tx. Emissions EIB NVNT 802.11ac20 5180MHz Sub Band1**

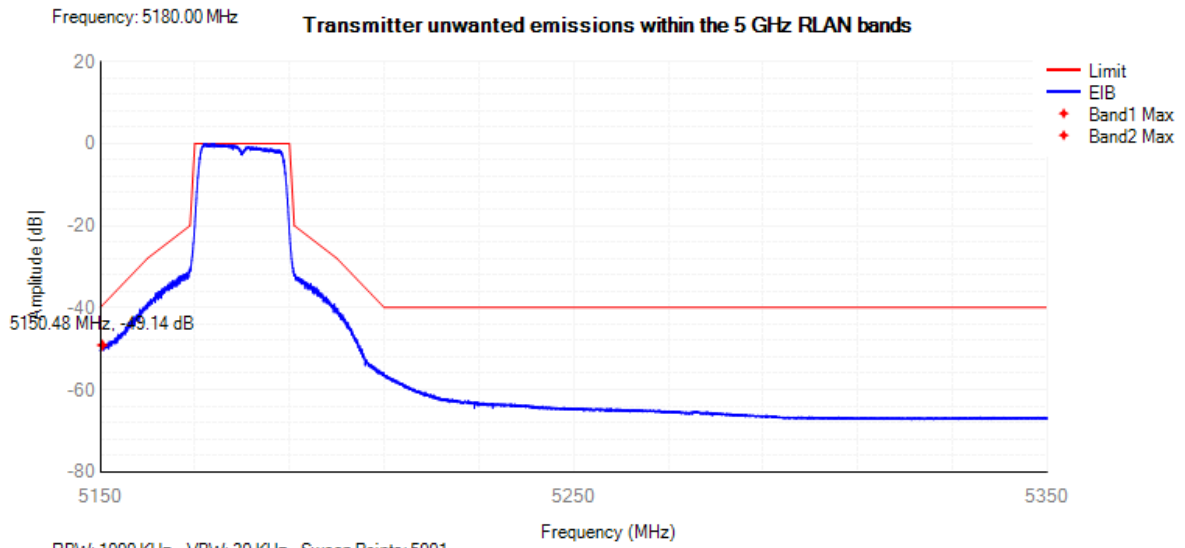

**Tx. Emissions EIB NVNT 802.11ac20 5180MHz Sub Band2**

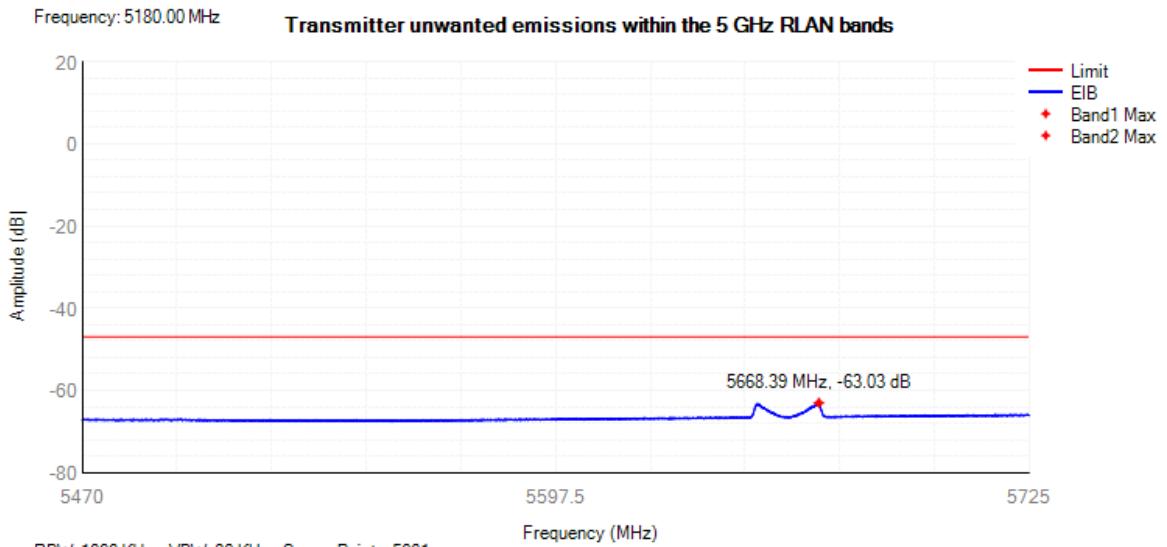

**Tx. Emissions EIB NVNT 802.11ac40 5190MHz Sub Band1**

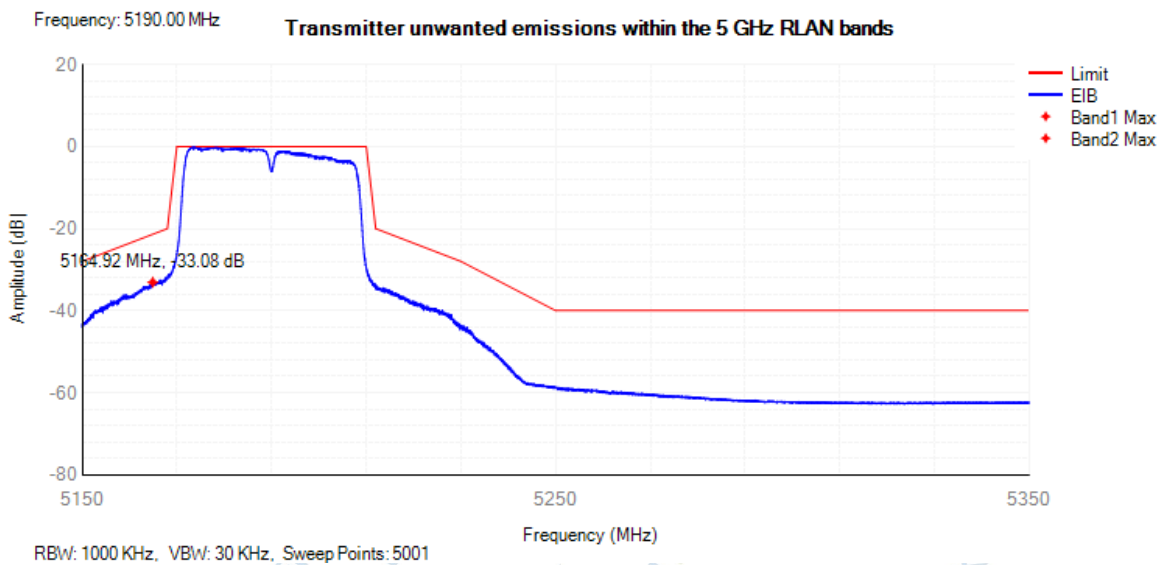

**Tx. Emissions EIB NVNT 802.11ac40 5190MHz Sub Band2**

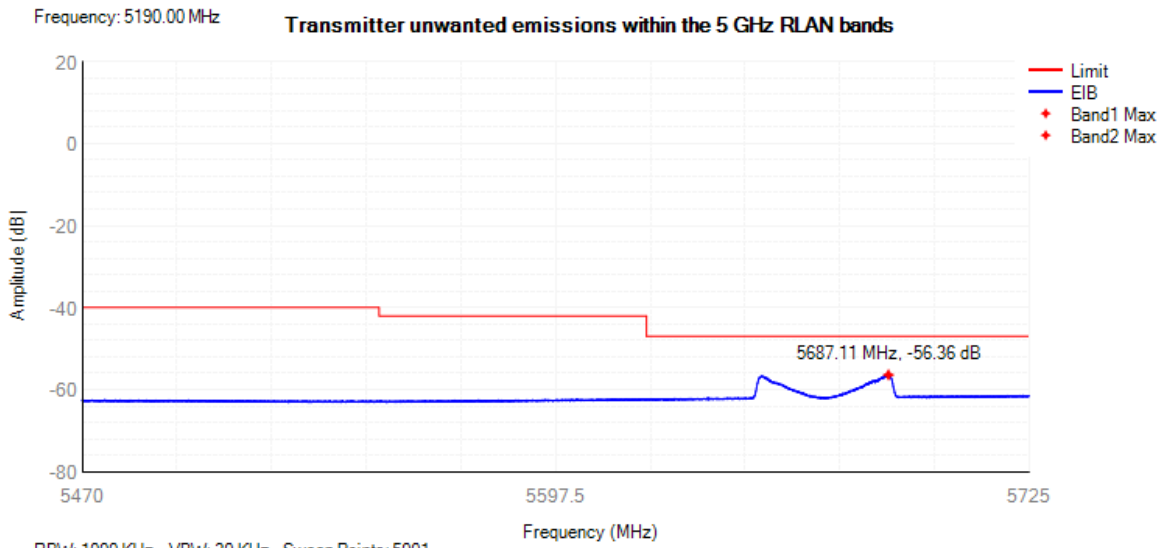

RBW: 1000 KHz, VBW: 30 KHz, Sweep Points: 5001

**Tx. Emissions EIB NVNT 802.11ac80 5210MHz Sub Band1**

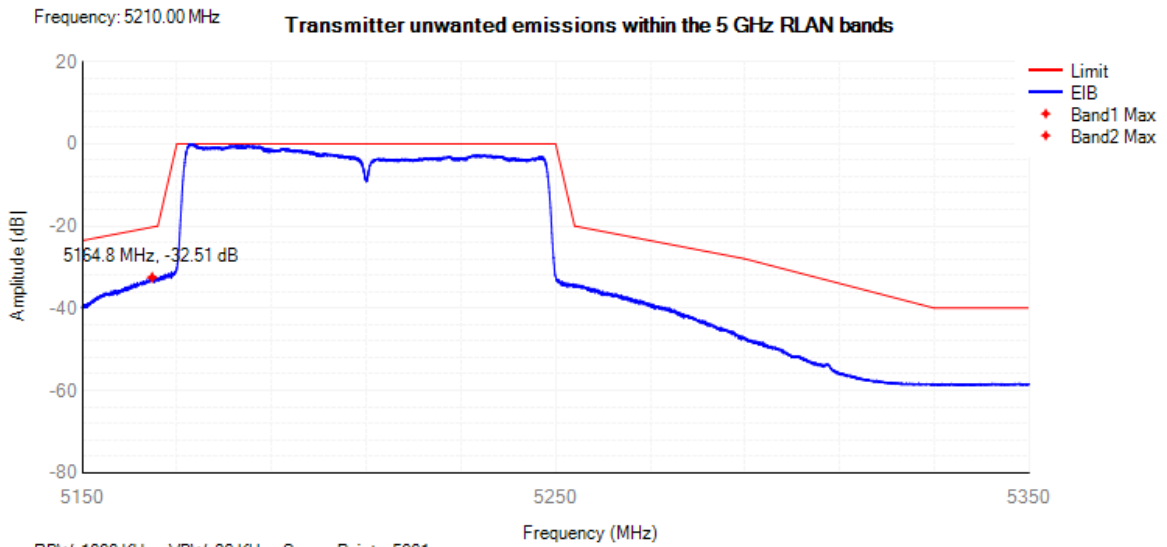

RBW: 1000 KHz, VBW: 30 KHz, Sweep Points: 5001

**Tx. Emissions EIB NVNT 802.11ac80 5210MHz Sub Band2**

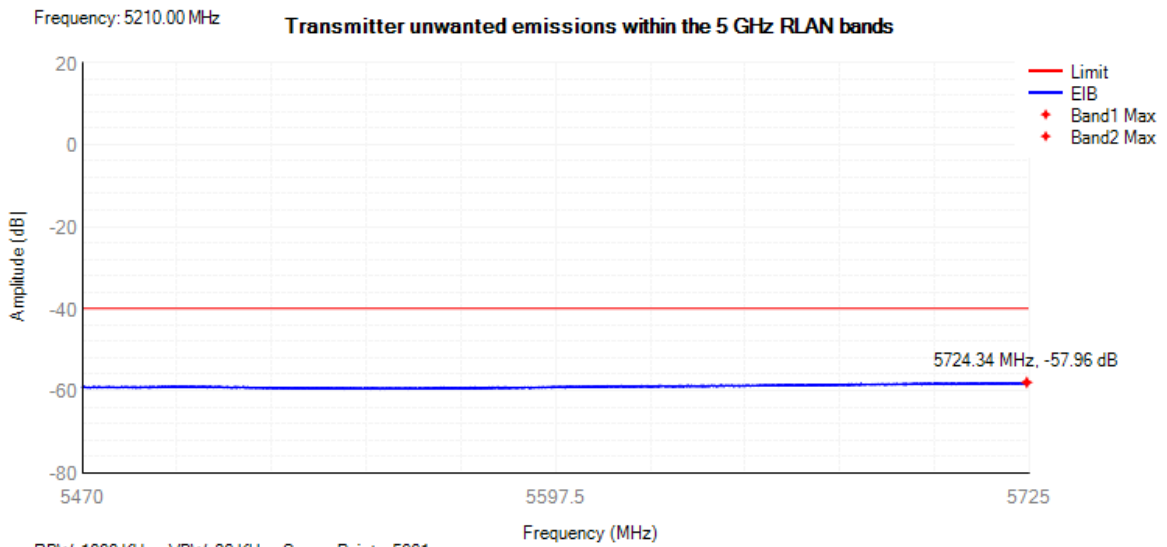

RBW: 1000 KHz, VBW: 30 KHz, Sweep Points: 5001

**Tx. Emissions EIB NVNT 802.11n(HT20) 5180MHz Sub Band1**

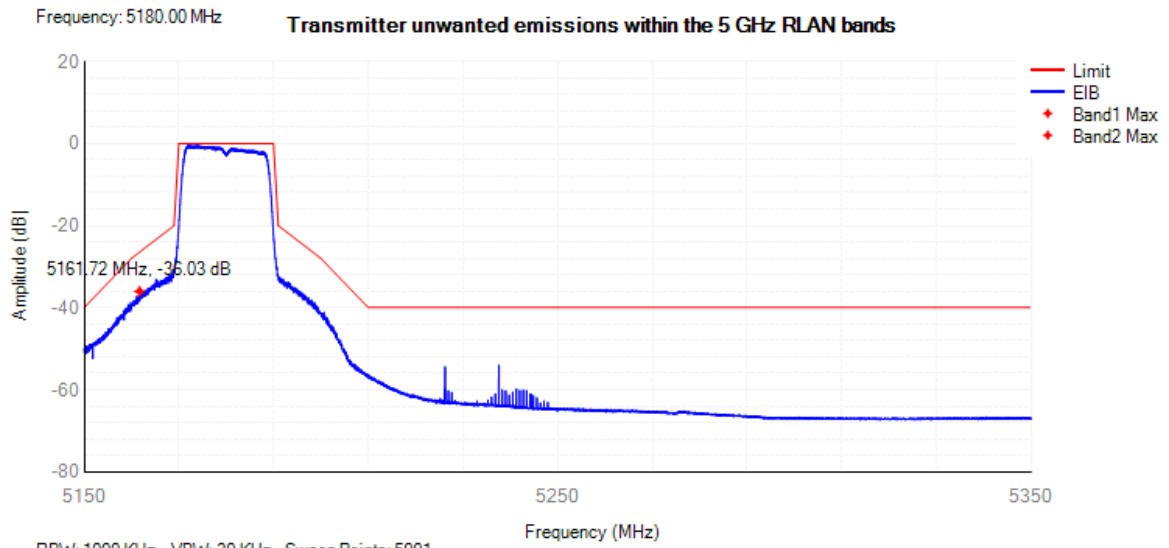

**Tx. Emissions EIB NVNT 802.11n(HT20) 5180MHz Sub Band2**

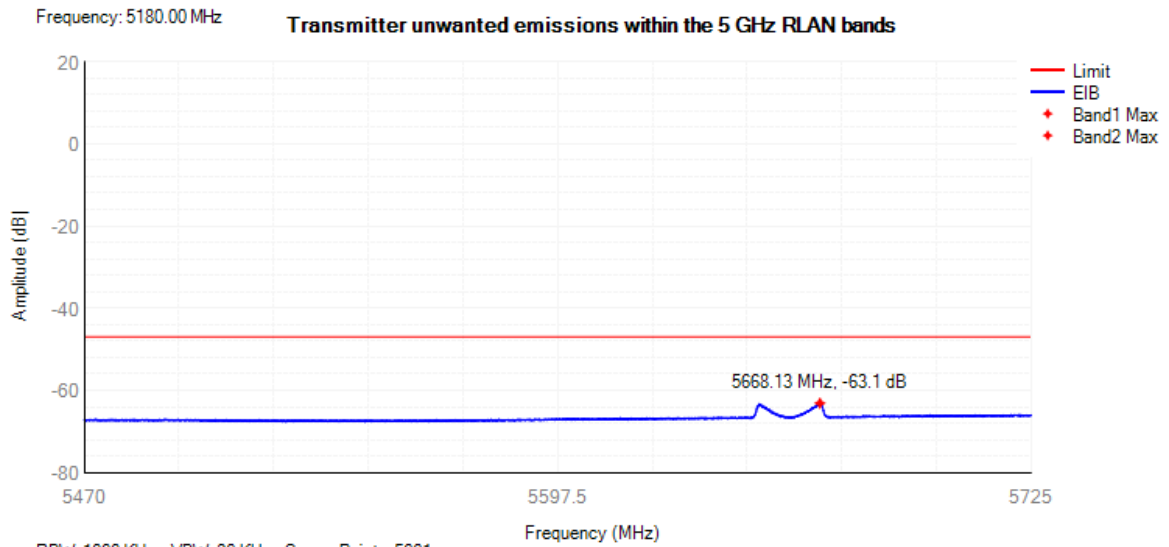

**Tx. Emissions EIB NVNT 802.11n(HT40) 5190MHz Sub Band1**

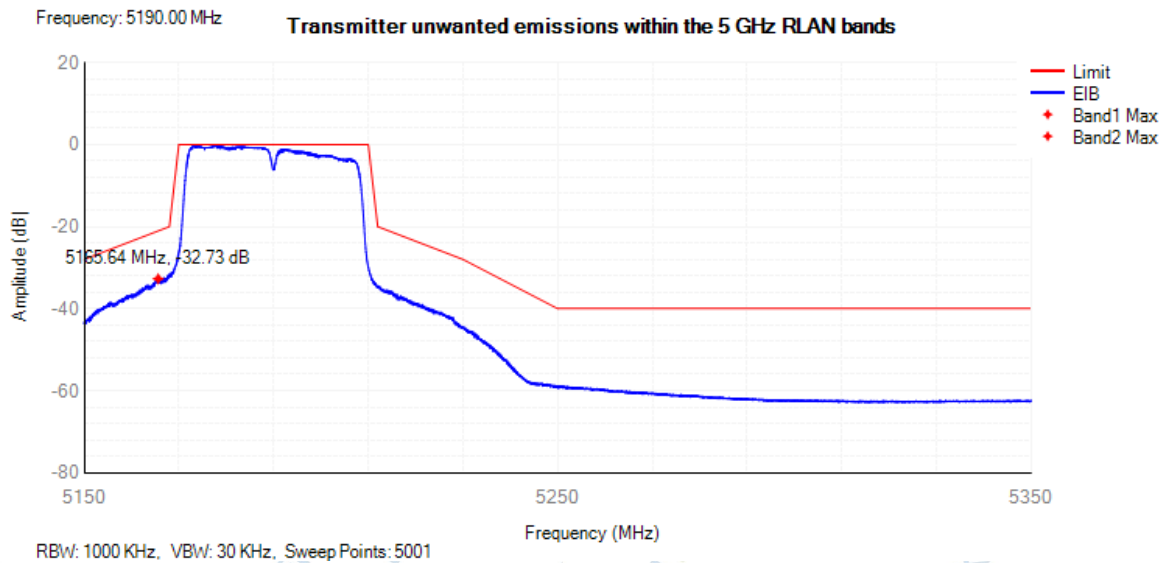



Tx. Emissions EIB NVNT 802.11n(HT40) 5190MHz Sub Band2

Frequency: 5190.00 MHz

Transmitter unwanted emissions within the 5 GHz RLAN bands

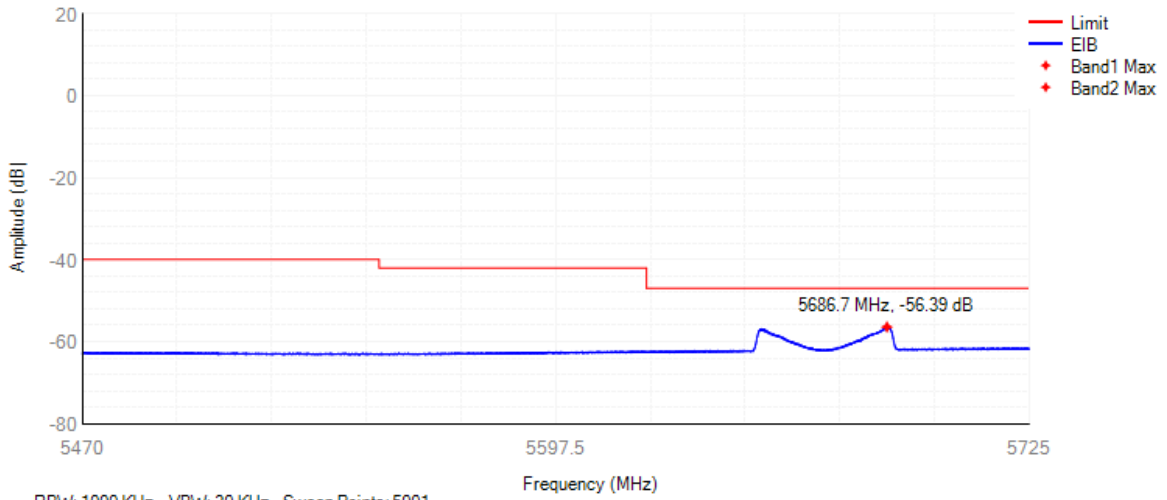

RBW: 1000 KHz, VBW: 30 KHz, Sweep Points: 5001

13.6 RECEIVER SPURIOUS EMISSIONS

Condition	Mode	Frequency (MHz)	Range	Spur Freq (MHz)	Spur Level Peak(dBm)	Spur Level RMS(dBm)	Limit (dBm)	Verdict
NVNT	802.11a	5180	30 MHz -1000 MHz	873.8	-83.44	NA	-57	Pass
NVNT	802.11a	5180	1000 MHz -26000 MHz	2469	-55.15	NA	-47	Pass
NVNT	802.11ac20	5180	30 MHz -1000 MHz	947.9	-84.13	NA	-57	Pass
NVNT	802.11ac20	5180	1000 MHz -26000 MHz	16730	-64.57	NA	-47	Pass
NVNT	802.11ac40	5190	30 MHz -1000 MHz	887.8	-83.93	NA	-57	Pass
NVNT	802.11ac40	5190	1000 MHz -26000 MHz	16747	-64.65	NA	-47	Pass
NVNT	802.11ac80	5210	30 MHz -1000 MHz	972.4	-83.62	NA	-57	Pass
NVNT	802.11ac80	5210	1000 MHz -26000 MHz	19417	-63.79	NA	-47	Pass
NVNT	802.11n(HT20)	5180	30 MHz -1000 MHz	995.2	-83.86	NA	-57	Pass
NVNT	802.11n(HT20)	5180	1000 MHz -26000 MHz	5174	-60.74	NA	-47	Pass
NVNT	802.11n(HT40)	5190	30 MHz -1000 MHz	910	-83.94	NA	-57	Pass
NVNT	802.11n(HT40)	5190	1000 MHz -26000 MHz	16274	-64.8	NA	-47	Pass

Rx. Spurious NVNT 802.11a 5180MHz

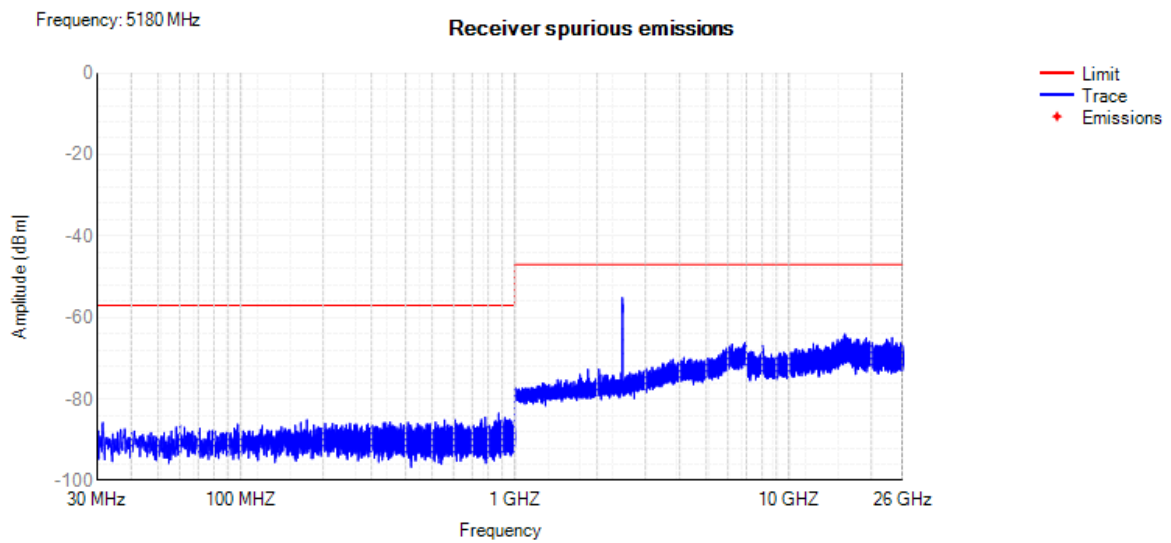

Rx. Spurious NVNT 802.11ac20 5180MHz

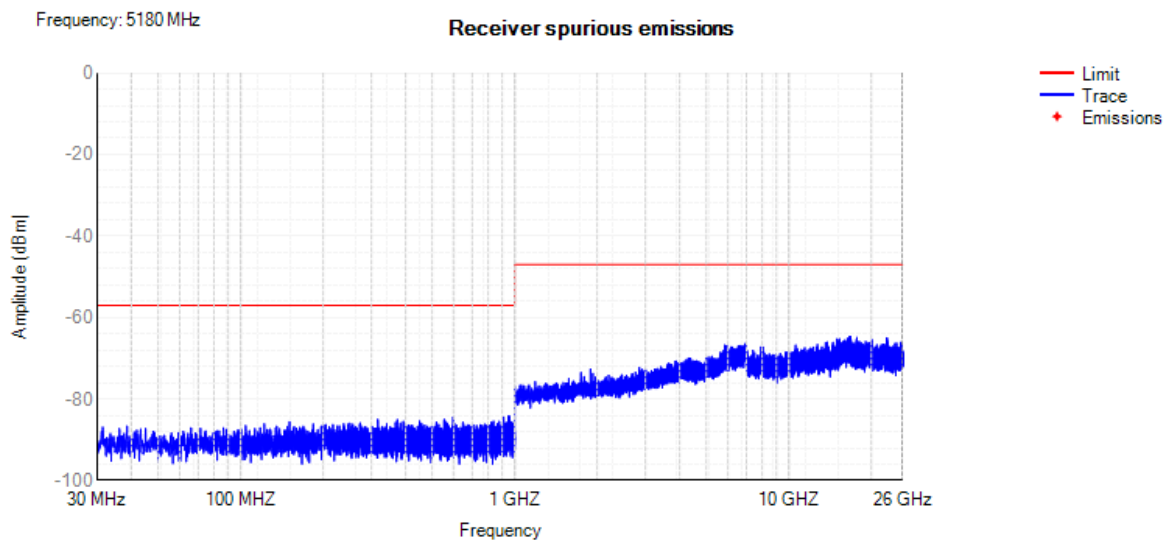

Rx. Spurious NVNT 802.11ac40 5190MHz

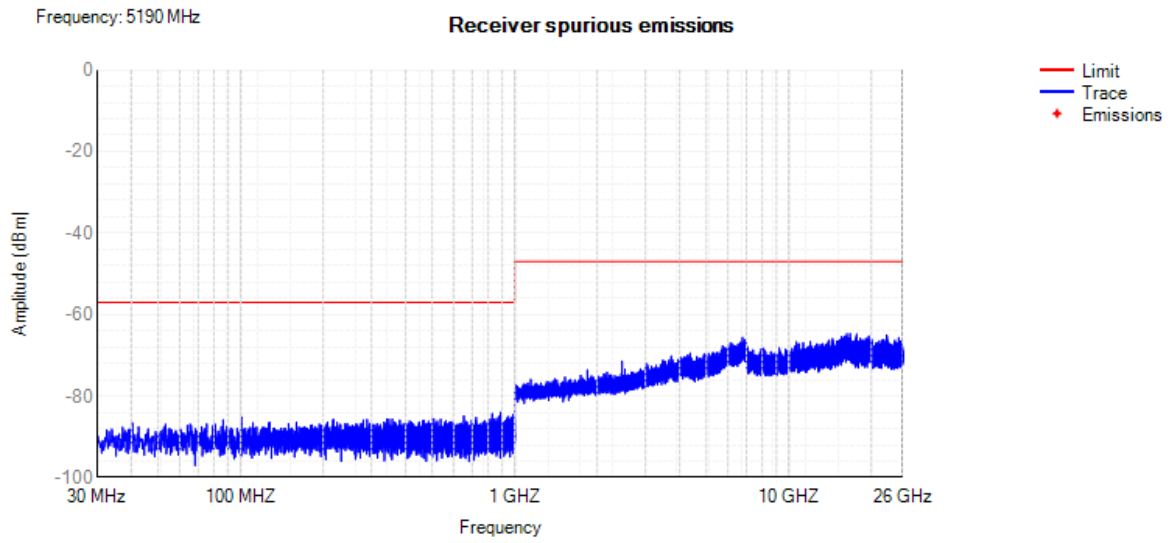

Rx. Spurious NVNT 802.11ac80 5210MHz

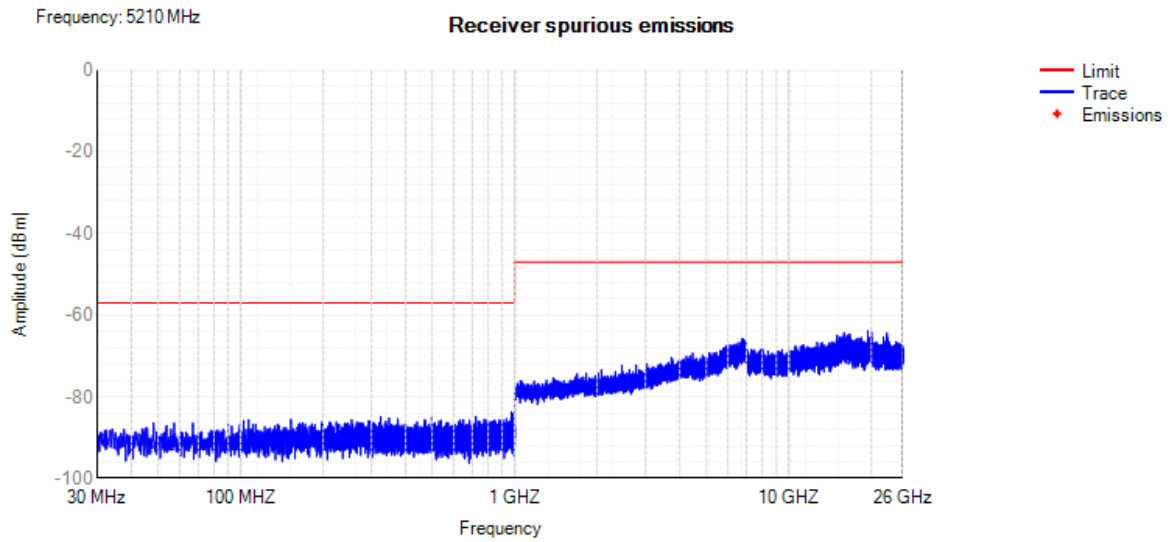

Rx. Spurious NVNT 802.11n(HT20) 5180MHz

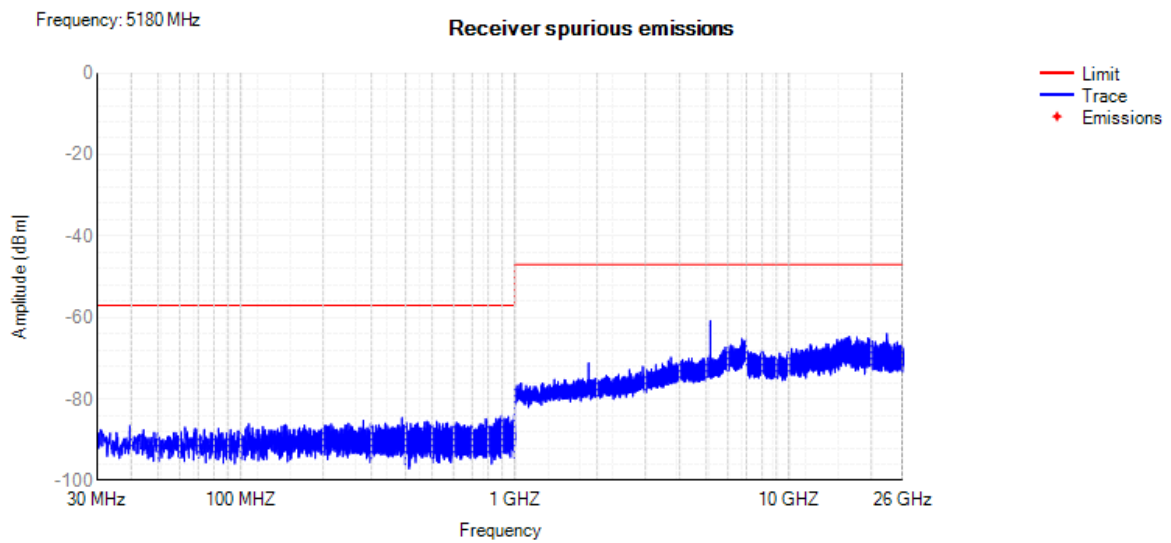



Rx. Spurious NVNT 802.11n(HT40) 5190MHz

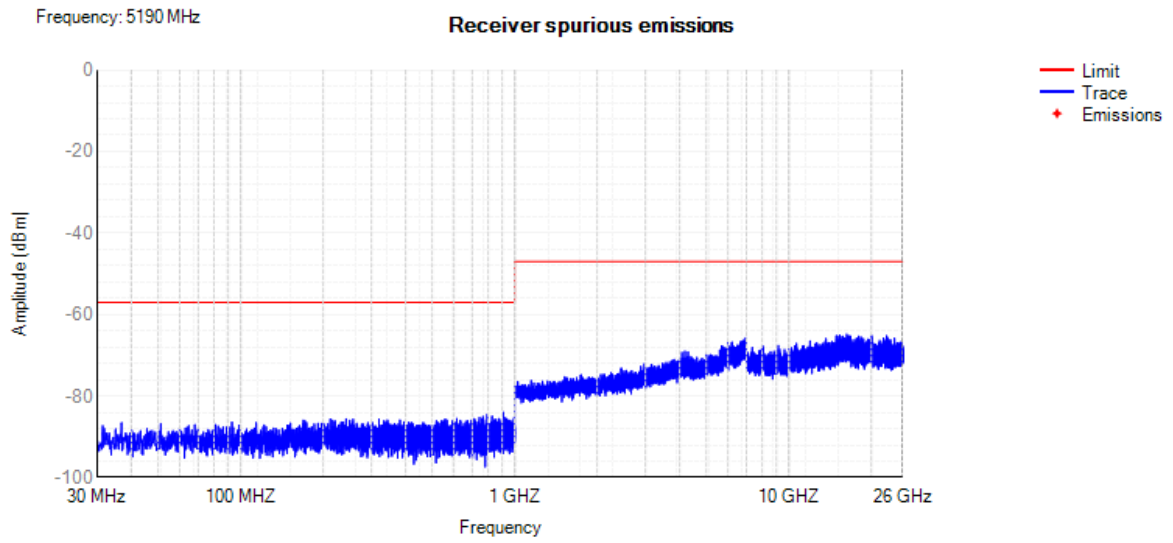

13.7 ADAPTIVITY

Condition	Mode	Frequency (MHz)	Interfer Type	Interfer Level (dBm/MHz)	Short Control (ms)	Limit (ms)	Short Control (n)	Limit (n)	Verdict
NVNT	802.11a	5180	AWGN	-75	1.87	<=2.5	4	<=50	Pass
NVNT	802.11a	5180	LTE	-75	0	<=2.5	0	<=50	Pass
NVNT	802.11a	5180	OFDM	-75	0.93	<=2.5	2	<=50	Pass
NVNT	802.11ac80	5210	AWGN	-75	0	<=2.5	0	<=50	Pass
NVNT	802.11ac80	5210	LTE	-75	0	<=2.5	0	<=50	Pass
NVNT	802.11ac80	5210	OFDM	-75	0.47	<=2.5	1	<=50	Pass
NVNT	802.11n(HT40)	5190	AWGN	-75	0	<=2.5	0	<=50	Pass
NVNT	802.11n(HT40)	5190	LTE	-75	0	<=2.5	0	<=50	Pass

Adaptivity NVNT 802.11a 5180MHz AWGN

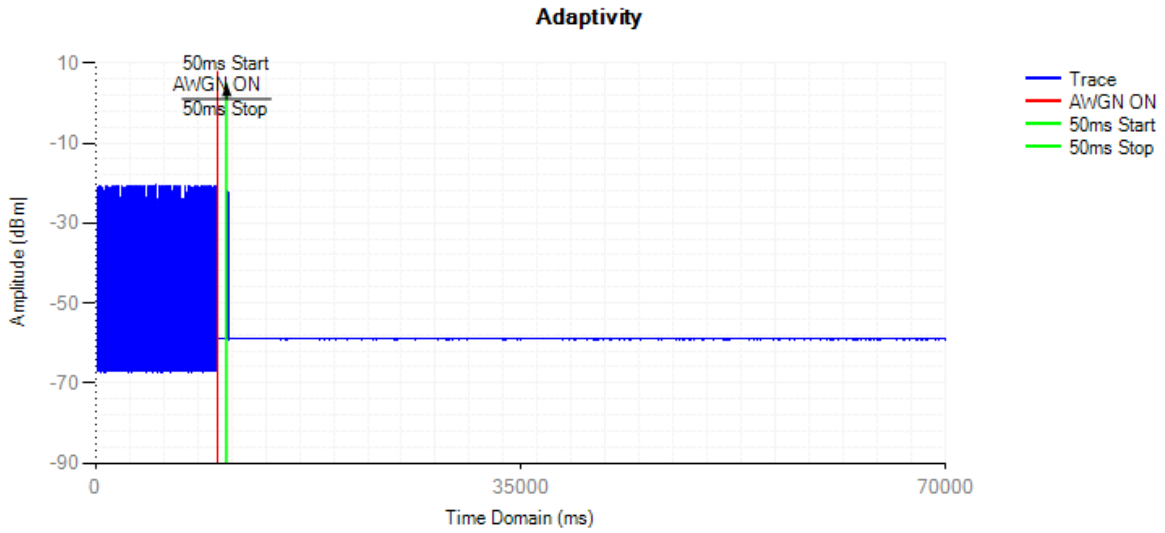

Control Signal NVNT 802.11a 5180MHz AWGN

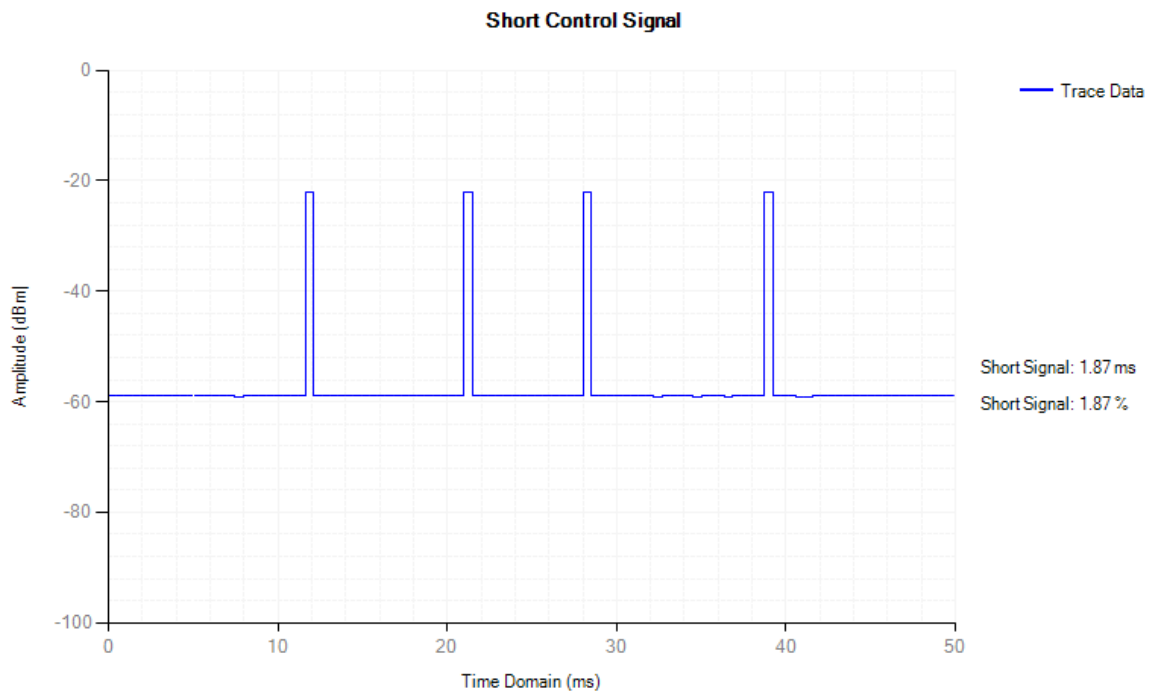

### Adaptivity NVNT 802.11a 5180MHz LTE

Adaptivity

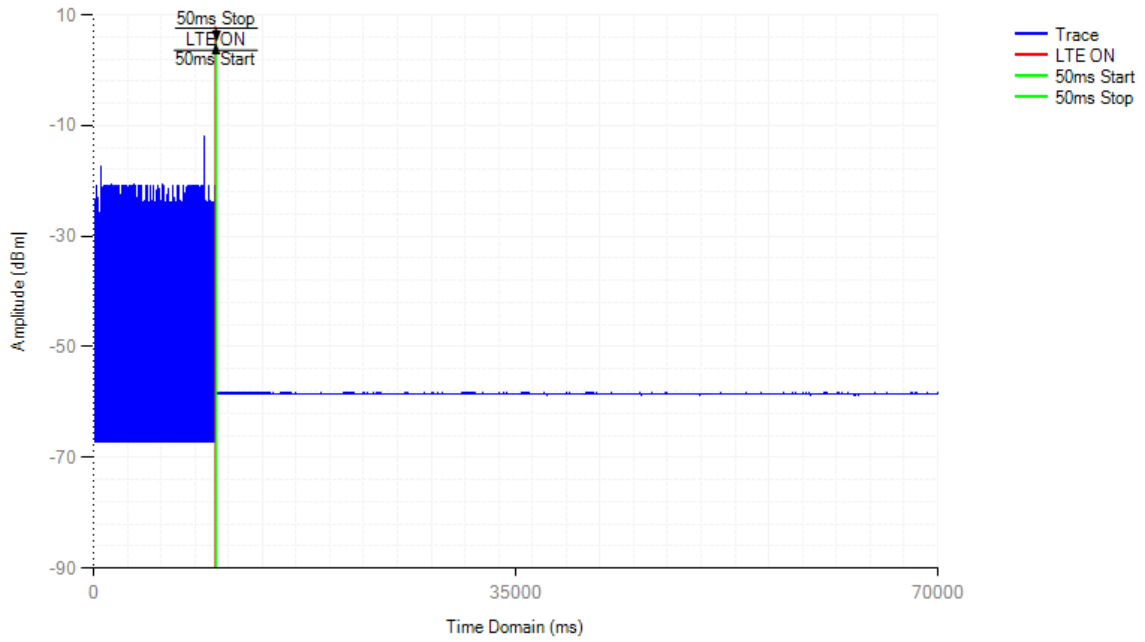

### Control Signal NVNT 802.11a 5180MHz LTE

Short Control Signal

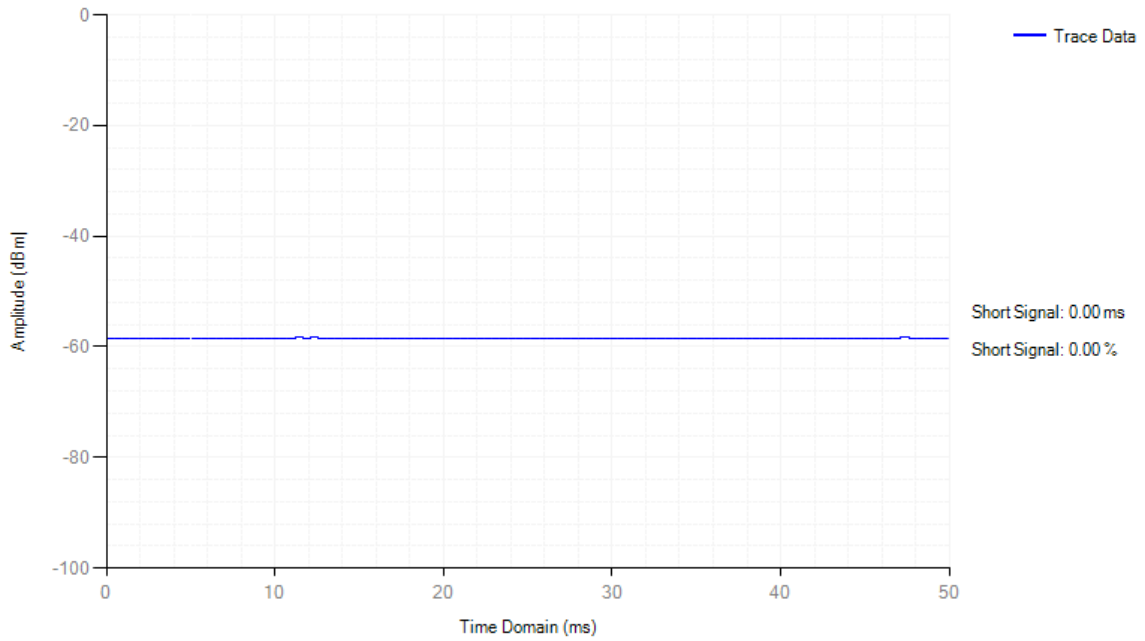



### Adaptivity NVNT 802.11a 5180MHz OFDM

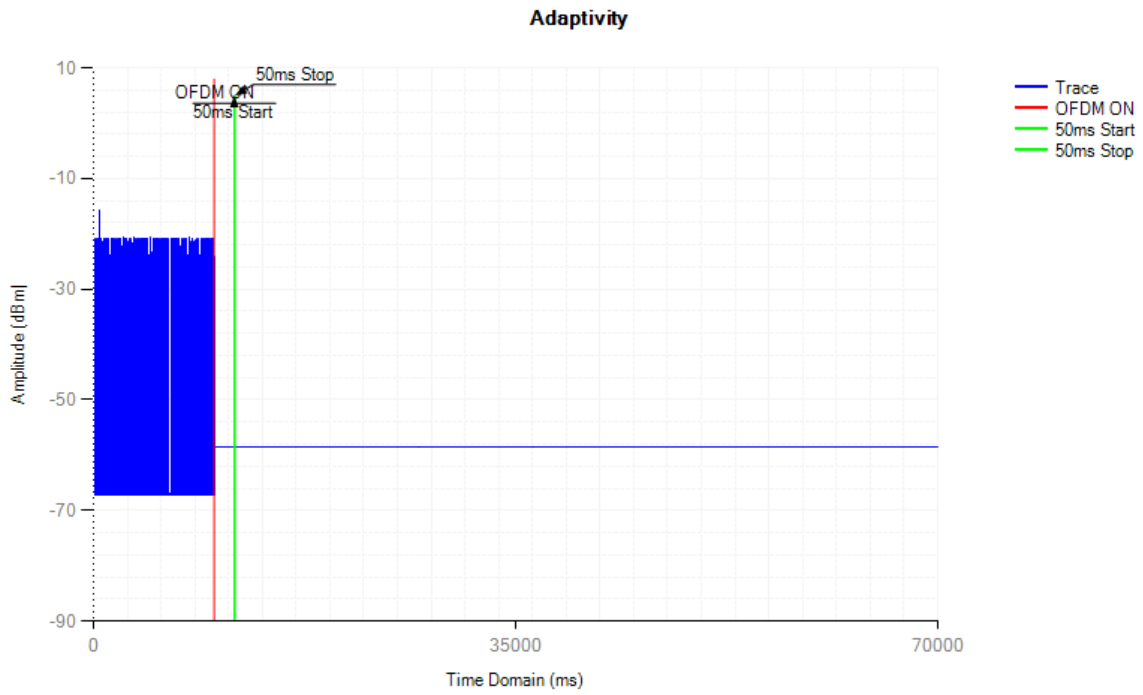

### Control Signal NVNT 802.11a 5180MHz OFDM

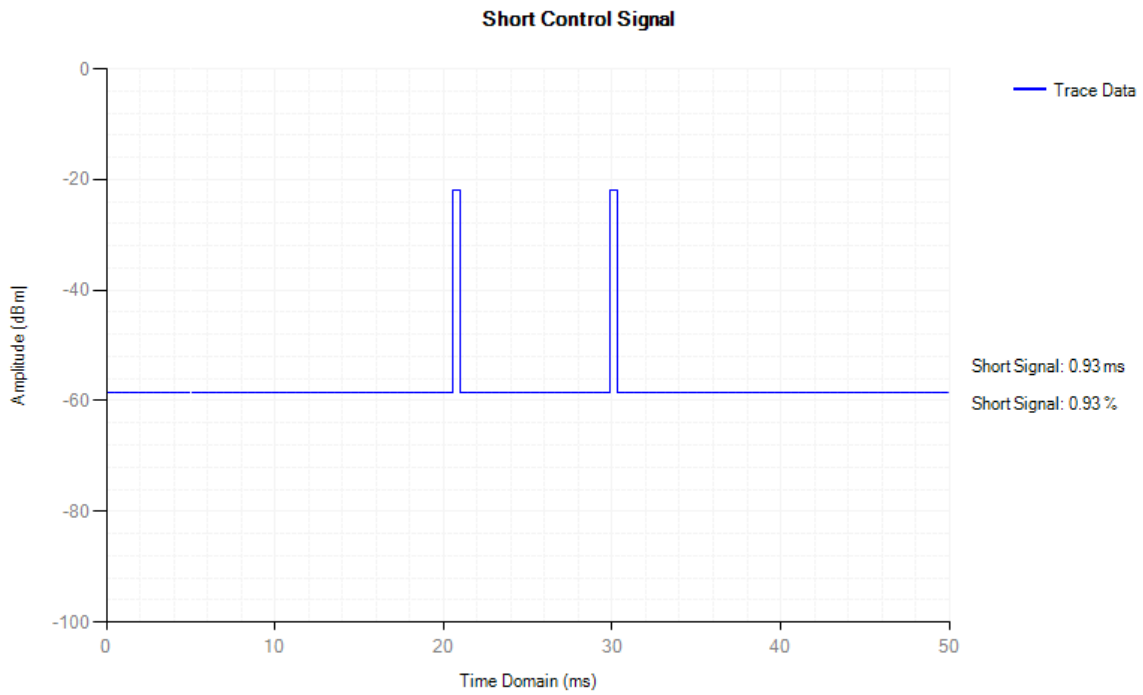

Adaptivity NVNT 802.11ac80 5210MHz AWGN

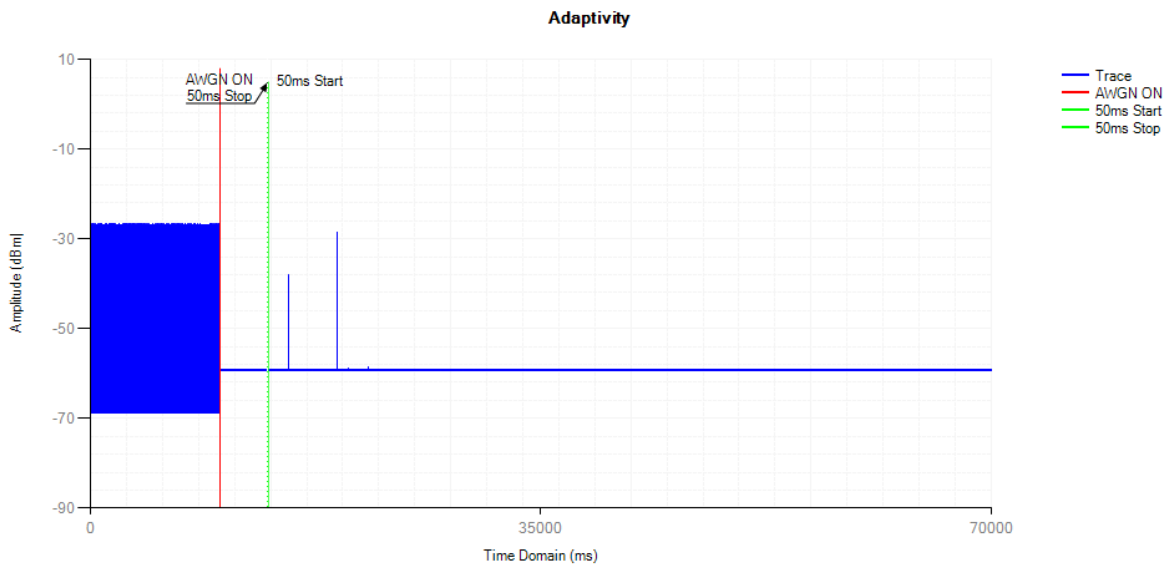

Control Signal NVNT 802.11ac80 5210MHz AWGN

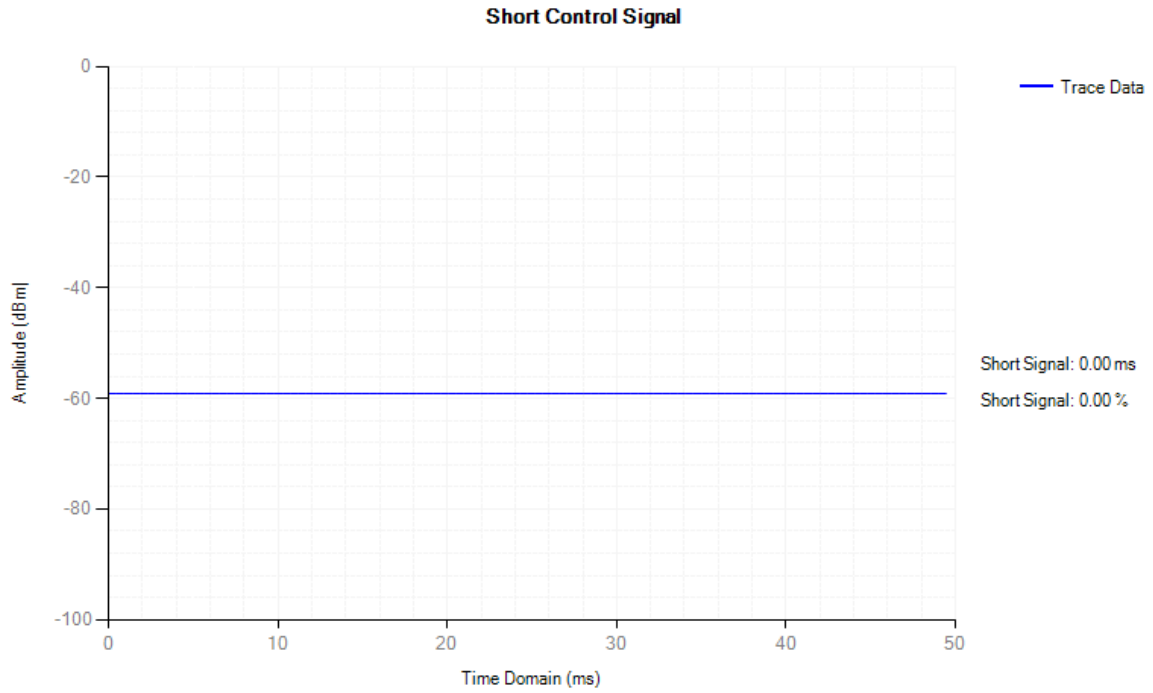

### Adaptivity NVNT 802.11ac80 5210MHz LTE

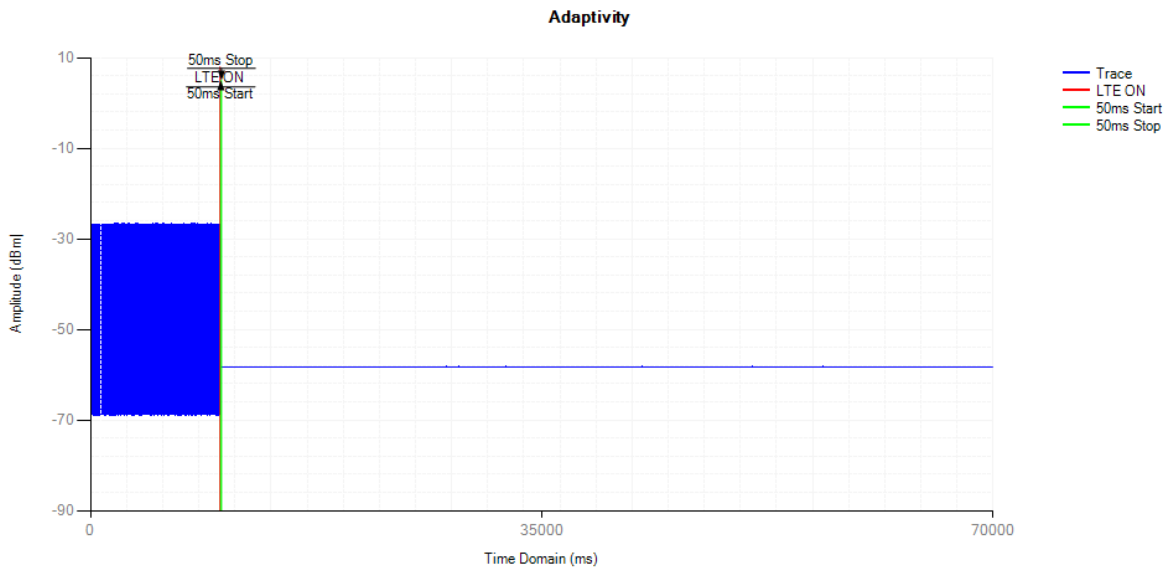

### Control Signal NVNT 802.11ac80 5210MHz LTE

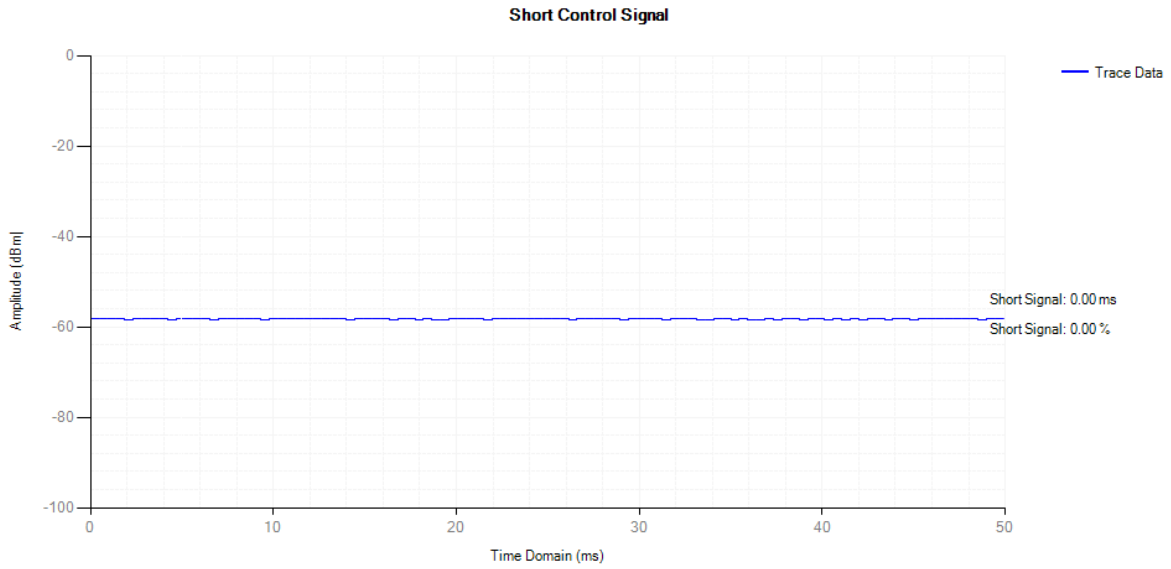

### Adaptivity NVNT 802.11ac80 5210MHz OFDM

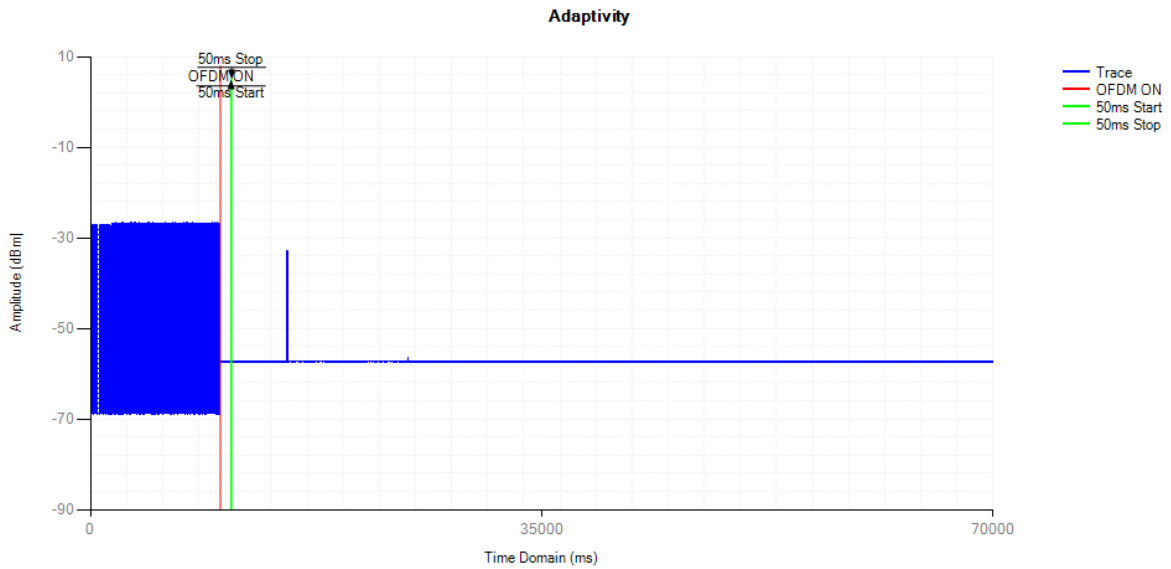



Control Signal NVNT 802.11ac80 5210MHz OFDM

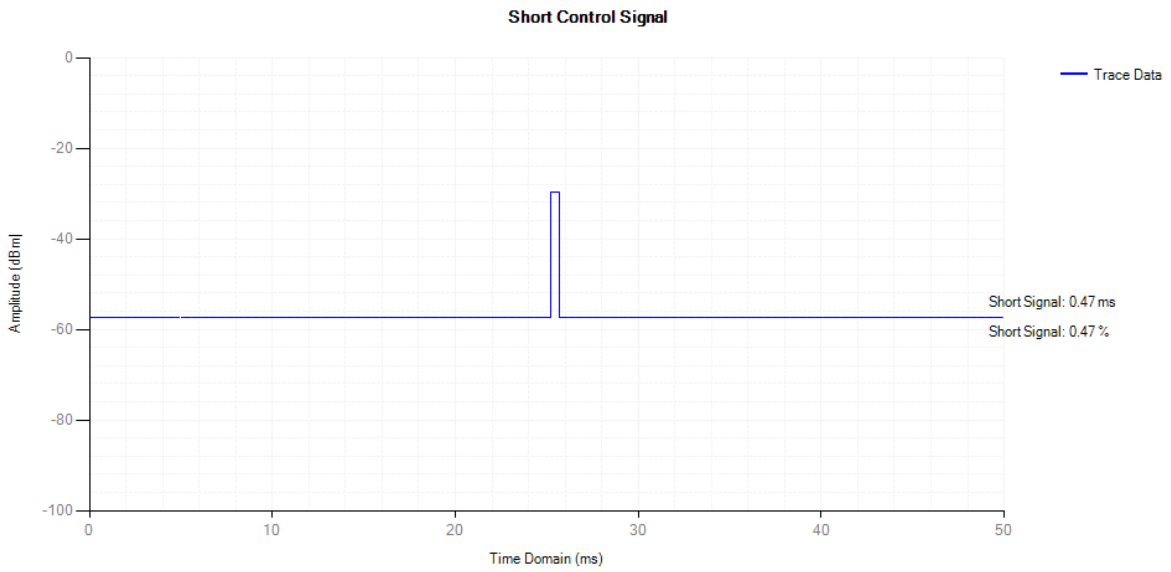

Adaptivity NVNT 802.11n(HT40) 5190MHz AWGN

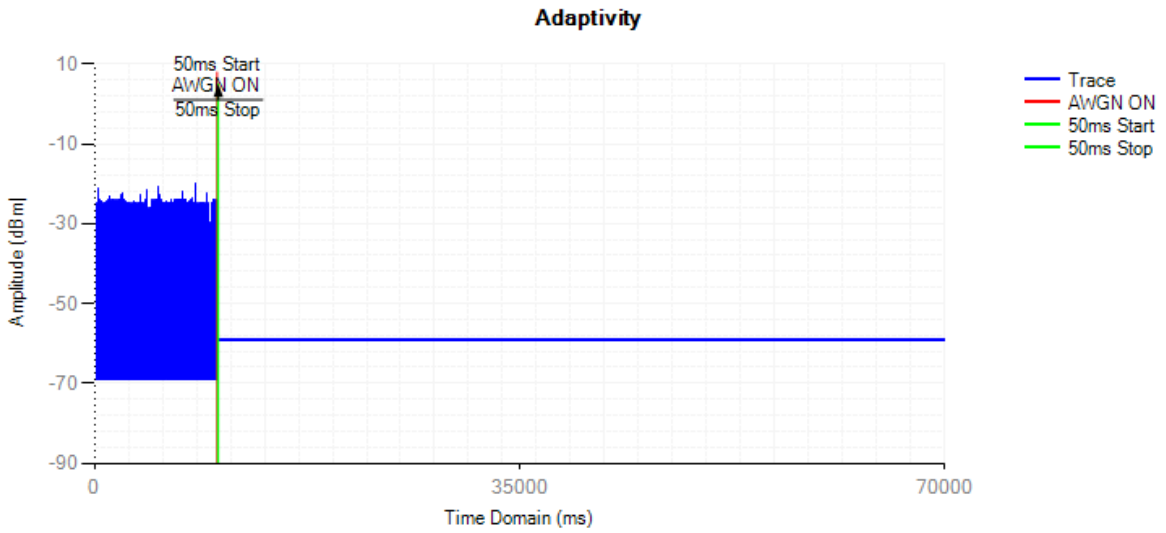

Control Signal NVNT 802.11n(HT40) 5190MHz AWGN

Short Control Signal

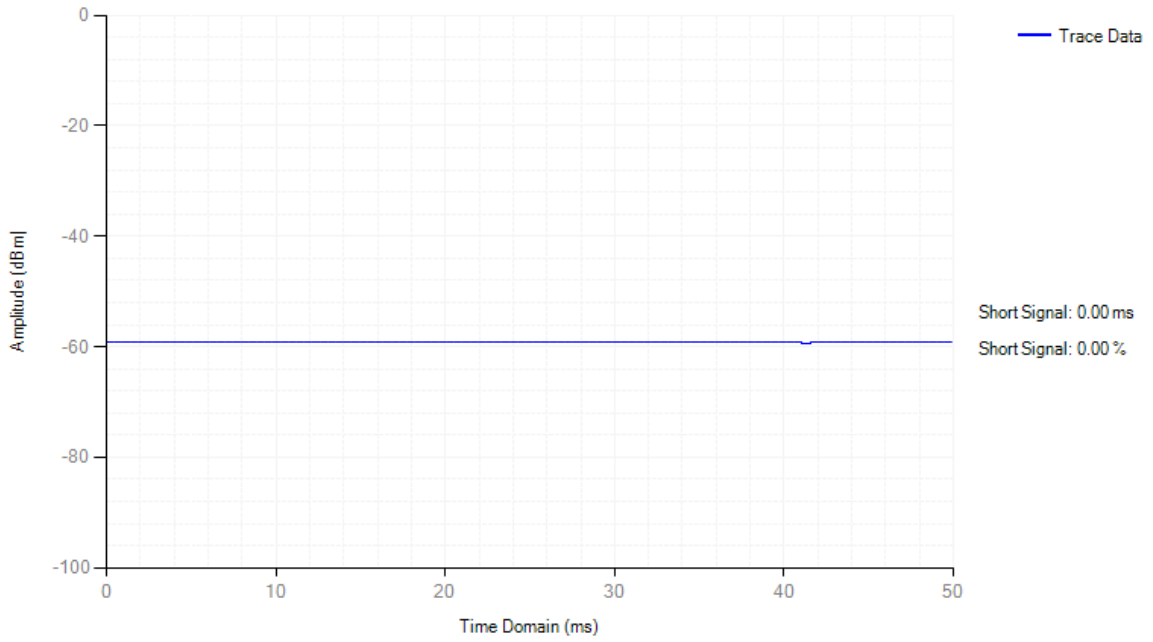

Adaptivity NVNT 802.11n(HT40) 5190MHz LTE

Adaptivity

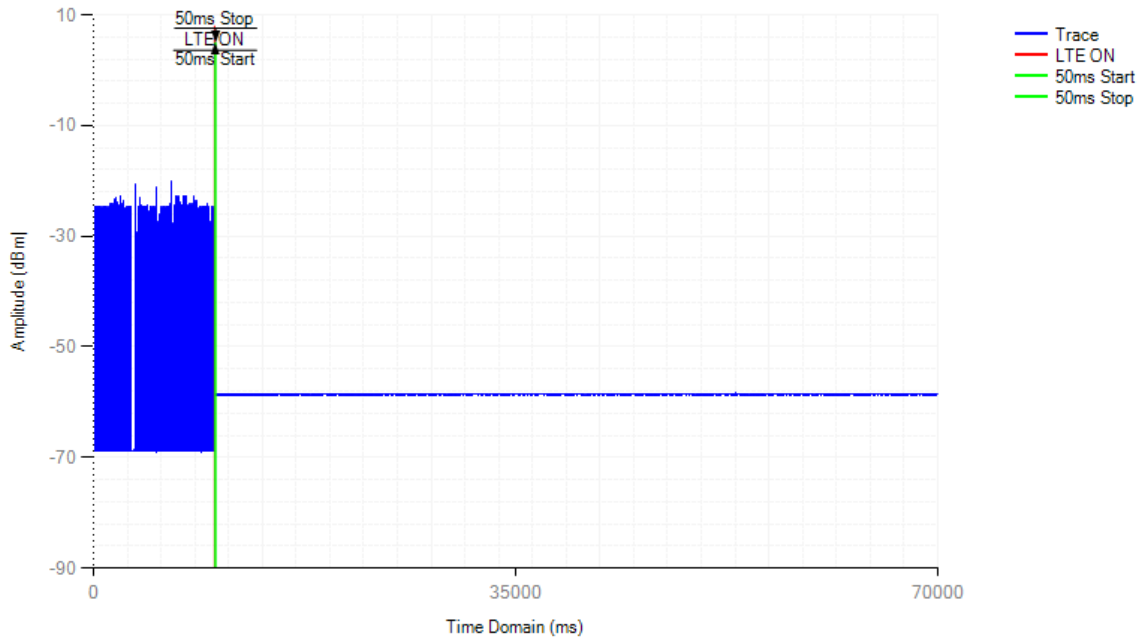

Control Signal NVNT 802.11n(HT40) 5190MHz LTE

Short Control Signal

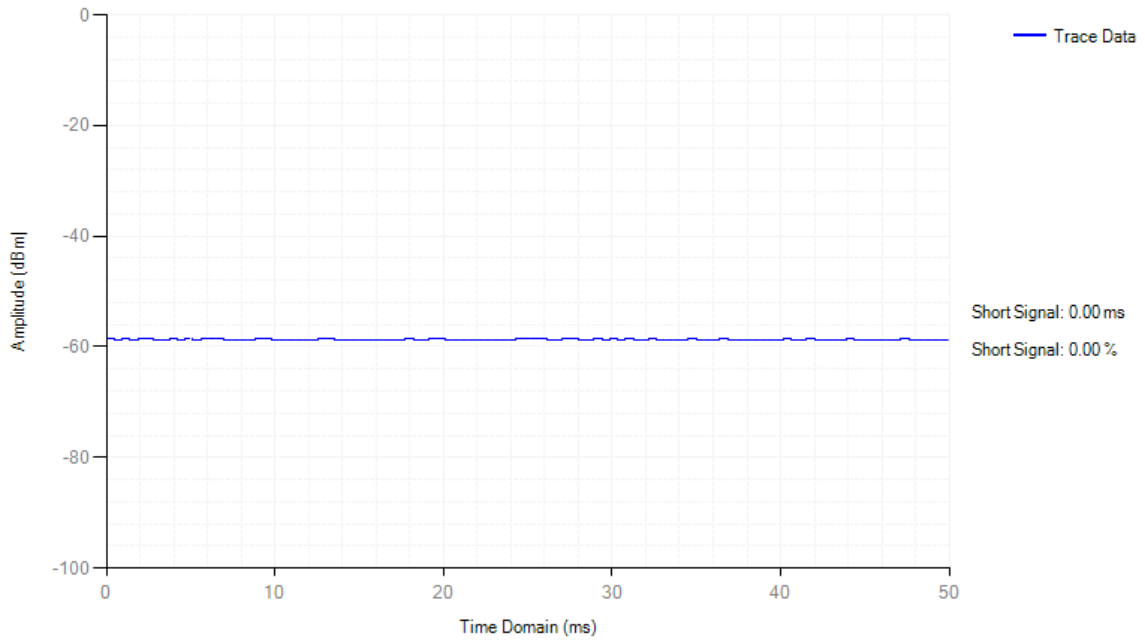

Adaptivity NVNT 802.11n(HT40) 5190MHz OFDM

Adaptivity

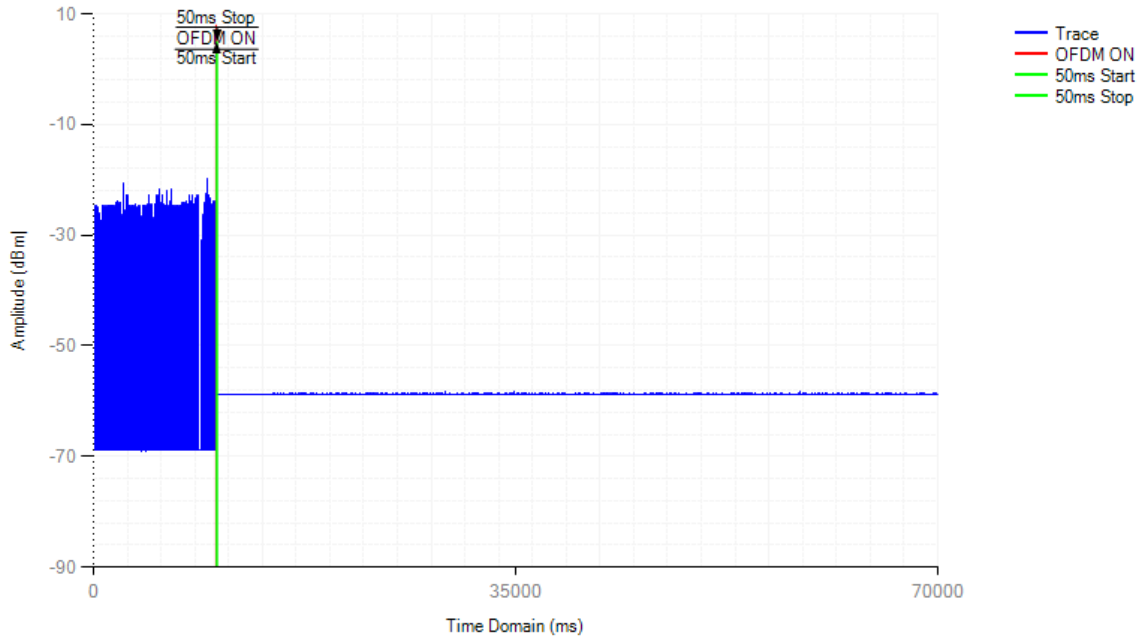



Control Signal NVNT 802.11n(HT40) 5190MHz OFDM

Short Control Signal

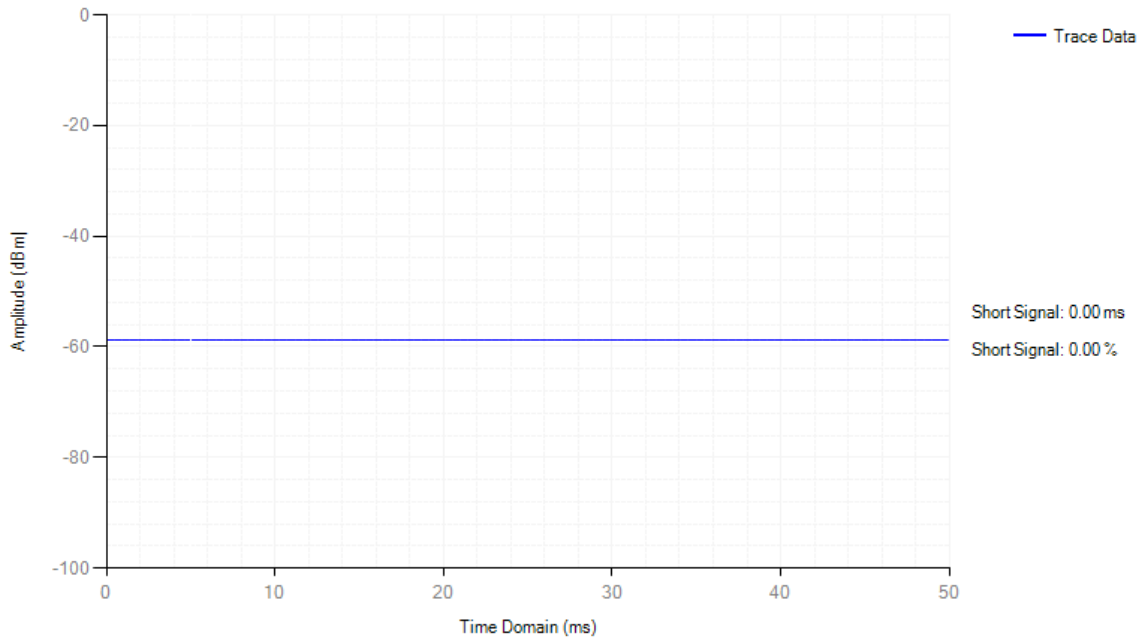

13.8 ADAPTIVITY COT CHANNEL OCCUPANCY TIME

Condition	Mode	Frequency (MHz)	Priority Class	Max COT (ms)	Limit COT (ms)	Min Idle Time (ms)	Limit Idle Time (ms)	Verdict
NVNT	802.11a	5180	1	0.838	<=6	0.043	>0.027	Pass
NVNT	802.11ac80	5210	1	2.89	<=6	0.082	>0.027	Pass
NVNT	802.11n(HT40)	5190	1	0.805	<=6	0.035	>0.027	Pass

COT NVNT 802.11a 5180MHz

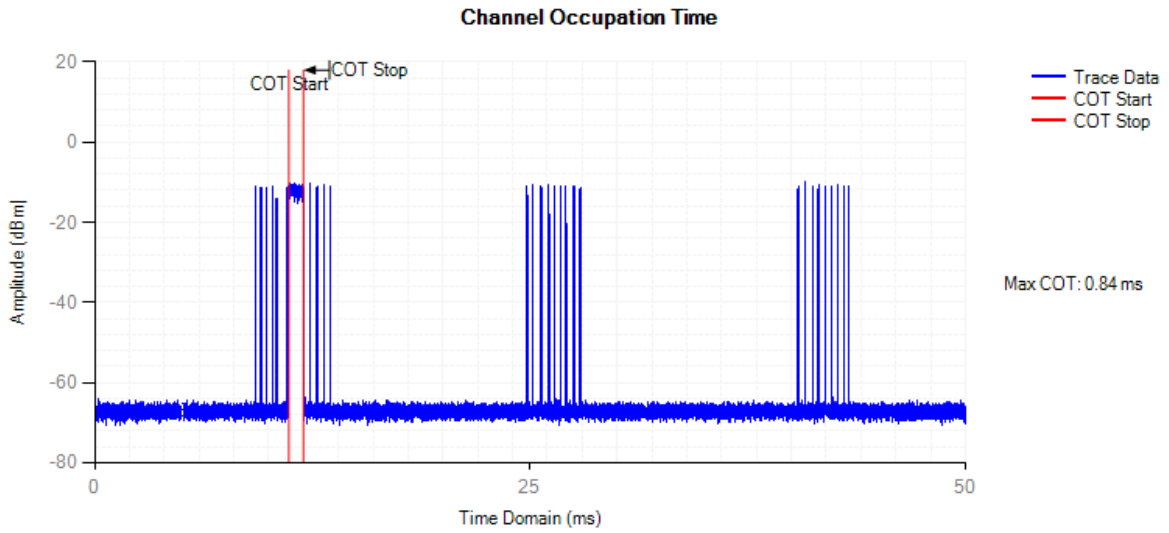

Idle NVNT 802.11a 5180MHz

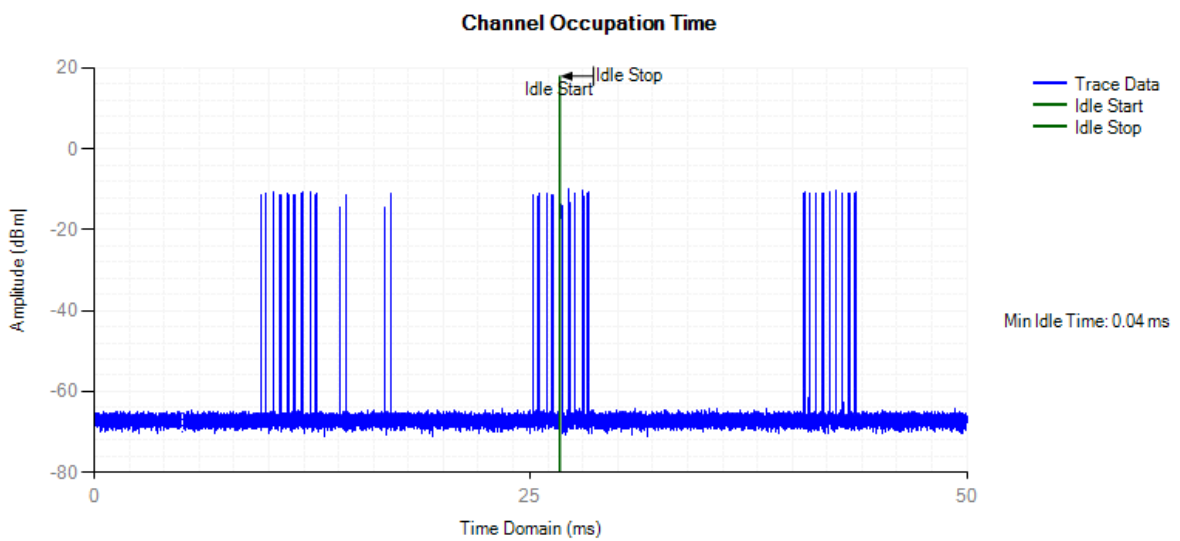

COT NVNT 802.11ac80 5210MHz

Channel Occupation Time

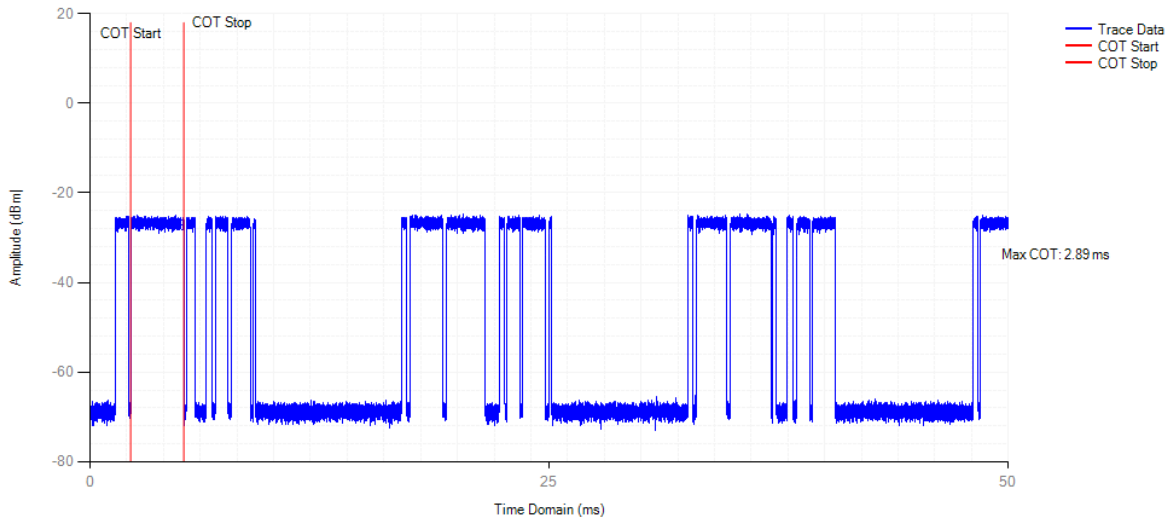

Idle NVNT 802.11ac80 5210MHz

Channel Occupation Time

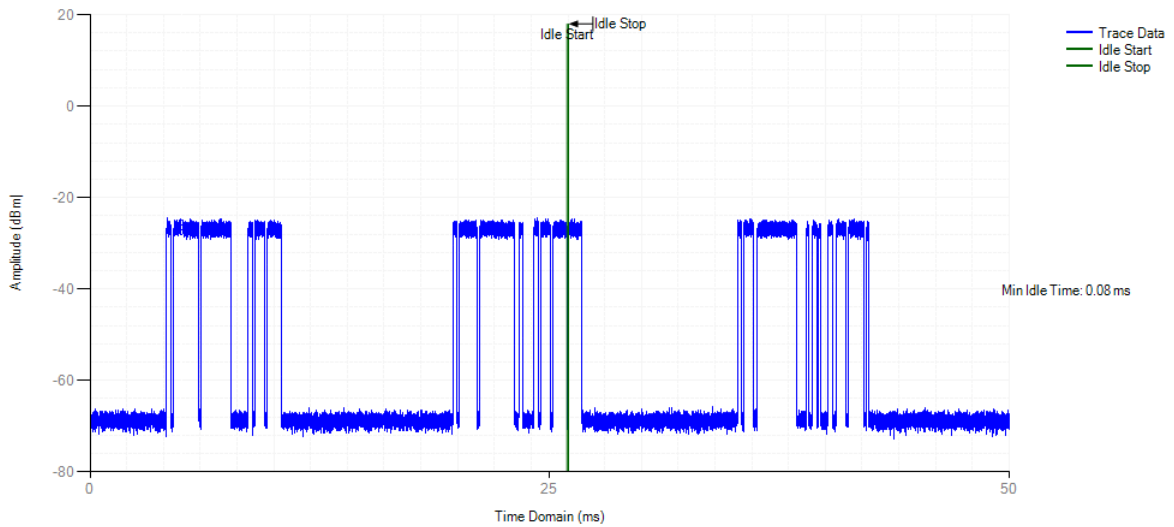

COT NVNT 802.11n(HT40) 5190MHz

Channel Occupation Time

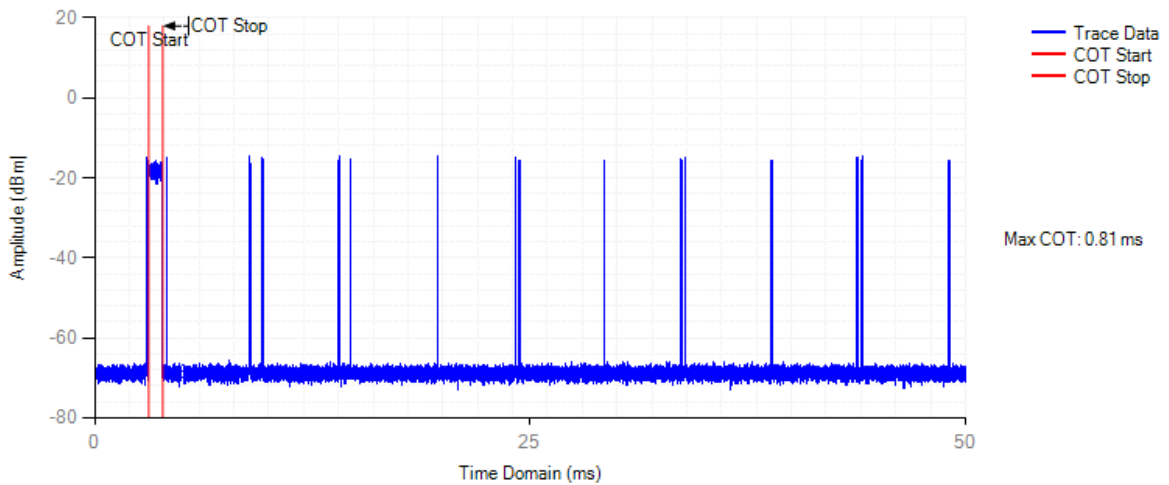



Idle NVNT 802.11n(HT40) 5190MHz

Channel Occupation Time

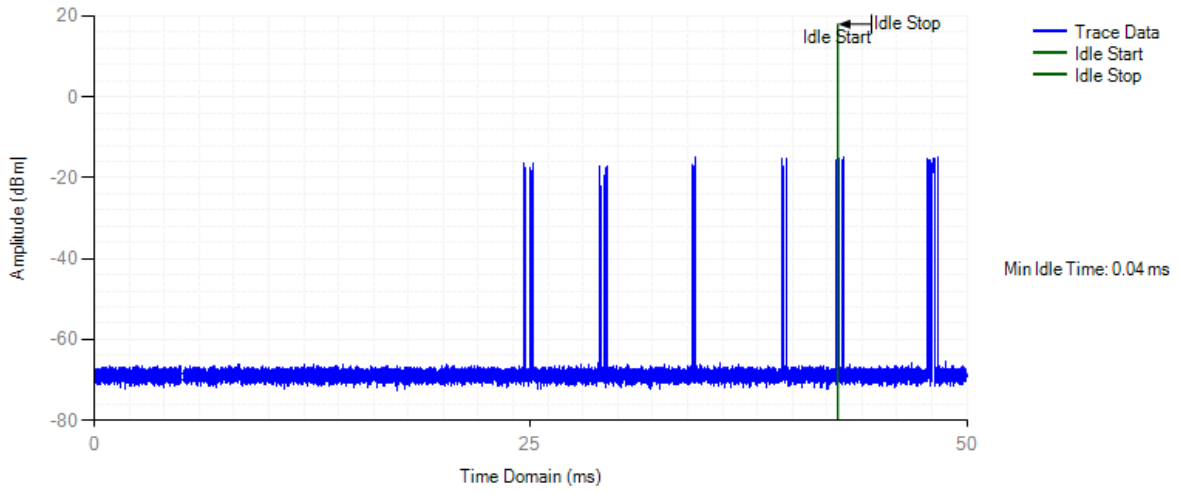

**13.9 ADAPTIVITY COT IDLE PERIOD PROBABILITY**

Condition	Mode	Frequency (MHz)	Priority Class	Bn	H(Bn)	Pn (%)	Limit (%)	Verdict
NVNT	802.11a	5180	1	0	371	3.7	5	Pass
NVNT	802.11a	5180	1	1	1	3.71	12	Pass
NVNT	802.11a	5180	1	2	3	3.74	18.25	Pass
NVNT	802.11a	5180	1	3	3	3.77	24.5	Pass
NVNT	802.11a	5180	1	4	0	3.77	30.75	Pass
NVNT	802.11a	5180	1	5	0	3.77	37	Pass
NVNT	802.11a	5180	1	6	3	3.8	43.25	Pass
NVNT	802.11a	5180	1	7	0	3.8	49.5	Pass
NVNT	802.11a	5180	1	8	0	3.8	55.75	Pass
NVNT	802.11a	5180	1	9	0	3.8	62	Pass
NVNT	802.11a	5180	1	10	0	3.8	68.25	Pass
NVNT	802.11a	5180	1	11	1	3.81	74.5	Pass
NVNT	802.11a	5180	1	12	0	3.81	80.75	Pass
NVNT	802.11a	5180	1	13	0	3.81	87	Pass
NVNT	802.11a	5180	1	14	1	3.82	93.25	Pass
NVNT	802.11a	5180	1	15	1	3.83	99.5	Pass
NVNT	802.11a	5180	1	16	9640	100	100	Pass
NVNT	802.11ac80	5210	1	0	4	3.33	5	Pass
NVNT	802.11ac80	5210	1	1	1	4.17	12	Pass
NVNT	802.11ac80	5210	1	2	1	5	18.25	Pass
NVNT	802.11ac80	5210	1	3	16	18.33	24.5	Pass
NVNT	802.11ac80	5210	1	4	7	24.17	30.75	Pass
NVNT	802.11ac80	5210	1	5	10	32.5	37	Pass
NVNT	802.11ac80	5210	1	6	4	35.83	43.25	Pass
NVNT	802.11ac80	5210	1	7	6	40.83	49.5	Pass
NVNT	802.11ac80	5210	1	8	2	42.5	55.75	Pass
NVNT	802.11ac80	5210	1	9	4	45.83	62	Pass
NVNT	802.11ac80	5210	1	10	2	47.5	68.25	Pass
NVNT	802.11ac80	5210	1	11	1	48.33	74.5	Pass
NVNT	802.11ac80	5210	1	12	8	55	80.75	Pass
NVNT	802.11ac80	5210	1	13	3	57.5	87	Pass
NVNT	802.11ac80	5210	1	14	6	62.5	93.25	Pass
NVNT	802.11ac80	5210	1	15	6	67.5	99.5	Pass
NVNT	802.11ac80	5210	1	16	39	100	100	Pass
NVNT	802.11n(HT40)	5190	1	0	511	4.11	5	Pass
NVNT	802.11n(HT40)	5190	1	1	3	5.14	12	Pass
NVNT	802.11n(HT40)	5190	1	2	171	6.85	18.25	Pass
NVNT	802.11n(HT40)	5190	1	3	181	8.65	24.5	Pass
NVNT	802.11n(HT40)	5190	1	4	156	10.21	30.75	Pass
NVNT	802.11n(HT40)	5190	1	5	164	11.85	37	Pass
NVNT	802.11n(HT40)	5190	1	6	159	13.44	43.25	Pass
NVNT	802.11n(HT40)	5190	1	7	152	14.96	49.5	Pass
NVNT	802.11n(HT40)	5190	1	8	156	16.52	55.75	Pass
NVNT	802.11n(HT40)	5190	1	9	146	17.98	62	Pass
NVNT	802.11n(HT40)	5190	1	10	138	19.36	68.25	Pass
NVNT	802.11n(HT40)	5190	1	11	137	20.73	74.5	Pass
NVNT	802.11n(HT40)	5190	1	12	207	22.8	80.75	Pass
NVNT	802.11n(HT40)	5190	1	13	143	24.23	87	Pass
NVNT	802.11n(HT40)	5190	1	14	161	25.83	93.25	Pass
NVNT	802.11n(HT40)	5190	1	15	175	27.58	99.5	Pass
NVNT	802.11n(HT40)	5190	1	16	7246	100	100	Pass

Idle Period Probability NVNT 802.11a 5180MHz

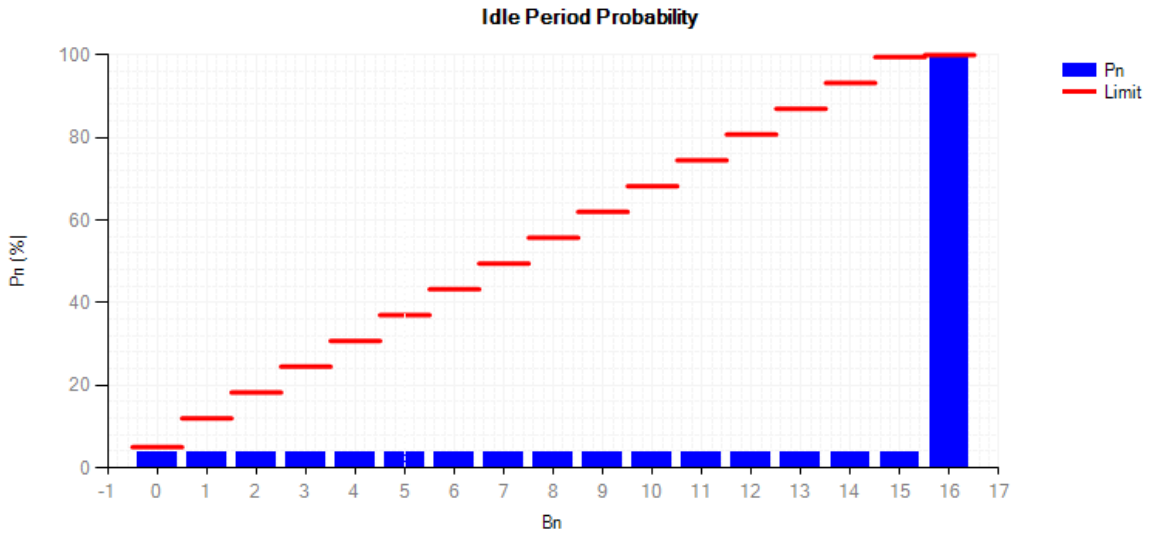

Idle Period Probability NVNT 802.11ac80 5210MHz

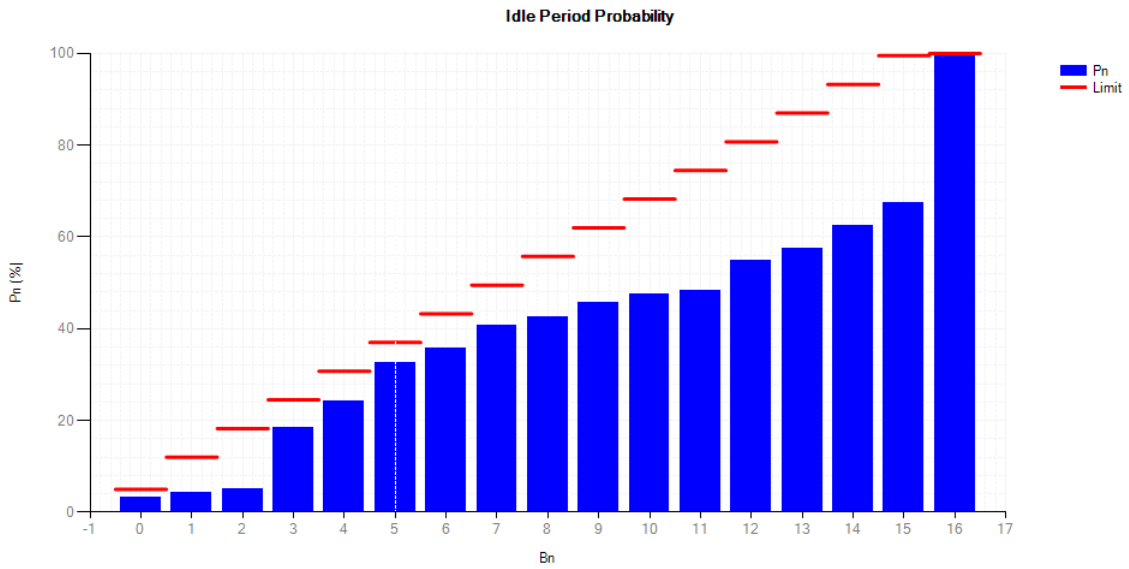

Idle Period Probability NVNT 802.11n(HT40) 5190MHz

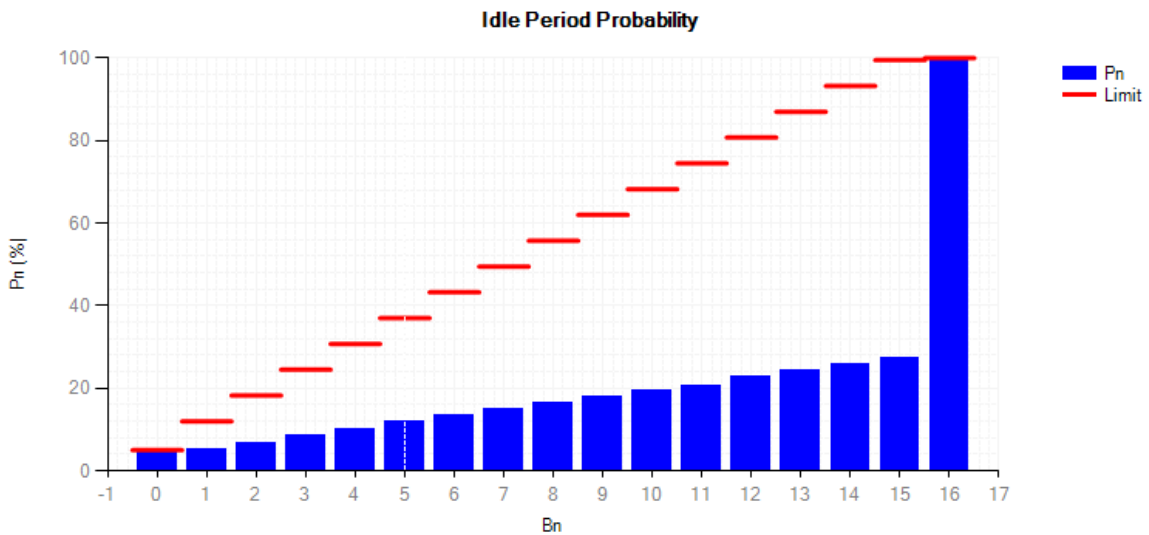



**14. EUT TEST PHOTO**

**SPURIOUS EMISSIONS MEASUREMENT PHOTOS**

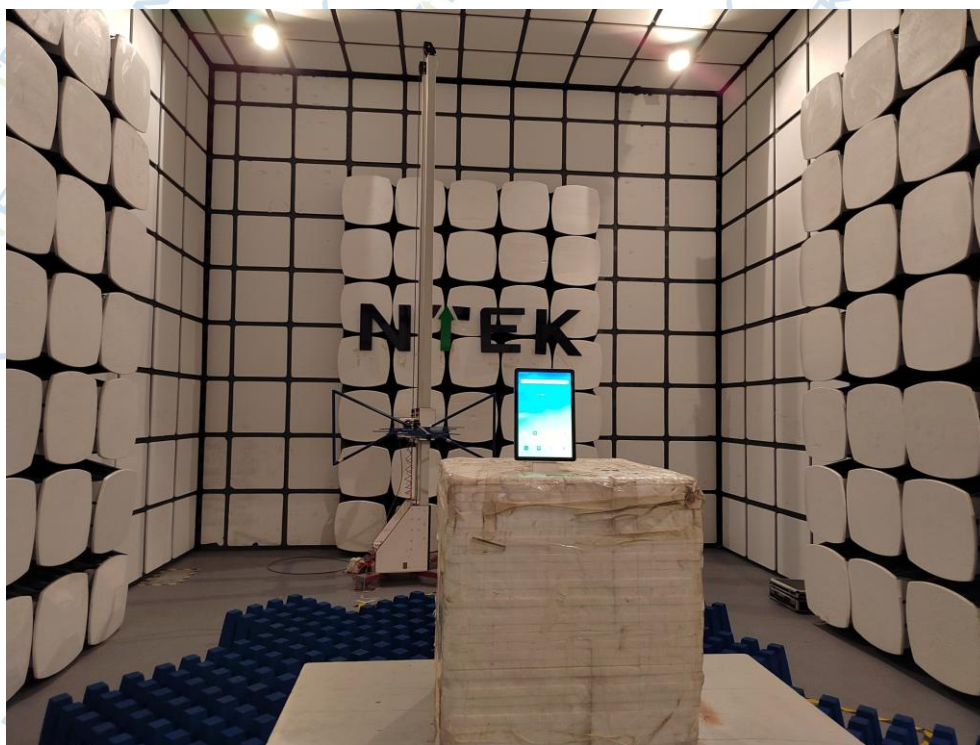

END OF REPORT