

Radio Test Report-2.4G WIFI

ETSI EN 300 328 V2.2.2 (2019-07)

Client Information:

Applicant: DOKE COMMUNICATION (HK) LIMITED
Applicant add.: RM 1902 EASEY COMM BLDG 253-261 HENNESSY ROAD WANCHAI HK CHINA

Product Information:

Product Name: Tablet PC
Model No.: Tab 50 WiFi
Serial Model: Tab 50 Kids
Brand Name: Blackview
Report No.: AIT23070314CW3

Prepared By:

Dongguan Yaxu (AiT) Technology Limited

No.22, Jinqianling Third Street, Jitigang, Huangjiang, Dongguan,
Guangdong, China

Tel.: +86-769-8202 0499 Fax.: +86-769-8202 0495

Date of Receipt: July 13, 2023

Date of Test: July 13, 2023~July 26, 2023

Date of Issue: July 27, 2023

Test Result: Pass

This device has been tested and found to comply with the stated standard(s), which is (are) required by the council directive of 2014/53/EU and indicated in the test report and are applicable only to the tested sample identified in the report.

Note: This report shall not be reproduced except in full, without the written approval of Dongguan Yaxu (AiT) Technology Limited, this document may be altered or revised by Dongguan Yaxu (AiT) Technology Limited, personal only, and shall be noted in the revision of the document. This test report must not be used by the client to claim product endorsement.

Reviewed by:



Simba huang

Approved by:



Seal.chen

1 Contents

	Page
COVER PAGE	
1 CONTENTS	2
2 TEST SUMMARY	4
2.1 COMPLIANCE WITH ETSI EN 300 328 V2.2.2 (2019-07).....	4
3 TEST FACILITY	5
3.1 DEVIATION FROM STANDARD	5
3.2 ABNORMALITIES FROM STANDARD CONDITIONS	5
4 GENERAL INFORMATION	6
4.1 GENERAL DESCRIPTION OF EUT	6
4.2 DESCRIPTION OF TEST SETUP	8
4.3 EUT PERIPHERAL LIST	8
4.4 TEST PERIPHERAL LIST	8
4.5 EQUIPMENTS LIST FOR ALL TEST ITEMS	9
4.6 TEST CONDITIONS	10
4.6.1 Normal conditions	10
4.6.2 Extreme conditions	10
4.7 MEASUREMENT UNCERTAINTY	10
5 TRANSMITTER REQUIREMENTS	11
5.1 RF OUTPUT POWER	11
5.1.1 Limit(ETSI EN 300 328 V2.2.2 (2019-07) Clause 4.3.1.2.3)	11
5.1.2 Test procedure	11
5.1.3 Test Setup	11
5.1.4 Test result	12
5.2 POWER SPECTRAL DENSITY	15
5.2.1 Limit(ETSI EN 300 328 V2.2.2 (2019-07) Clause 4.3.2.3.3)	15
5.2.2 Test procedure	15
5.2.3 Test Setup	15
5.2.4 Test result	16
5.3 OCCUPIED CHANNEL BANDWIDTH	20
5.3.1 Limit(ETSI EN 300 328 V2.2.2 (2019-07) Clause 4.3.2.7.3)	20
5.3.2 Test procedure	20
5.3.3 Test Setup	20
5.3.4 Test result	21
5.4 TRANSMITTER UNWANTED EMISSIONS IN THE OOB DOMAIN	28
5.4.1 Limit(ETSI EN 300 328 V2.2.2 (2019-07) Clause 4.3.2.8.3)	28
5.4.2 Test procedure	28
5.4.3 Test Setup	29
5.4.4 Test result	29
5.5 ADAPTIVITY (CHANNEL ACCESS MECHANISM)	31

5.5.1	Limit(ETSI EN 300 328 V2.2.2 (2019-07) Clause 4.3.2.6).....	31
5.5.2	Test procedure	32
5.5.3	TEST SETUP	32
5.5.4	List of Measurements	33
5.5.5	Test result	34
7.1	TRANSMITTER UNWANTED EMISSIONS IN THE SPURIOUS DOMAIN	60
7.1.1	Limit(ETSI EN 300 328 V2.2.2 (2019-07) Clause 4.3.2.9.3).....	60
7.1.2	Test procedure	60
7.1.3	TEST SETUP	61
7.1.4	Radiated Test result	62
7.1.5	Conducted Test result	63
7.2	RECEIVER SPURIOUS EMISSIONS	64
7.2.1	Limit(ETSI EN 300 328 V2.2.2 (2019-07) Clause 4.3.2.10.3).....	64
7.2.2	Test procedure	64
7.2.3	Test Setup	64
7.2.4	Test result(Radiated measurement)	66
	Test result(Conducted measurement)	67
7.3	RECEIVER BLOCKING	68
7.3.1	Performance Criteria	68
7.3.2	Limit(ETSI EN 300 328 V2.2.2 (2019-07) Clause 4.3.2.11.4).....	68
7.3.3	Test procedure	69
7.3.4	Test Setup	70
7.3.5	Test result	71
8	TEST SETUP PHOTOGRAPH	77

2 Test Summary

2.1 Compliance with ETSI EN 300 328 V2.2.2 (2019-07)

No.	Description of Test Item	Basic Standard	Results
Transmitter Parameters			
1	RF Output Power	EN300328 clause 4.3.2.2	Pass
2	Power Spectral Density	EN300328 clause 4.3.2.3	Pass
3	Duty cycle, Tx-Sequence, Tx-gap	EN300328 clause 4.3.2.4	N/A
4	Medium Utilization (MU) factor	EN300328 clause 4.3.2.5	N/A
5	Adaptivity	EN300328 clause 4.3.2.6	Pass
6	Occupied Channel Bandwidth	EN300328 clause 4.3.2.7	Pass
7	Transmitter unwanted emission in the OOB domain	EN300328 clause 4.3.2.8	Pass
8	Transmitter unwanted emissions in the spurious domain	EN300328 clause 4.3.2.9	Pass
9	Geo-location capability	EN 300 328 Clause 4.3.2.12	N/A
Receiver Parameters			
10	Receiver spurious emissions	EN300328 clause 4.3.2.10	Pass
11	Receiver Blocking	EN300328 clause 4.3.2.11	Pass

3 Test Facility

The test facility is recognized, certified or accredited by the following organizations:

.CNAS- Registration No: L6177

Dongguan Yaxu (AiT) technology Limited is accredited to ISO/IEC 17025:2017 general Requirements for the competence of testing and calibration laboratories (CNAS-CL01 Accreditation Criteria for the competence of testing and calibration laboratories) on April 18, 2022

FCC-Registration No.: 703111 Designation Number: CN1313

Dongguan Yaxu (AiT) technology Limited has been registered and fully described in a report filed with the (FCC) Federal Communications Commission. The acceptance letter from the FCC is maintained in our files.

IC —Registration No.: 6819A CAB identifier: CN0122

The 3m Semi-anechoic chamber of Dongguan Yaxu (AiT) technology Limited has been registered by Certification and Engineering Bureau of Industry Canada for radio equipment testing with Registration No.: 6819A

A2LA-Lab Cert. No.: 6317.01

Dongguan Yaxu (AiT) technology Limited has been accredited by A2LA for technical competence in the field of electrical testing, and proved to be in compliance with ISO/IEC 17025: 2017 General Requirements for the Competence of Testing and Calibration Laboratories and any additional program requirements in the identified field of testing.

3.1 Deviation from Standard

None

3.2 Abnormalities from Standard Conditions

None

4 General Information

4.1 General Description of EUT

Manufacturer:	Shenzhen DOKE Electronic Co.,Ltd
Manufacturer Address:	801, Building3, 7th Industrial Zone, Yulv Community, Yutang Road, Guangming District, Shenzhen, China.
EUT Name:	Tablet PC
Model No:	Tab 50 WiFi
Serial Model:	Tab 50 Kids
Brand Name:	Blackview
Operation Frequency:	802.11b/g/n/ax (20MHz): 2412~2472MHz,802.11n/ax (40MHz):2422~2462MHz
Modulation Type:	IEEE 802.11b :DSSS (DBPSK, DQPSK, CCK) IEEE 802.11g/n/ax: OFDM(64QAM, 16QAM, QPSK, BPSK)
Receiver categories	802.11b,802.11g/n/ax20:1,n/ax40:2
Adaptive/non-adaptive	Adaptive equipment
Antenna Designation	PIFA antenna
Antenna Gain:	4.26dBi
H/W No.:	R863T-RK3562-DK-V1.0
S/W No.:	Tab_50_WiFi_EEA_R863T_V1.0
Adapter:	Model:HJ-0501000N2-EU Input:AC 100-240V~50/60Hz 0.15A Output: DC 5.0V 1.0A 5.0W
Battery:	3.8V, 5580mAh, 21.204Wh
Model difference:	1. In terms of hardware, the Tab 50 WiFi has 4+128GB of memory, and the Tab 50 Kids has 3+64GB of memory. 2. On the software side, Tab 50 Kids adds a kids APP.
Note:	
	1. For a more detailed features description, please refer to the manufacturer's specifications or the User's Manual.

Description of Channel:					
802.11b/g/n/ax(20MHz)					
Channel	Frequency (MHz)	Channel	Frequency (MHz)	Channel	Frequency (MHz)
01	2412	06	2437	11	2462
02	2417	07	2442	12	2467
03	2422	08	2447	13	2472
04	2427	09	2452		
05	2432	10	2457		
802.11n/ax(40MHz)					
03	2422	06	2437	09	2452
04	2427	07	2442	10	2457
05	2432	08	2447	11	2462

4.2 Description of Test setup

EUT was tested in normal configuration (Please See following Block diagrams)

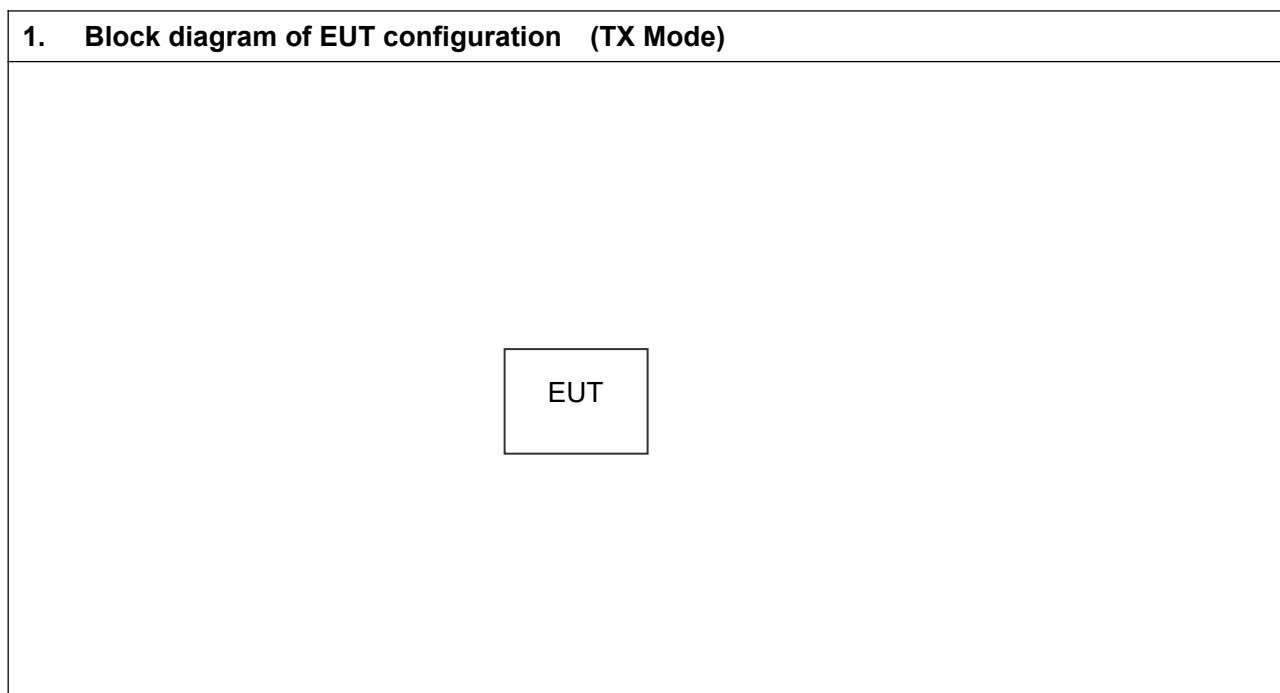

4.3 EUT Peripheral List

No.	Equipment	Manufacturer	Model No.	Serial No.	signal cable	Remark
1	Adapter	Shenzhen Huajin Electronics Co.,Ltd	HJ-0501000N2- EU	N/A	N/A	N/A

4.4 Test Peripheral List

No.	Equipment	Manufacturer	EMC Compliance	Model No.	Serial No.	Power cord	signal cable
1	PC	DELL	--	E7430	N/A	N/A	N/A

4.5 Equipments List for All Test Items

No	Test Equipment	Manufacturer	Model No	Serial No	Cal. Date	Cal. Due Date
1	Spectrum Analyzer	R&S	FSV40	101470	2022.09.02	2023.09.01
2	EMI Measuring Receiver	R&S	ESR	101160	2022.09.02	2023.09.01
3	Low Noise Pre Amplifier	HP	HP8447E	AiT-F01319	2022.09.02	2023.09.01
4	Low Noise Pre Amplifier	Tsj	MLA-0120-A02-34	2648A04738	2022.09.02	2023.09.01
5	Passive Loop	ETS	6512	00165355	2022.09.04	2024.09.03
6	TRILOG Super Broadband test Antenna	SCHWARZBECK	VULB9160	9160-3206	2021.08.29	2024.08.28
7	Broadband Horn Antenna	SCHWARZBECK	BBHA9120D	452	2021.08.29	2024.08.28
8	SHF-EHF Horn Antenna 15-40GHz	SCHWARZBECK	BBHA9170	BBHA9170367d	2020.11.24	2023.11.23
9	EMI Test Receiver	R&S	ESCI	100124	2022.09.02	2023.09.01
10	LISN	Kyoritsu	KNW-242	8-837-4	2022.09.02	2023.09.01
11	LISN	R&S	ESH3-Z2	0357.8810.54 - 101161-S2	2022.09.02	2023.09.01
12	Pro.Temp&Humi.chamber	MENTEK	MHP-150-1C	MAA08112501	2022.09.02	2023.09.01
13	RF Automatic Test system	MW	MW100-RFCB	21033016	2022.09.02	2023.09.01
14	Signal Generator	Agilent	N5182A	MY50143009	2022.09.02	2023.09.01
15	Wideband Radio communication tester	R&S	CMW500	1201.0002K50	2022.09.02	2023.09.01
16	RF Automatic Test system	MW	MW100-RFCB	21033016	2022.09.02	2023.09.01
17	DC power supply	ZHAOXIN	RXN-305D-2	28070002559	N/A	N/A
18	RE Software	EZ	EZ-EMC_RE	Ver.AIT-03A	N/A	N/A
19	CE Software	EZ	EZ-EMC_CE	Ver.AIT-03A	N/A	N/A
20	RF Software	MW	MTS 8310	2.0.0.0	N/A	N/A

4.6 Test conditions

4.6.1 Normal conditions

Ambient:	Temperature:	+15°C to +35°C
	Relative humidity:	20% to 75%
	Press:	1010 mbar
Power supply:	AC	AC 230V for adapter
	DC	3.8V

4.6.2 Extreme conditions

Ambient:	Temperature:	-20 °C to +40 °C (Which declared by manufacture)
Power supply:	DC	3.4-4.2V

4.7 Measurement Uncertainty

No.	Item	Uncertainty
1	Conducted Emission Test	1.20dB
2	Radiated Emission Test	3.75dB
3	RF power,conducted	0.16dB
4	RF power density,conducted	0.24dB
5	Spurious emissions,conducted	0.21dB
6	All emissions,radiated(<1G)	4.68dB
7	All emissions,radiated(>1G)	4.89dB

5 Transmitter Requirements

5.1 RF Output Power

5.1.1 Limit(ETSI EN 300 328 V2.2.2 (2019-07) Clause 4.3.1.2.3)

RF OUTPUT POWER	
Condition	Limit
<input type="checkbox"/> Non-adaptive wide band modulations systems	Equal to or less than the value declared by the supplier. This declared value shall be equal to or less than 20 dBm.
<input checked="" type="checkbox"/> Adaptive wide band modulations systems	≤20dBm

5.1.2 Test procedure

1. Refer to chapter 5.4.2.2 of ETSI EN EN 300 328 V2.2.2(2019-07)
- 2.

Measurement	
<input checked="" type="checkbox"/> Conducted measurement	<input type="checkbox"/> Radiated measurement

5.1.3 Test Setup

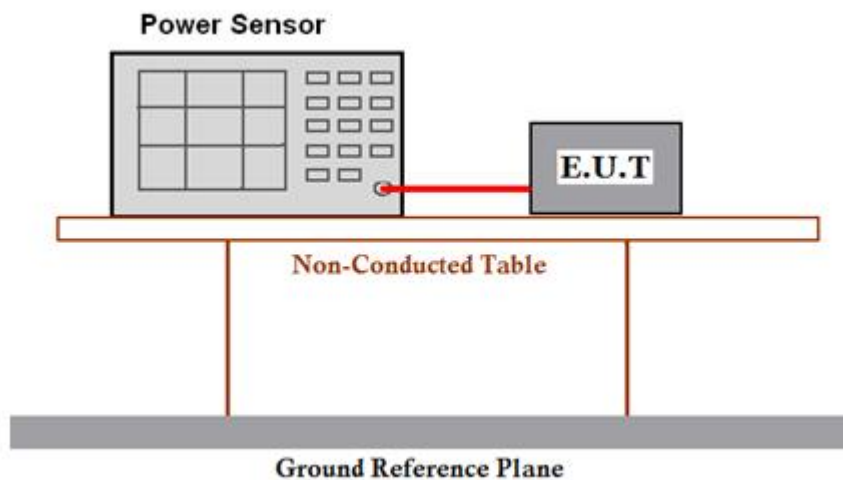

5.1.4 Test result

802.11b

TEST CONDITIONS				Total e.i.r.p (dBm)		
				CH01	CH07	CH13
T nom (°C)	25.00	V nom (V)	3.8	14.43	13.59	12.40
T min (°C)	-20.00	V nom (V)	3.8	14.12	13.36	12.19
T max (°C)	40.00	V nom (V)	3.8	14.36	13.23	11.98
Max e.i.r.p Power				14.43		
Limits				20dBm		
Result				Complies		

Note: Power measurement, actual measurement for 16 Burst power.

802.11g

TEST CONDITIONS				Total e.i.r.p (dBm)		
				CH01	CH07	CH13
T nom (°C)	25.00	V nom (V)	3.8	14.87	14.60	13.86
T min (°C)	-20.00	V nom (V)	3.8	14.37	14.58	13.49
T max (°C)	40.00	V nom (V)	3.8	14.66	14.30	13.68
Max e.i.r.p Power				14.87		
Limits				20dBm		
Result				Complies		

Note: Power measurement, actual measurement for 15 Burst power.

802.11n-HT20

TEST CONDITIONS				Total e.i.r.p (dBm)		
				CH01	CH07	CH13
T nom (°C)	25.00	V nom (V)	3.8	14.94	14.83	14.12
T min (°C)	-20.00	V nom (V)	3.8	14.67	14.51	13.88
T max (°C)	40.00	V nom (V)	3.8	14.59	14.45	14.07
Max e.i.r.p Power				14.94		
Limits				20dBm		
Result				Complies		

Note: Power measurement, actual measurement for 16 Burst power.

802.11n-HT40

TEST CONDITIONS				Total e.i.r.p (dBm)		
				CH03	CH07	CH11
T nom (°C)	25.00	V nom (V)	3.8	14.68	14.69	14.35
T min (°C)	-20.00	V nom (V)	3.8	14.60	14.24	14.11
T max (°C)	40.00	V nom (V)	3.8	14.20	14.51	13.94
Max e.i.r.p Power				14.69		
Limits				20dBm		
Result				Complies		

Note: Power measurement, actual measurement for 16 Burst power.

802.11ax-HE20

TEST CONDITIONS				Total e.i.r.p (dBm)		
				CH01	CH07	CH13
T nom (°C)	25.00	V nom (V)	3.8	15.05	14.83	14.13
T min (°C)	-20.00	V nom (V)	3.8	14.73	14.55	14.08
T max (°C)	40.00	V nom (V)	3.8	15.02	14.48	13.69
Max e.i.r.p Power				15.05		
Limits				20dBm		
Result				Complies		

Note: Power measurement, actual measurement for 16 Burst power.

802.11ax-HE40

TEST CONDITIONS				Total e.i.r.p (dBm)		
				CH03	CH07	CH11
T nom (°C)	25.00	V nom (V)	3.8	14.74	14.63	14.26
T min (°C)	-20.00	V nom (V)	3.8	14.35	14.30	13.85
T max (°C)	40.00	V nom (V)	3.8	14.28	14.48	14.08
Max e.i.r.p Power				14.74		
Limits				20dBm		
Result				Complies		

Note: Power measurement, actual measurement for 16 Burst power.

5.2 Power Spectral Density

5.2.1 Limit(ETSI EN 300 328 V2.2.2 (2019-07) Clause 4.3.2.3.3)

RF OUTPUT POWER	
Condition	Limit
For equipment using wide band modulations other than FHSS	≤10 dBm/MHz

5.2.2 Test procedure

Refer to chapter 5.4.3.2 of ETSI EN EN 300 328 V2.2.2 (2019-07)

Measurement	
<input checked="" type="checkbox"/> Conducted measurement	<input type="checkbox"/> Radiated measurement

The setting of the Spectrum Analyzer

Start Frequency	2400MHz
Stop Frequency	2483.5MHz
Detector	RMS
Sweep Point	> 8 350; for spectrum analysers not supporting this number of sweep points, the frequency band may be segmented
Sweep time	For non-continuous transmissions: 2 × Channel Occupancy Time × number of sweep points For continuous transmissions: 10 s; the sweep time may be increased further until a value where the sweep time has no further impact anymore on the RMS value of the signal
RBW / VBW	10KHz / 30KHz

5.2.3 Test Setup



5.2.4 Test result

Mode	Frequency (MHz)	Max PSD (dBm/MHz)	Limit (dBm/MHz)	Verdict
b	2412	6.61	10	Pass
b	2442	5.89	10	Pass
b	2472	4.65	10	Pass
g	2412	3.49	10	Pass
g	2442	3.22	10	Pass
g	2472	2.51	10	Pass
n20	2412	3.3	10	Pass
n20	2442	3.06	10	Pass
n20	2472	2.72	10	Pass
n40	2422	0.32	10	Pass
n40	2442	0.48	10	Pass
n40	2462	0.48	10	Pass
ax20	2412	2.83	10	Pass
ax20	2442	2.52	10	Pass
ax20	2472	2.17	10	Pass
ax40	2422	-0.18	10	Pass
ax40	2442	0.21	10	Pass
ax40	2462	0.07	10	Pass

Test Plot

(802.11b) PSD plot on channel 1

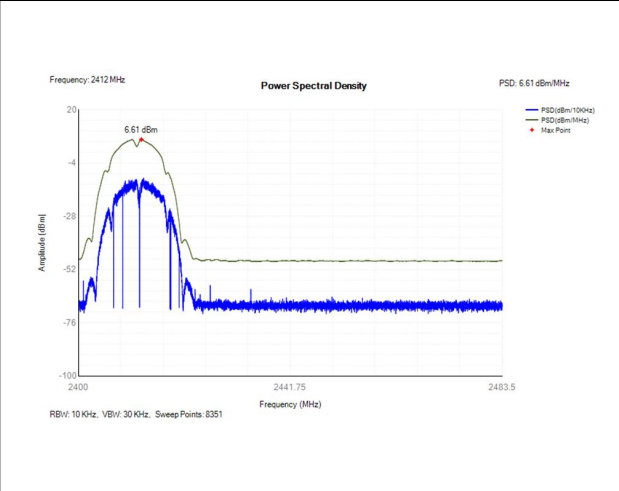

(802.11g) PSD plot on channel 1

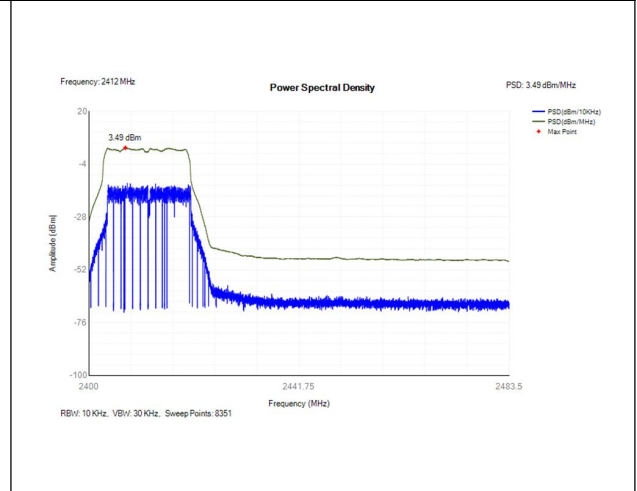

(802.11b) PSD plot on channel 7

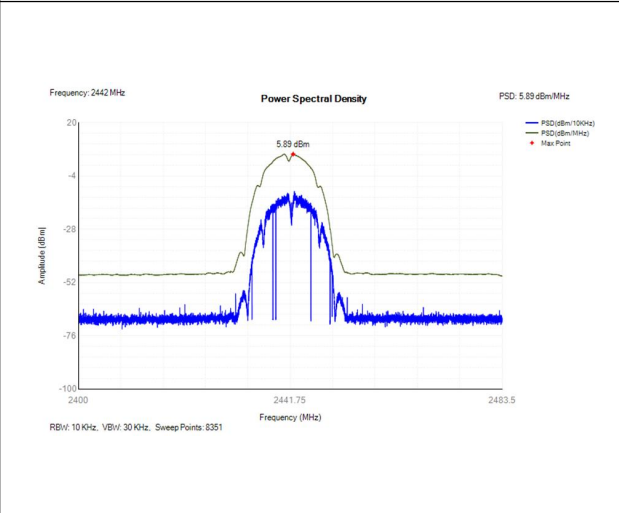

(802.11g) PSD plot on channel 7

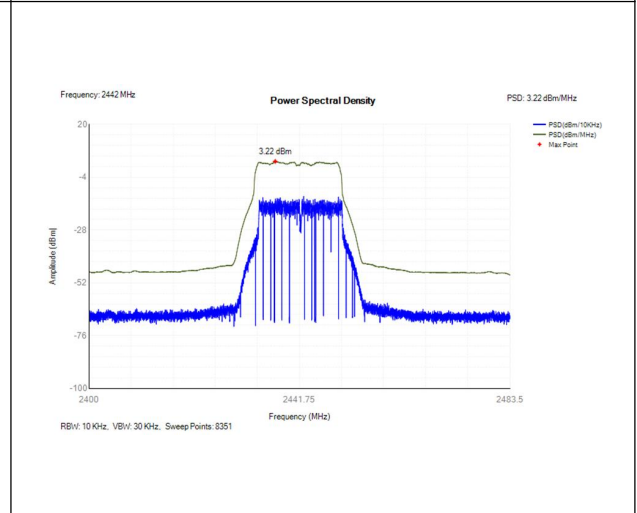

(802.11b) PSD plot on channel 13

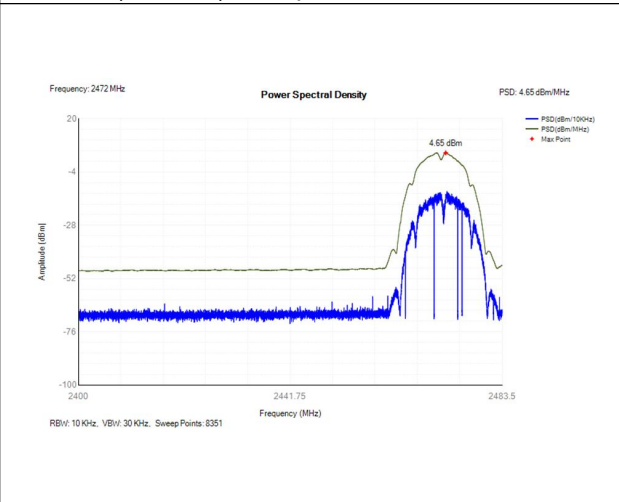

(802.11g) PSD plot on channel 13

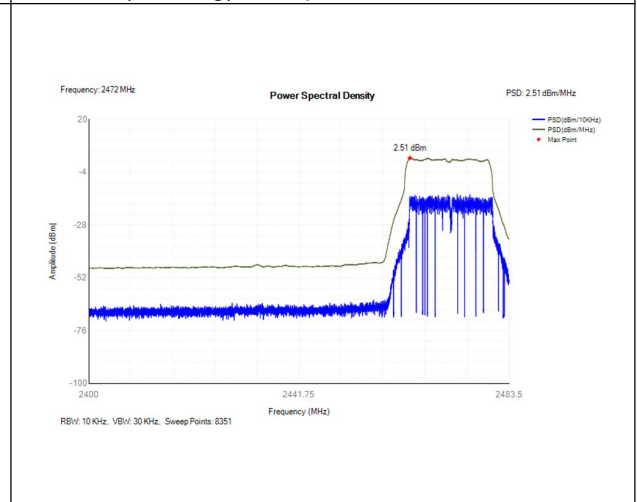

Test Plot

(802.11n20) PSD plot on channel 1

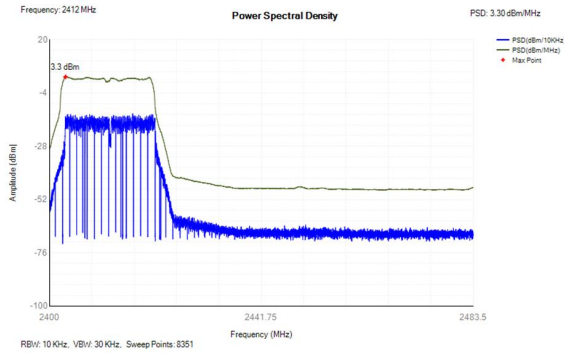

(802.11n40) PSD plot on channel 3

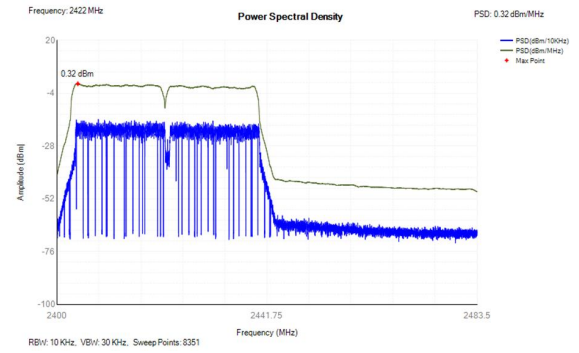

(802.11n20) PSD plot on channel 7

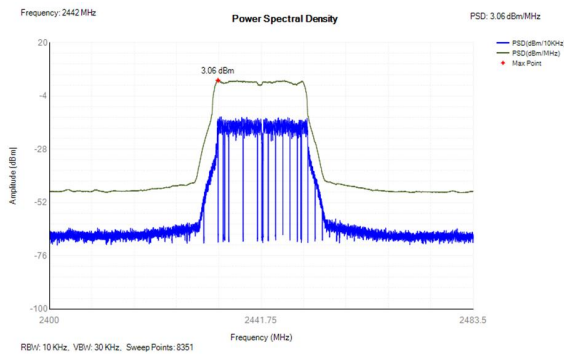

(802.11n40) PSD plot on channel 7

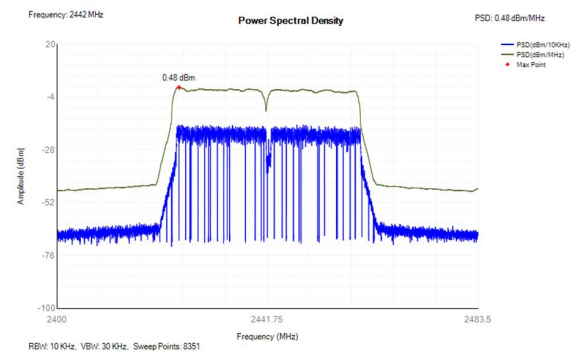

(802.11n20) PSD plot on channel 13

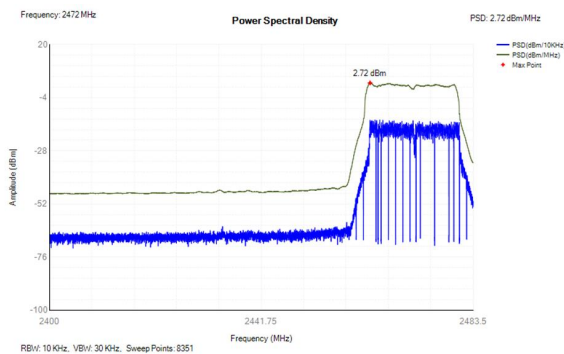

(802.11n40) PSD plot on channel 11

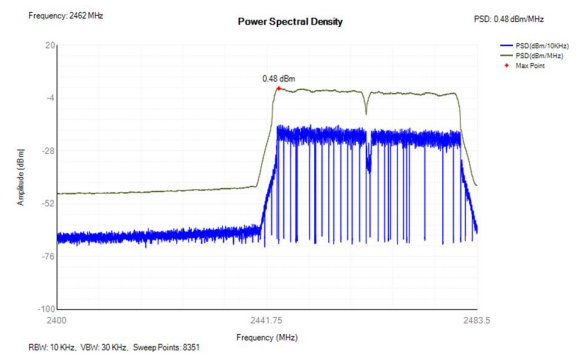

Test Plot

(802.11ax20) PSD plot on channel 1

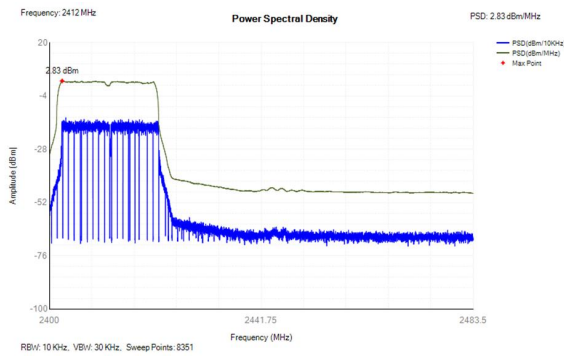

(802.11ax40) PSD plot on channel 3

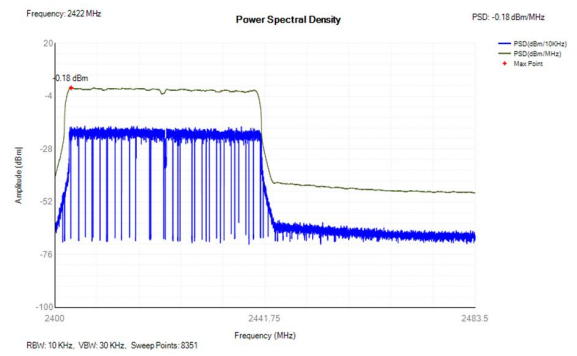

(802.11ax20) PSD plot on channel 7

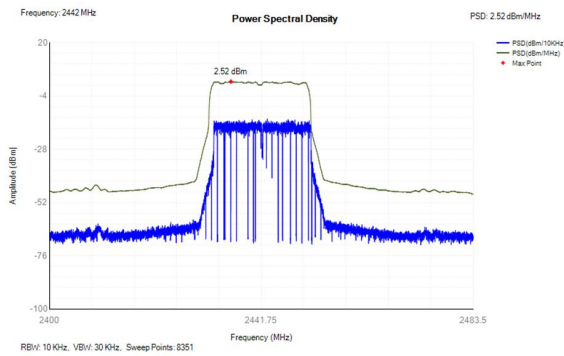

(802.11ax40) PSD plot on channel 7

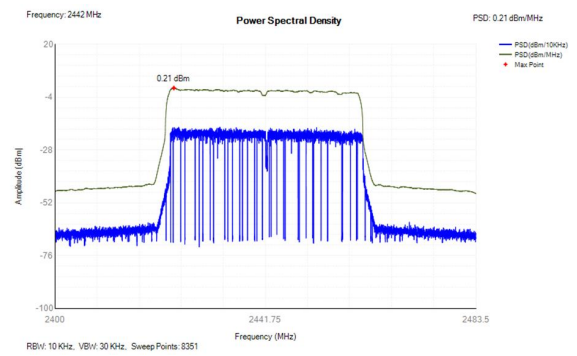

(802.11ax20) PSD plot on channel 13

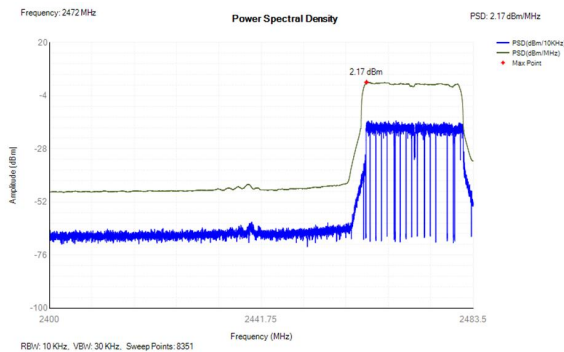

(802.11ax40) PSD plot on channel 11

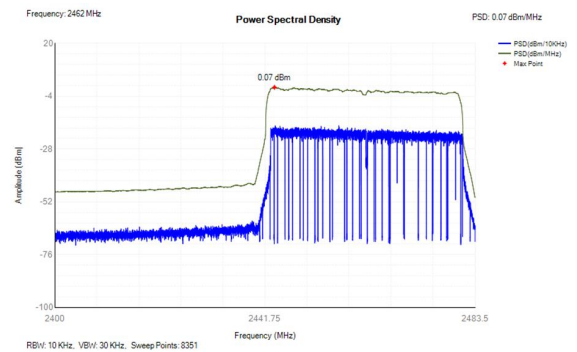

5.3 Occupied Channel Bandwidth

5.3.1 Limit(ETSI EN 300 328 V2.2.2 (2019-07) Clause 4.3.2.7.3)

OCCUPIED CHANNEL BANDWIDTH		
Condition		Limit
All types of equipment		Shall fall completely within the band 2400 to 2483.5 MHz
Additional requirement	For non-adaptive using wide band modulations other than FHSS system and E.I.R.P >10 dBm	Less than 20 MHz
	For non-adaptive frequency hopping system and E.I.R.P >10 dBm	Less than 5 MHz

5.3.2 Test procedure

Refer to chapter 5.4.7.2 of ETSI EN 300 328 V2.2.2 (2019-07)

Measurement	
<input checked="" type="checkbox"/> Conducted measurement	<input type="checkbox"/> Radiated measurement

The setting of the Spectrum Analyzer

Center Frequency	The centre frequency of the channel under test
Frequency Span	2 × Nominal Channel Bandwidth
Detector	RMS
RBW	~ 1 % of the span without going below 1 %
VBW	3 × RBW
Trace	Max hold
Sweep time	1s

5.3.3 Test Setup



5.3.4 Test result

Mode	Frequency (MHz)	Center Frequency (MHz)	OBW (MHz)	Lower Edge (MHz)	Upper Edge (MHz)	Limit OBW (MHz)	Verdict
b	2412	2411.952	12.119	2405.893	2418.011	2400 - 2483.5MHz	Pass
b	2472	2471.928	12.127	2465.865	2477.991	2400 - 2483.5MHz	Pass
g	2412	2411.962	16.802	2403.561	2420.363	2400 - 2483.5MHz	Pass
g	2472	2471.952	16.814	2463.545	2480.359	2400 - 2483.5MHz	Pass
n20	2412	2411.964	17.982	2402.973	2420.955	2400 - 2483.5MHz	Pass
n20	2472	2471.954	17.994	2462.957	2480.951	2400 - 2483.5MHz	Pass
n40	2422	2421.924	36.644	2403.602	2440.246	2400 - 2483.5MHz	Pass
n40	2462	2461.892	36.644	2443.57	2480.214	2400 - 2483.5MHz	Pass
ax20	2412	2411.964	19.174	2402.377	2421.551	2400 - 2483.5MHz	Pass
ax20	2472	2471.956	19.182	2462.365	2481.547	2400 - 2483.5MHz	Pass
ax40	2422	2421.92	38.108	2402.866	2440.974	2400 - 2483.5MHz	Pass
ax40	2462	2461.888	38.092	2442.842	2480.934	2400 - 2483.5MHz	Pass

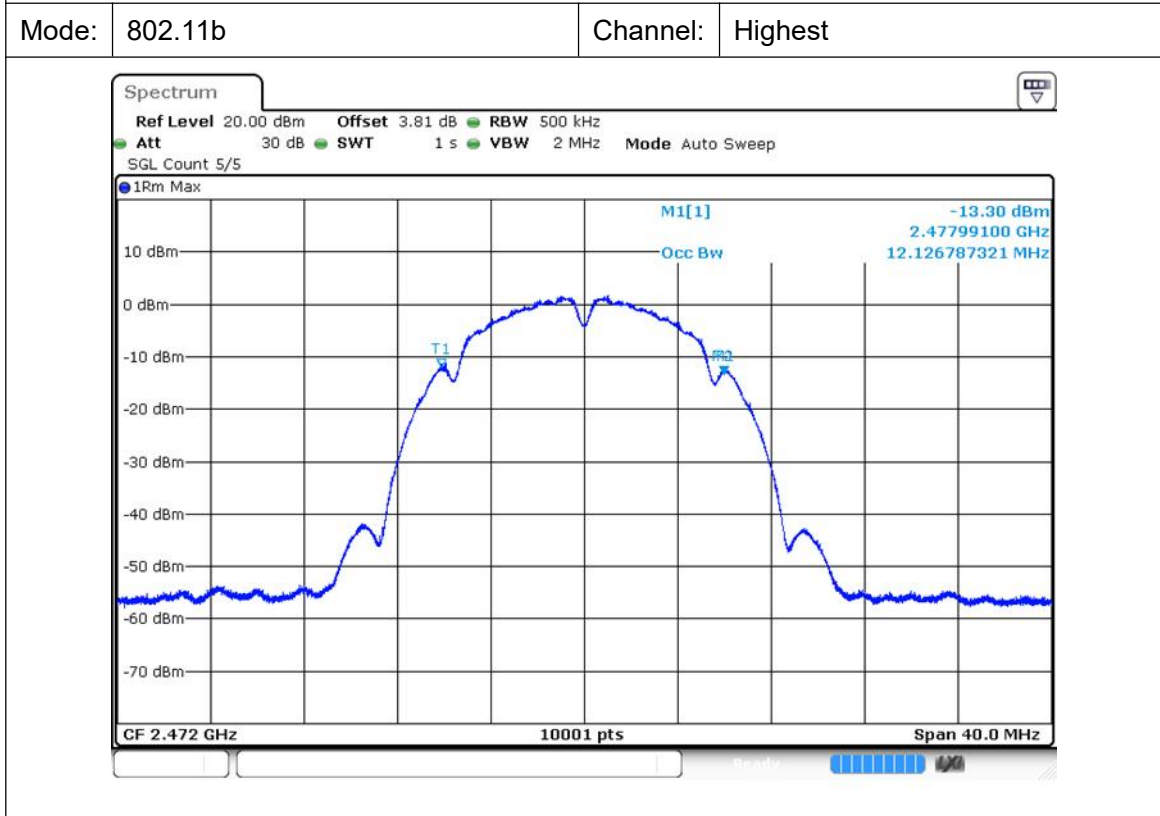
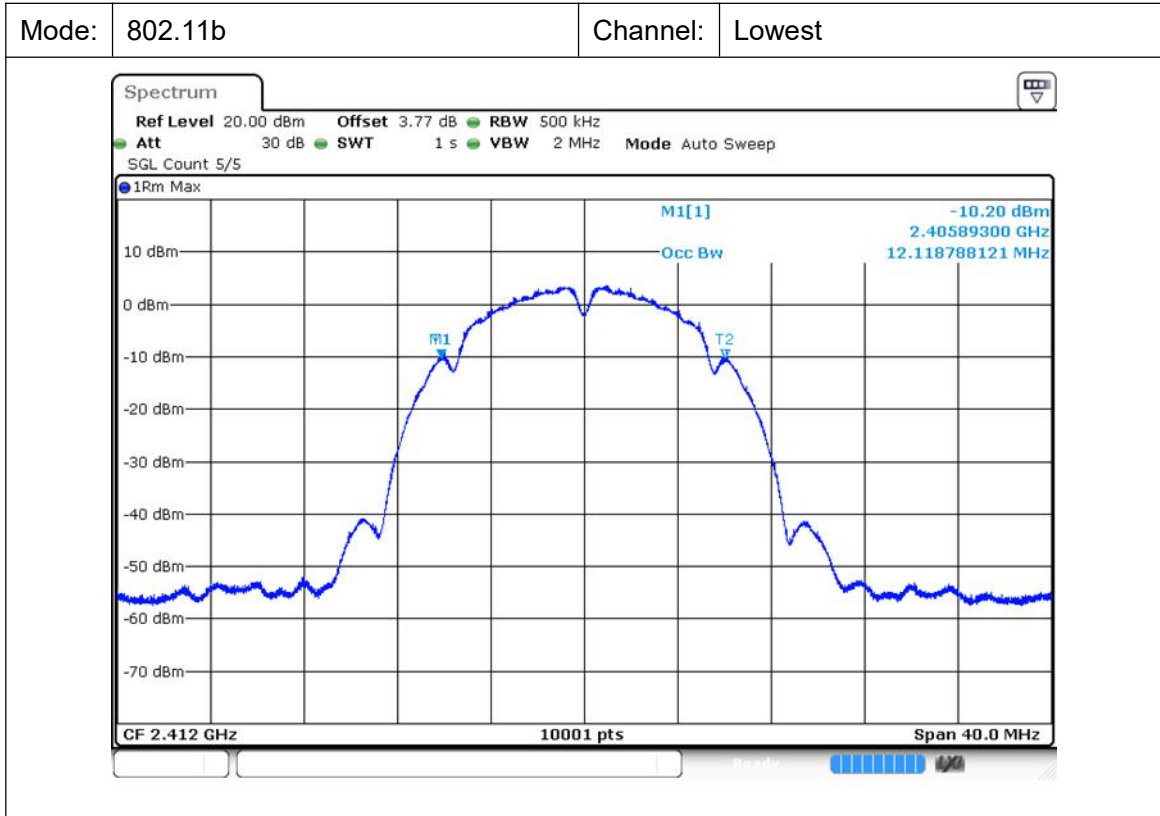

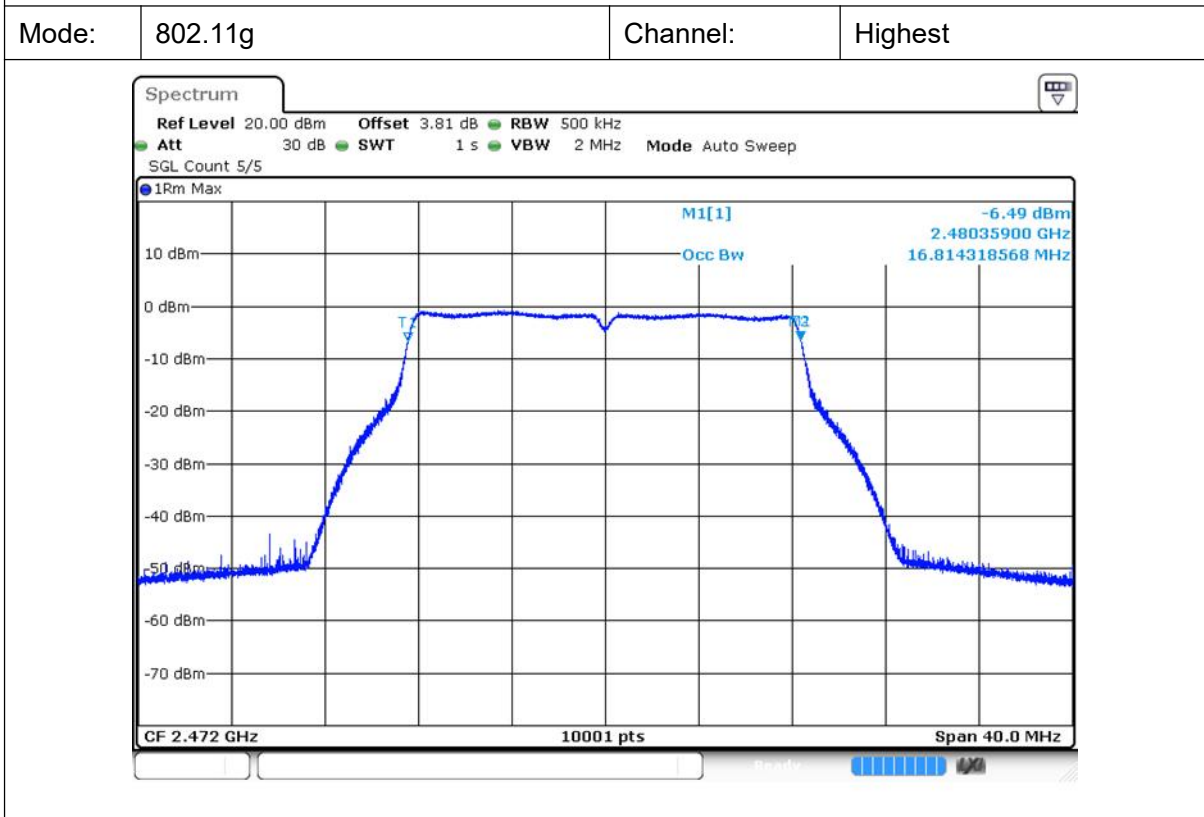
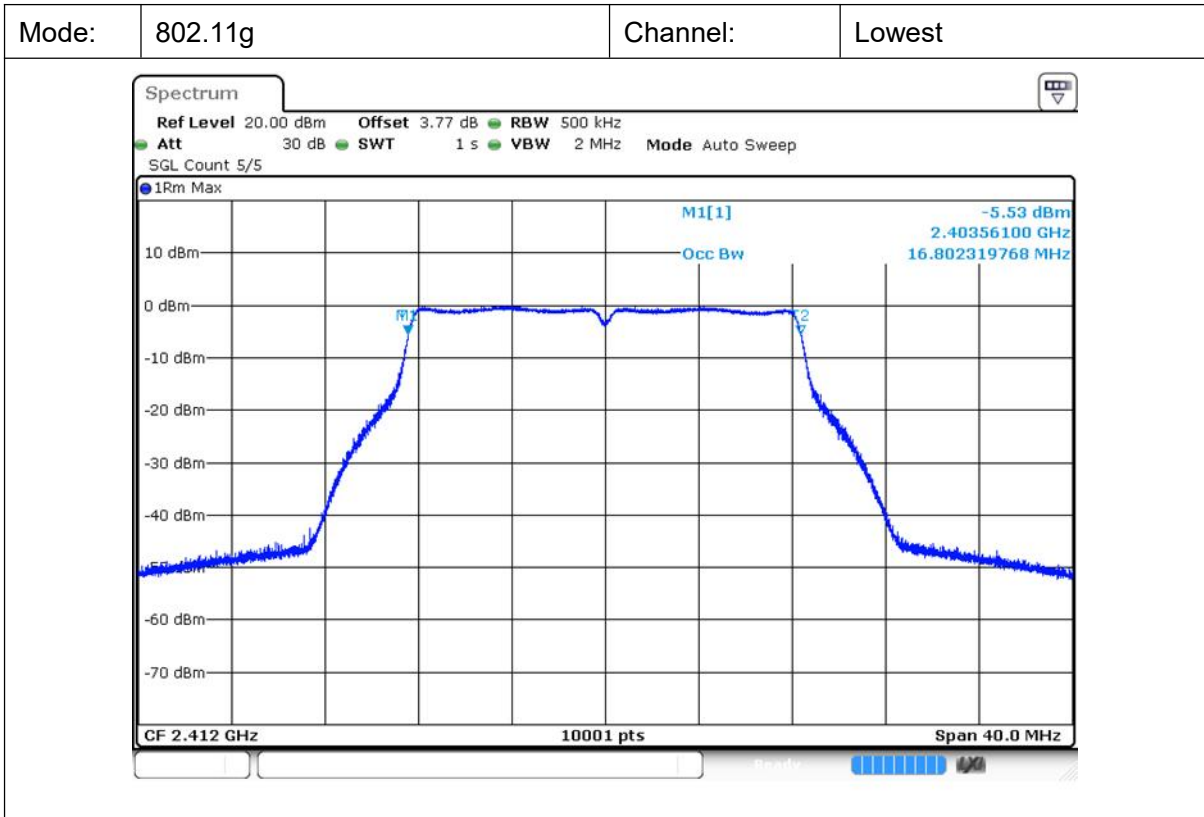

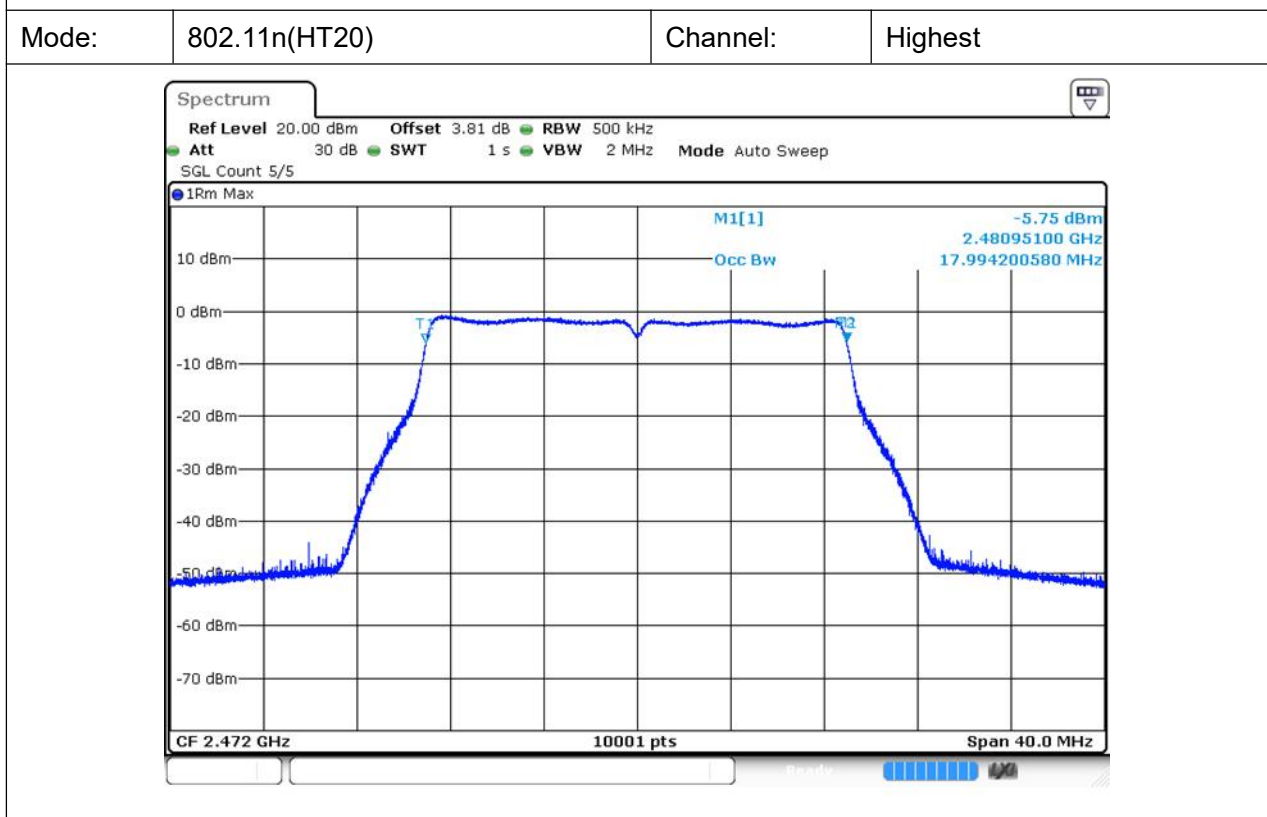
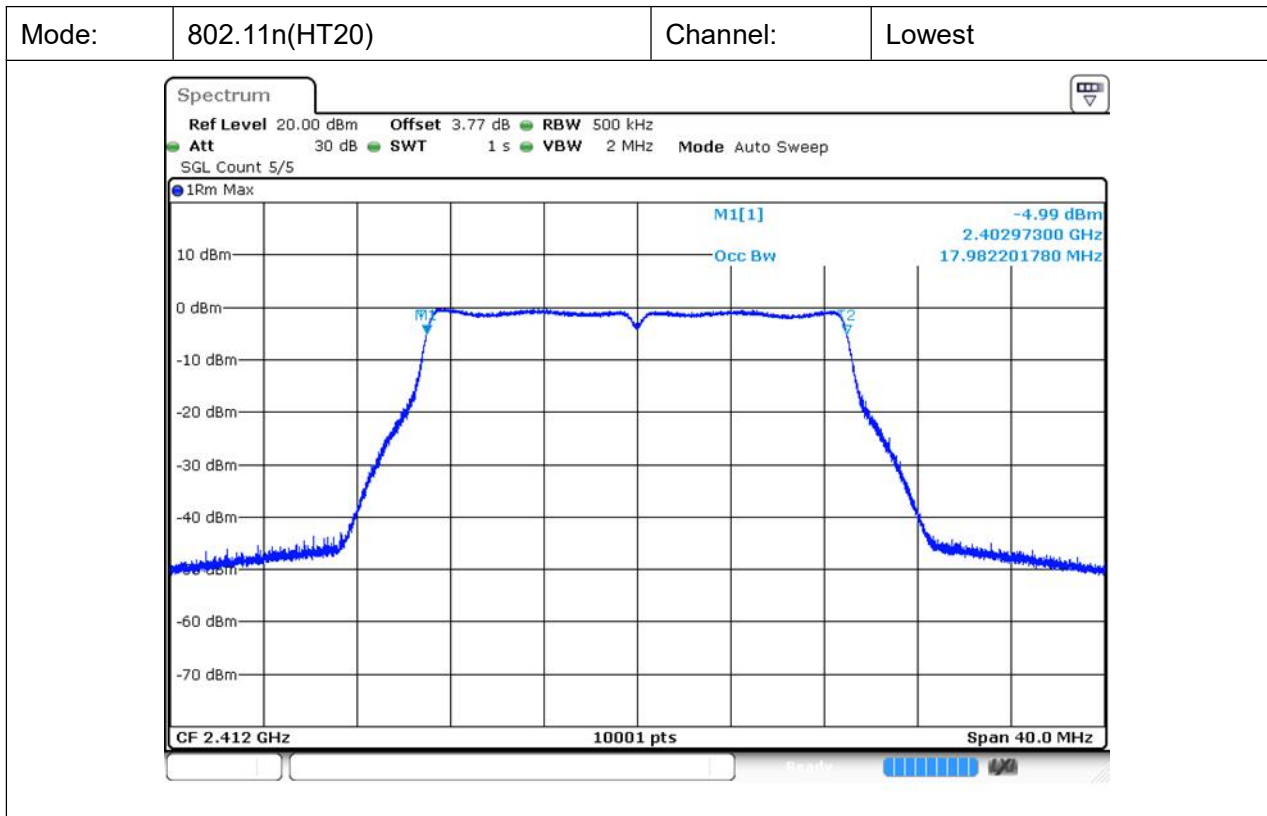

Mode: 802.11n(HT40) Channel: Lowest

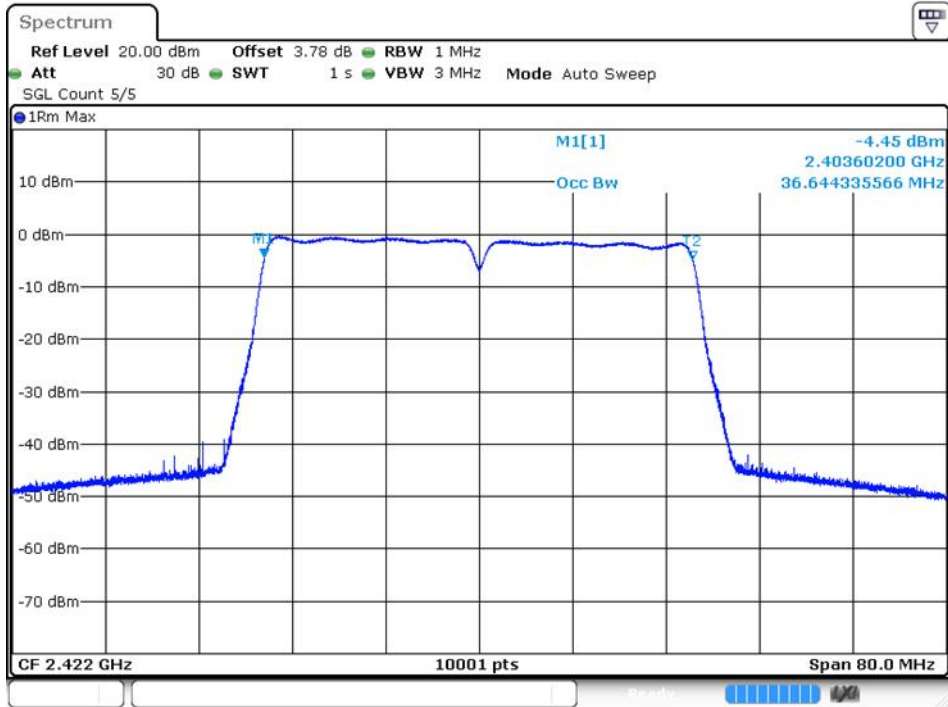

Mode: 802.11n(HT40) Channel: Highest

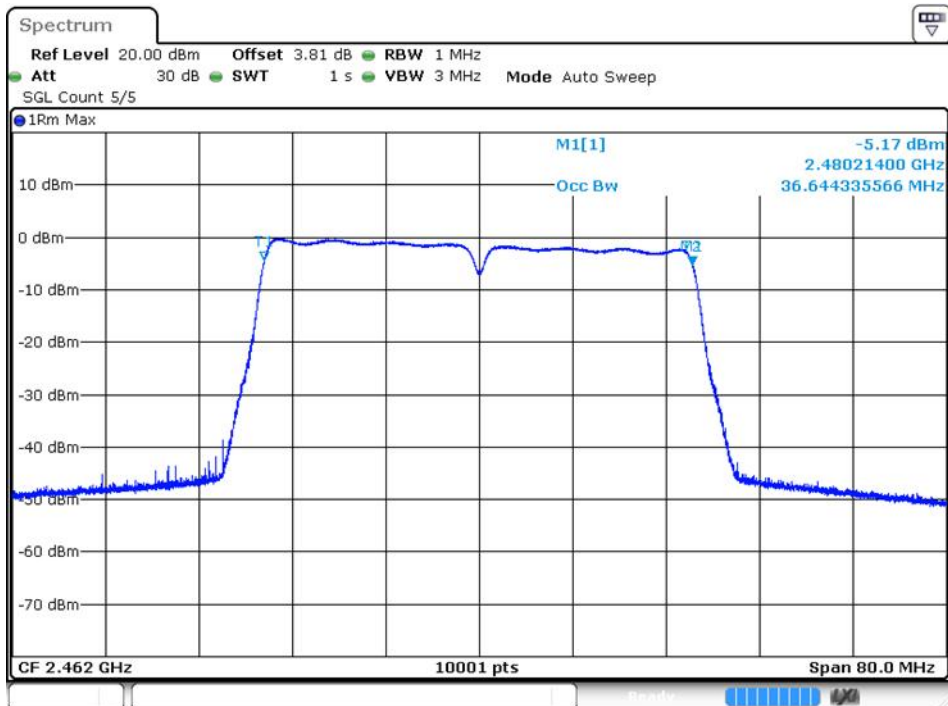

Mode:	802.11ax(HT20)	Channel:	Lowest
-------	----------------	----------	--------

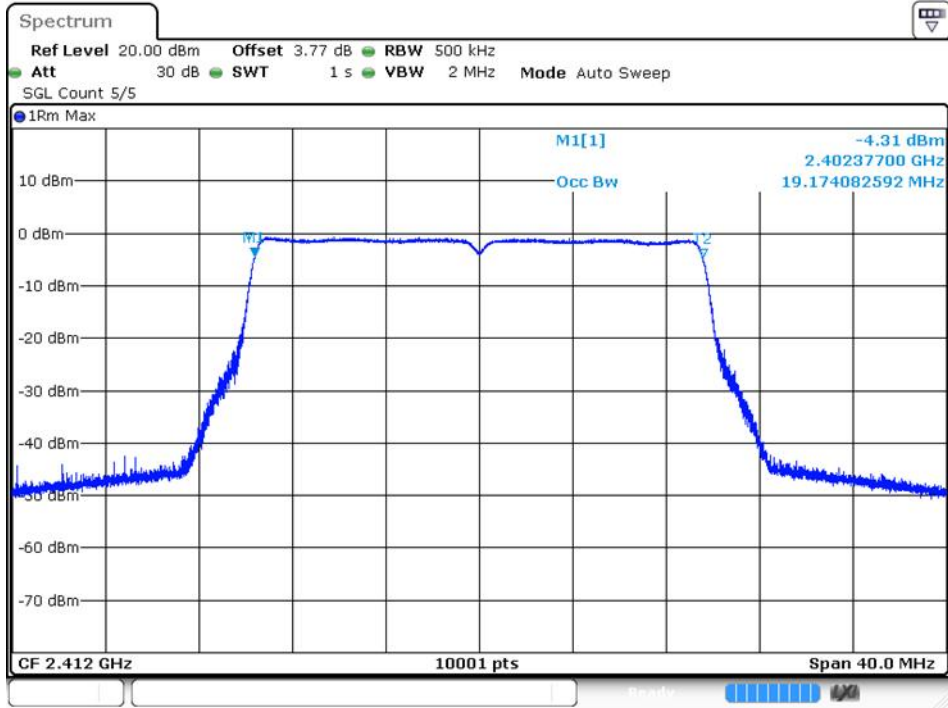

Mode:	802.11ax(HT20)	Channel:	Highest
-------	----------------	----------	---------

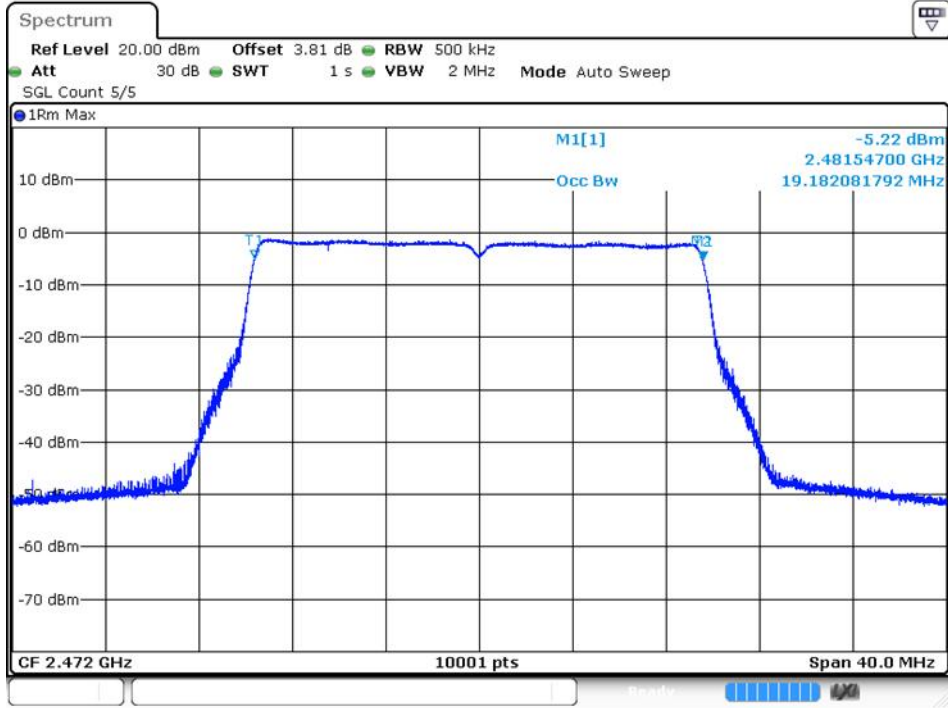

Mode: 802.11ax(HT40) Channel: Lowest

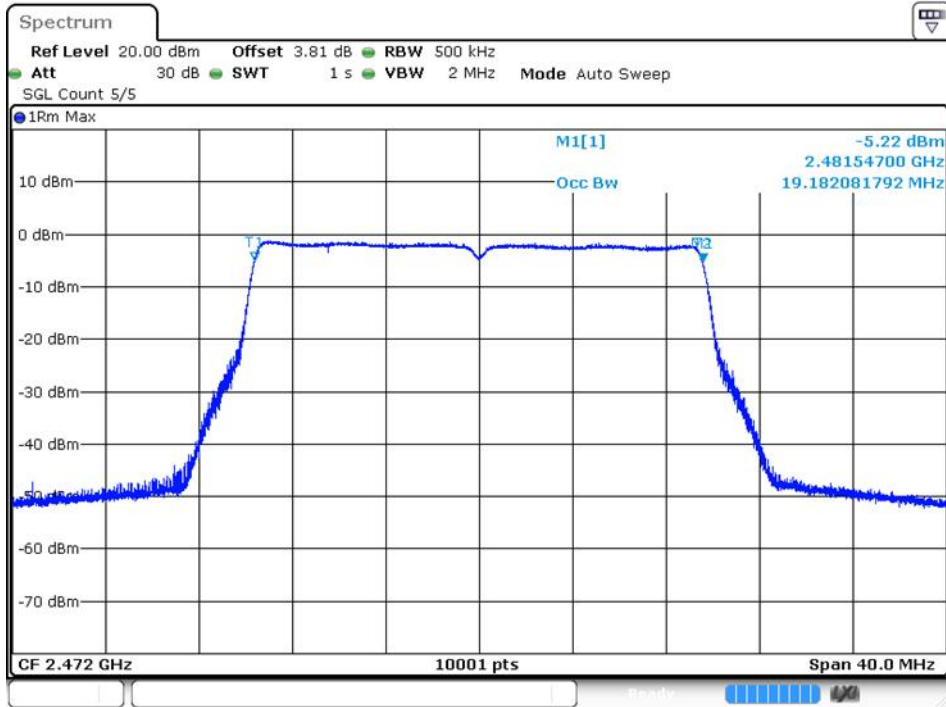

Mode: 802.11ax(HT40) Channel: Highest

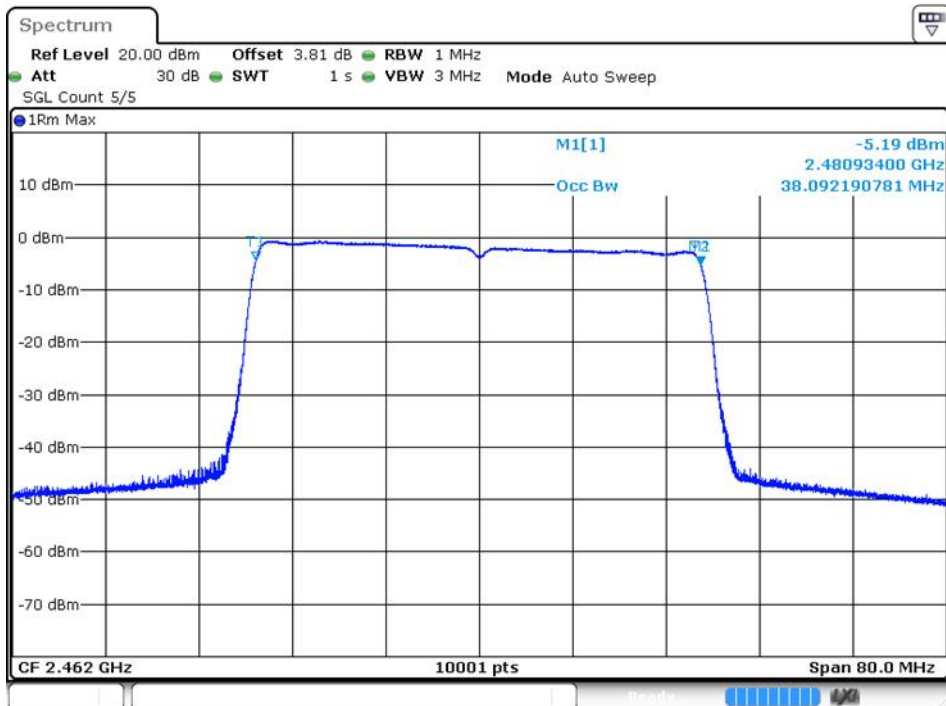

5.4 Transmitter unwanted emissions in the OOB domain

5.4.1 Limit(ETSI EN 300 328 V2.2.2 (2019-07) Clause 4.3.2.8.3)

Transmitter unwanted emissions in the OOB domain	
Condition	Limit
Under all test conditions	The transmitter unwanted emissions in the out-of-band domain but outside the allocated band, shall not exceed the values provided by the mask in below figure.

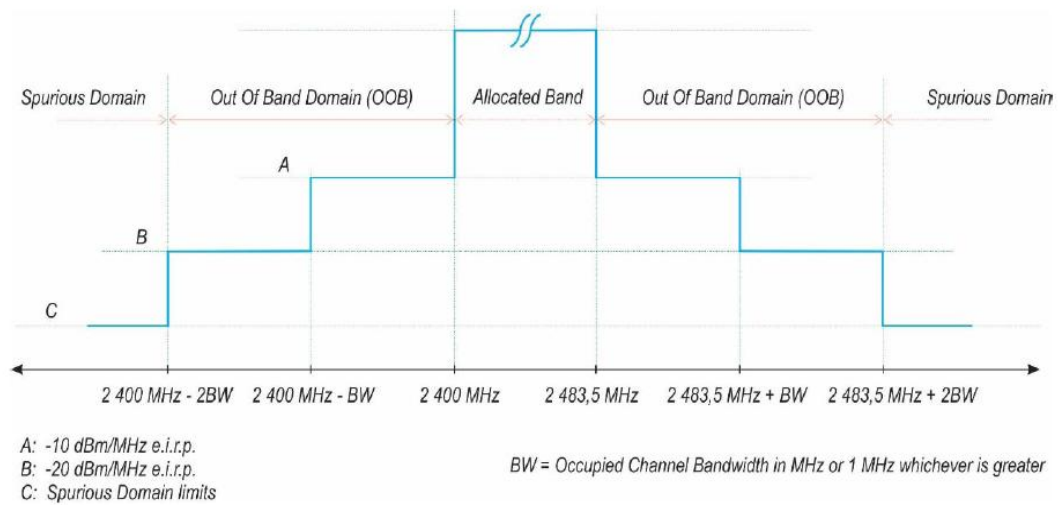

5.4.2 Test procedure

Refer to ETSI EN 300 328 V2.2.2 (2019-07) Clause 5.4.8.2

Measurement	
<input checked="" type="checkbox"/> Conducted measurement	<input type="checkbox"/> Radiated measurement

The setting of the Spectrum Analyzer

Span	0Hz
Filter Mode	Channel Filter
Trace Mode	Max Hold
Trigger Mode	Video trigger; in case video triggering is not possible, an external trigger source may be used
Detector	RMS
Sweep Point / Sweep Mode	Sweep Time [s] / (1 μs) or 5 000 whichever is greater/ Continuous
RBW / VBW	1MHz / 3MHz

5.4.3 Test Setup

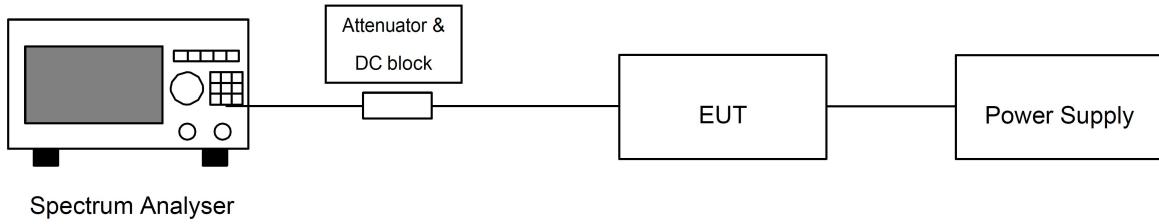

5.4.4 Test result

Measurement Data:

Test plots at normal condition are followed:

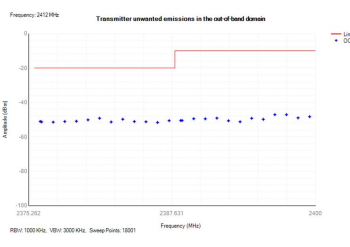
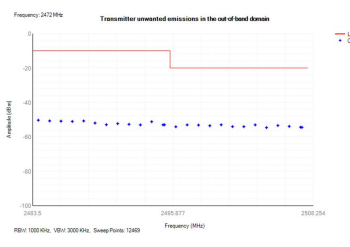
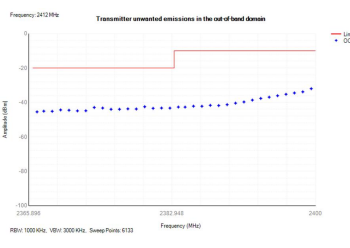
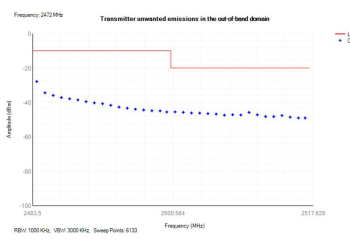
Test Condition:				Normal condition			
Mode:	802.11b	Channel:	Lowest	Mode:	802.11b	Channel:	Highest
							
Mode:	802.11g	Channel:	Lowest	Mode:	802.11g	Channel:	Highest
							

Mode:	802.11n(HT20)	Channel:	Lowest	Mode:	802.11n(HT20)	Channel:	Highest
Mode:	802.11n(HT40)	Channel:	Lowest	Mode:	802.11n(HT40)	Channel:	Highest

Mode:	802.11ax(HT20)	Channel:	Lowest	Mode:	802.11ax(HT20)	Channel:	Highest
Mode:	802.11ax(HT40)	Channel:	Lowest	Mode:	802.11ax(HT40)	Channel:	Highest

5.5 Adaptivity (Channel access mechanism)

5.5.1 Limit(ETSI EN 300 328 V2.2.2 (2019-07) Clause 4.3.2.6)

Requirement	Operational Mode			
	<input type="checkbox"/> Non-LBT based Detect and Avoid	<input type="checkbox"/> LBT based Detect and Avoid		
		<input type="checkbox"/> Frame Based Equipment	<input type="checkbox"/> Load Based Equipment (CCA using 'energy detect')	<input type="checkbox"/> Load Based Equipment (CCA not using any of the mechanisms referenced as note 2)
Minimum Clear Channel Assessment (CCA) Time	NA	not less than 18 us (see note 1)	(see note 2)	not less than 18 us (see note 1)
Maximum Channel Occupancy (COT) Time	<40 ms	1ms to 10 ms	(see note 2)	(13/32)*q ms (see note 3)
Minimum Idle Period	5 % minimum of 100 μs	5% of COT	(see note 2)	NA
Extended CCA check	NA	NA	(see note 2)	R*CCA (see note 4)
Short Control Signalling Transmissions	Maximum duty cycle of 10% within an observation period of 50 ms (see note 5)			

Note 1: The CCA time used by the equipment shall be declared by the supplier.

Note 2: Load Based Equipment may implement an LBT based spectrum sharing mechanism based on the Clear Channel Assessment (CCA) mode using energy detect as described in IEEE 802.11™-2012 [i.3], clause 9, clause 10, clause 16, clause 17, clause 19 and clause 20, or in IEEE 802.15.4™-2011 [i.4], clause 4, clause 5 and clause 8 providing the equipment complies with the conformance requirements referred to in clause 4.3.2.6.3.4.

Note 3: q is selected by the manufacturer in the range [4...32]

Note 4: The value of R shall be randomly selected in the range [1...q]

Note 5: Adaptive equipment may or may not have Short Control Signaling Transmissions.

The detection threshold shall be proportional to the transmit power of the transmitter: for a 20 dBm e.i.r.p. transmitter the detection threshold level (TL) shall be equal to or less than -70 dBm/MHz at the input to the receiver assuming a 0 dBi (receive) antenna assembly. This threshold level (TL) may be corrected for the (receive)antenna assembly gain (G); however, beamforming gain (Y) shall not be taken into account. For power levels less than 20 dBm e.i.r.p., the detection threshold level may be relaxed to:

$$TL = -70 \text{ dBm/MHz} + 10 \times \log_{10} (100 \text{ mW} / P_{out}) \quad (P_{out} \text{ in mW e.i.r.p.})$$

Table 9: Unwanted Signal parameters

Wanted signal mean power from companion device (dBm)	Unwanted signal frequency (MHz)	Unwanted CW signal power (dBm)
-30/ sufficient to maintain the link(see note 2)	2395 or 2488,5 (see note 1)	-35 (see note 2)
<p>NOTE 1: The highest frequency shall be used for testing operating channels within the range 2 400 MHz to 2 442 MHz, while the lowest frequency shall be used for testing operating channels within the range 2 442 MHz to 2 483,5 MHz. See clause 5.4.6.1.</p> <p>NOTE 2: A typical value which can be used in most cases is -50 dBm/MHz.</p> <p>NOTE 3: The level specified is the level in front of the UUT antenna. In case of conducted measurements, this level has to be corrected by the actual antenna assembly gain.</p>		

5.5.2 Test procedure

Refer to ETSI EN 300 328 V2.2.2 (2019-07) Clause 5.4.6.2

Measurement	
<input checked="" type="checkbox"/> Conducted measurement	<input type="checkbox"/> Radiated measurement

5.5.3 TEST SETUP

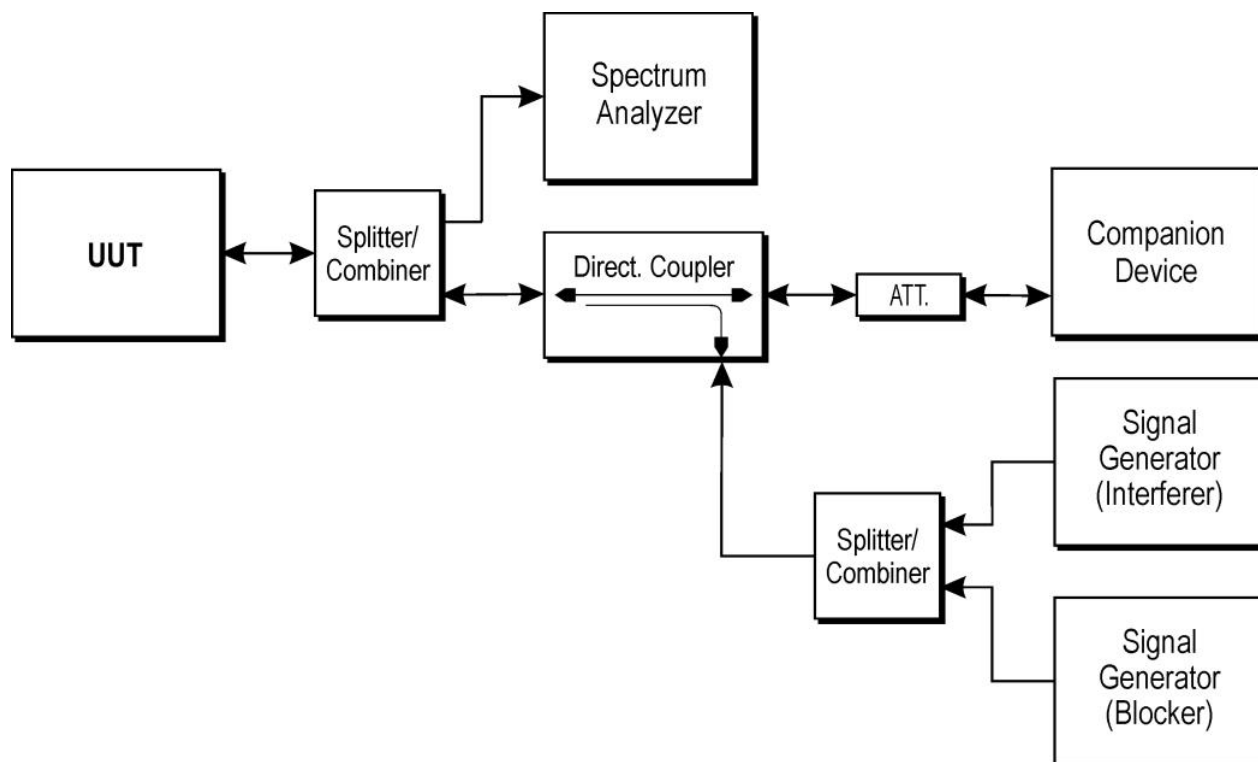

5.5.4 List of Measurements

UUT operational Mode		
Frame Based Equipment	Load Based Equipment (CCA using 'energy detect')	Load Based Equipment (CCA not using any of the mechanisms referenced)
	V	

Clause	Test Parameter	Remarks	PASS/FAIL
4.3.2.5.2.2.1	Adaptive (Frame Based Equipment)	Not Applicable	N/A
4.3.2.5.2.2.2	Adaptive (Load Based Equipment)	Applicable	PASS
4.3.2.5.3	Short Control Signaling Transmissions	Applicable	PASS

5.5.5 Test result

Mode	Frequency (MHz)	AWGN Level (dBm)	CW Level (dBm)	Short Control Width (ms)	Short Control Ratio(%)	Limit (%)	Verdict
b	2412	-60	-35	0	0	<=10	Pass
b	2472	-60	-35	0	0	<=10	Pass
g	2412	-60	-35	0	0	<=10	Pass
g	2472	-60	-35	2.6	5.2	<=10	Pass
n20	2412	-60	-35	3.47	6.94	<=10	Pass
n20	2472	-60	-35	0	0	<=10	Pass
n40	2422	-60	-35	0	0	<=10	Pass
n40	2462	-60	-35	0	0	<=10	Pass
ax20	2412	-60	-35	0	0	<=10	Pass
ax20	2472	-60	-35	0	0	<=10	Pass
ax40	2422	-60	-35	0	0	<=10	Pass
ax40	2462	-60	-35	0	0	<=10	Pass

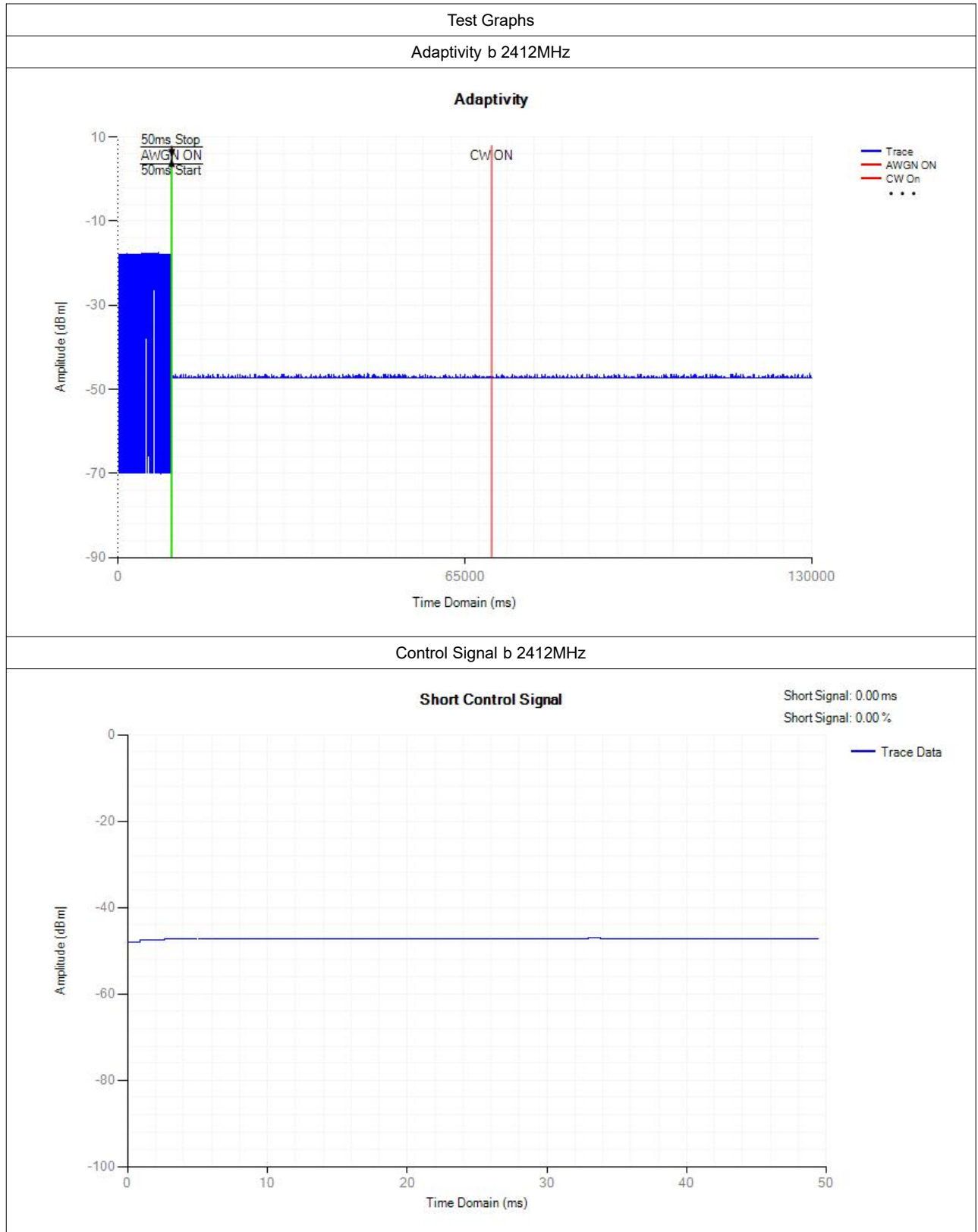

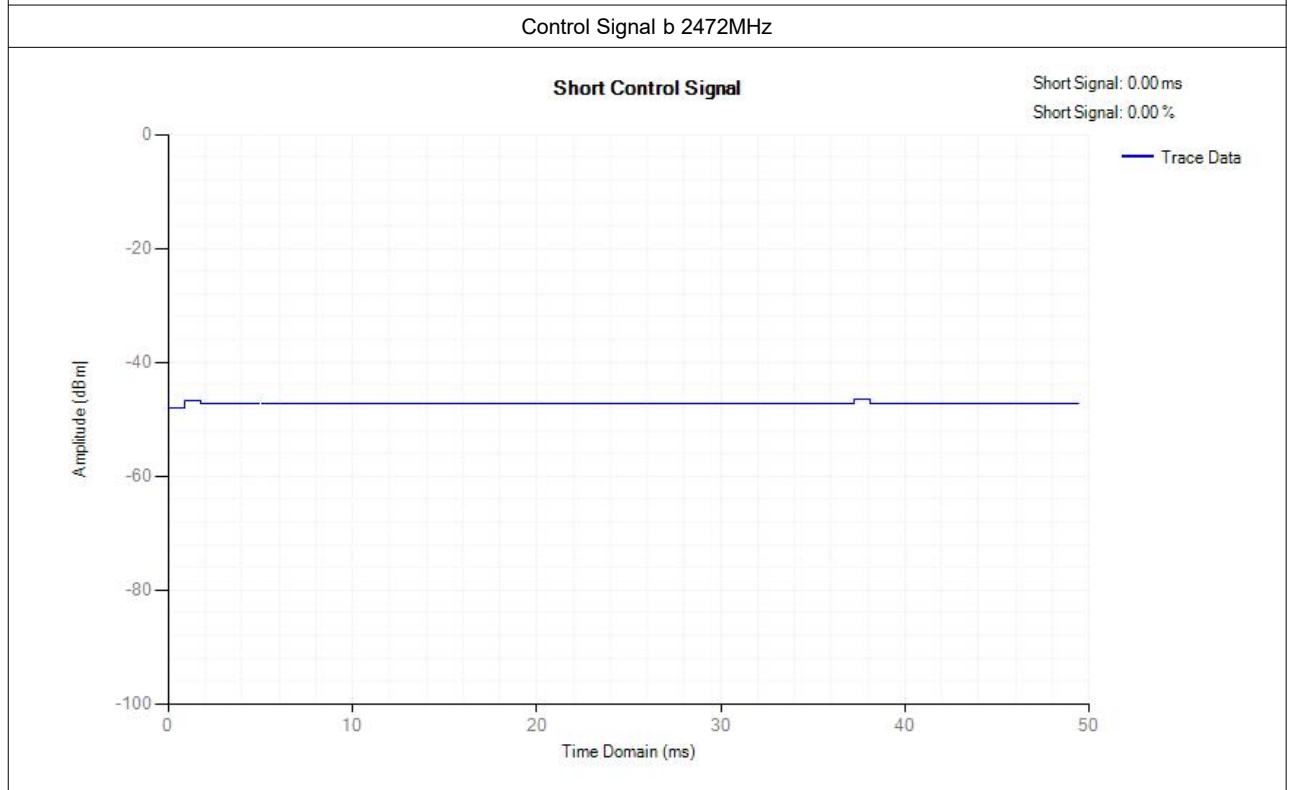
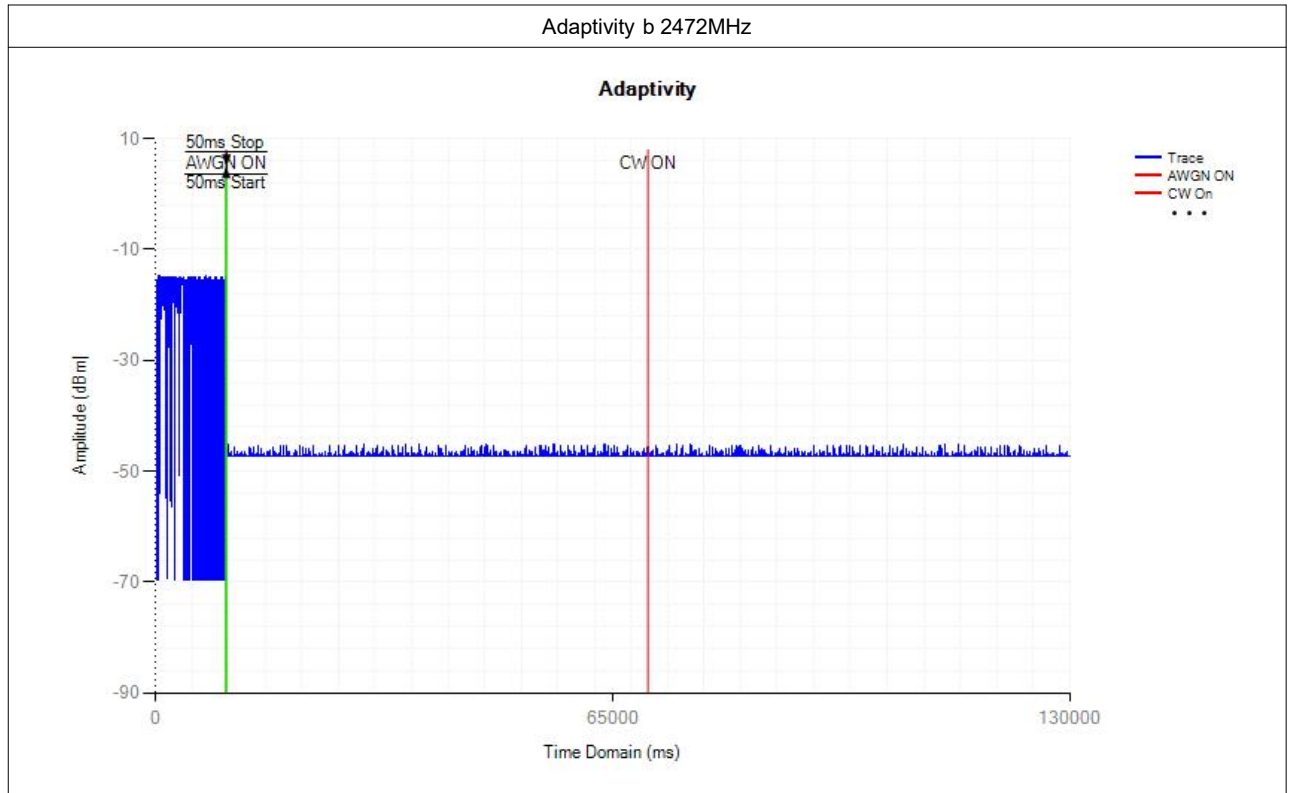

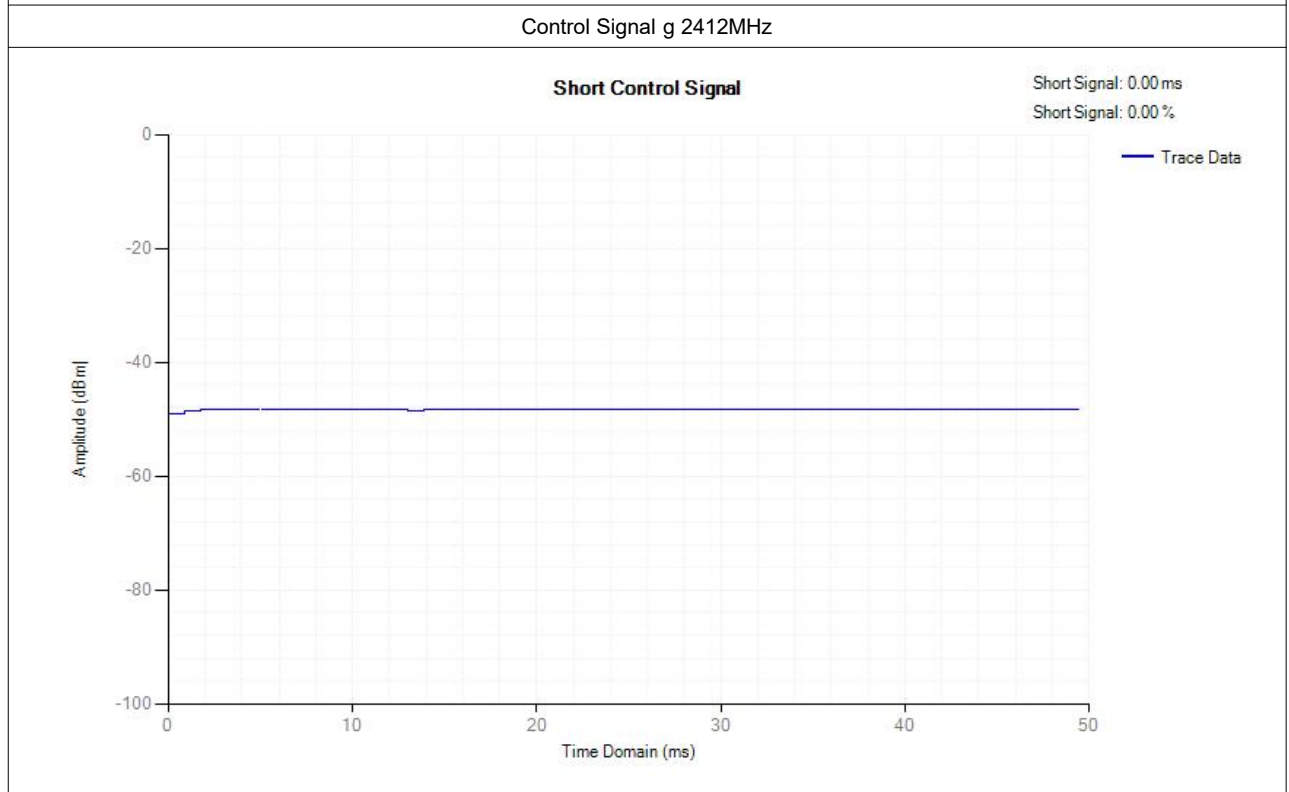
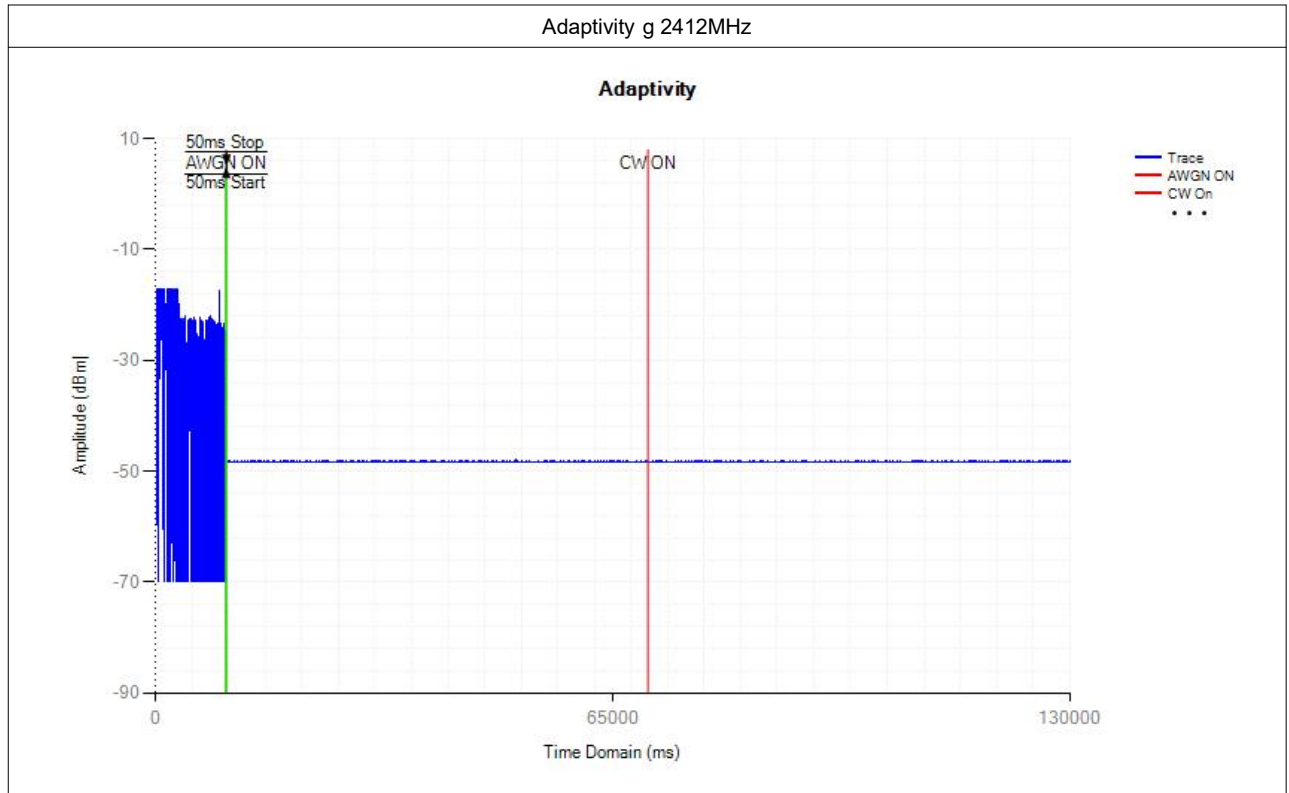

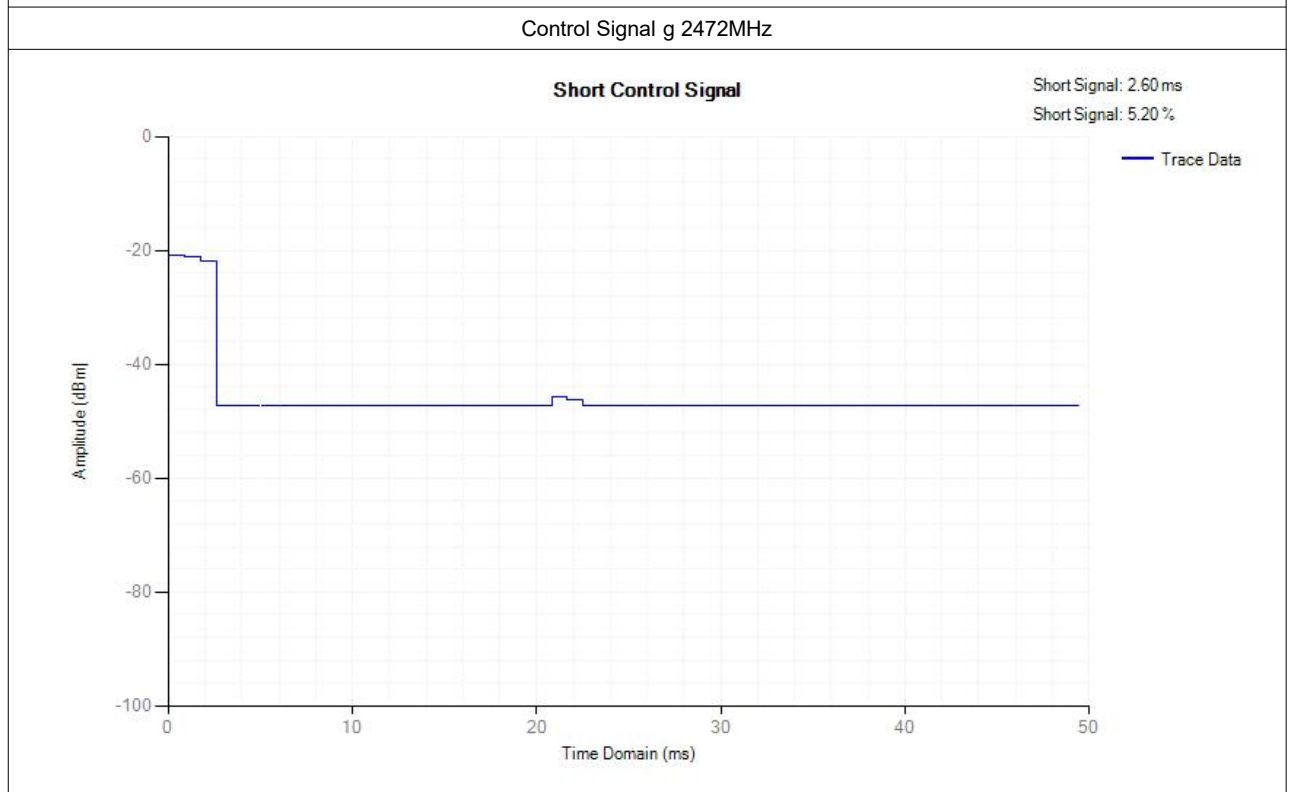
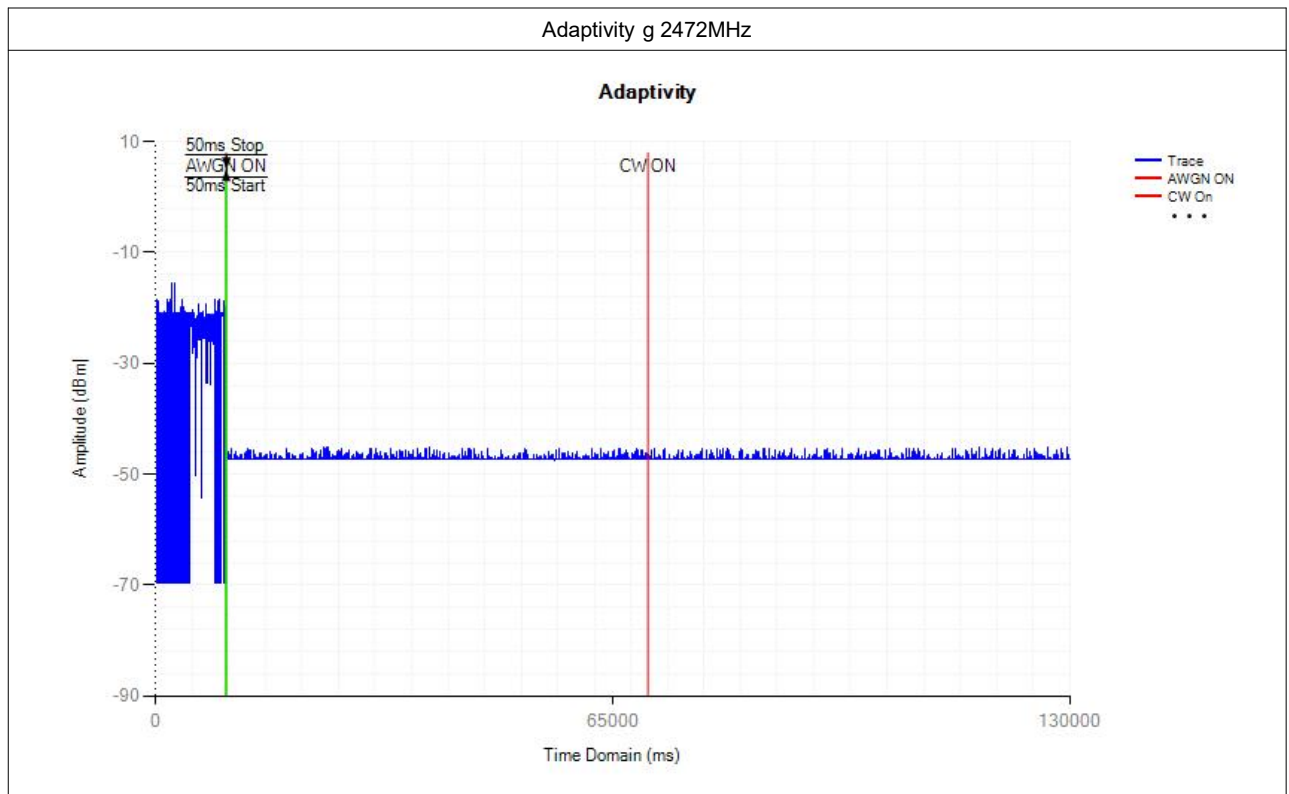

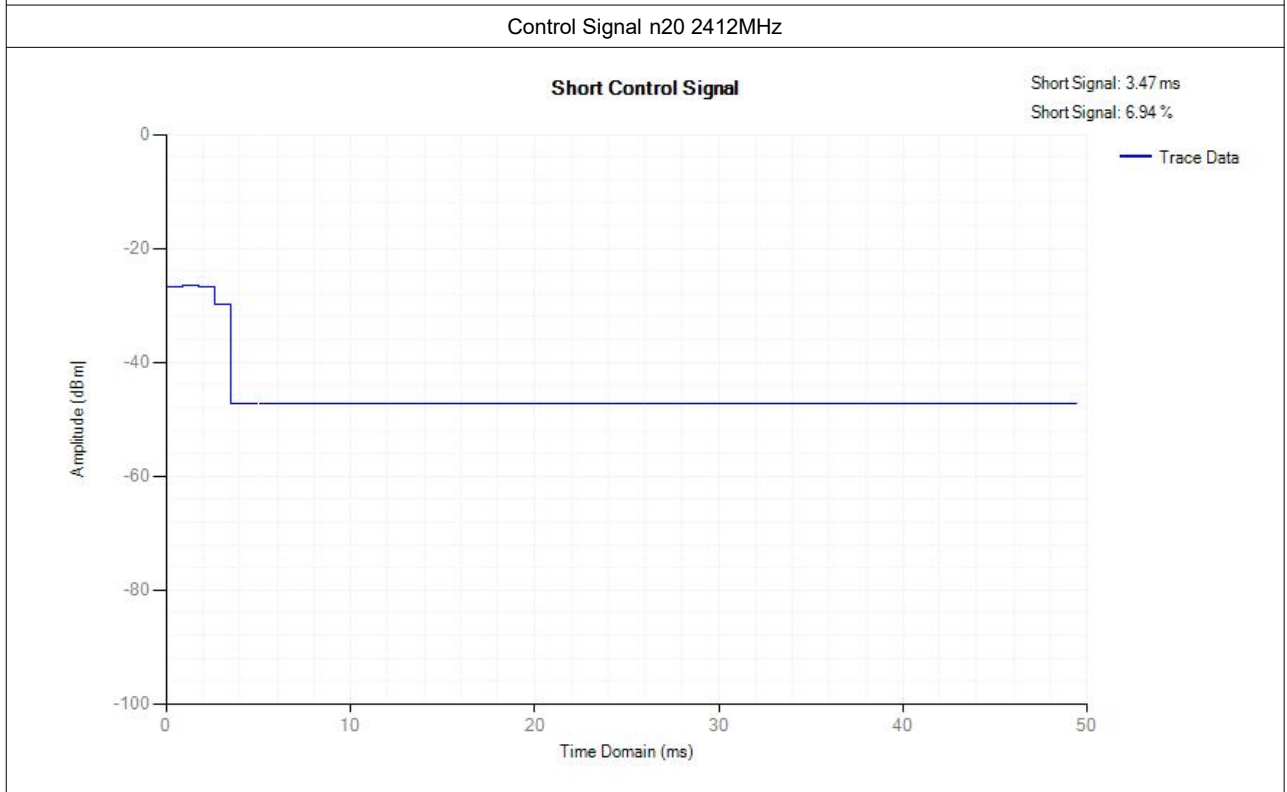
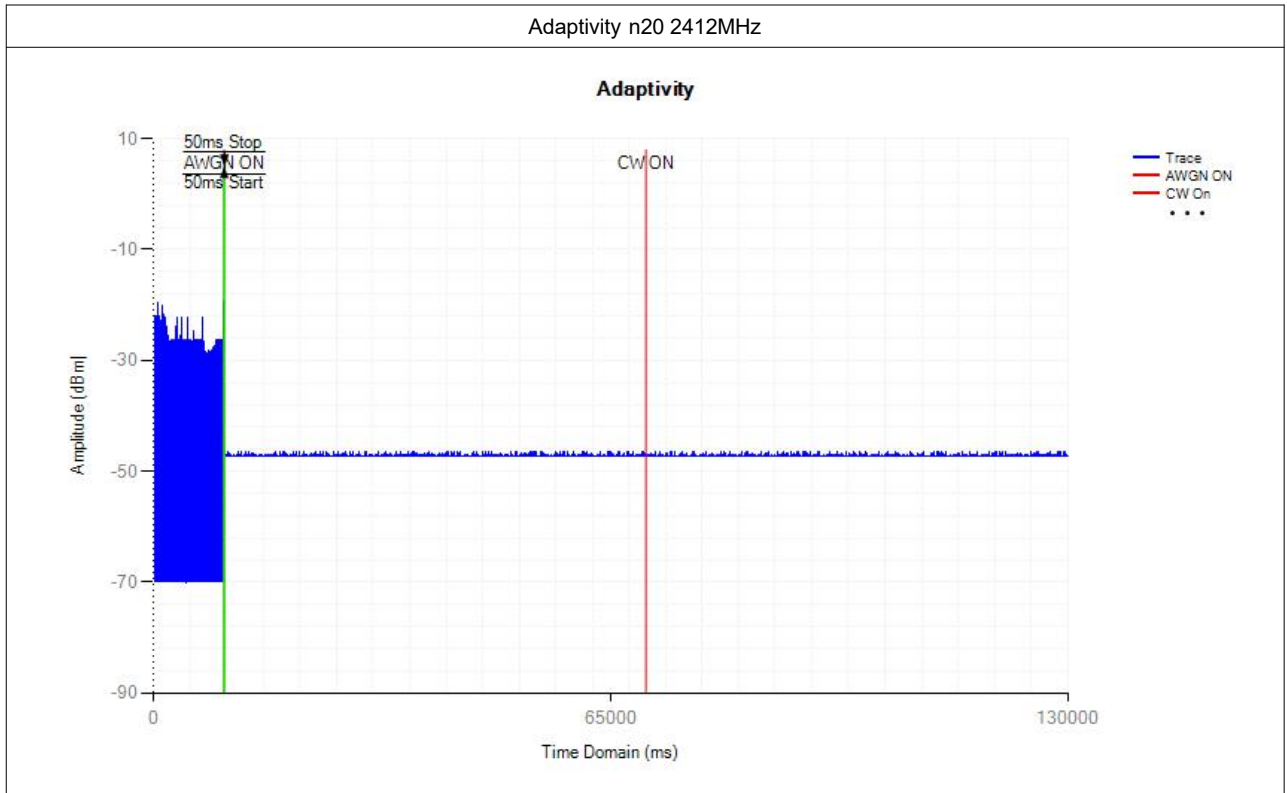

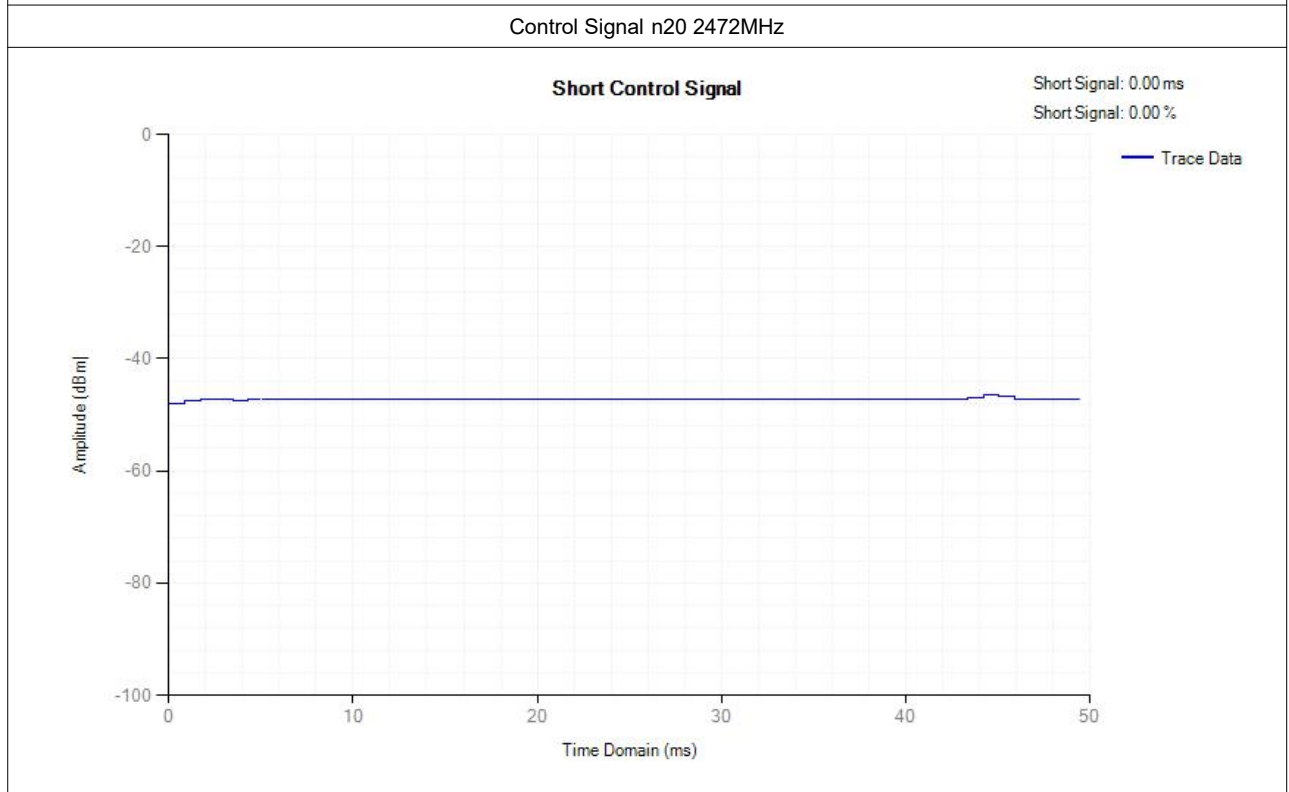
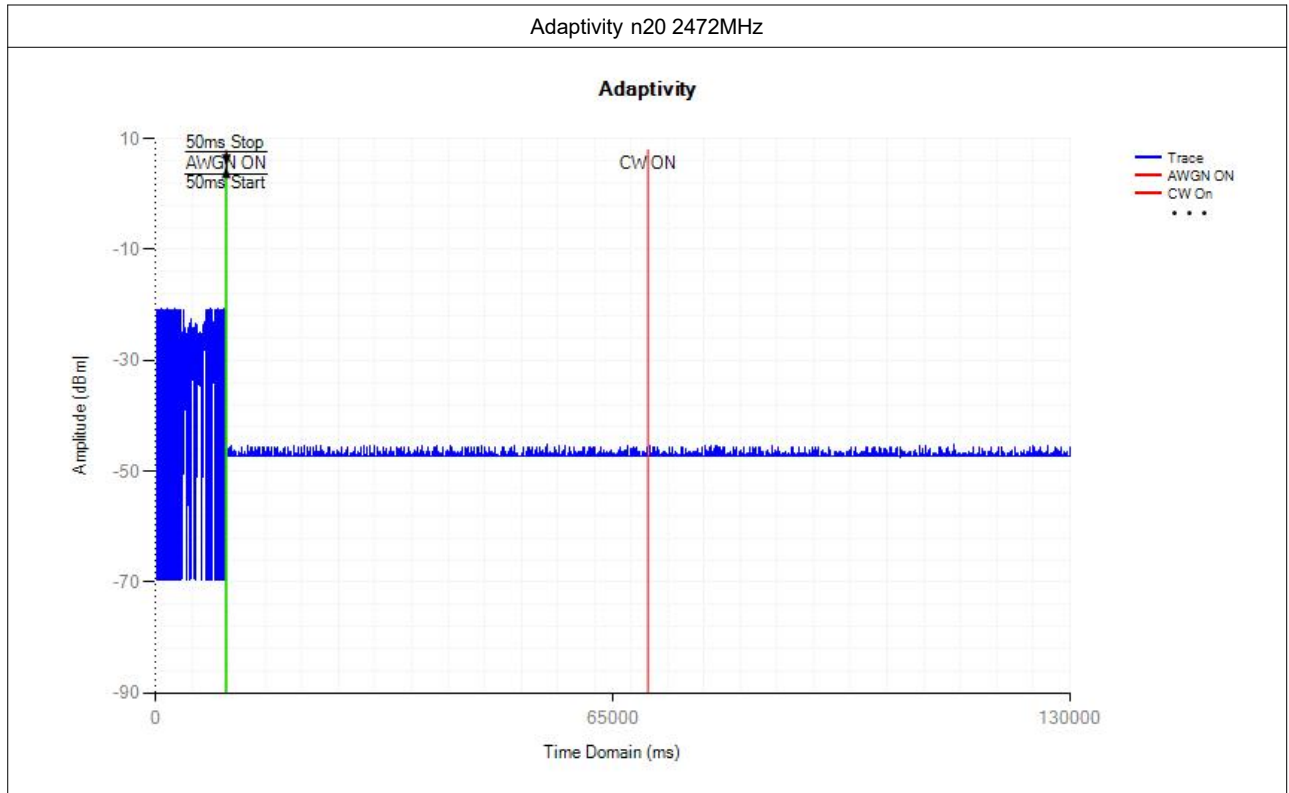

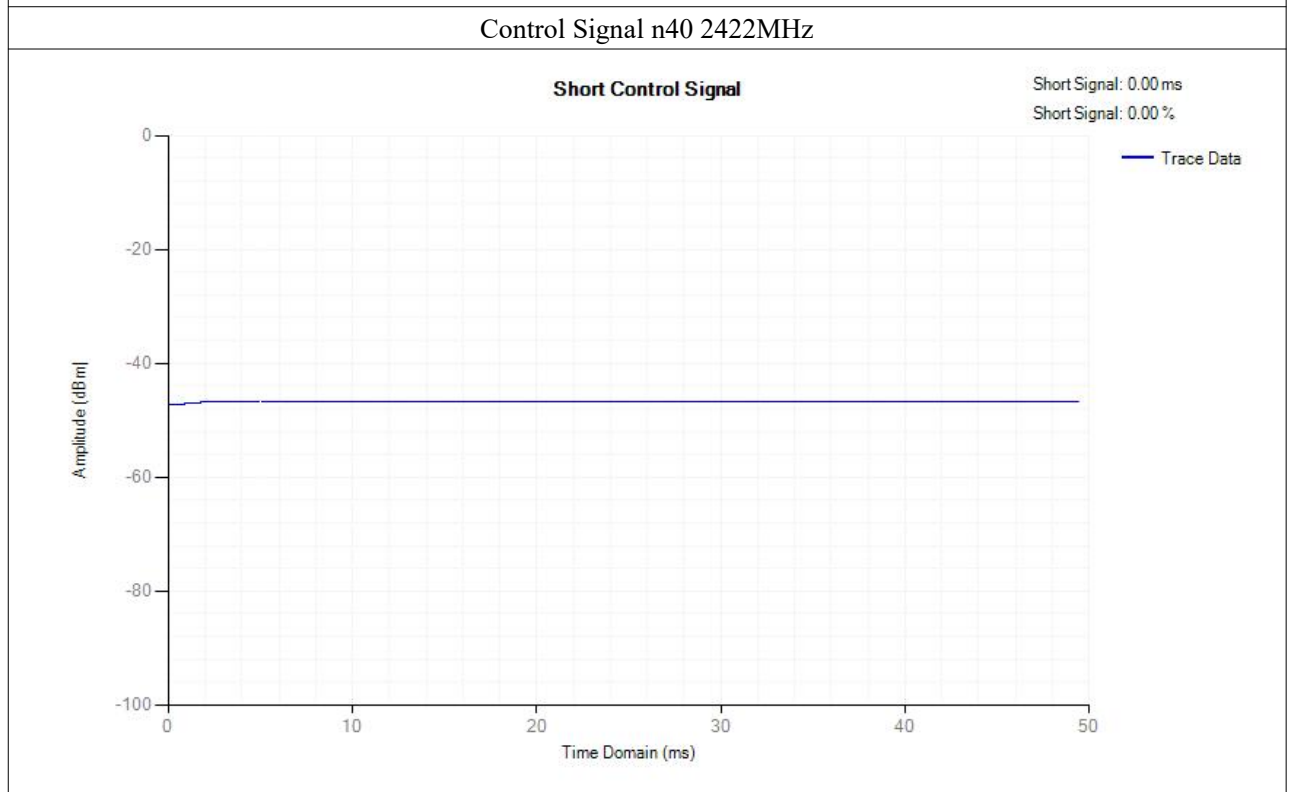
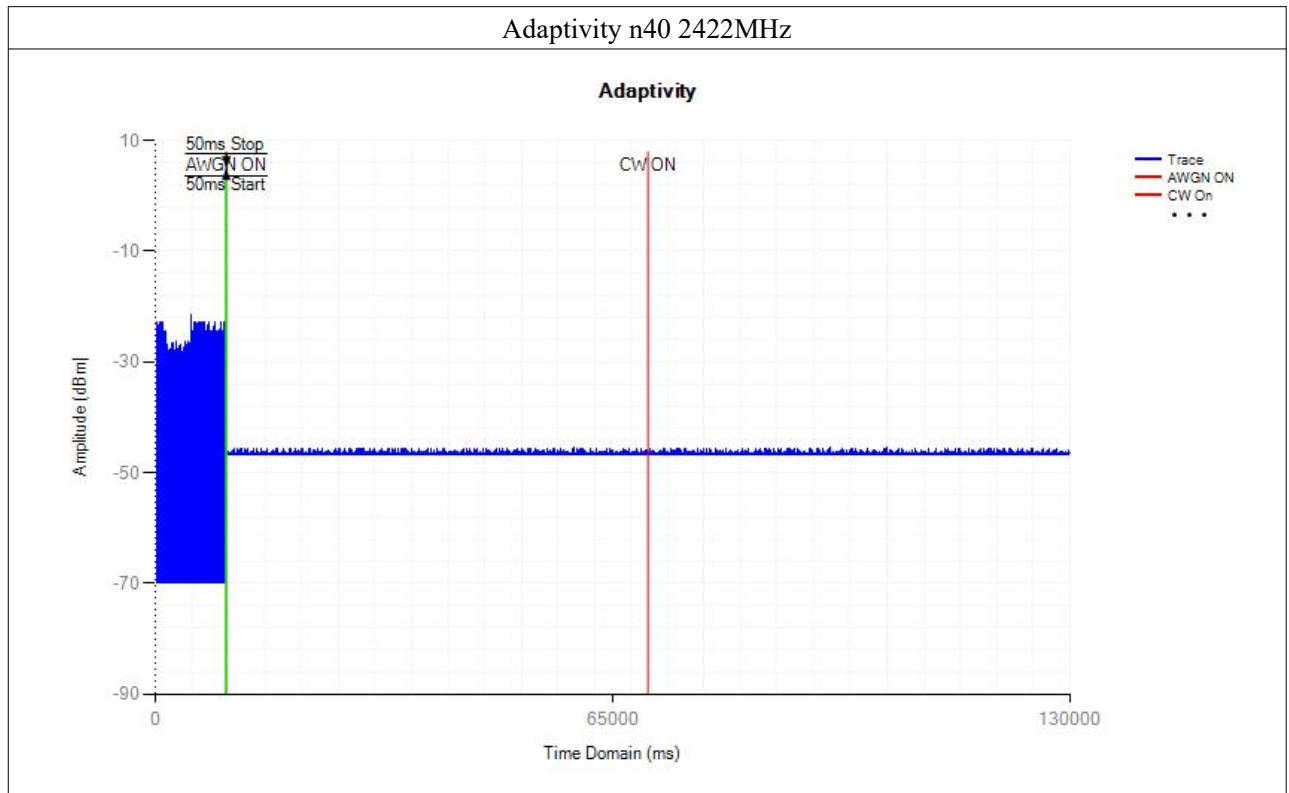

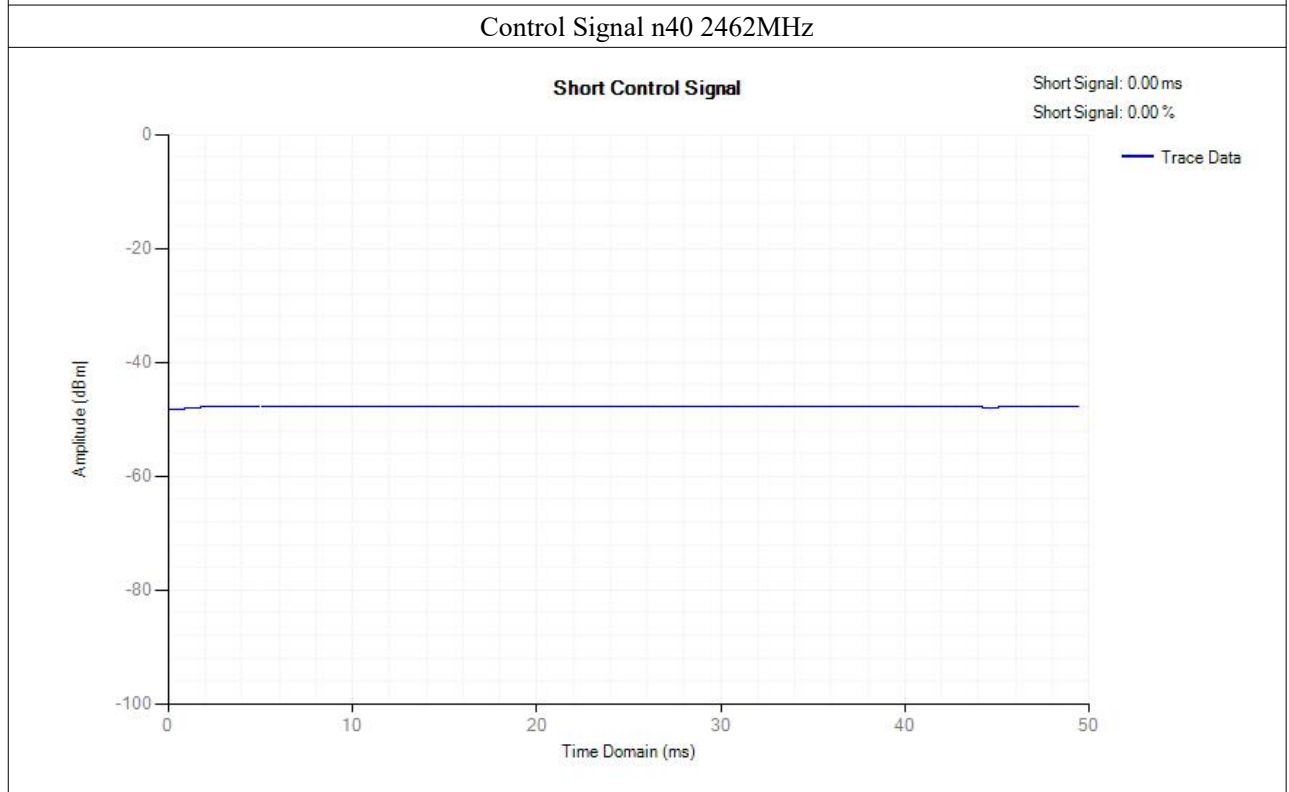
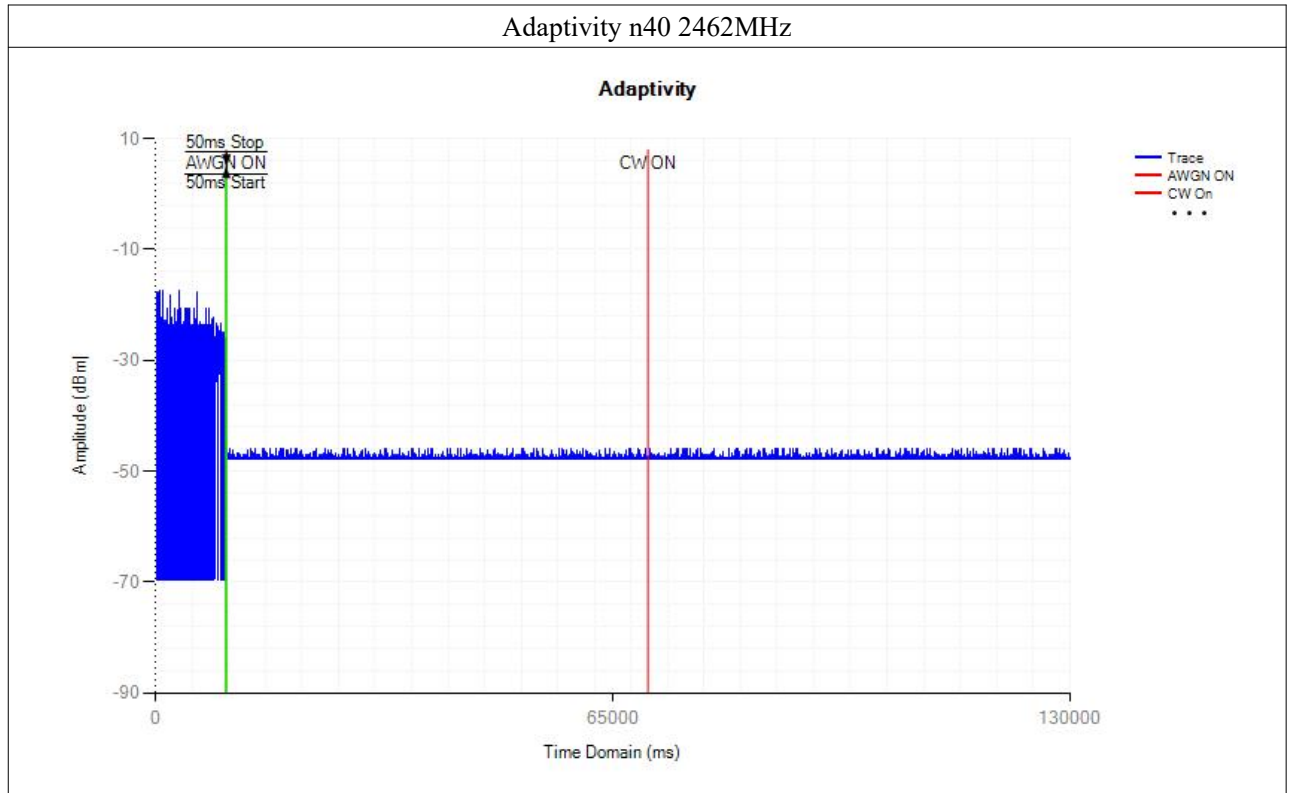

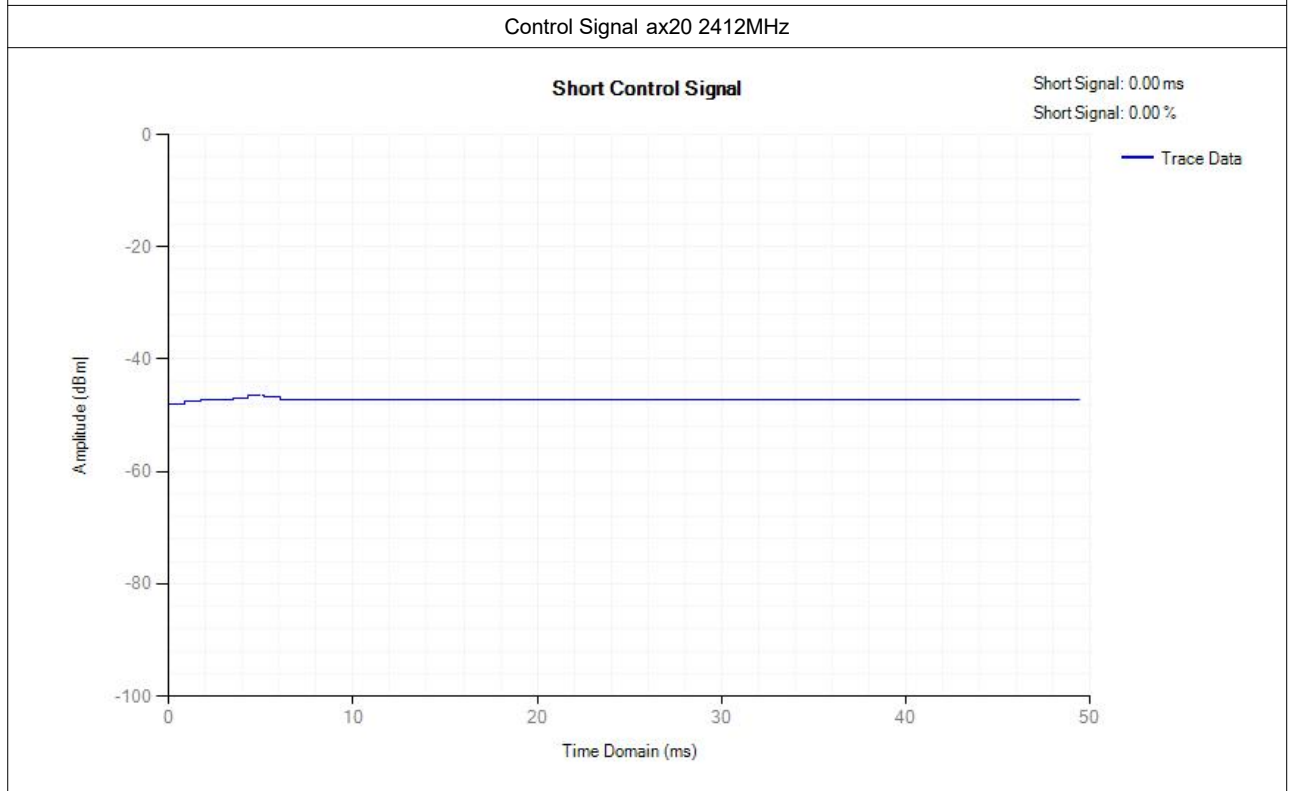
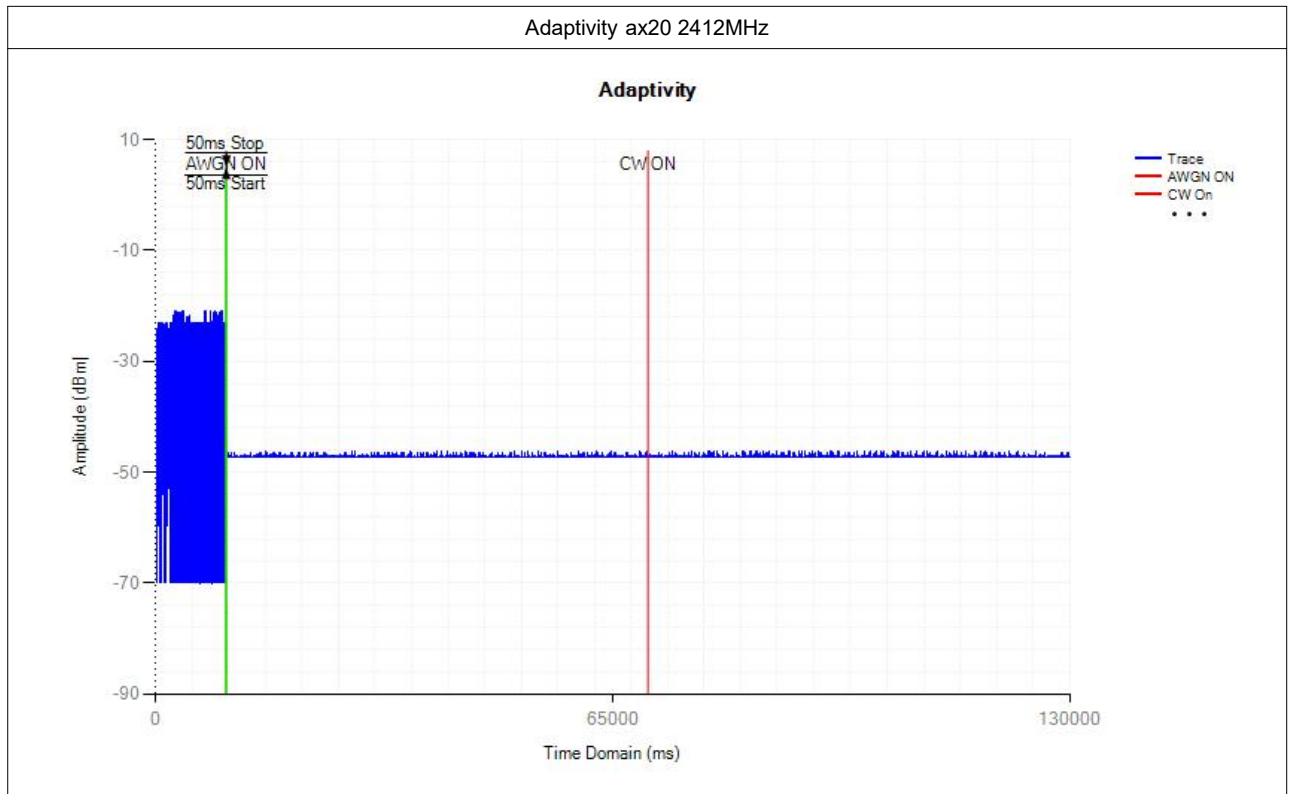

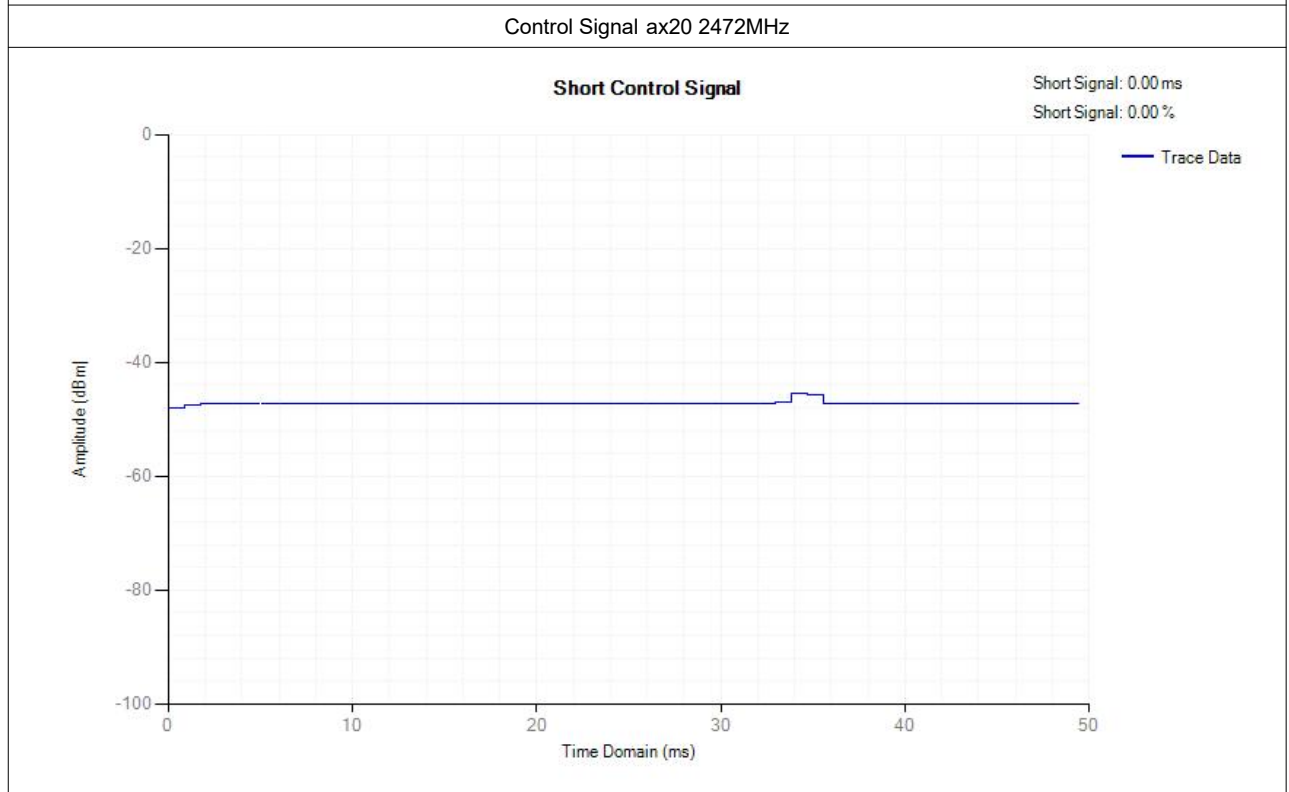
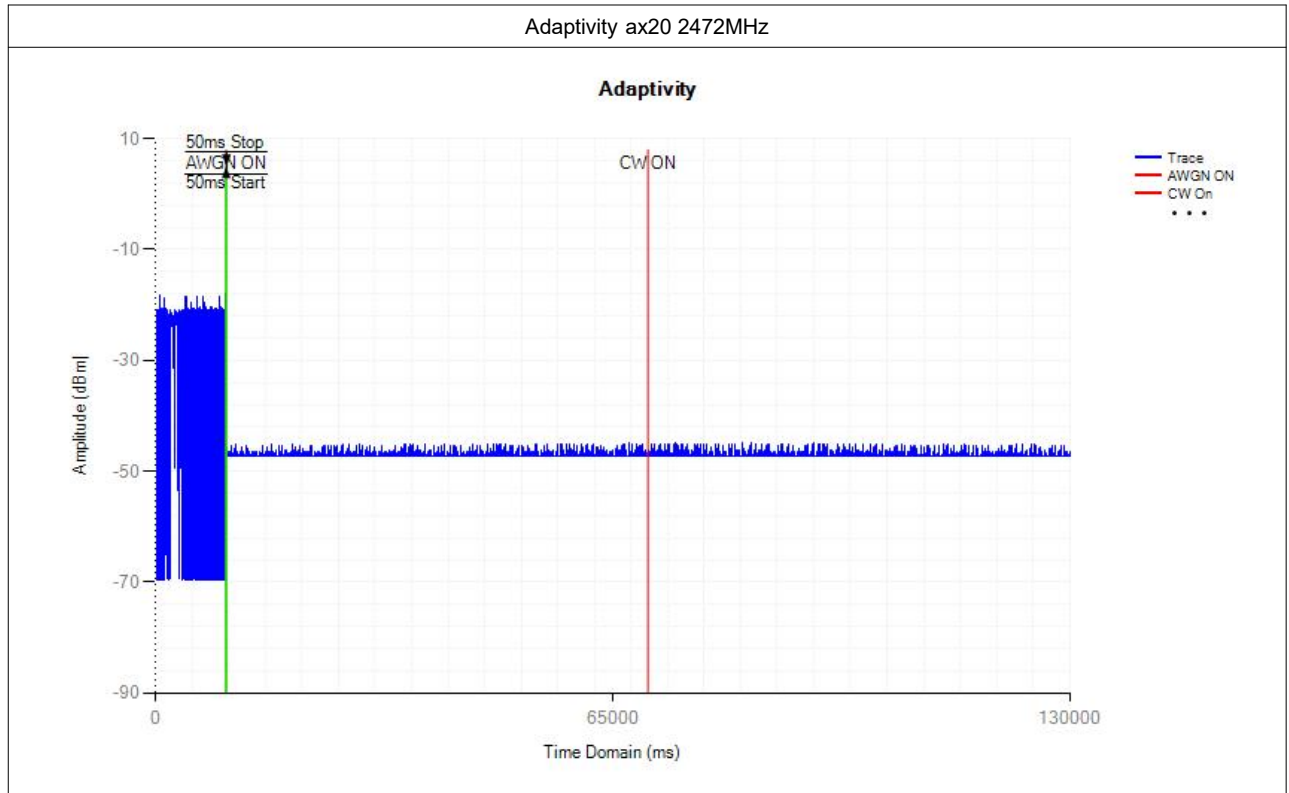

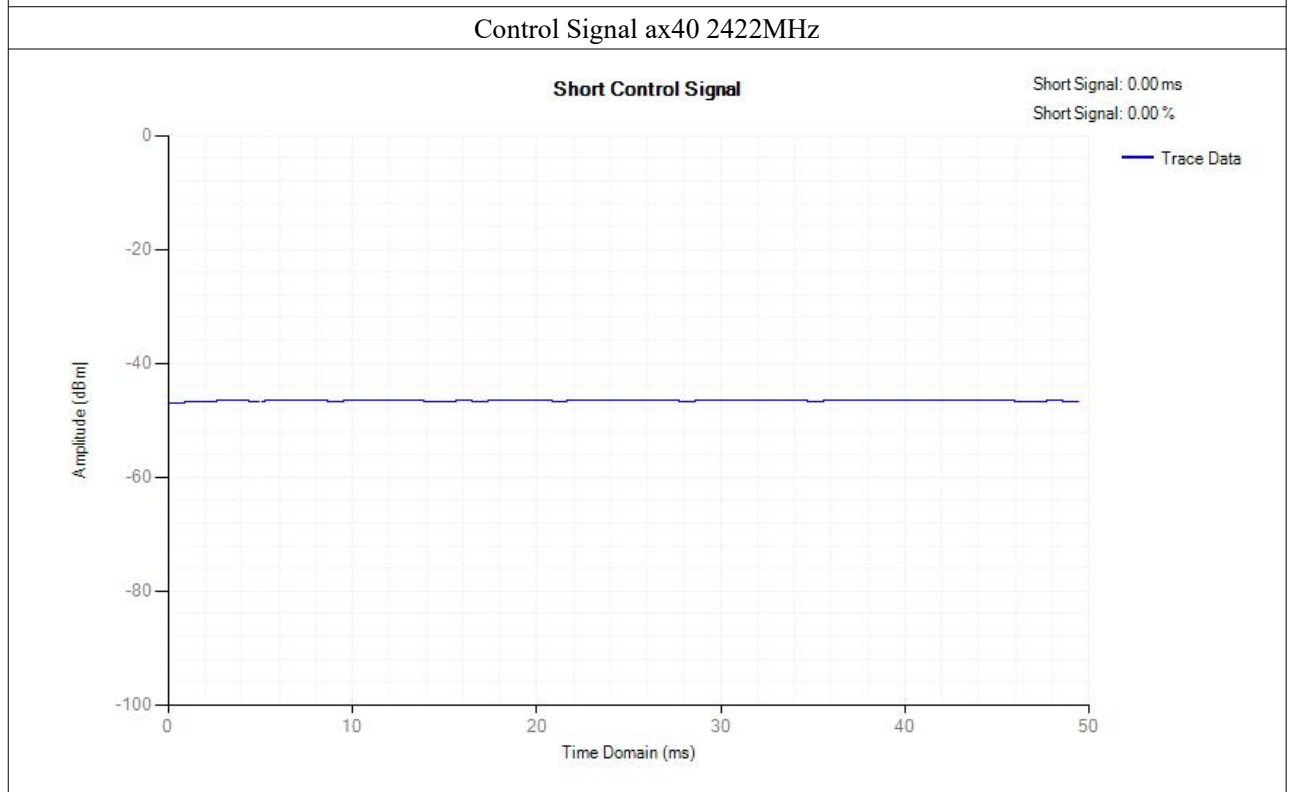
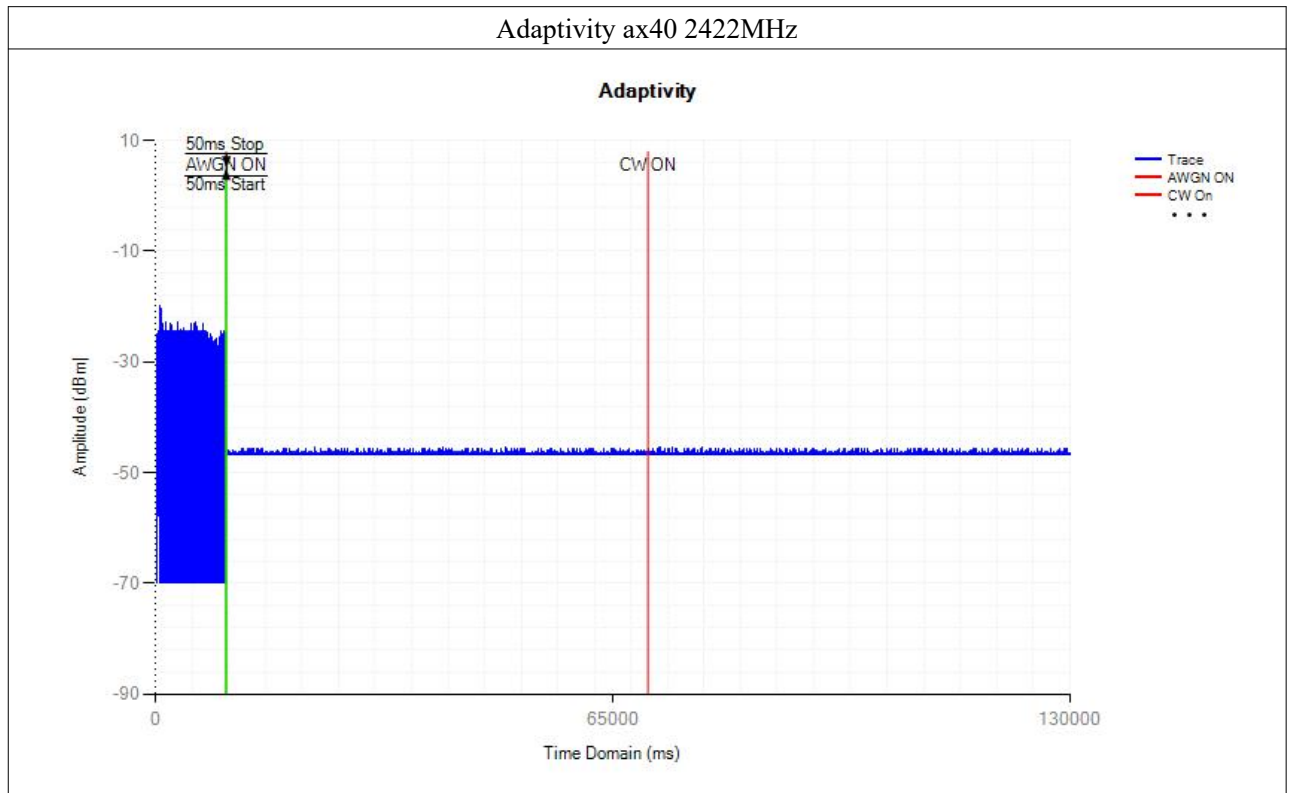

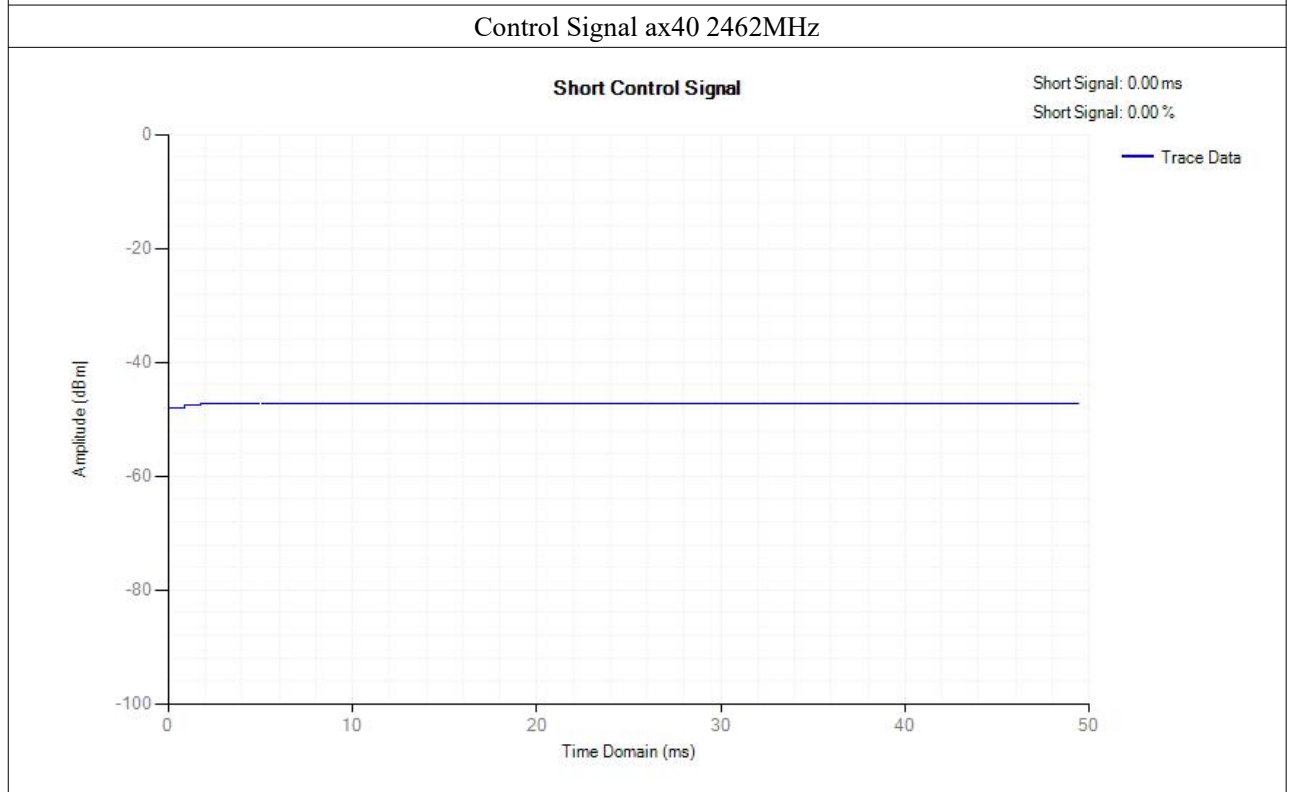
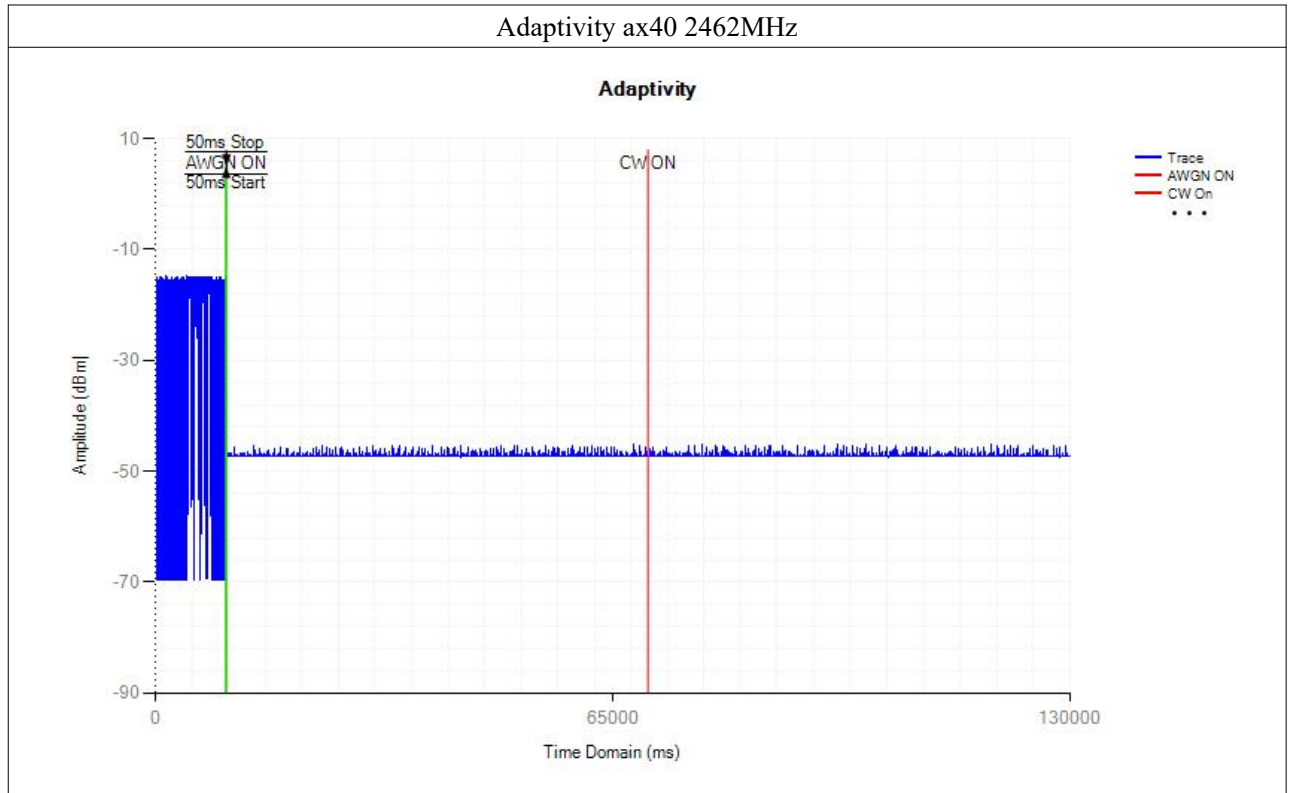

Adaptivity COT

Mode	Frequency (MHz)	Max COT (ms)	Limit COT (ms)	Min Idle Time (ms)	Limit Idle Time (ms)	Verdict
b	2412	1.525	<=13	0.128	>0.018	Pass
b	2472	2.638	<=13	0.128	>0.018	Pass
g	2412	0.563	<=13	0.06	>0.018	Pass
g	2472	0.595	<=13	0.06	>0.018	Pass
n20	2412	5.308	<=13	0.065	>0.018	Pass
n20	2472	0.61	<=13	0.065	>0.018	Pass
n40	2422	1.01	<=13	0.065	>0.018	Pass
n40	2462	1.263	<=13	0.087	>0.018	Pass
ax20	2412	0.763	<=13	0.113	>0.018	Pass
ax20	2472	0.528	<=13	0.065	>0.018	Pass
ax40	2422	0.365	<=13	0.077	>0.018	Pass
ax40	2462	2.66	<=13	0.09	>0.018	Pass

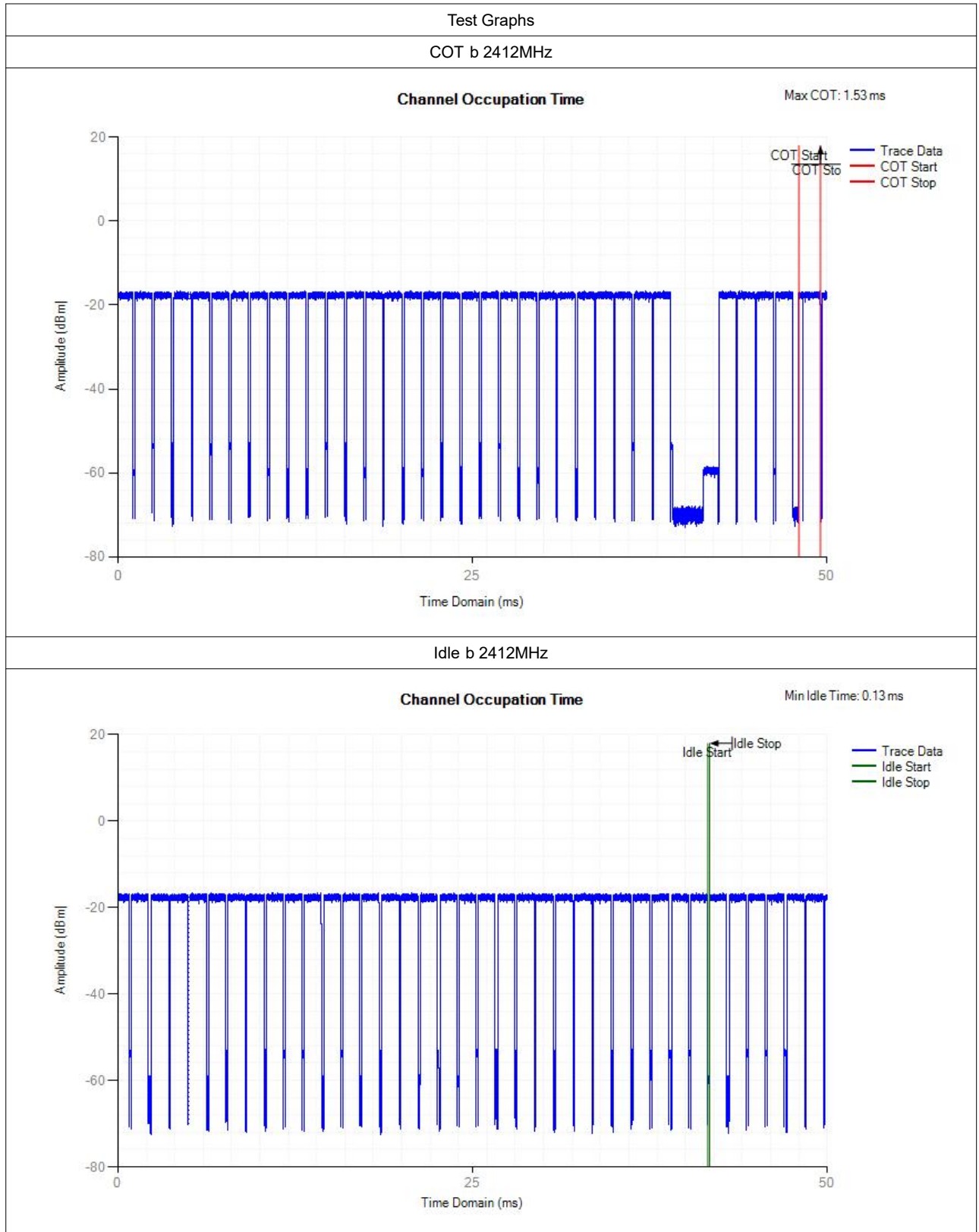

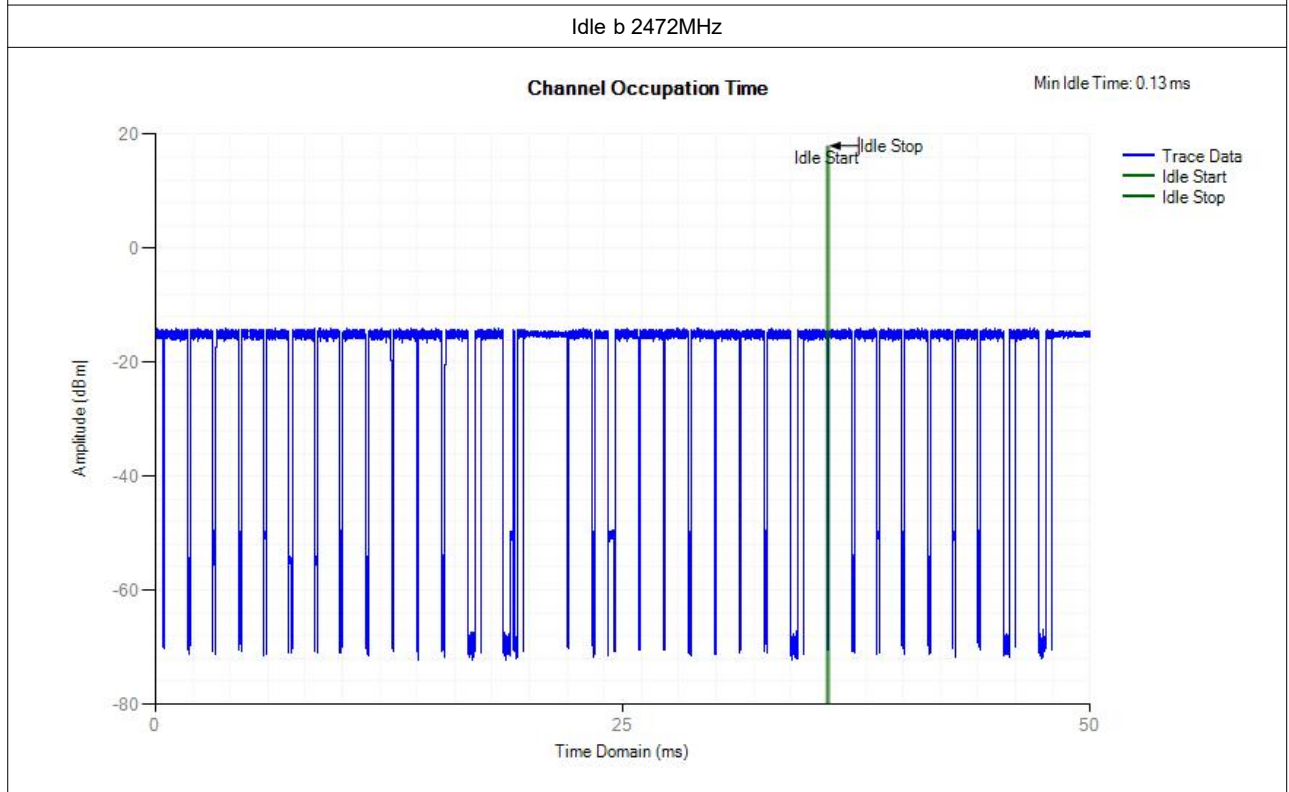
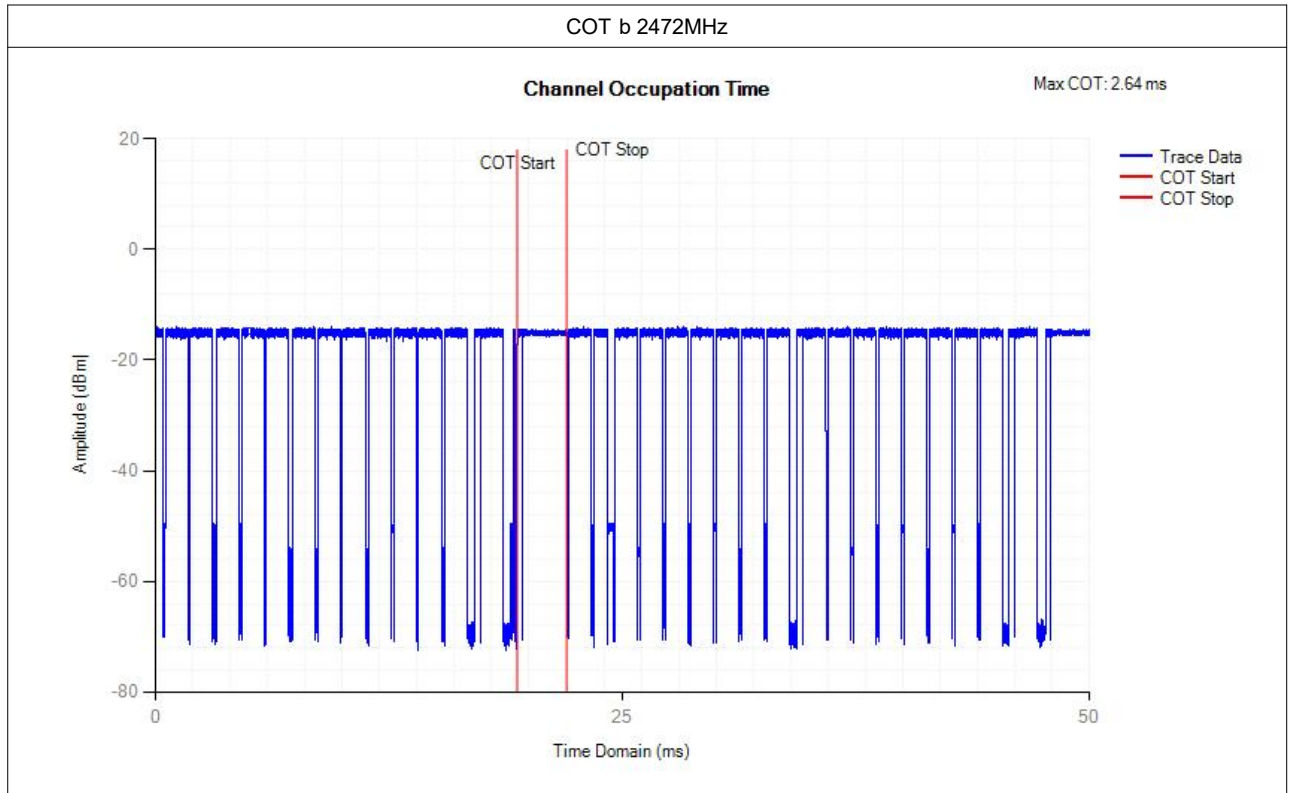

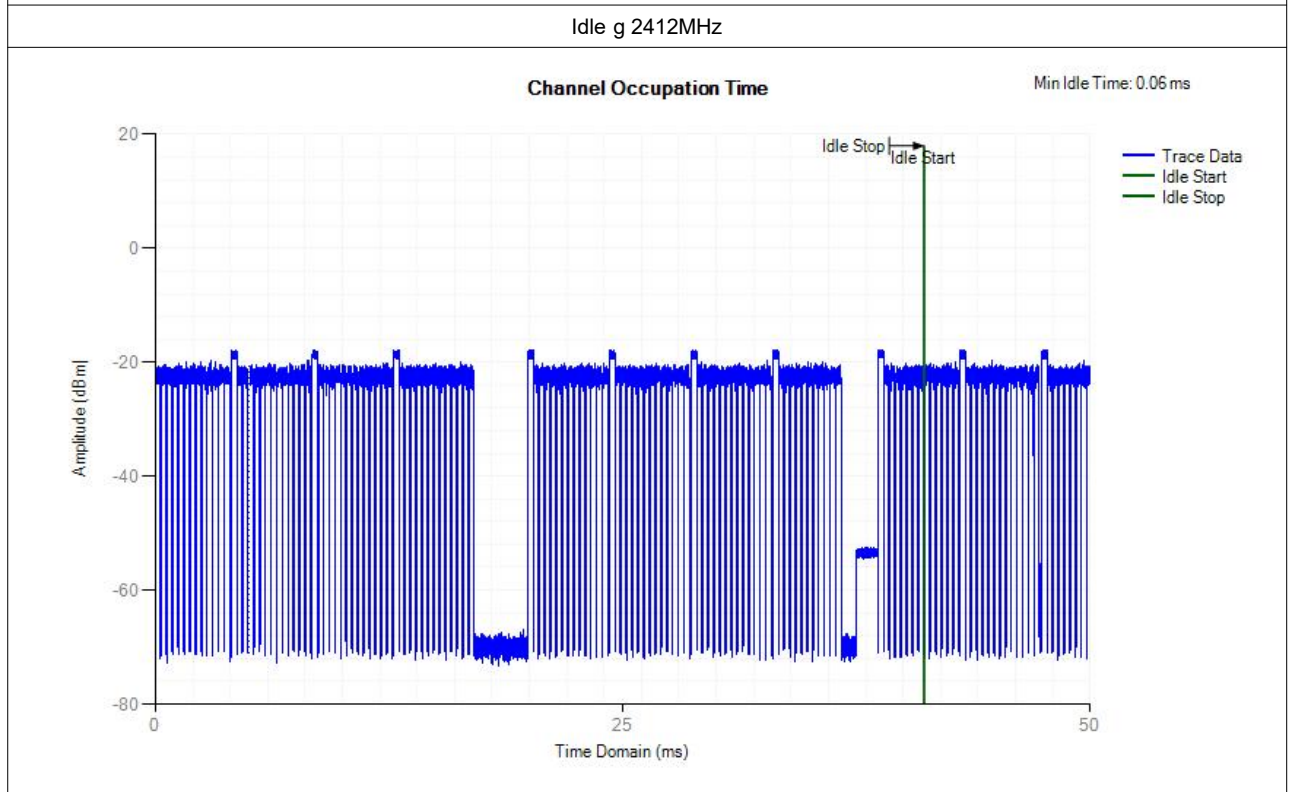
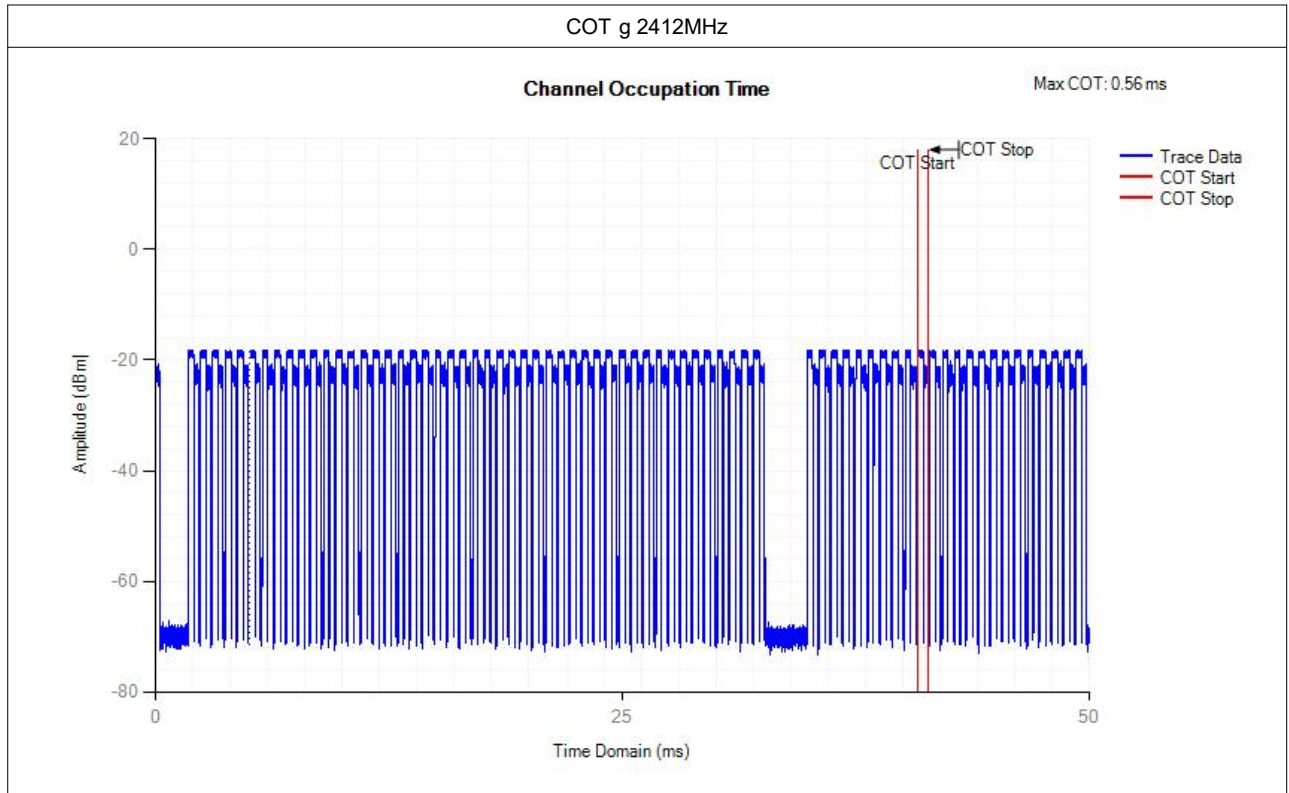

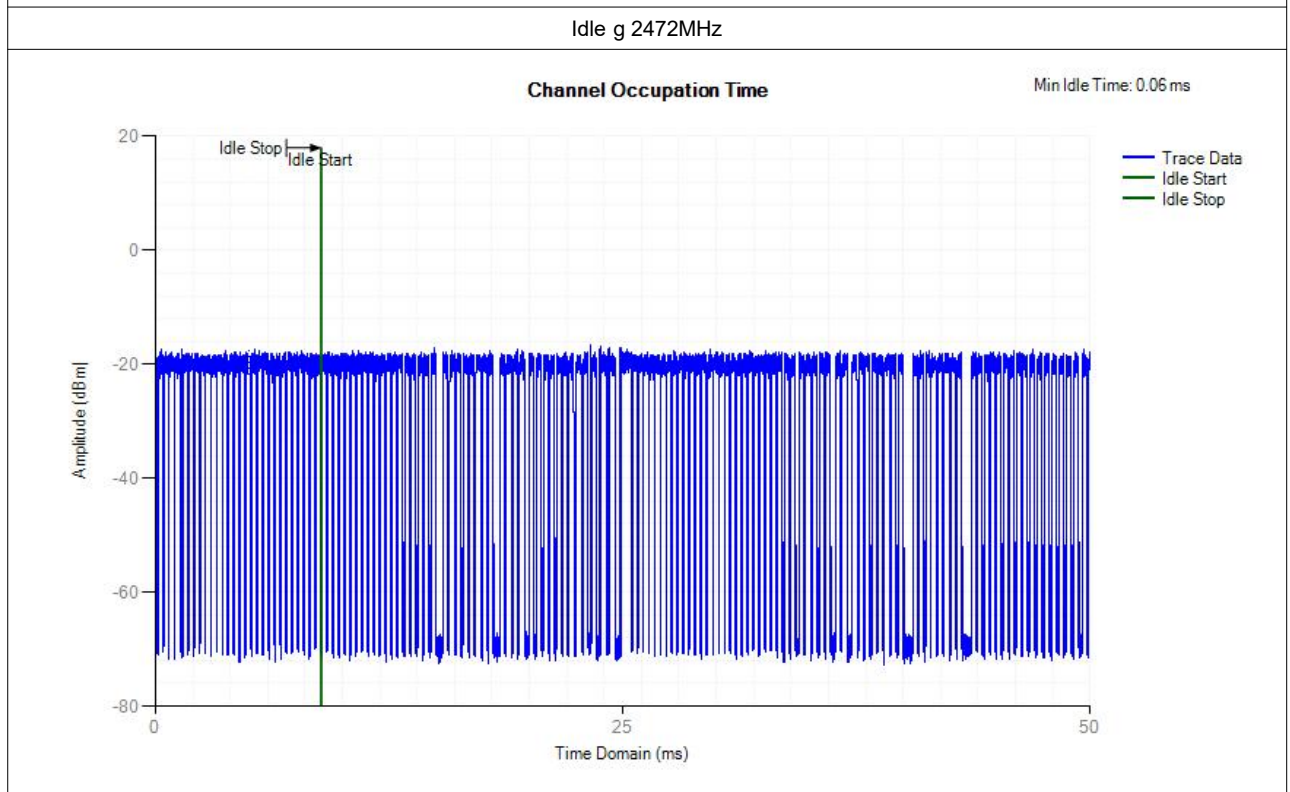
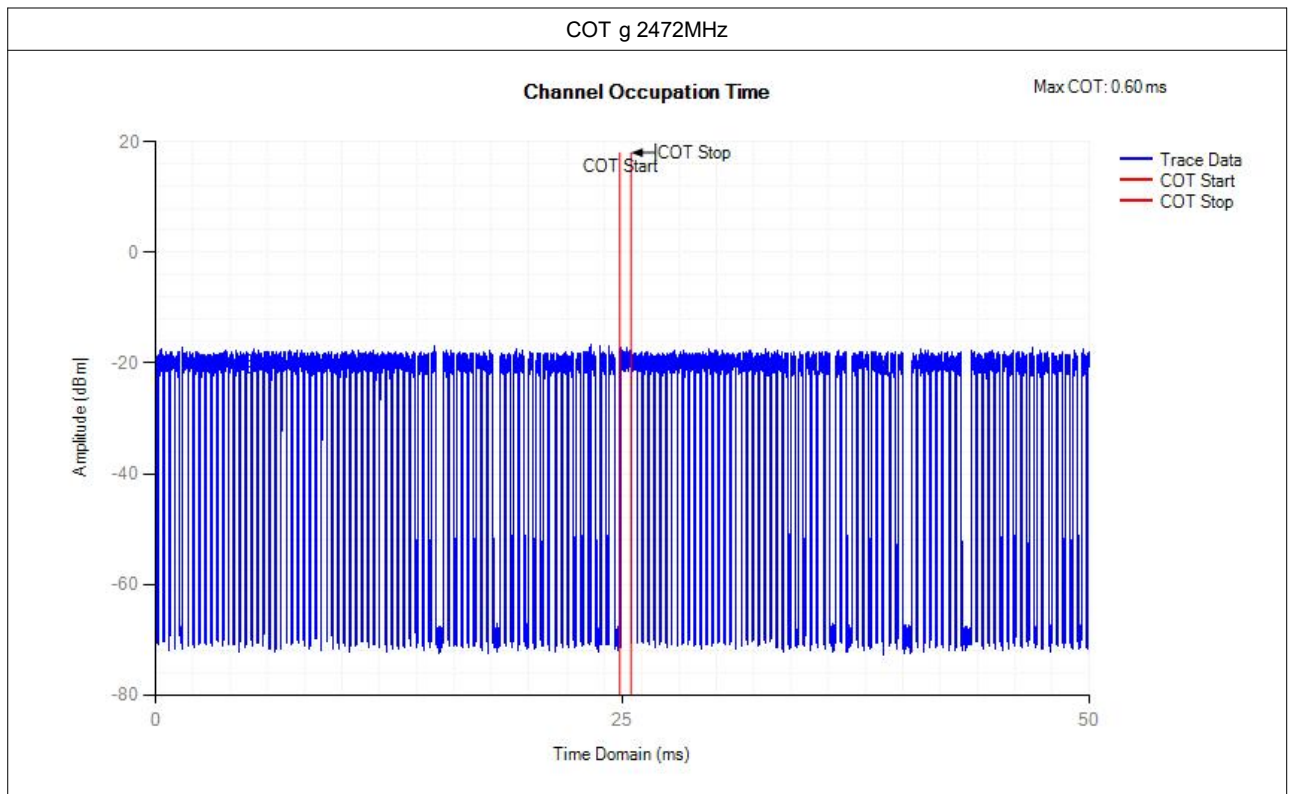

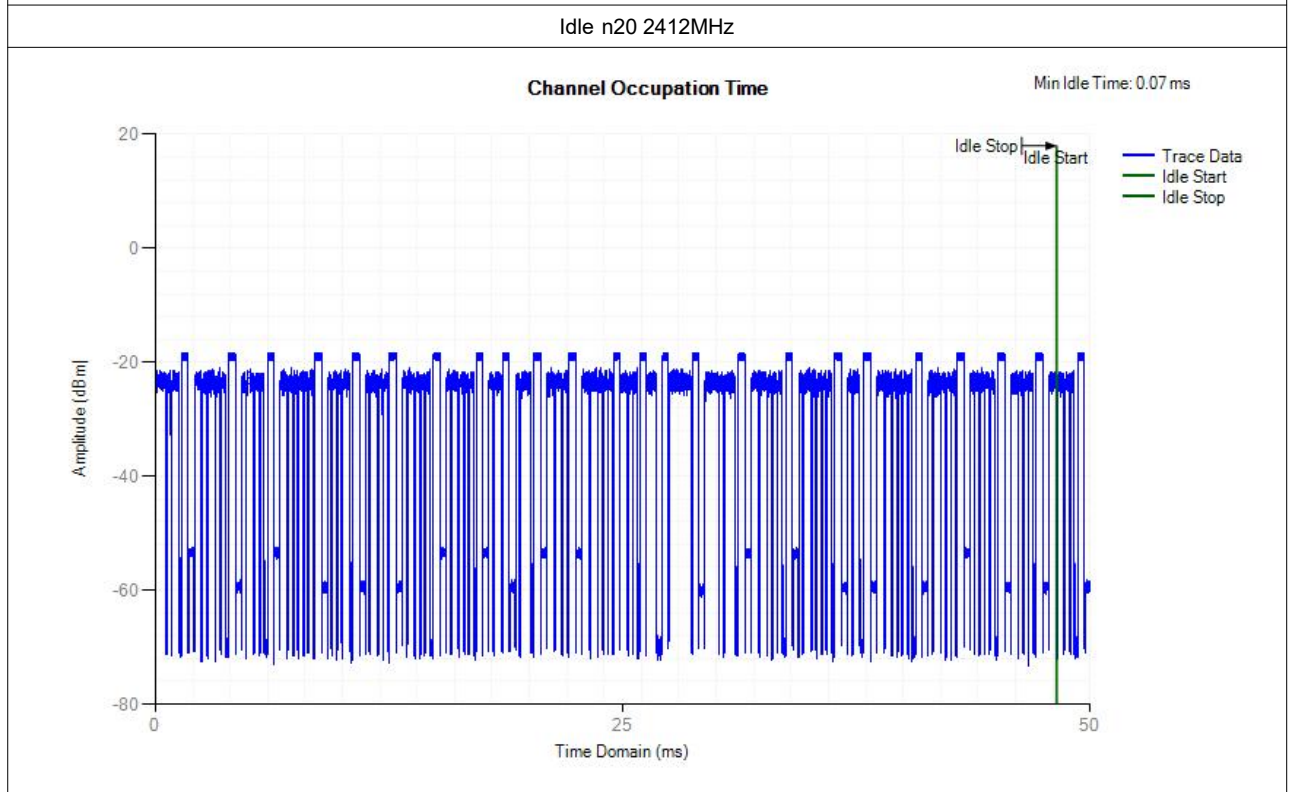
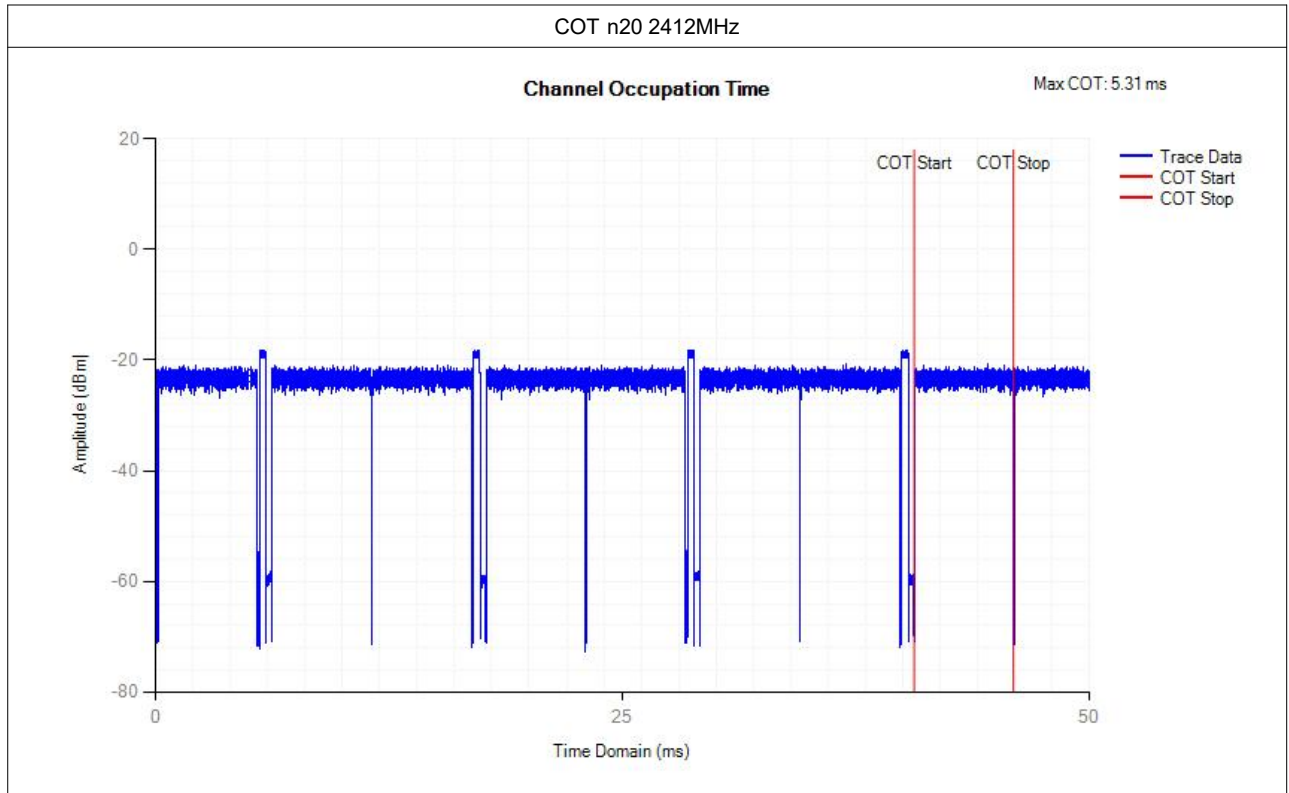

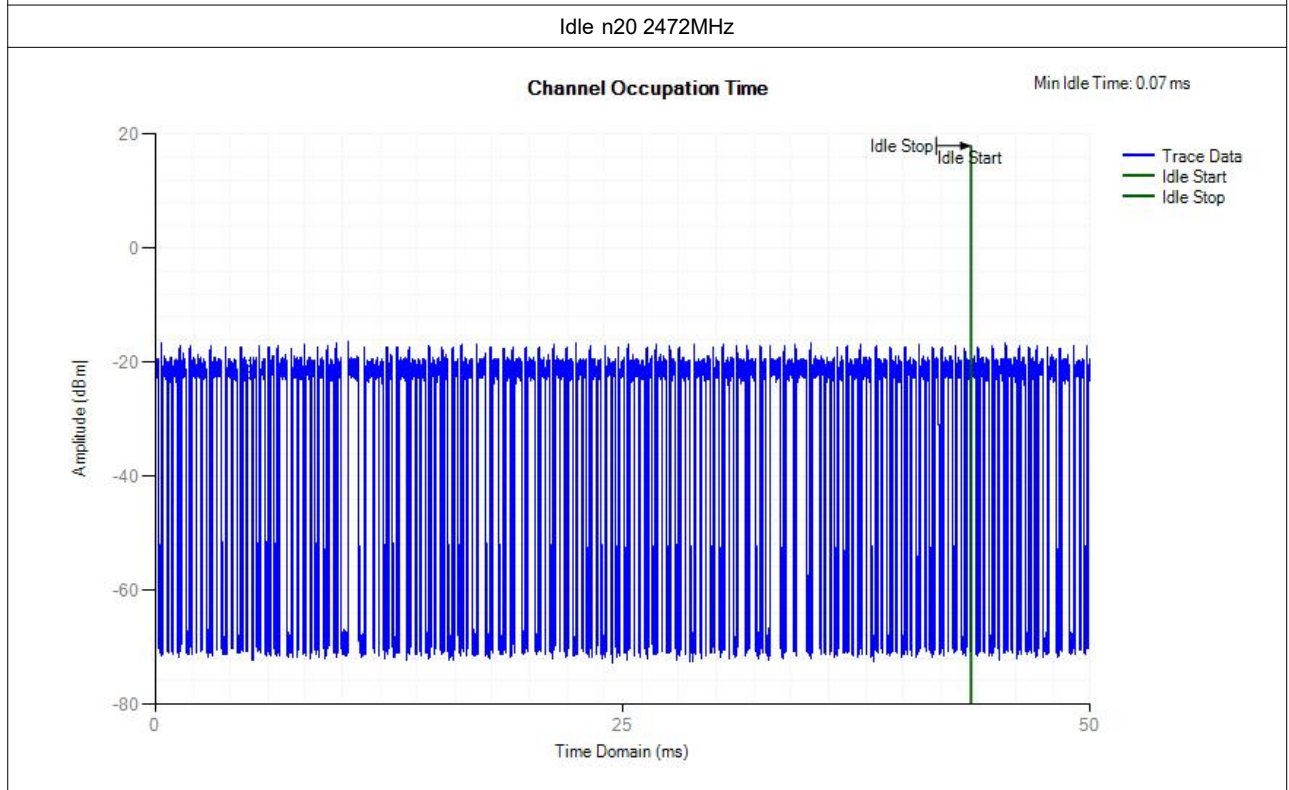
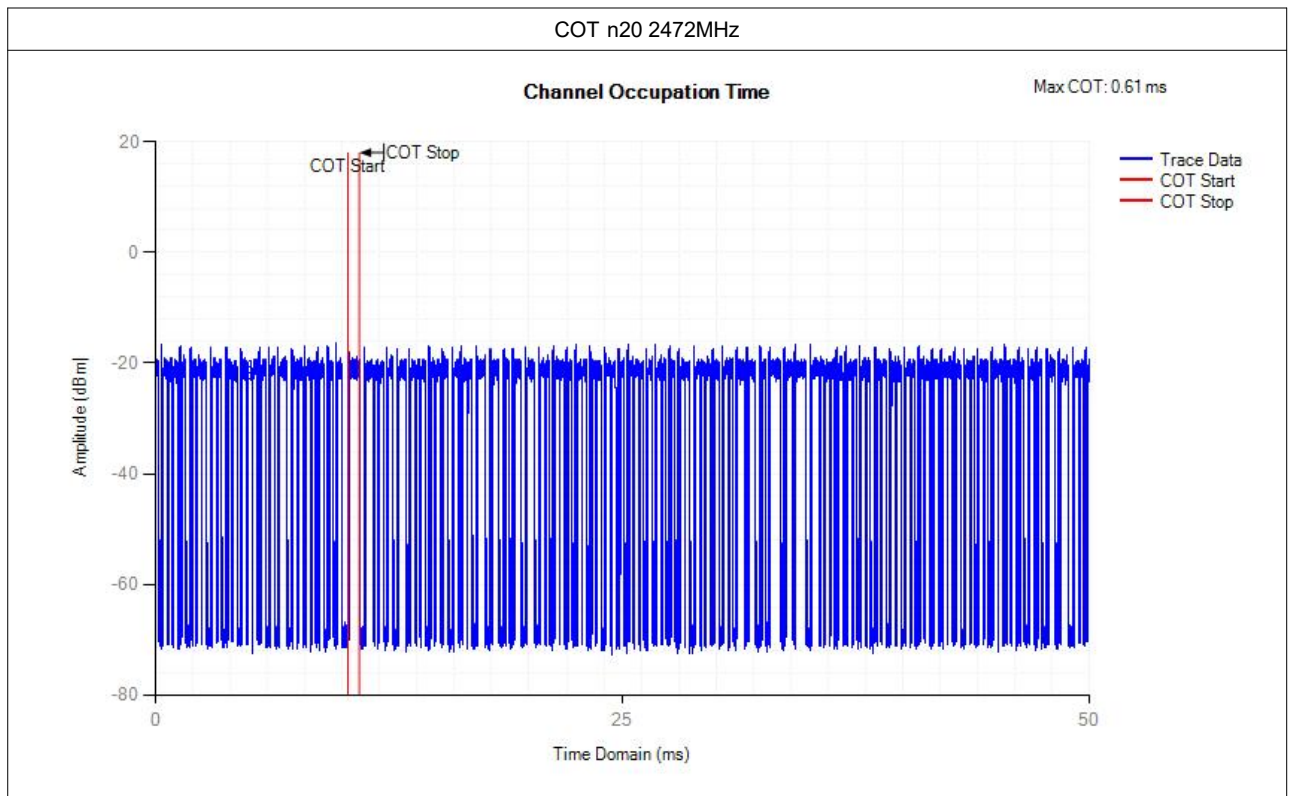

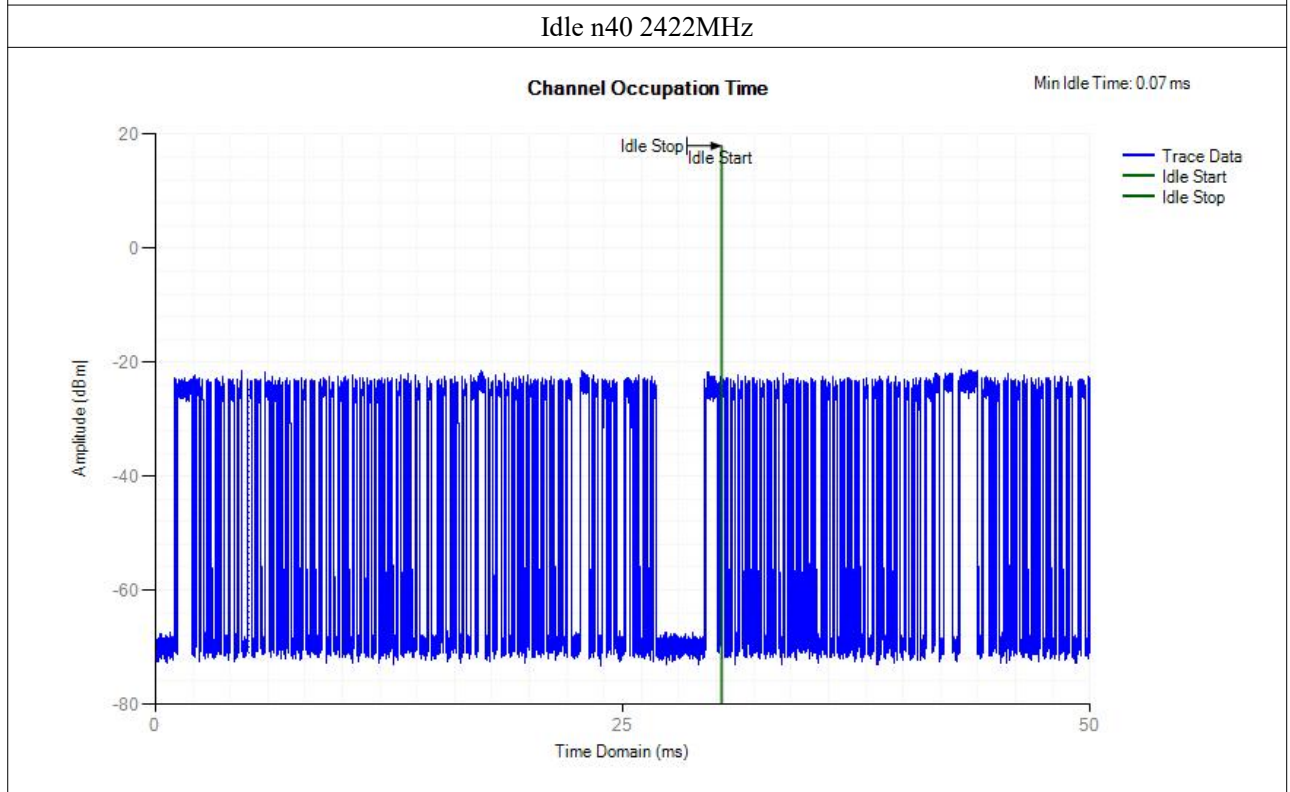
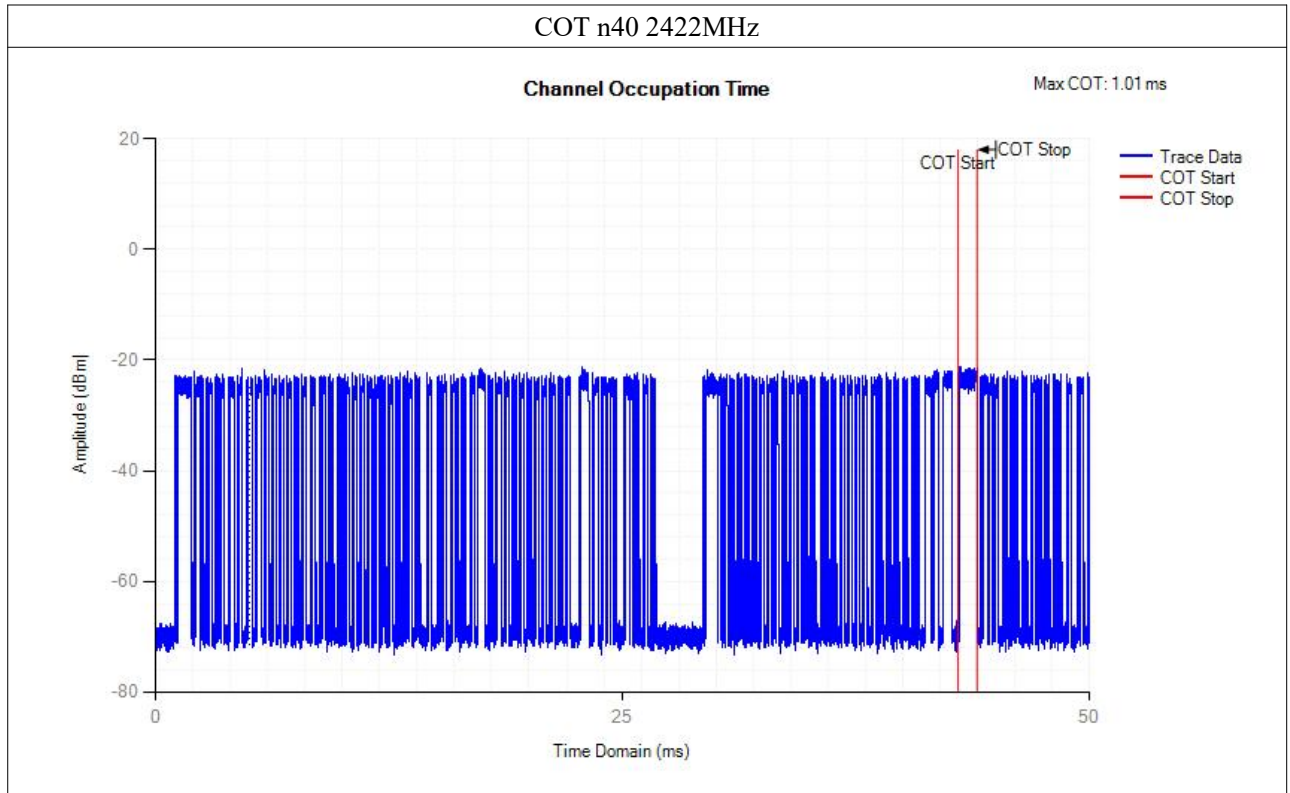

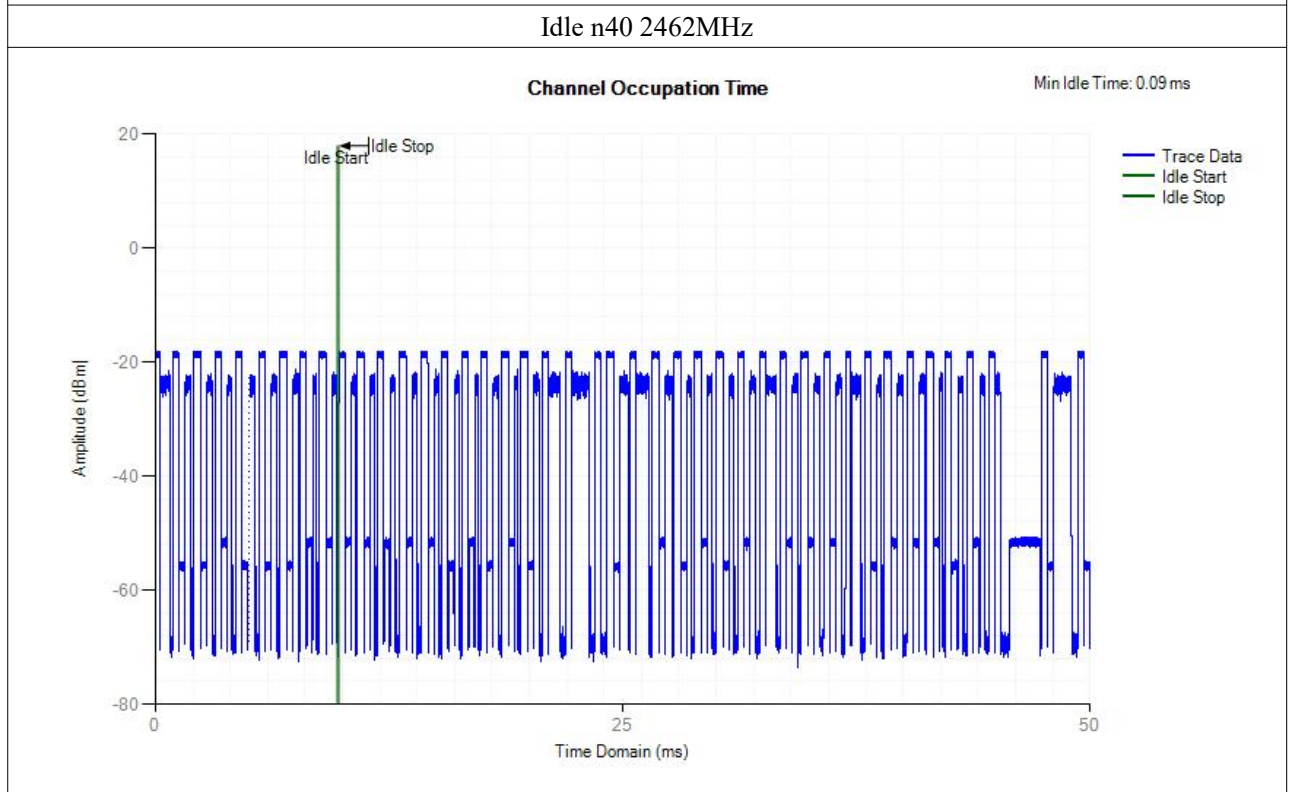
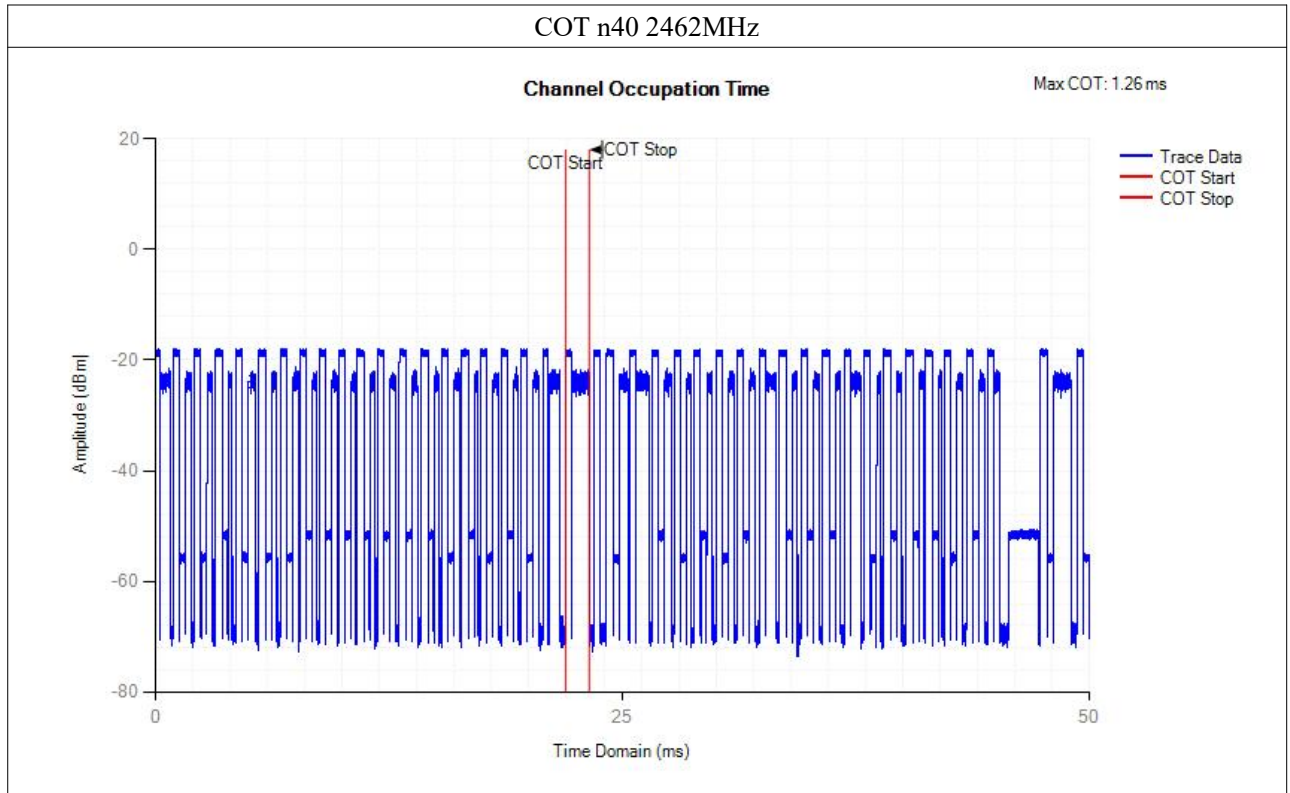

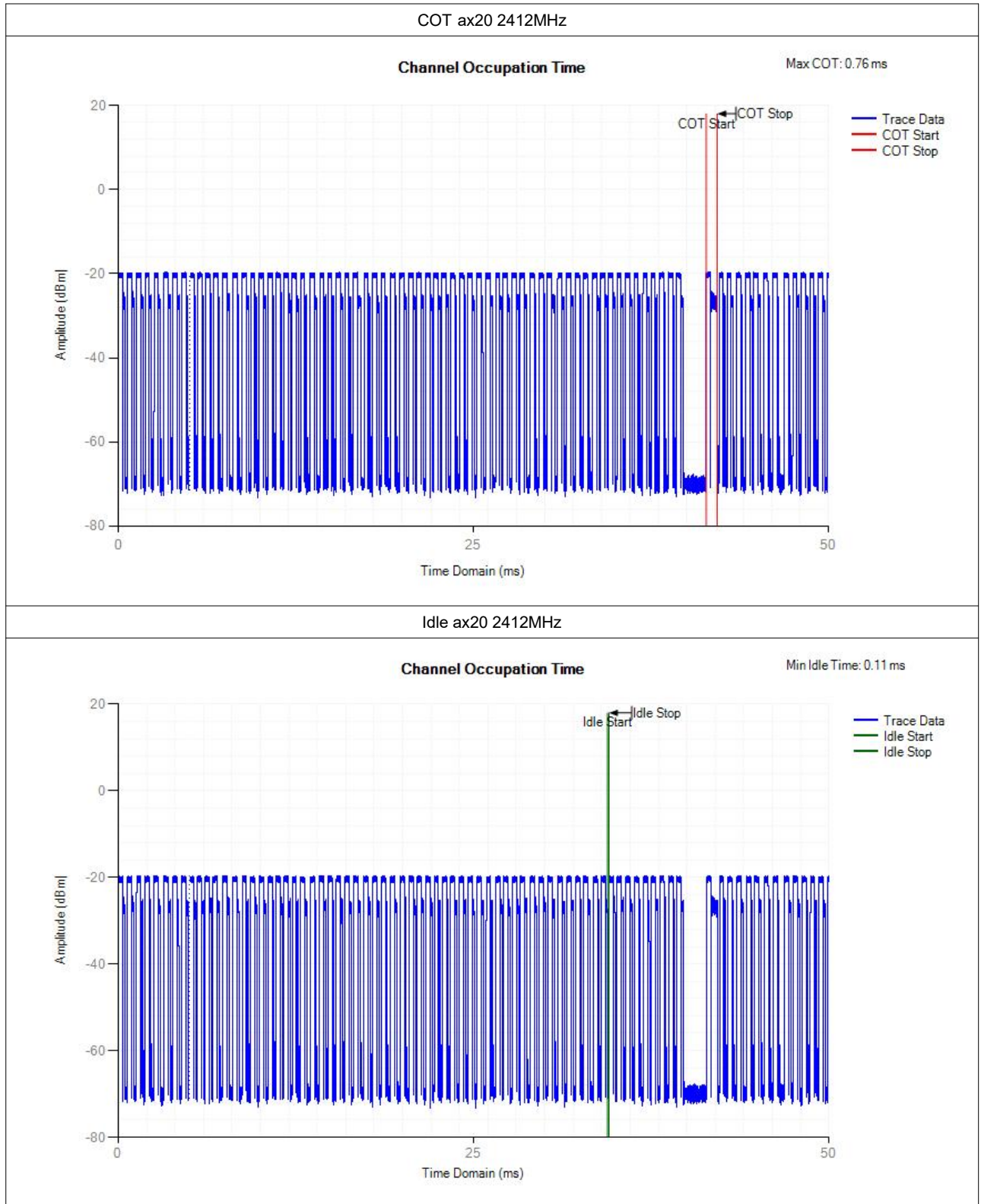

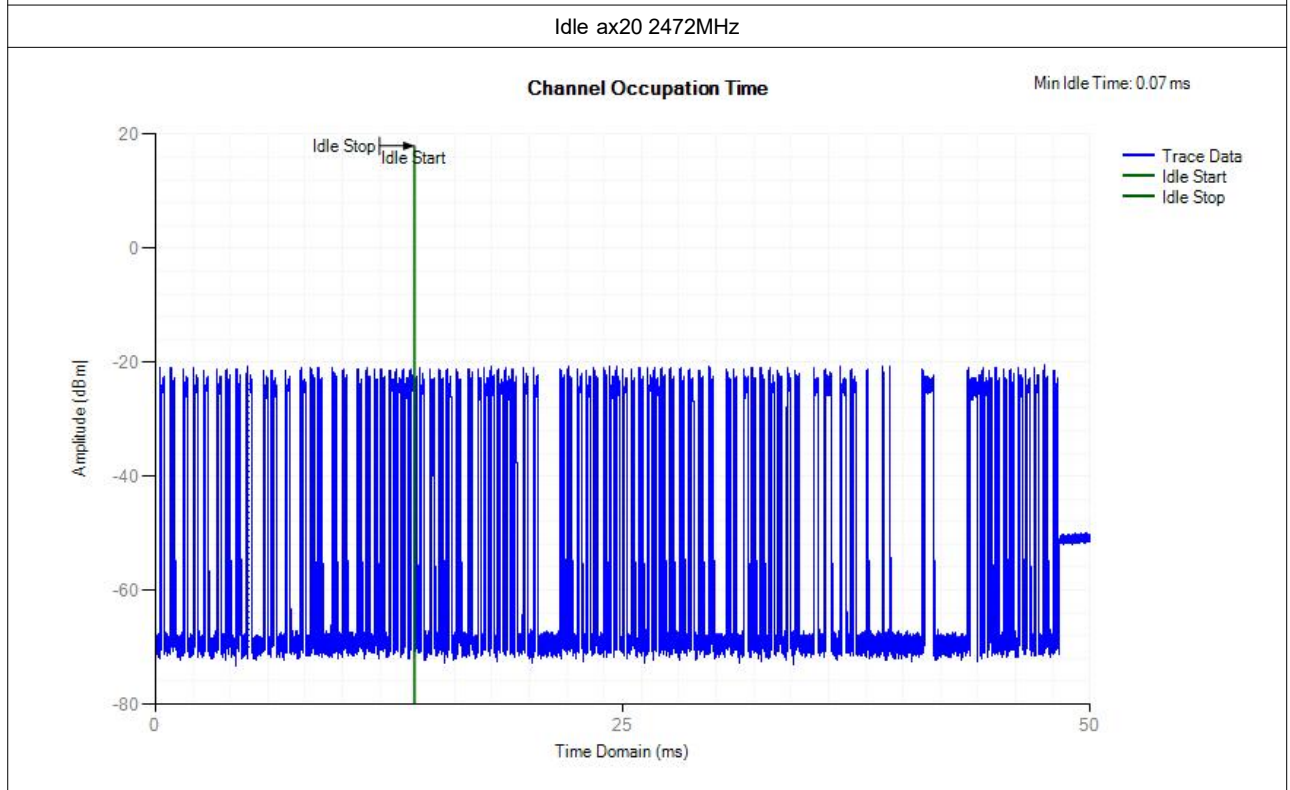
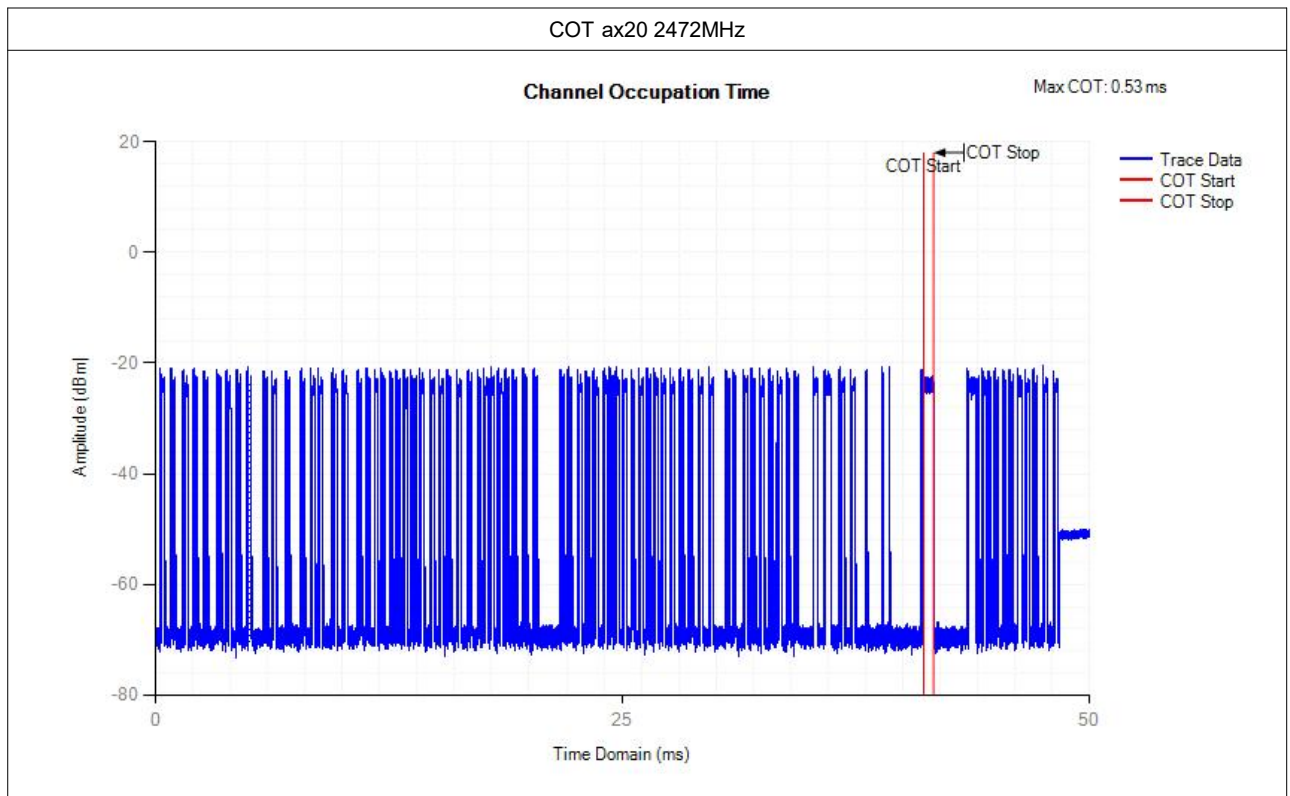

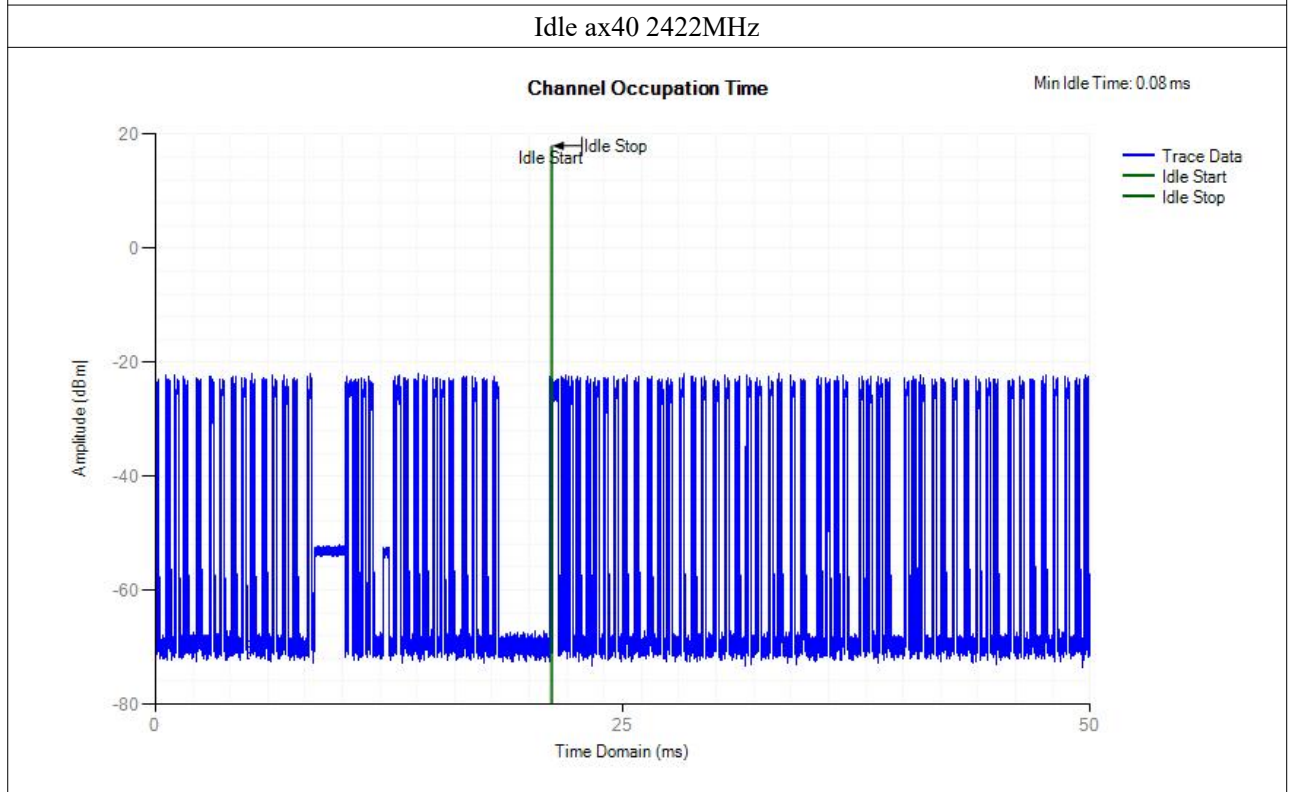
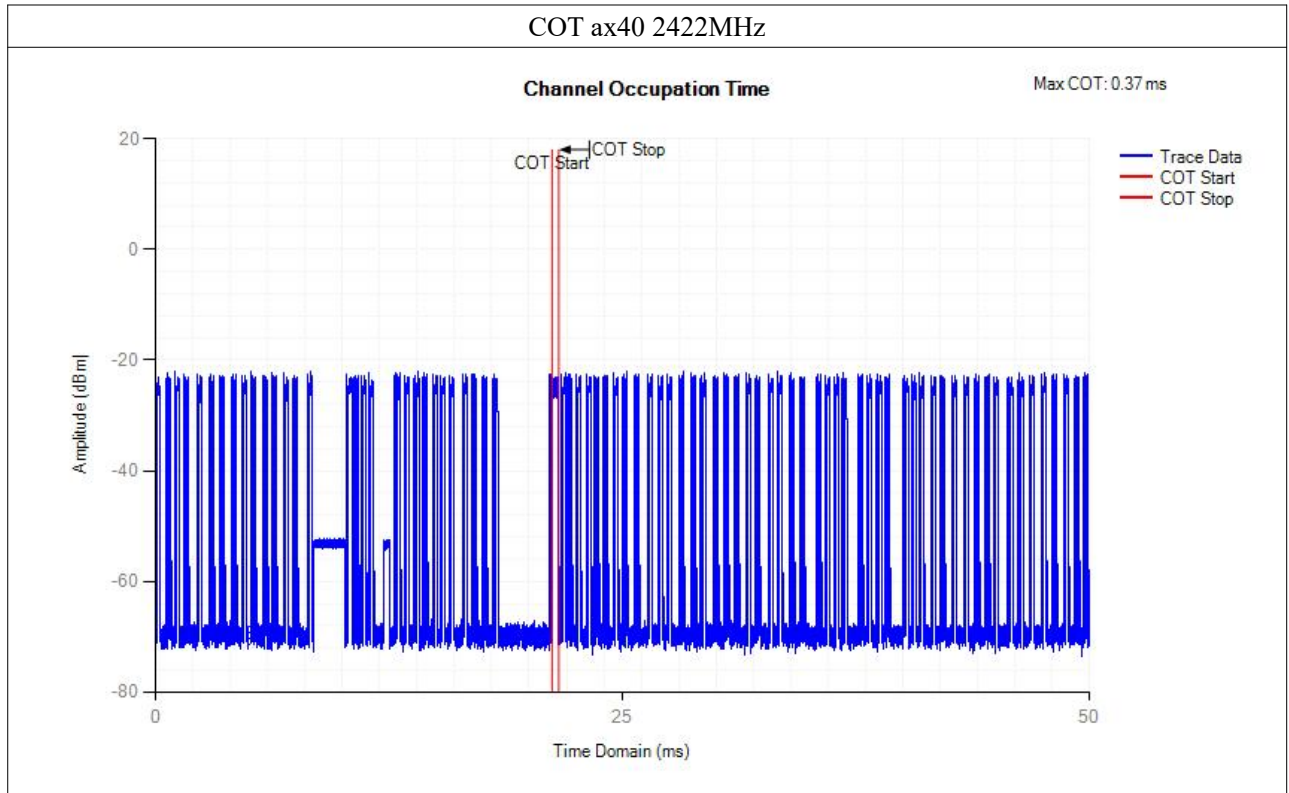

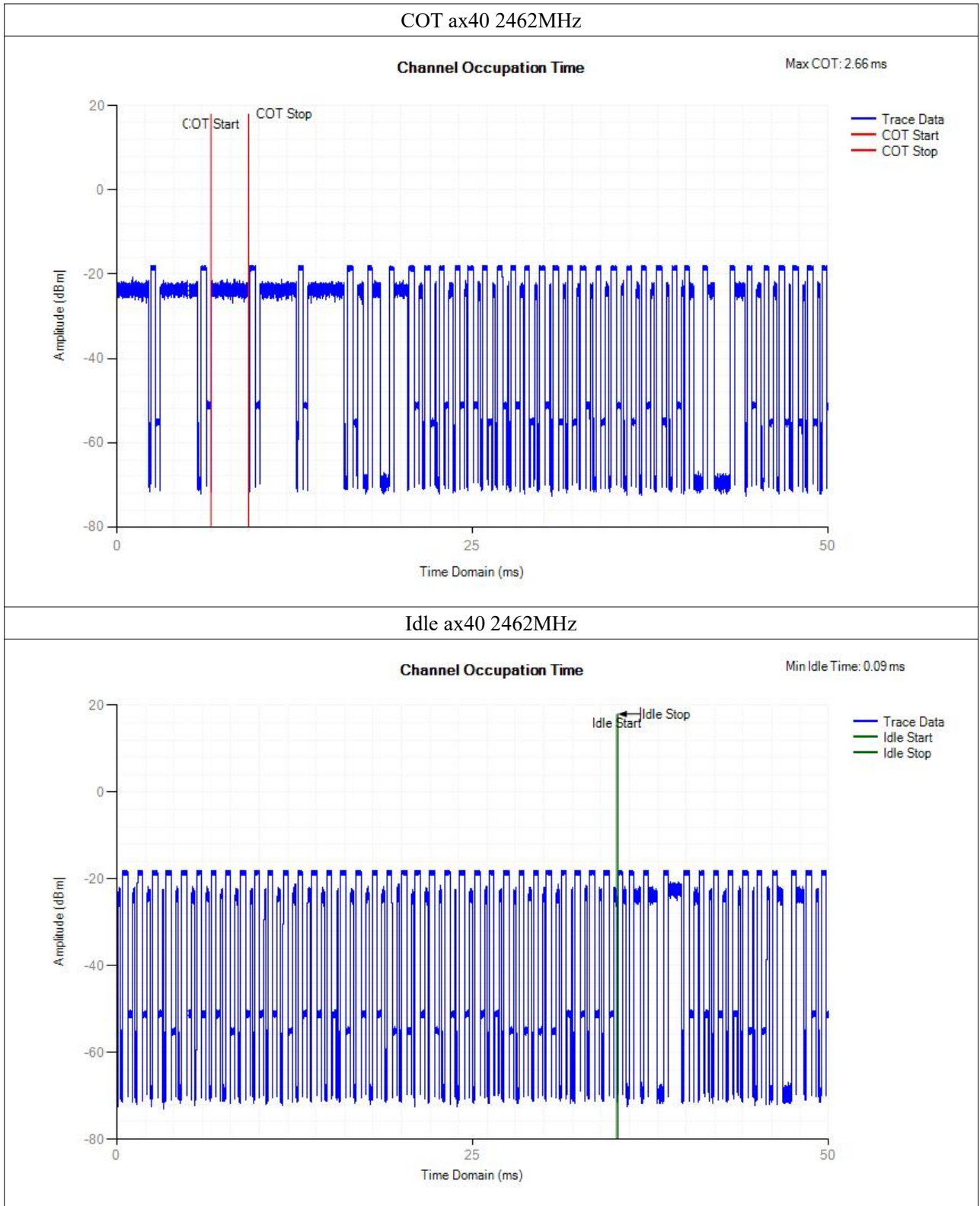

Note:

During the test, the signal observed on the channel being investigated is the Short Control Signalling Transmissions.

5.6 Transmitter unwanted emissions in the spurious domain

5.6.1 Limit(ETSI EN 300 328 V2.2.2 (2019-07) Clause 4.3.2.9.3)

TRANSMITTER UNWANTED EMISSIONS IN THE SPURIOUS DOMAIN		
Frequency Range	Maximum Power Limit (E.R.P.(≤1 GHz) E.I.R.P.(> 1 GHz))	Bandwidth
30 MHz to 47 MHz	-36dBm	100 kHz
47 MHz to 74 MHz	-54dBm	100 kHz
74 MHz to 87.5 MHz	-36dBm	100 kHz
87.5 MHz to 118 MHz	-54dBm	100 kHz
118 MHz to 174 MHz	-36dBm	100 kHz
174 MHz to 230 MHz	-54dBm	100 kHz
230 MHz to 470 MHz	-36dBm	100 kHz
470 MHz to 694 MHz	-54dBm	100 kHz
694MHz to 1 GHz	-36dBm	100 kHz
1 GHz ~ 12.75 GHz	-30dBm	1 MHz

5.6.2 Test procedure

Refer to ETSI EN 300 328 V2.2.2 (2019-07) Clause 5.4.9

Measurement	
<input checked="" type="checkbox"/> Conducted measurement	<input checked="" type="checkbox"/> Radiated measurement

The setting of the Spectrum Analyzer

RBW	100K(<1GHz) / 1M(> 1GHz)
VBW	300K(<1GHz) / 3M(> 1GHz)

5.6.3 TEST SETUP

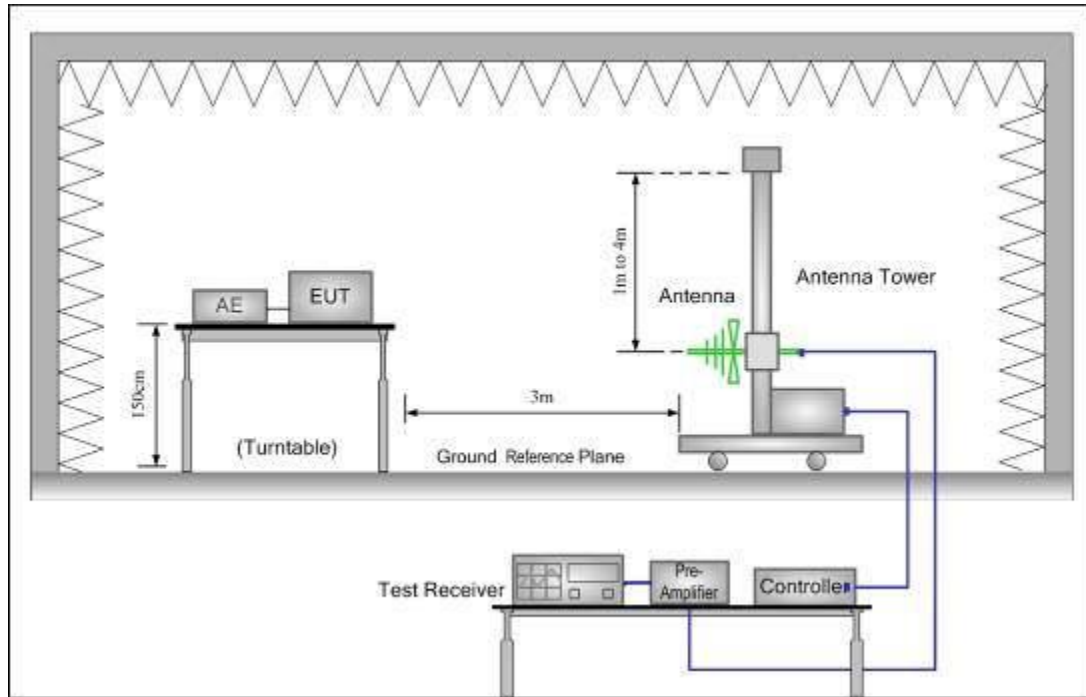

Figure 1. 30MHz to 1GHz

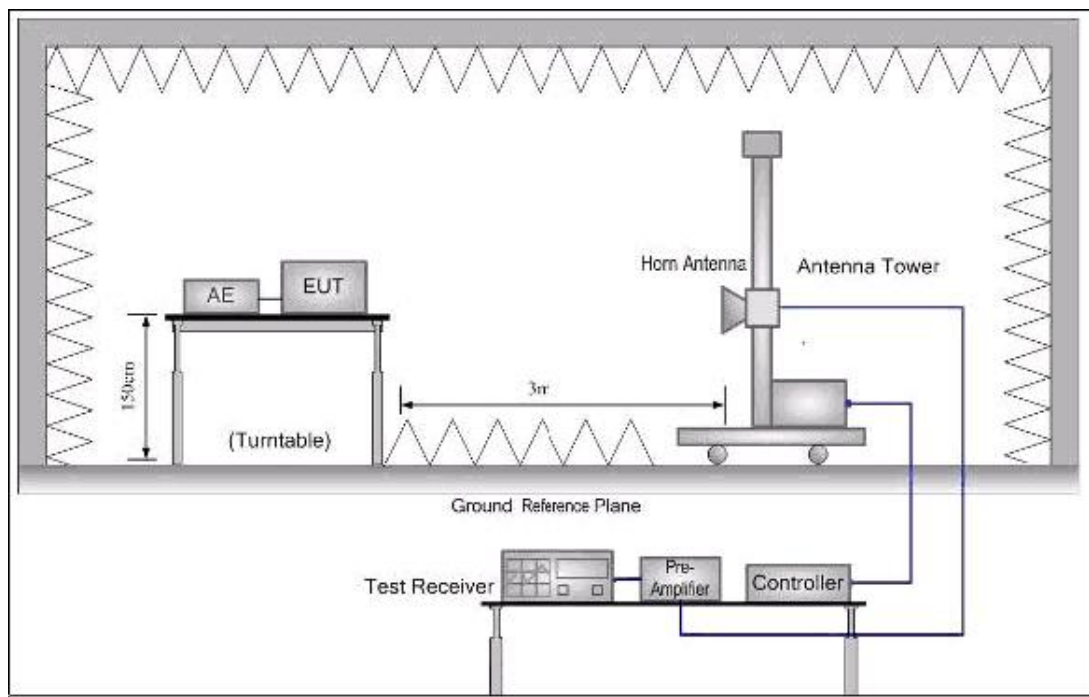

Figure 2. Above 1GHz

5.6.4 Radiated Test result

802.11b lowest (2412 MHz)

below 1 GHz				
Maximum Frequency	Spurious Emission polarization and Level		Limit	Over Limit
MHz	polarization	dBm	dBm	dB
82.5349	Vertical	-63.45	-36.00	-27.45
151.0687	Vertical	-70.30	-36.00	-34.30
366.9741	Vertical	-68.15	-36.00	-32.15
110.1595	Horizontal	-61.57	-54.00	-7.57
294.4190	Horizontal	-65.82	-36.00	-29.82
386.1366	Horizontal	-68.88	-36.00	-32.88
Above 1 GHz				
Maximum Frequency	Spurious Emission polarization and Level		Limit	Over Limit
MHz	polarization	dBm	dBm	dB
1500.431	Vertical	-45.24	-30.00	-15.24
2569.924	Vertical	-42.59	-30.00	-12.59
4866.120	Vertical	-39.55	-30.00	-9.55
1546.741	Horizontal	-45.70	-30.00	-15.70
2979.877	Horizontal	-43.39	-30.00	-13.39
4865.217	Horizontal	-45.76	-30.00	-15.76

802.11b highest CH (2472 MHz)

below 1 GHz				
Maximum Frequency	Spurious Emission polarization and Level		Limit	Over Limit
MHz	polarization	dBm	dBm	dB
34.2090	Vertical	-69.58	-36.00	-33.58
249.2524	Vertical	-67.10	-36.00	-31.10
616.3735	Vertical	-63.32	-54.00	-9.32
85.6175	Horizontal	-64.54	-36.00	-28.54
282.5244	Horizontal	-66.20	-36.00	-30.20
699.6099	Horizontal	-62.58	-36.00	-26.58
Above 1 GHz				
Maximum Frequency	Spurious Emission polarization and Level		Limit	Over Limit
MHz	polarization	dBm	dBm	dB
1299.799	Vertical	-46.54	-30.00	-16.54
2896.621	Vertical	-44.82	-30.00	-14.82
5115.571	Vertical	-42.63	-30.00	-12.63
1936.286	Horizontal	-42.46	-30.00	-12.46
2939.790	Horizontal	-44.40	-30.00	-14.40
5178.972	Horizontal	-41.34	-30.00	-11.34

Note: All the modes had been tested, but only the worst data recorded in the report.

5.6.5 Conducted Test result

802.11b-Low CH

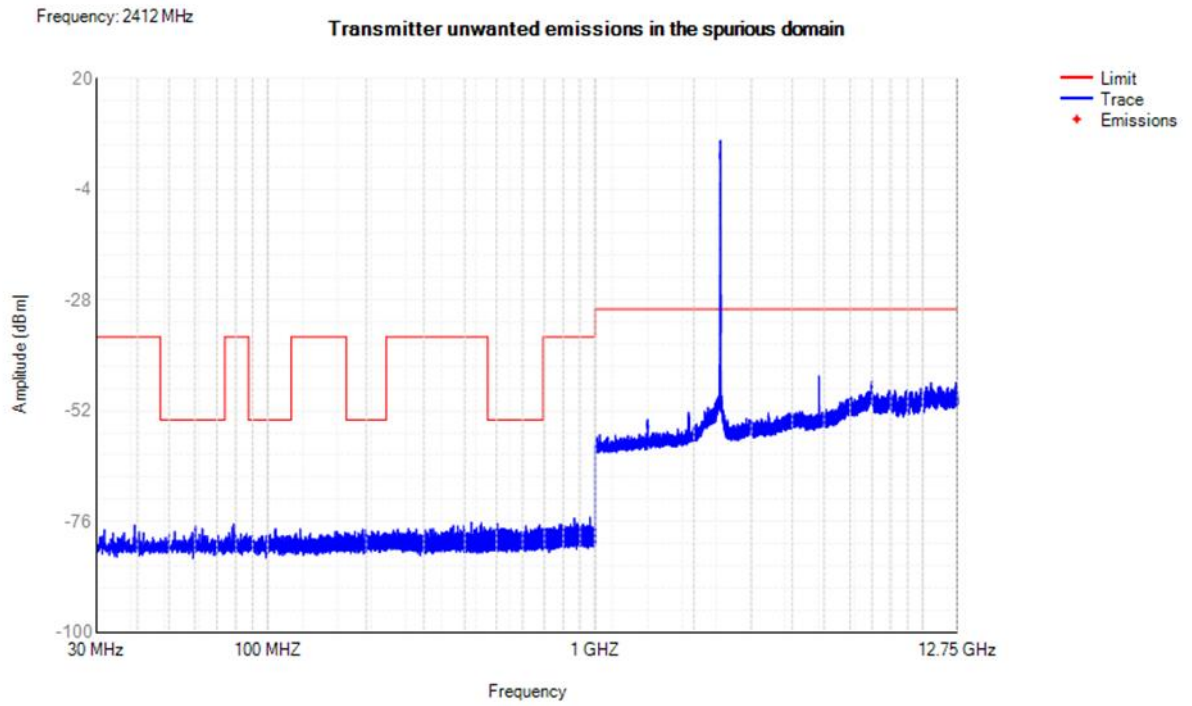

802.11b-High CH

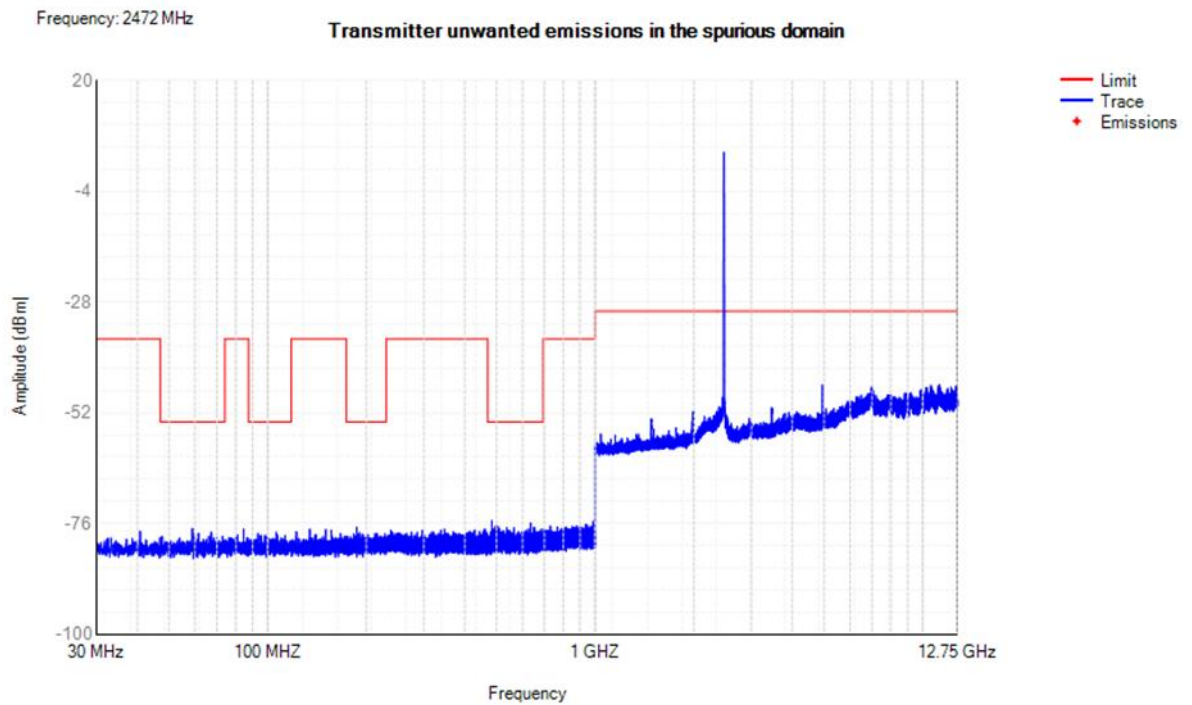

5.7 Receiver spurious emissions

5.7.1 Limit(ETSI EN 300 328 V2.2.2 (2019-07) Clause 4.3.2.10.3)

Spurious emission limits for receivers

Frequency range	Maximum power, e.r.p. (≤ 1 GHz) e.i.r.p. (> 1 GHz)	Bandwidth
30 MHz to 1 GHz	-57 dBm	100KHz
1 GHz to 12,75 GHz	-47 dBm	1MHz

5.7.2 Test procedure

Refer to ETSI EN 300 328 V2.2.2 (2019-07) Clause 5.4.10

Measurement	
<input checked="" type="checkbox"/> Conducted measurement	<input checked="" type="checkbox"/> Radiated measurement

The setting of the Spectrum Analyzer

RBW	100K(< 1 GHz) / 1M(> 1 GHz)
VBW	300K(< 1 GHz) / 3M(> 1 GHz)

5.7.3 Test Setup

Radiated measurement:

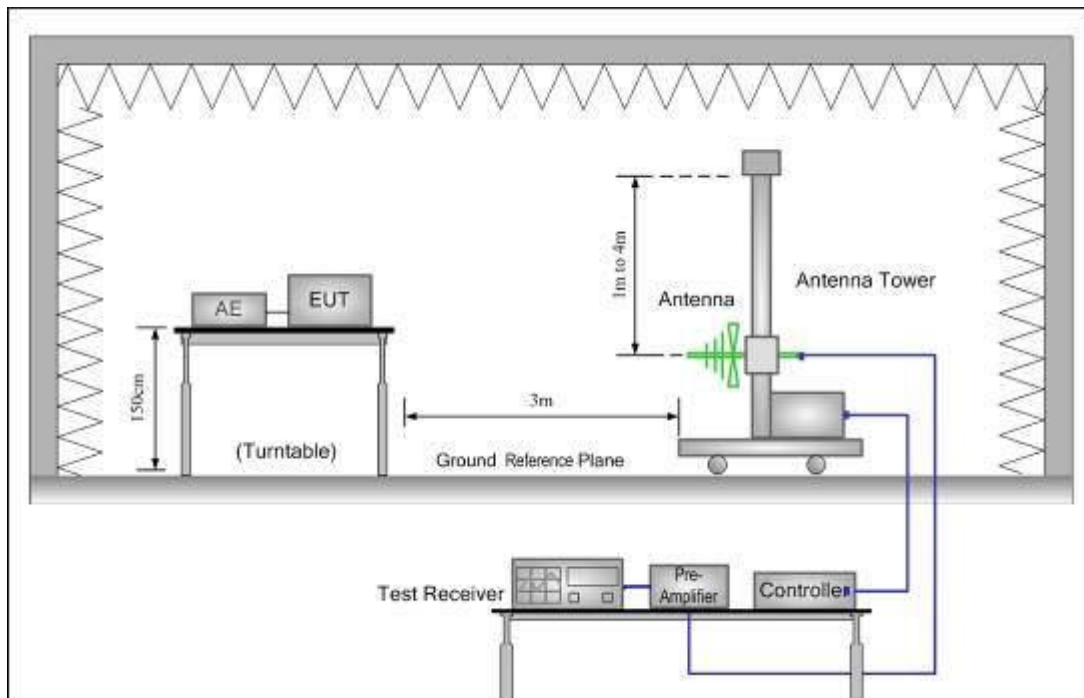

Figure 1. 30MHz to 1GHz

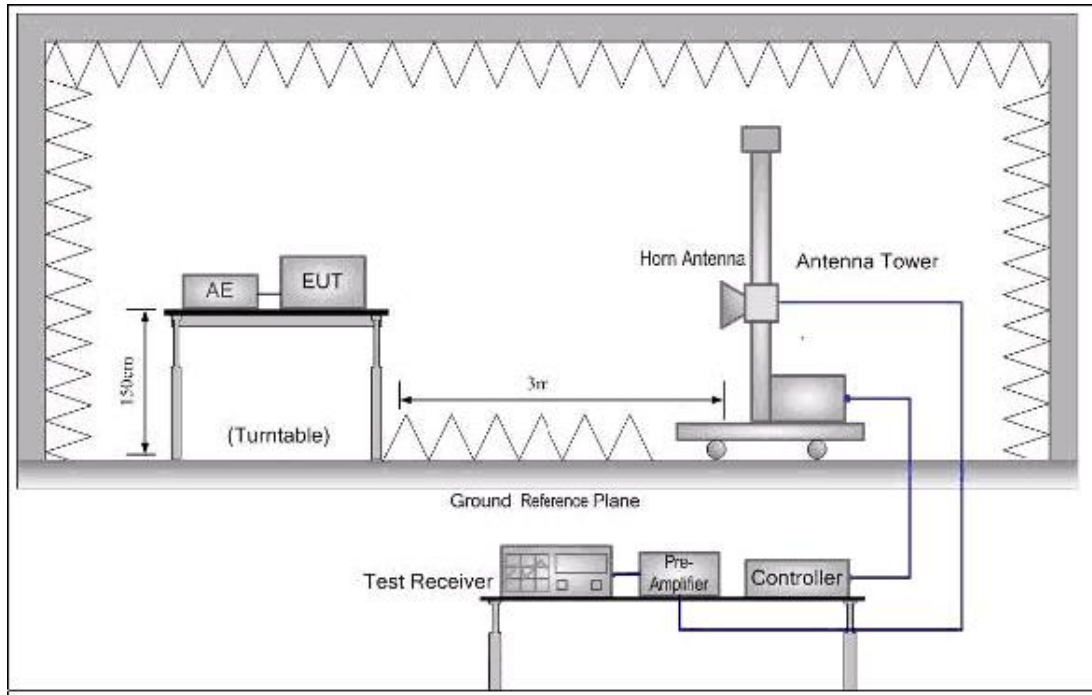
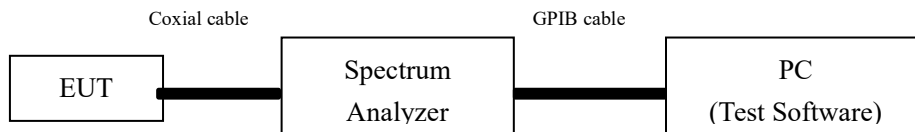

Figure 2. Above 1GHz

Conducted measurement:



1. For the actual test configuration, please refer to the related Item in this test report (Photographs of the Test Configuration).
2. Testing was performed when the equipment was in a receive-only mode.
3. The measurements were performed when normal hopping was disabled. In this case measurements were performed when operating at the lowest and the highest hopping frequency.
4. The test setup has been constructed as the normal use condition. Controlling software has been activated to set the EUT on specific status.

5.7.4 Test result(Radiated measurement)

802.11b low CH (2412 MHz)

below 1 GHz				
Maximum Frequency	Spurious Emission polarization and Level		Limit	Over Limit
MHz	polarization	dBm	dBm	dB
64.4911	Vertical	-72.09	-57.00	-15.09
207.0862	Vertical	-67.58	-57.00	-10.58
517.5058	Vertical	-67.48	-57.00	-10.48
85.9169	Horizontal	-72.00	-57.00	-15.00
330.9907	Horizontal	-69.03	-57.00	-12.03
549.8426	Horizontal	-65.91	-57.00	-8.91
Above 1 GHz				
Maximum Frequency	Spurious Emission polarization and Level		Limit	Over Limit
MHz	polarization	dBm	dBm	dB
2060.0562	Vertical	-55.66	-47.00	-8.66
3377.9131	Vertical	-52.38	-47.00	-5.38
4899.5383	Vertical	-58.35	-47.00	-11.35
1942.9679	Horizontal	-55.33	-47.00	-8.33
3112.7530	Horizontal	-55.23	-47.00	-8.23
5041.1550	Horizontal	-55.53	-47.00	-8.53

802.11b High CH (2472 MHz)

below 1 GHz				
Maximum Frequency	Spurious Emission polarization and Level		Limit of	Over Limit
MHz	polarization	dBm	dBm	dB
42.2536	Vertical	-73.73	-57.00	-16.73
413.3565	Vertical	-68.59	-57.00	-11.59
431.6191	Vertical	-64.75	-57.00	-7.75
105.3167	Horizontal	-70.97	-57.00	-13.97
179.8669	Horizontal	-71.26	-57.00	-14.26
578.7505	Horizontal	-68.06	-57.00	-11.06
Above 1 GHz				
Maximum Frequency	Spurious Emission polarization and Level		Limit	Over Limit
MHz	polarization	dBm	dBm	dB
1495.7049	Vertical	-58.55	-47.00	-11.55
3182.2447	Vertical	-54.46	-47.00	-7.46
5181.7990	Vertical	-52.61	-47.00	-5.61
2417.8177	Horizontal	-53.00	-47.00	-6.00
2626.3974	Horizontal	-59.88	-47.00	-12.88
4834.6052	Horizontal	-59.71	-47.00	-12.71

Test result(Conducted measurement)

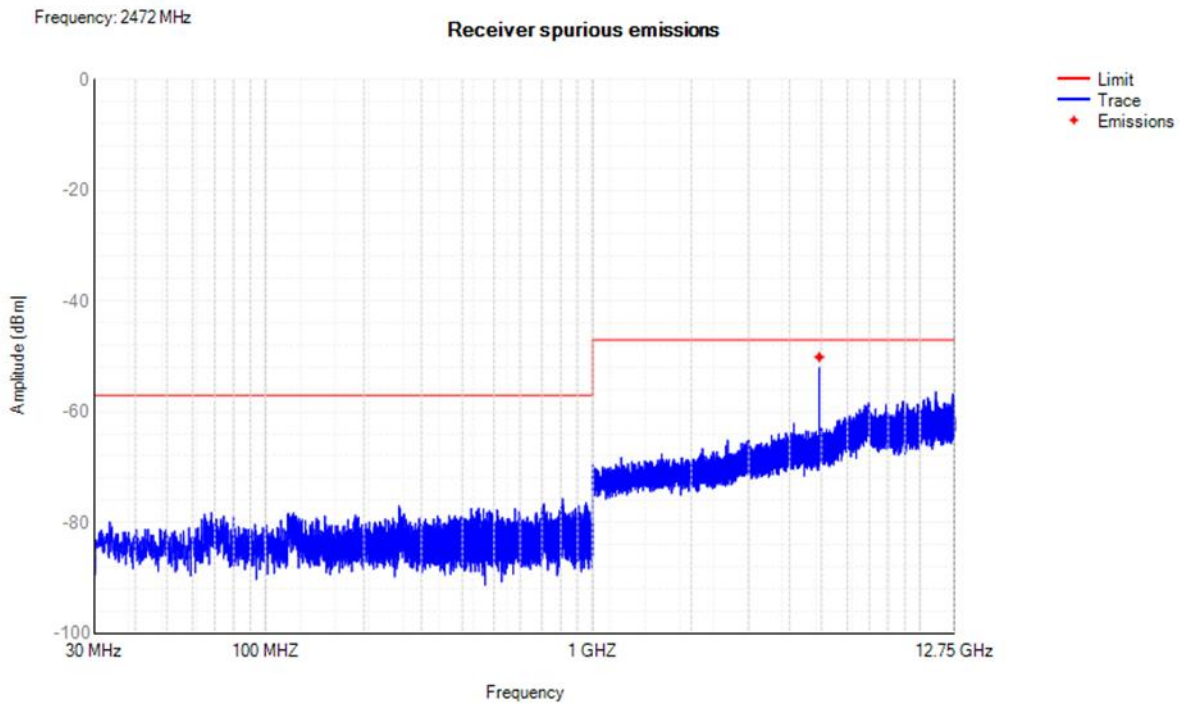
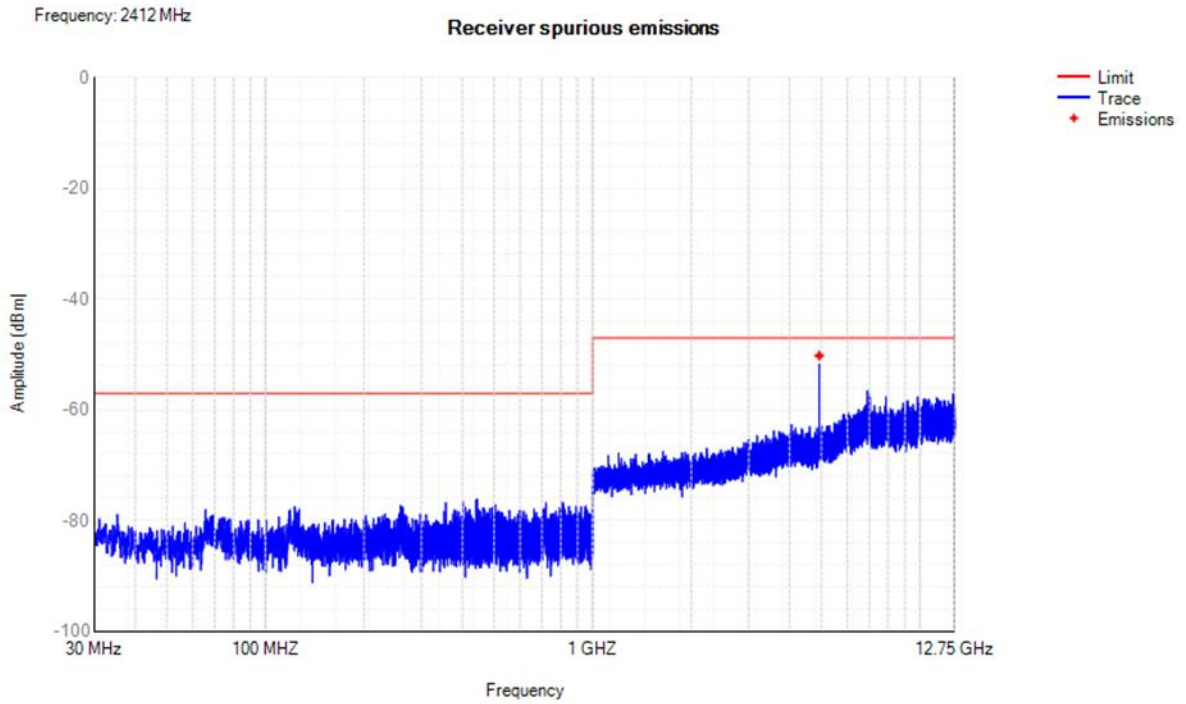

5.8 Receiver Blocking

5.8.1 Performance Criteria

The minimum performance criterion shall be a PER less than or equal to 10 %. The manufacturer may declare alternative performance criteria as long as that is appropriate for the intended use of the equipment (see clause 5.4.1.t)).

5.8.2 Limit(ETSI EN 300 328 V2.2.2 (2019-07) Clause 4.3.2.11.4)

While maintaining the minimum performance criteria as defined in clause 4.3.1.12.3, the blocking levels at specified frequency offsets shall be equal to or greater than the limits defined for the applicable receiver category provided in table 6, table 7 or table 8.

Receiver Category 1

Table 6: Receiver Blocking parameters for Receiver Category 1 equipment

Wanted signal mean power from companion device (dBm) (see notes 1 and 4)	Blocking signal frequency (MHz)	Blocking signal power (dBm) (see note 4)	Type of blocking signal
$(-133 \text{ dBm} + 10 \times \log_{10}(\text{OCBW}))$ or -68 dBm whichever is less (see note 2)	2 380 2 504	-34	CW
$(-139 \text{ dBm} + 10 \times \log_{10}(\text{OCBW}))$ or -74 dBm whichever is less (see note 3)	2 300 2 330 2 360 2 524 2 584 2 674		

NOTE 1: OCBW is in Hz.

NOTE 2: In case of radiated measurements using a companion device and the level of the wanted signal from the companion device cannot be determined, a relative test may be performed using a wanted signal up to $P_{\text{min}} + 26 \text{ dB}$ where P_{min} is the minimum level of wanted signal required to meet the minimum performance criteria as defined in clause 4.3.1.12.3 in the absence of any blocking signal.

NOTE 3: In case of radiated measurements using a companion device and the level of the wanted signal from the companion device cannot be determined, a relative test may be performed using a wanted signal up to $P_{\text{min}} + 20 \text{ dB}$ where P_{min} is the minimum level of wanted signal required to meet the minimum performance criteria as defined in clause 4.3.1.12.3 in the absence of any blocking signal.

NOTE 4: The level specified is the level at the UUT receiver input assuming a 0 dBi antenna assembly gain. In case of conducted measurements, this level has to be corrected for the (in-band) antenna assembly gain (G). In case of radiated measurements, this level is equivalent to a power flux density (PFD) in front of the UUT antenna with the UUT being configured/positioned as recorded in clause 5.4.3.2.2.

Receiver Category 2

Table 7: Receiver Blocking parameters receiver Category 2 equipment

Wanted signal mean power from companion device (dBm) (see notes 1 and 3)	Blocking signal frequency (MHz)	Blocking signal power (dBm) (see note 3)	Type of blocking signal
$(-139 \text{ dBm} + 10 \times \log_{10}(\text{OCBW}) + 10 \text{ dB})$ or $(-74 \text{ dBm} + 10 \text{ dB})$ whichever is less (see note 2)	2 380 2 504 2 300 2 584	-34	CW
<p>NOTE 1: OCBW is in Hz.</p> <p>NOTE 2: In case of radiated measurements using a companion device and the level of the wanted signal from the companion device cannot be determined, a relative test may be performed using a wanted signal up to $P_{\text{min}} + 26 \text{ dB}$ where P_{min} is the minimum level of wanted signal required to meet the minimum performance criteria as defined in clause 4.3.1.12.3 in the absence of any blocking signal.</p> <p>NOTE 3: The level specified is the level at the UUT receiver input assuming a 0 dBi antenna assembly gain. In case of conducted measurements, this level has to be corrected for the (in-band) antenna assembly gain (G). In case of radiated measurements, this level is equivalent to a power flux density (PFD) in front of the UUT antenna with the UUT being configured/positioned as recorded in clause 5.4.3.2.2.</p>			

Receiver Category 3

Table 8: Receiver Blocking parameters receiver Category 3 equipment

Wanted signal mean power from companion device (dBm) (see notes 1 and 3)	Blocking signal frequency (MHz)	Blocking signal power (dBm) (see note 3)	Type of blocking Signal
$(-139 \text{ dBm} + 10 \times \log_{10}(\text{OCBW}) + 20 \text{ dB})$ or $(-74 \text{ dBm} + 20 \text{ dB})$ whichever is less (see note 2)	2 380 2 504 2 300 2 584	-34	CW
<p>NOTE 1: OCBW is in Hz.</p> <p>NOTE 2: In case of radiated measurements using a companion device and the level of the wanted signal from the companion device cannot be determined, a relative the test may be performed using a wanted signal up to $P_{\text{min}} + 30 \text{ dB}$ where P_{min} is the minimum level of wanted signal required to meet the minimum performance criteria as defined in clause 4.3.1.12.3 in the absence of any blocking signal.</p> <p>NOTE 3: The level specified is the level at the UUT receiver input assuming a 0 dBi antenna assembly gain. In case of conducted measurements, this level has to be corrected for the (in-band) antenna assembly gain (G). In case of radiated measurements, this level is equivalent to a power flux density (PFD) in front of the UUT antenna with the UUT being configured/positioned as recorded in clause 5.4.3.2.2.</p>			

5.8.3 Test procedure

Refer to ETSI EN 300 328 V2.2.2 (2019-07) Clause 5.4.11.2

Measurement	
<input checked="" type="checkbox"/> Conducted measurement	<input type="checkbox"/> Radiated measurement

5.8.4 Test Setup

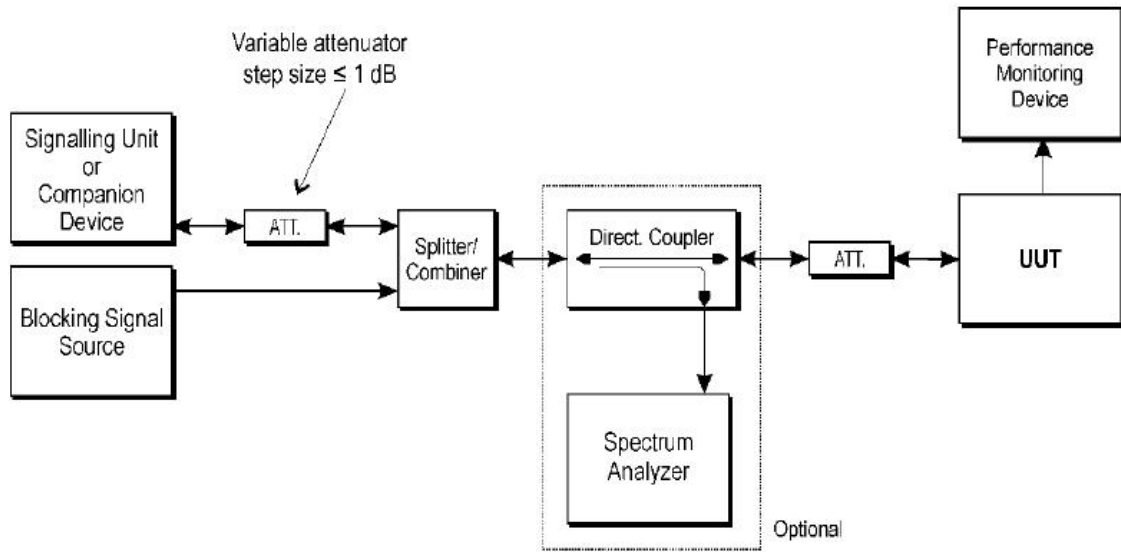

5.8.5 Test result

Note: The power more than 10dBm, belong to category 1.

802.11b

Receiver category 1

Wanted signal mean power from companion device (dBm) _{Note(1)}	Test Channel	Blocking signal Frequency (MHz)	Blocking signal power (dBm)	PER% Note(2)	PER Limit %
-68 dB	low	2 380	-34	4.2	≤10%
	High	2 504		3.6	
-74dB	low	2 300		3.8	≤10%
		2 330		3.3	
		2 360		4.2	
	High	2 524		3.5	≤10%
		2 584		3.0	
		2 674		3.5	

NOTE 1: In case of radiated measurements using a companion device and the level of the wanted signal from the companion device cannot be determined, a relative test may be performed using a wanted signal up to P_{min} + 26 dB where P_{min} is the minimum level of wanted signal required to meet the minimum performance criteria as defined in clause 4.3.1.12.3 in the absence of any blocking signal.

NOTE 3: In case of radiated measurements using a companion device and the level of the wanted signal from the companion device cannot be determined, a relative test may be performed using a wanted signal up to P_{min} + 20 dB where P_{min} is the minimum level of wanted signal required to meet the minimum performance criteria as defined in clause 4.3.1.12.3 in the absence of any blocking signal.

NOTE 4: The level specified is the level at the UUT receiver input assuming a 0 dBi antenna assembly gain. In case of conducted measurements, this level has to be corrected for the (in-band) antenna assembly gain (G). In case of radiated measurements, this level is equivalent to a power flux density (PFD) in front of the UUT antenna with the UUT being configured/positioned as recorded in clause 5.4.3.2.2.

Note: The above results were obtained from laboratory tests.

802.11g
Receiver category 1

Wanted signal mean power from companion device (dBm) ^{Note(1)}	Test Channel	Blocking signal Frequency (MHz)	Blocking signal power (dBm)	PER% Note(2)	PER Limit %
-68 dB	low	2 380	-34	3.5	≤10%
	High	2 504		3.1	
-74dB	low	2 300		3.3	≤10%
		2 330		3.3	
		2 360		3.3	
	High	2 524		2.9	≤10%
		2 584		3.6	
		2 674		3.4	

NOTE 1: In case of radiated measurements using a companion device and the level of the wanted signal from the companion device cannot be determined, a relative test may be performed using a wanted signal up to Pmin + 26 dB where Pmin is the minimum level of wanted signal required to meet the minimum performance criteria as defined in clause 4.3.1.12.3 in the absence of any blocking signal.

NOTE 3: In case of radiated measurements using a companion device and the level of the wanted signal from the companion device cannot be determined, a relative test may be performed using a wanted signal up to Pmin + 20 dB where Pmin is the minimum level of wanted signal required to meet the minimum performance criteria as defined in clause 4.3.1.12.3 in the absence of any blocking signal.

NOTE 4: The level specified is the level at the UUT receiver input assuming a 0 dBi antenna assembly gain. In case of conducted measurements, this level has to be corrected for the (in-band) antenna assembly gain (G). In case of radiated measurements, this level is equivalent to a power flux density (PFD) in front of the UUT antenna with the UUT being configured/positioned as recorded in clause 5.4.3.2.2.

Note: The above results were obtained from laboratory tests.

802.11n20

Receiver category 1

Wanted signal mean power from companion device (dBm) ^{Note(1)}	Test Channel	Blocking signal Frequency (MHz)	Blocking signal power (dBm)	PER% Note(2)	PER Limit %
-68 dB	low	2 380	-34	3.3	≤10%
	High	2 504		3.2	
-74dB	low	2 300		3.8	≤10%
		2 330		3.1	
		2 360		3.3	
	High	2 524		3.4	≤10%
		2 584		3.3	
		2 674		3.8	

NOTE 1: In case of radiated measurements using a companion device and the level of the wanted signal from the companion device cannot be determined, a relative test may be performed using a wanted signal up to $P_{min} + 26$ dB where P_{min} is the minimum level of wanted signal required to meet the minimum performance criteria as defined in clause 4.3.1.12.3 in the absence of any blocking signal.

NOTE 3: In case of radiated measurements using a companion device and the level of the wanted signal from the companion device cannot be determined, a relative test may be performed using a wanted signal up to $P_{min} + 20$ dB where P_{min} is the minimum level of wanted signal required to meet the minimum performance criteria as defined in clause 4.3.1.12.3 in the absence of any blocking signal.

NOTE 4: The level specified is the level at the UUT receiver input assuming a 0 dBi antenna assembly gain. In case of conducted measurements, this level has to be corrected for the (in-band) antenna assembly gain (G). In case of radiated measurements, this level is equivalent to a power flux density (PFD) in front of the UUT antenna with the UUT being configured/positioned as recorded in clause 5.4.3.2.2.

Note: The above results were obtained from laboratory tests.

802.11n40

Receiver category 2

Wanted signal mean power from companion device (dBm) ^{Note(1)}	Test Channel	Blocking signal Frequency (MHz)	Blocking signal power (dBm)	PER% Note(2)	PER Limit %
-68 dB	low	2 380	-34	3.8	≤10%
	High	2 504		3.2	
	low	2 300		3.4	≤10%
	High	2 584		3.0	

NOTE 1: In case of radiated measurements using a companion device and the level of the wanted signal from the companion device cannot be determined, a relative test may be performed using a wanted signal up to P_{min} + 26 dB where P_{min} is the minimum level of wanted signal required to meet the minimum performance criteria as defined in clause 4.3.1.12.3 in the absence of any blocking signal.

NOTE 3: In case of radiated measurements using a companion device and the level of the wanted signal from the companion device cannot be determined, a relative test may be performed using a wanted signal up to P_{min} + 20 dB where P_{min} is the minimum level of wanted signal required to meet the minimum performance criteria as defined in clause 4.3.1.12.3 in the absence of any blocking signal.

NOTE 4: The level specified is the level at the UUT receiver input assuming a 0 dBi antenna assembly gain. In case of conducted measurements, this level has to be corrected for the (in-band) antenna assembly gain (G). In case of radiated measurements, this level is equivalent to a power flux density (PFD) in front of the UUT antenna with the UUT being configured/positioned as recorded in clause 5.4.3.2.2.

Note: The above results were obtained from laboratory tests.

802.11ax20

Receiver category 1

Wanted signal mean power from companion device (dBm) ^{Note(1)}	Test Channel	Blocking signal Frequency (MHz)	Blocking signal power (dBm)	PER% Note(2)	PER Limit %
-68 dB	low	2 380	-34	3.4	≤10%
	High	2 504		3.3	
-74dB	low	2 300		3.9	≤10%
		2 330		3.1	
		2 360		3.5	
	High	2 524		2.9	≤10%
		2 584		3.4	
		2 674		4.1	

NOTE 1: In case of radiated measurements using a companion device and the level of the wanted signal from the companion device cannot be determined, a relative test may be performed using a wanted signal up to P_{min} + 26 dB where P_{min} is the minimum level of wanted signal required to meet the minimum performance criteria as defined in clause 4.3.1.12.3 in the absence of any blocking signal.

NOTE 3: In case of radiated measurements using a companion device and the level of the wanted signal from the companion device cannot be determined, a relative test may be performed using a wanted signal up to P_{min} + 20 dB where P_{min} is the minimum level of wanted signal required to meet the minimum performance criteria as defined in clause 4.3.1.12.3 in the absence of any blocking signal.

NOTE 4: The level specified is the level at the UUT receiver input assuming a 0 dBi antenna assembly gain. In case of conducted measurements, this level has to be corrected for the (in-band) antenna assembly gain (G). In case of radiated measurements, this level is equivalent to a power flux density (PFD) in front of the UUT antenna with the UUT being configured/positioned as recorded in clause 5.4.3.2.2.

Note: The above results were obtained from laboratory tests.

802.11ax40

Receiver category 2

Wanted signal mean power from companion device (dBm) ^{Note(1)}	Test Channel	Blocking signal Frequency (MHz)	Blocking signal power (dBm)	PER% Note(2)	PER Limit %
-68 dB	low	2 380	-34	3.2	≤10%
	High	2 504		3.3	
	low	2 300		3.6	≤10%
	High	2 584		3.1	

NOTE 1: In case of radiated measurements using a companion device and the level of the wanted signal from the companion device cannot be determined, a relative test may be performed using a wanted signal up to P_{min} + 26 dB where P_{min} is the minimum level of wanted signal required to meet the minimum performance criteria as defined in clause 4.3.1.12.3 in the absence of any blocking signal.

NOTE 3: In case of radiated measurements using a companion device and the level of the wanted signal from the companion device cannot be determined, a relative test may be performed using a wanted signal up to P_{min} + 20 dB where P_{min} is the minimum level of wanted signal required to meet the minimum performance criteria as defined in clause 4.3.1.12.3 in the absence of any blocking signal.

NOTE 4: The level specified is the level at the UUT receiver input assuming a 0 dBi antenna assembly gain. In case of conducted measurements, this level has to be corrected for the (in-band) antenna assembly gain (G). In case of radiated measurements, this level is equivalent to a power flux density (PFD) in front of the UUT antenna with the UUT being configured/positioned as recorded in clause 5.4.3.2.2.

Note: The above results were obtained from laboratory tests.

6 Test Setup photograph

Spurious Emission Test Setup

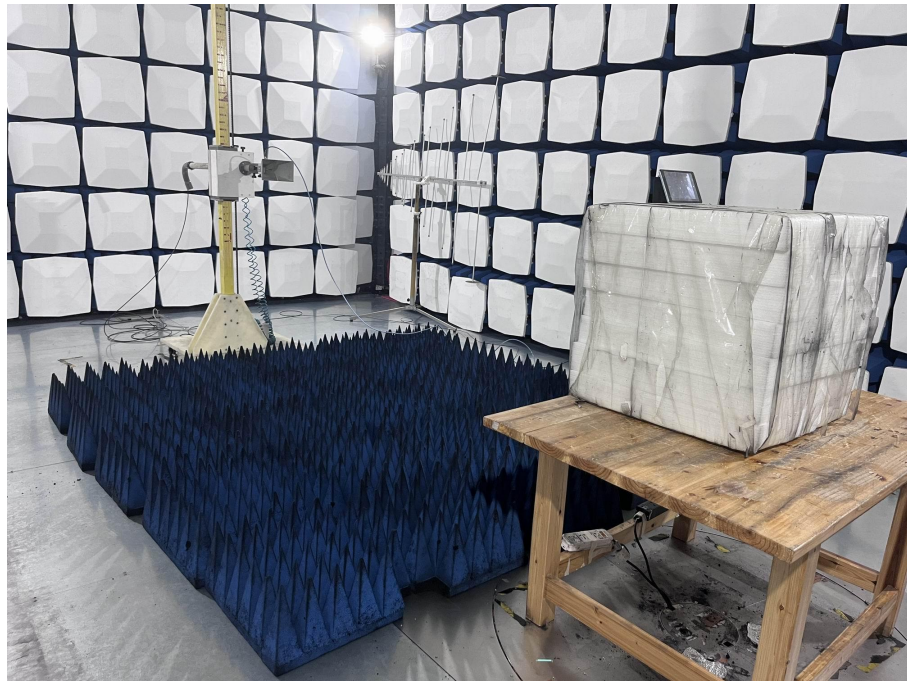
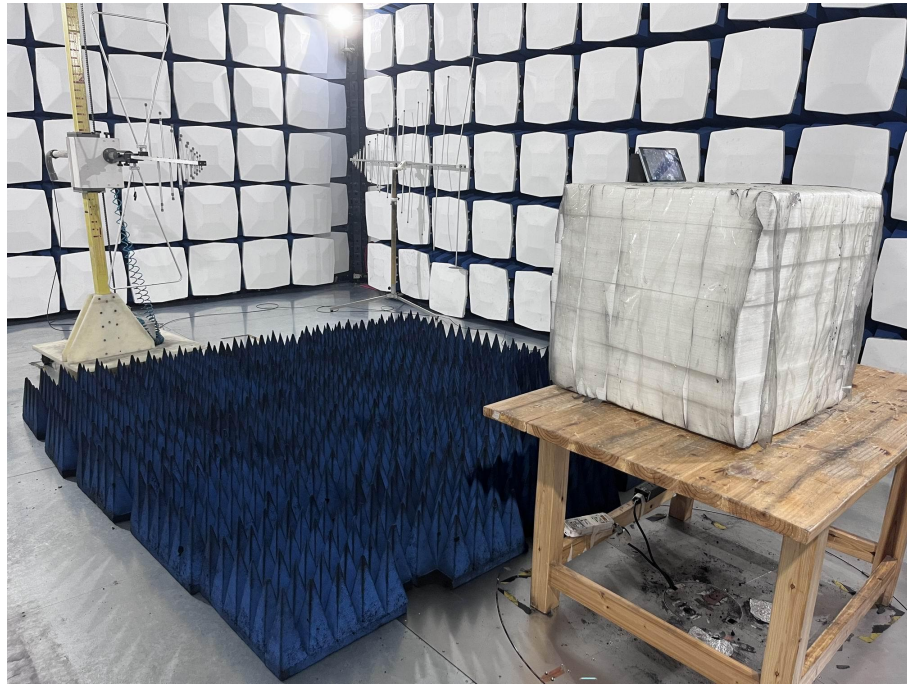

**** End of report ****