

EMC TEST REPORT

The device described below is tested by Dongguan Nore Testing Center Co., Ltd. to determine the maximum emission levels emanating from the device, the severe levels which the device can endure and E.U.T.'s performance criterion. The test results, data evaluation, test procedures, and equipment of configurations shown in this report were made in accordance with the RED directive 2014/53/EU.

Applicant : SHENZHEN FENDA TECHNOLOGY CO., LTD.
Address : Fenda Hi-Tech Park, Zhoushi Road, Shiyao Town, Baoan District, Shenzhen City, Guangdong, China
Manufacturer /Factory : SHENZHEN FENDA TECHNOLOGY CO., LTD.
Address : Fenda Hi-Tech Park, Zhoushi Road, Shiyao Town, Baoan District, Shenzhen City, Guangdong, China
E.U.T. : 2.0 Multimedia Speaker
Brand Name : F&D
Model No. : R40BT, R44BT, R50BT, R55BT, R27BT, R24BT, R25BT
(For model difference refer to section 1)
Measurement Standard : Draft ETSI EN 301 489-1 v 2.2.1: 2019
Draft ETSI EN 301 489-17 v 3.2.0: 2017
Date of Receiver : July 04, 2019
Date of Test : July 05, 2019 to July 16, 2019
Date of Report : July 17, 2019

This Test Report is Issued Under the Authority of :

Prepared by

Approved & Authorized Signer

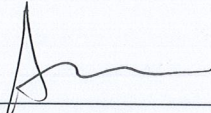
Alina Guo / Engineer

Iori Fan / Authorized Signatory

This test report is for the customer shown above and their specific product only. This report applies to above tested sample only and shall not be reproduced in part without written approval of Dongguan Nore Testing Center Co., Ltd.

TABLE OF CONTENTS

1. GENERAL INFORMATION	4
PRODUCT DESCRIPTION FOR EQUIPMENT UNDER TEST	4
2. SUMMARY OF TEST RESULTS	6
3. TEST METHODOLOGY	7
4. MEASURING INSTRUMENT CALIBRATIONA	7
5. TEST FACILITY	7
6. SUPPORT EQUIPMENT	8
7. PERFORMANCE CRITERIA.....	9
8. ETSI EN 301 489-1/-17 REQUIREMENTS.....	10
8.1 RADIATED EMISSION LIMIT	10
8.2 AC POWER CONDUCTED EMISSION.....	16
8.3 AC MAINS HARMONIC CURRENT EMISSION	19
8.4 AC MAINS VOLTAGE FLUCTUATION AND FLICKER	20
8.5 ELECTROSTATIC DISCHARGE	22
8.6 RF ELECTROMAGNETIC FIELD.....	25
8.7 AC MAINS FAST TRANSIENTS COMMON MODE.....	27
8.8 AC MAINS SURGE	29
8.9 RADIO FREQUENCY COMMON MODE	31
8.10 VOLTAGE DIPS AND INTERRUPTION	33
8.11 TEST EQUIPMENT LIST	35
FOR MAINS TERMINALS DISTURBANCE VOLTAGE TEST.....	35
FOR RADIATED EMISSION MEASUREMENT.....	35
FOR HARMONIC / FLICKER MEASUREMENT.....	35
FOR ELECTROSTATIC DISCHARGE TEST	36
FOR RF ELECTROMAGNETIC FIELD IMMUNITY TEST	36
FOR ELECTRICAL FAST TRANSIENT /BURST IMMUNITY TEST	36
FOR SURGE IMMUNITY TEST.....	37
FOR INJECTED CURRENTS IMMUNITY MEASUREMENT.....	37
FOR VOLTAGE DIPS AND INTERRUPTIONS MEASUREMENT	37

1. GENERAL INFORMATION

PRODUCT DESCRIPTION FOR EQUIPMENT UNDER TEST

E.U.T.	:	2.0 Multimedia Speaker
Main Model Name	:	R40BT
Additional Model name	:	R44BT, R50BT, R55BT, R27BT, R24BT, R25BT
Brand Name	:	F&D
Rating	:	AC 100-240V 50/60Hz
Adapter	:	N/A
Test Voltage	:	AC 230V 50Hz, AC 110V 60Hz Only the worst case was recorded in the report.
Cable	:	Audio Line: 1 to 2: 1.54m unshielded Speaker Line: 1.97m unshielded AC Mains: 1.78m unshielded
Hardware version	:	V1.0
Software version	:	V1.0
Operating Temperature Range	:	0°C to 35°C (Declaration by manufacturer)
Description of model difference	:	These models have the same circuit schematic, construction, PCB Layout and critical components. The difference is model number and color only due to trading purpose.
Note	:	According to the model difference, all tests were performed on model R40BT.

Technical Specification:

Item	:	Description
BT Version	:	4.2
Frequency	:	2402-2480MHz
Modulation	:	GFSK, $\pi/4$ -DQPSK, 8DPSK
Number of Channel	:	79
Channel space	:	1MHz
Antenna Type	:	PCB antenna
Antenna Gain	:	0.5dBi (declared by manufacturer)

2. SUMMARY OF TEST RESULTS

The E.U.T. has been tested according to the following specifications:

Draft ETSI EN 301 489-1 v 2.2.1: 2019/ Draft ETSI EN 301 489-17 v 3.2.0: 2017			
EMISSION			
Standard	Test Type	Result	Remarks
EN 55032: 2015	Mains Terminal Disturbance Voltage Test	PASS	Uncertainty: 2.7dB
	Radiated Emission Test	PASS	Uncertainty: 3.4dB
EN 61000-3-2: 2014	Harmonic current emission	PASS	Meets the requirements.
EN 61000-3-3: 2013	Voltage fluctuations & flicker	PASS	Meets the requirements.
IMMUNITY			
Standard	Test Type	Result	Remarks
EN 61000-4-2: 2009	Electrostatic discharge immunity test	PASS	Meets the requirements of Performance Criterion B
EN 61000-4-3: 2006+A2: 2010	Radio-frequency, electromagnetic field immunity test	PASS	Meets the requirements of Performance Criterion A
EN 61000-4-4: 2012	Electrical fast transient/ burst immunity test	PASS	Meets the requirements of Performance Criterion B
EN 61000-4-5: 2014	Surge immunity test	PASS	Meets the requirements of Performance Criterion B
EN 61000-4-6: 2014	Injected Currents immunity test	PASS	Meets the requirements of Performance Criterion A
EN 61000-4-11: 2004	Voltage Dips and Interruptions	PASS	Meets the requirements of Performance Criterion B&C

3. TEST METHODOLOGY

As per table 2 of clause 7.1 of Draft ETSI EN 301 489-1 V2.2.1, the measurement was performed under EUT combined condition during the tests. The ports on the ancillary left empty during the measurement in this report.

4. MEASURING INSTRUMENT CALIBRATION

The measuring equipment, which was utilized in performing the tests documented herein, has been calibrated in accordance with the manufacturer's recommendations for utilizing calibration equipment, which is traceable to recognized national standards.

5. TEST FACILITY

Site Description

EMC Lab : Listed by CNAS, August 13, 2018
The certificate is valid until August 13, 2024
The Laboratory has been assessed and proved to be in compliance with CNAS/CL01
The Certificate Registration Number is L5795.

Listed by A2LA, November 01, 2017
The certificate is valid until December 31, 2019
The Laboratory has been assessed and proved to be in compliance with ISO17025
The Certificate Registration Number is 4429.01

Listed by FCC, November 06, 2017
The Designation Number is CN1214
Test Firm Registration Number: 907417

Listed by Industry Canada, June 08, 2017
The Certificate Registration Number. Is 46405-9743

Name of Firm : Dongguan Nore Testing Center Co., Ltd.
(Dongguan NTC Co., Ltd.)

Site Location : Building D, Gaosheng Science and Technology
Park, Hongtu Road, Nancheng District, Dongguan
City, Guangdong Province, China

6. SUPPORT EQUIPMENT

Mobile Phone	:	Manufacturer: HUAWEI M/N: HWI-AL00 S/N: TAG-TL00C01B166
Mobile Phone	:	Manufacturer: Xiaomi M/N: MI8

7. PERFORMANCE CRITERIA

Draft ETSI EN301489-17 v 3.2.0: 2017		
Criteria	During Test	After Test
A	Shall operate as intended. (see note 1). Shall be no loss of function. Shall be no unintentional transmissions.	Shall operate as intended. Shall be no degradation of performance (see note 3). Shall be no loss of function. Shall be no loss of stored data or user programmable functions.
B	May show loss of function (one or more). May show degradation of performance (see note 2). Shall be no unintentional transmissions.	Functions shall be self-recoverable. Shall operate as intended after recovering. Shall be no degradation of performance (see note 3). Shall be no loss of stored data or user programmable functions.
C	May be loss of function (one or more).	Functions shall be recoverable by the operator. Shall operate as intended after recovering. Shall be no degradation of performance (see note 3).
<p>NOTE 1: Operate as intended during the test allows a level of degradation not below a minimum performance level specified by the manufacturer for the use of the apparatus as intended. In some cases the specified minimum performance level may be replaced by a permissible degradation of performance. If the minimum performance level or the permissible performance degradation is not specified by the manufacturer then either of these may be derived from the product description and documentation (including leaflets and advertising) and what the user may reasonably expect from the apparatus if used as intended.</p> <p>NOTE 2: Degradation of performance during the test is understood as a degradation to a level not below a minimum performance level specified by the manufacturer for the use of the apparatus as intended. In some cases the specified minimum performance level may be replaced by a permissible degradation of performance. If the minimum performance level or the permissible performance degradation is not specified by the manufacturer then either of these may be derived from the product description and documentation (including leaflets and advertising) and what the user may reasonably expect from the apparatus if used as intended.</p> <p>NOTE 3: No degradation of performance after the test is understood as no degradation below a minimum performance level specified by the manufacturer for the use of the apparatus as intended. In some cases the specified minimum performance level may be replaced by a permissible degradation of performance. After the test no change of actual operating data or user retrievable data is allowed. If the minimum performance level or the permissible performance degradation is not specified by the manufacturer then either of these may be derived from the product description and documentation (including leaflets and advertising) and what the user may reasonably expect from the apparatus if used as intended.</p>		

Performance Criteria For Continuous Phenomena (CT & CR)

At the conclusion of the test the EUT shall operated as intended with no loss of user control functions or stored data, the communication link shall have been maintained during the test.

Performance Criteria For Transient Phenomena (TT & TR)

At the conclusion of each exposure the EUT shall operated with no user noticeable loss of communication link.

8. ETSI EN 301 489-1/-17 REQUIREMENTS

8.1 RADIATED EMISSION LIMIT

According standard Draft ETSI EN 301 489-1 v 2.2.1 Clause 8.2.3, Table 3 and EN 55032: 2015 Clause 6, Table 6, Class B

Limits for radiated disturbance Blow 1GHz

FREQUENCY (MHz)	DISTANCE (Meters)	FIELD STRENGTHS LIMIT (dB μ V/m)
30 ~ 230	3	40
230 ~ 1000	3	47

Note: (1) The smaller limit shall apply at the combination point between two frequency bands.
 (2) Distance refers to the distance in meters between the measuring instrument antenna and the closed point of any part of the EUT.

Limits for radiated disturbance Above 1GHz

FREQUENCY (MHz)	DISTANCE (Meters)	Average Limit (dB μ V/m)	Peak Limit (dB μ V/m)
1000 ~ 3000	3	50	70
3000 ~ 6000	3	54	74

Note: The lower limit applies at the transition frequency.

TEST CONFIGURATION

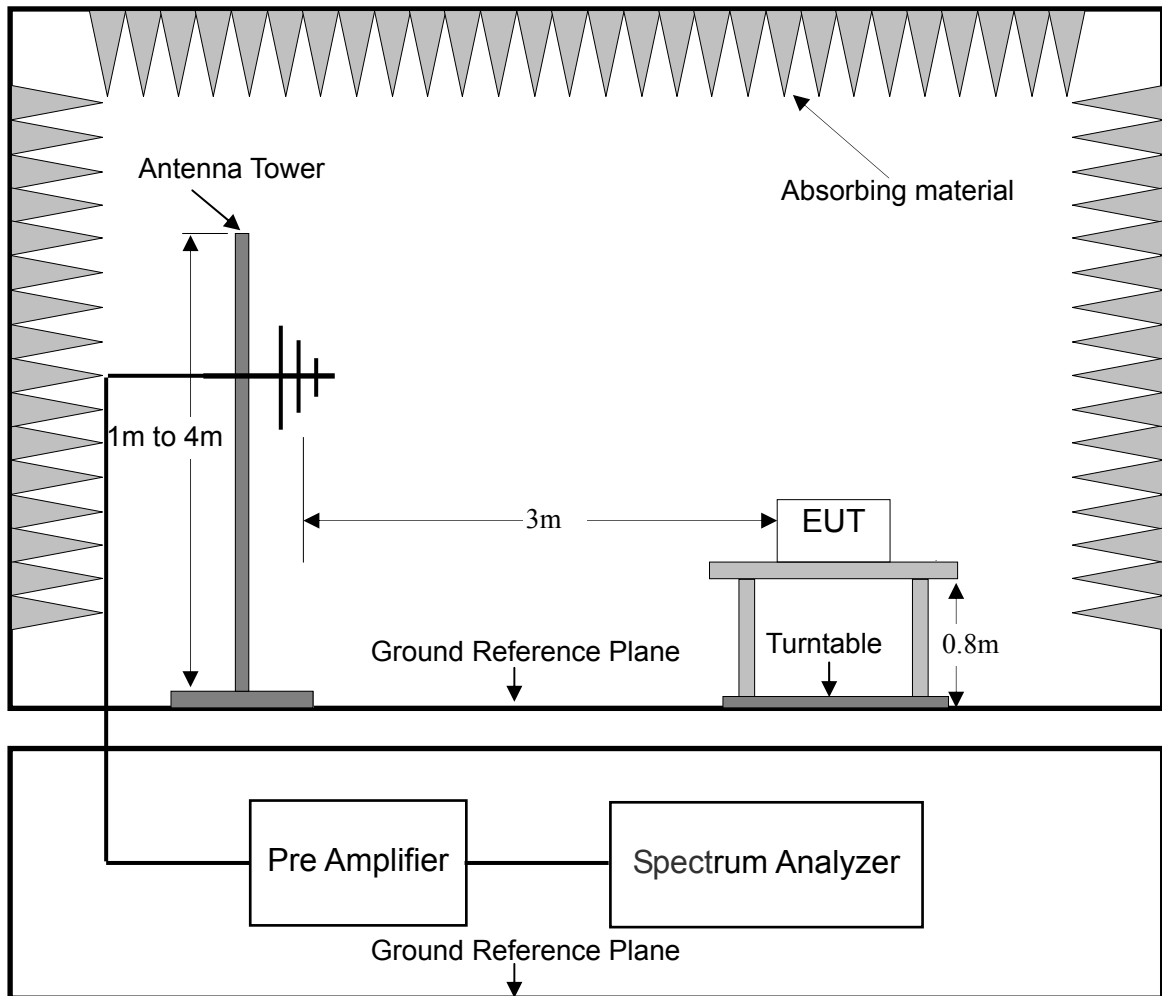

TEST PROCEDURE

Please refer to Draft ETSI EN 301 489-1 V2.2.1 Clause 8.2.3 and EN 55032: 2015 Clause 6 for the measurement methods.

TEST RESULT

PASS

Please refer to following data tables.



Dongguan NTC Co., Ltd.
Tel:+86-769-22022444 Fax:+86-769-22022799
Web: [Http://www.ntc-c.com](http://www.ntc-c.com)

Radiated Emission Measurement

File :R40BT Data :#3 Date: 2019/7/8 Time: 21:52:41

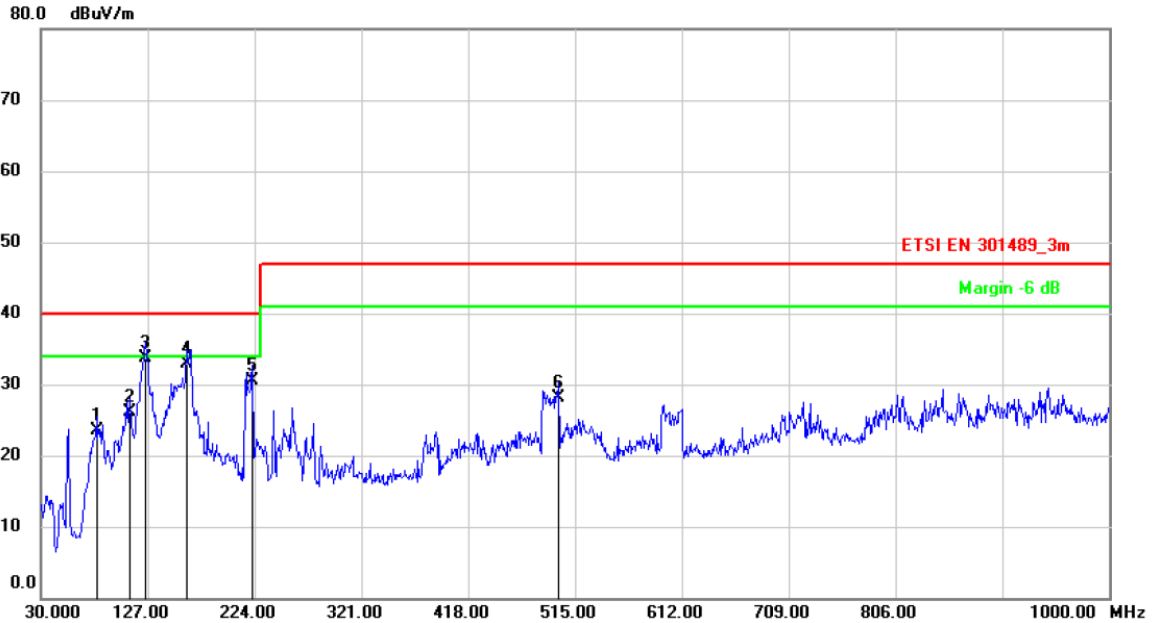

Site: 3m Chamber Polarization: *Horizontal* Temperature: 26
 Limit: ETSI EN 301489_3m Power: AC230V/50Hz Humidity: 47 %
 EUT: 2.0 Multimedia Speaker Distance: 3m
 M/N: R40BT
 Mode: BT Link
 Note:

No.	Mk.	Freq.	Reading Level	Correct Factor	Measurement	Limit	Over	Antenna Height	Table Degree	
		MHz	dBuV	dB/m	dBuV/m	dBuV/m	dB	cm	degree	Comment
1		80.4400	39.54	-16.04	23.50	40.00	-16.50			QP
2		110.5100	38.36	-12.26	26.10	40.00	-13.90			QP
3	*	125.0600	48.42	-14.62	33.80	40.00	-6.20			QP
4		161.9200	47.98	-15.08	32.90	40.00	-7.10			QP
5		222.0600	43.46	-12.86	30.60	40.00	-9.40			QP
6		500.4500	34.96	-6.76	28.20	47.00	-18.80			QP

*:Maximum data x:Over limit !:over margin

<Reference Only



Dongguan NTC Co., Ltd.
Tel: +86-769-22022444 Fax: +86-769-22022799
Web: [Http://www.ntc-c.com](http://www.ntc-c.com)

Radiated Emission Measurement

File :R40BT Data :#4 Date: 2019/7/8 Time: 21:59:11

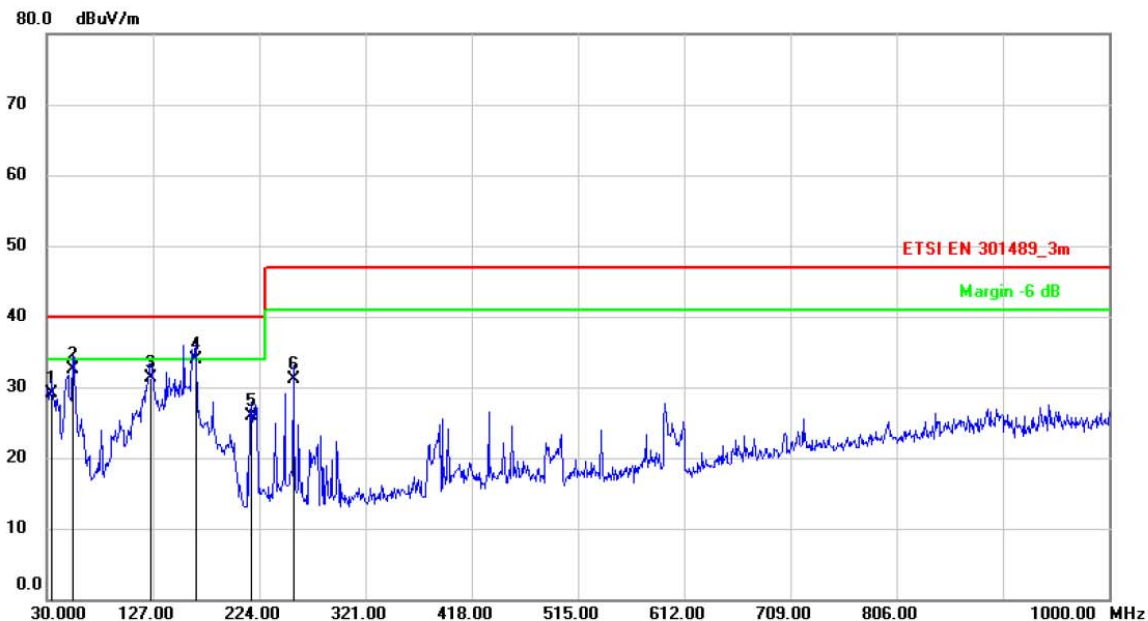

Site: 3m Chamber Polarization: **Vertical** Temperature: 26
Limit: ETSI EN 301489_3m Power: AC230V/50Hz Humidity: 47 %
EUT: 2.0 Multimedia Speaker Distance: 3m
M/N: R40BT
Mode: BT Link
Note:

No.	Mk.	Freq.	Reading Level	Correct Factor	Measurement	Limit	Over	Antenna Height	Table Degree	
		MHz	dBuV	dB/m	dBuV/m	dBuV/m	dB	cm	degree	Comment
1		34.8500	45.27	-16.17	29.10	40.00	-10.90	QP		
2		53.2800	46.07	-13.57	32.50	40.00	-7.50	QP		
3		125.0600	48.92	-17.62	31.30	40.00	-8.70	QP		
4	*	165.8000	51.95	-17.95	34.00	40.00	-6.00	QP		
5		216.2400	41.98	-16.08	25.90	40.00	-14.10	QP		
6		255.0400	44.65	-13.55	31.10	47.00	-15.90	QP		

*:Maximum data x:Over limit !:over margin

⟨Reference Only



Dongguan NTC Co., Ltd.
Tel:+86-769-22022444 Fax:+86-769-22022799
Web: [Http://www.ntc-c.com](http://www.ntc-c.com)

Radiated Emission Measurement

File :R40BT Data :#2 Date: 2019/7/8 Time: 21:45:20

100.0 dBuV/m

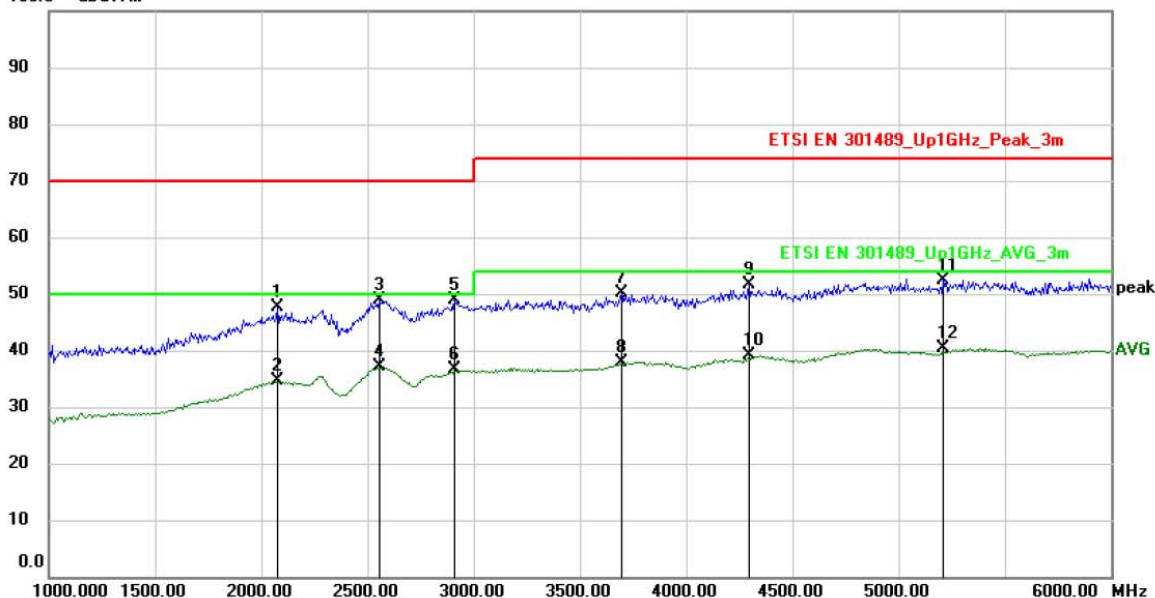

Site: 3m Chamber Polarization: **Horizontal** Temperature: 26
Limit: ETSI EN 301489_Up1GHz_Peak_3m Power: AC230V/50Hz Humidity: 47 %
EUT: 2.0 Multimedia Speaker Distance: 3m
M/N: R40BT
Mode: BT Link
Note:

No.	Mk.	Freq.	Reading Level	Correct Factor	Measurement	Limit	Over	Antenna Height	Table Degree	
		MHz	dBuV	dB/m	dBuV/m	dBuV/m	dB	cm	degree	Comment
1		2075.000	48.31	-0.68	47.63	70.00	-22.37			peak
2		2075.000	35.31	-0.68	34.63	50.00	-15.37			AVG
3		2556.250	48.19	0.60	48.79	70.00	-21.21			peak
4	*	2556.250	36.53	0.60	37.13	50.00	-12.87			AVG
5		2912.500	47.23	1.62	48.85	70.00	-21.15			peak
6		2912.500	34.89	1.62	36.51	50.00	-13.49			AVG
7		3693.750	47.01	3.14	50.15	74.00	-23.85			peak
8		3693.750	34.76	3.14	37.90	54.00	-16.10			AVG
9		4293.750	46.99	4.64	51.63	74.00	-22.37			peak
10		4293.750	34.39	4.64	39.03	54.00	-14.97			AVG
11		5212.500	45.63	6.86	52.49	74.00	-21.51			peak
12		5212.500	33.54	6.86	40.40	54.00	-13.60			AVG

*:Maximum data x:Over limit !:over margin

(Reference Only)



Dongguan NTC Co., Ltd.
Tel:+86-769-22022444 Fax:+86-769-22022799
Web: [Http://www.ntc-c.com](http://www.ntc-c.com)

Radiated Emission Measurement

File :R40BT Data :#1 Date: 2019/7/8 Time: 21:38:55

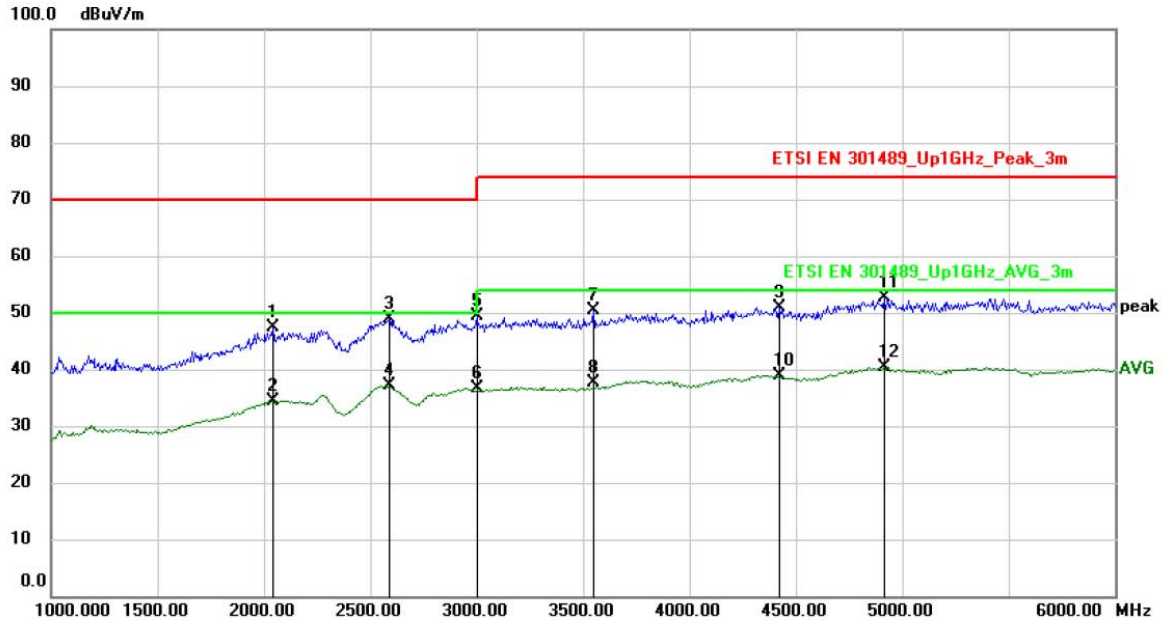

Site: 3m Chamber Polarization: **Vertical** Temperature: 26
Limit: ETSI EN 301489_Up1GHz_Peak_3m Power: AC230V/50Hz Humidity: 47 %
EUT: 2.0 Multimedia Speaker Distance: 3m
M/N: R40BT
Mode: BT Link
Note:

No.	Mk.	Freq. MHz	Reading Level dBuV	Correct Factor dB/m	Measure- ment dBuV/m	Limit dBuV/m	Over dB	Detector	Antenna Height cm	Table Degree degree	Comment
1		2043.750	48.07	-0.75	47.32	70.00	-22.68	peak			
2		2043.750	35.20	-0.75	34.45	50.00	-15.55	AVG			
3		2587.500	48.28	0.70	48.98	70.00	-21.02	peak			
4	*	2587.500	36.42	0.70	37.12	50.00	-12.88	AVG			
5		3000.000	47.46	1.81	49.27	70.00	-20.73	peak			
6		3000.000	34.77	1.81	36.58	50.00	-13.42	AVG			
7		3550.000	47.43	2.85	50.28	74.00	-23.72	peak			
8		3550.000	34.77	2.85	37.62	54.00	-16.38	AVG			
9		4425.000	45.97	4.93	50.90	74.00	-23.10	peak			
10		4425.000	34.06	4.93	38.99	54.00	-15.01	AVG			
11		4918.750	45.98	6.74	52.72	74.00	-21.28	peak			
12		4918.750	33.68	6.74	40.42	54.00	-13.58	AVG			

*:Maximum data x:Over limit !:over margin

(Reference Only)



Dongguan NTC Co., Ltd.
Tel: +86-769-22022444 Fax: +86-769-22022799
Web: [Http://www.ntc-c.com](http://www.ntc-c.com)

Conducted Emission Measurement

File :R40BT Data :#8 Date: 2019/7/6 Time: 10:56:04

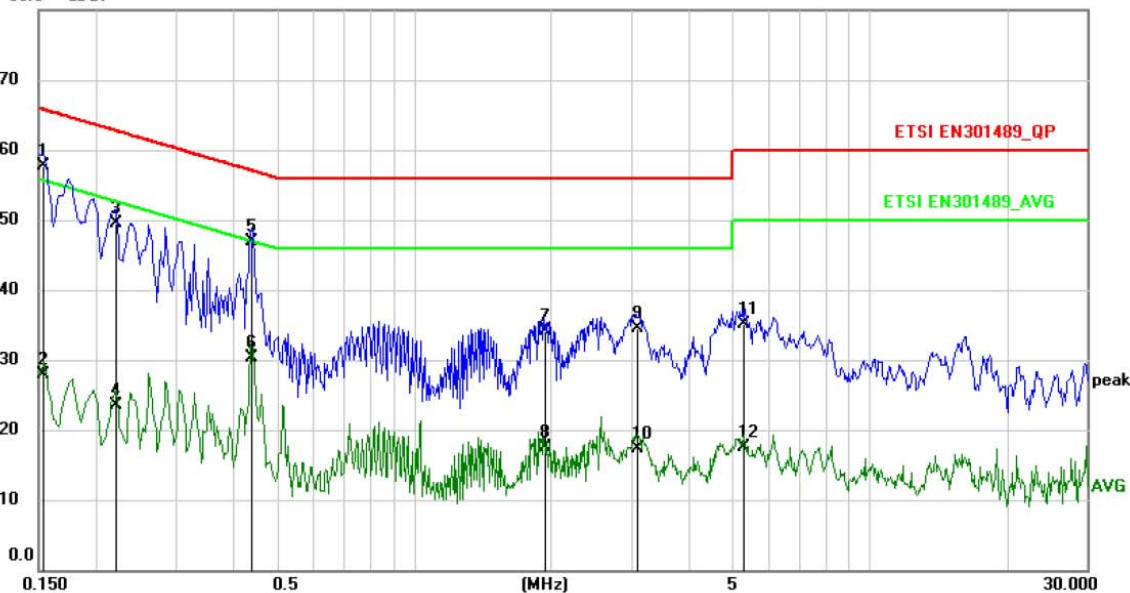

Site: Phase: **L1** Temperature: 26
Limit: ETSI EN301489_QP Power: AC230V/50Hz Humidity: 50 %
EUT: 2.0 Multimedia Speaker
M/N: R40BT
Mode: BT Link
Note:

No.	Mk.	Freq. MHz	Reading Level dBuV	Correct Factor dB	Measure- ment dBuV	Limit dBuV	Over dB	Detector	Comment
1	*	0.1539	47.19	10.61	57.80	65.79	-7.99	QP	
2		0.1539	17.29	10.61	27.90	55.79	-27.89	AVG	
3		0.2220	38.89	10.61	49.50	62.74	-13.24	QP	
4		0.2220	12.99	10.61	23.60	52.74	-29.14	AVG	
5		0.4380	36.28	10.62	46.90	57.10	-10.20	QP	
6		0.4380	19.68	10.62	30.30	47.10	-16.80	AVG	
7		1.9380	23.55	10.65	34.20	56.00	-21.80	QP	
8		1.9380	6.85	10.65	17.50	46.00	-28.50	AVG	
9		3.0860	23.95	10.65	34.60	56.00	-21.40	QP	
10		3.0860	6.75	10.65	17.40	46.00	-28.60	AVG	
11		5.2859	24.54	10.66	35.20	60.00	-24.80	QP	
12		5.2859	6.84	10.66	17.50	50.00	-32.50	AVG	

*:Maximum data x:Over limit !:over margin

(Reference Only)



Dongguan NTC Co., Ltd.
Tel: +86-769-22022444 Fax: +86-769-22022799
Web: [Http://www.ntc-c.com](http://www.ntc-c.com)

Conducted Emission Measurement

File :R40BT Data :#7 Date: 2019/7/6 Time: 10:49:27

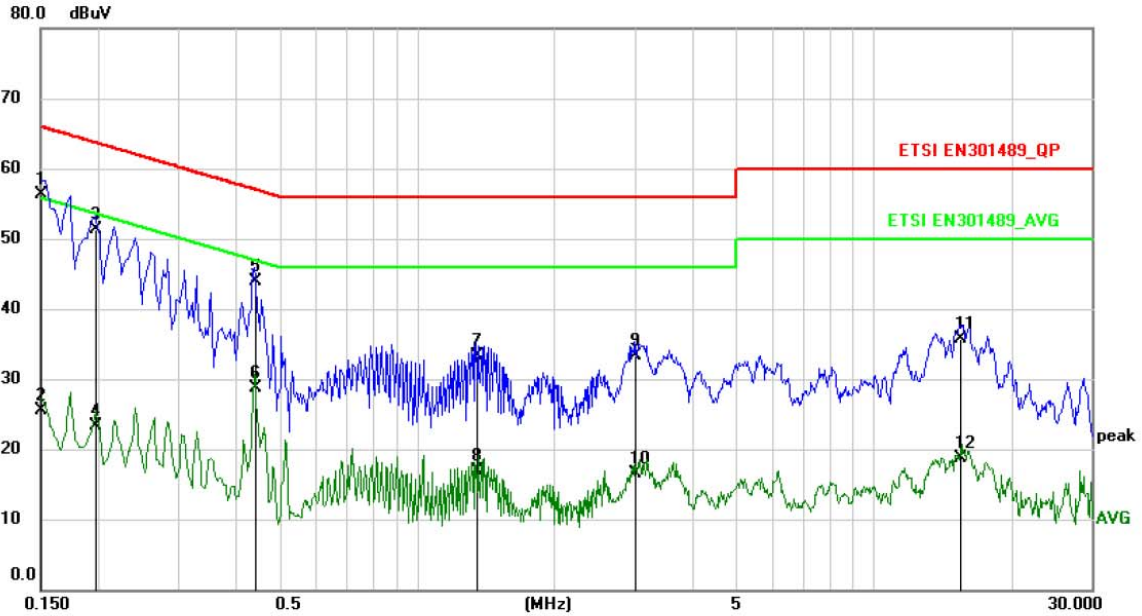

Site: Limit: ETSI EN301489_QP EUT: 2.0 Multimedia Speaker M/N: R40BT Mode: BT Link Note:
Phase: N Temperature: 26 Power: AC230V/50Hz Humidity: 50 %

No.	Mk.	Freq. MHz	Reading Level dBuV	Correct Factor dB	Measurement dBuV	Limit dBuV	Over dB	Detector	Comment
1	*	0.1500	45.69	10.61	56.30	66.00	-9.70	QP	
2		0.1500	14.89	10.61	25.50	56.00	-30.50	AVG	
3		0.1980	40.69	10.61	51.30	63.69	-12.39	QP	
4		0.1980	12.79	10.61	23.40	53.69	-30.29	AVG	
5		0.4420	33.28	10.62	43.90	57.02	-13.12	QP	
6		0.4420	18.08	10.62	28.70	47.02	-18.32	AVG	
7		1.3460	22.75	10.65	33.40	56.00	-22.60	QP	
8		1.3460	6.35	10.65	17.00	46.00	-29.00	AVG	
9		2.9980	22.65	10.65	33.30	56.00	-22.70	QP	
10		2.9980	5.85	10.65	16.50	46.00	-29.50	AVG	
11		15.4179	25.13	10.67	35.80	60.00	-24.20	QP	
12		15.4179	8.13	10.67	18.80	50.00	-31.20	AVG	

*:Maximum data x:Over limit !:over margin

(Reference Only)

8.3 AC MAINS HARMONIC CURRENT EMISSION

LIMIT

Please refer to EN 61000-3-2

TEST CONFIGURATION

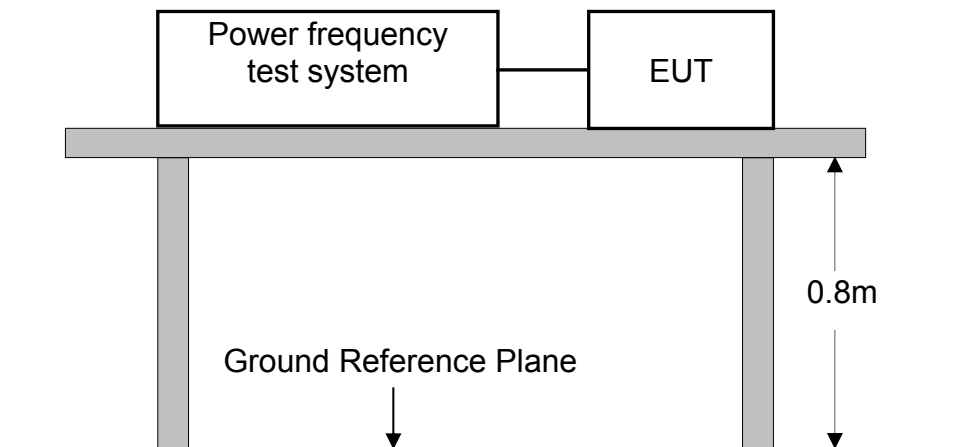

Ambient Condition of the Test Site			
Temperature	22°C	Test Voltage	AC 230V/50Hz
Humidity	49%RH	Tested by	Sance
Pressure	1022mbar		

TEST PROCEDURE

Please refer to EN 61000-3-2 for the measurement methods.

TEST RESULTS

Pass

Test Mode: BT Link

According to clause 7 of EN 61000-3-2, equipment with a rated power of 75W or less, no limits apply. It is considered to meet the requirements of the standard.

8.4 AC MAINS VOLTAGE FLUCTUATION AND FLICKER

LIMIT

Please refer to EN 61000-3-3

TEST CONFIGURATION

(Same as the configuration of the AC MAINS HARMONIC CURRENT EMISSIONS TEST)

Ambient Condition of the Test Site			
Temperature	22°C	Test Voltage	AC 230V/50Hz
Humidity	49%RH	Tested by	Sance
Pressure	1022mbar		

TEST PROCEDURE

Please refer to EN 61000-3-3 for the measurement methods.

TEST RESULTS

Pass

Test Mode: BT Link

Flicker Test Summary per EN/IEC61000-3-3 Ed. 3.0 (2013) (Run time)

EUT: 2.0 Multimedia Speaker
 Test category: All parameters (European limits)
 Test date: 2019/7/9
 Test duration (min): 10
 Comment: BT Link
 Customer: FENDA
 M/N: R40BT
 Test Result: Pass

Tested by: Sean
 Test Margin: 100
 Start time: 9:51:20 End time: 10:01:41
 Data file name: F-000098.cts_data

Status: Test Completed

Psti and limit line

European Limits

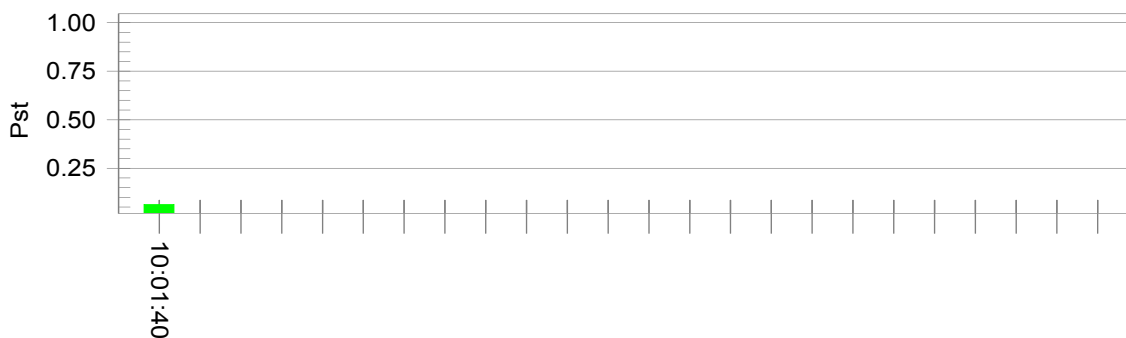

Plt and limit line

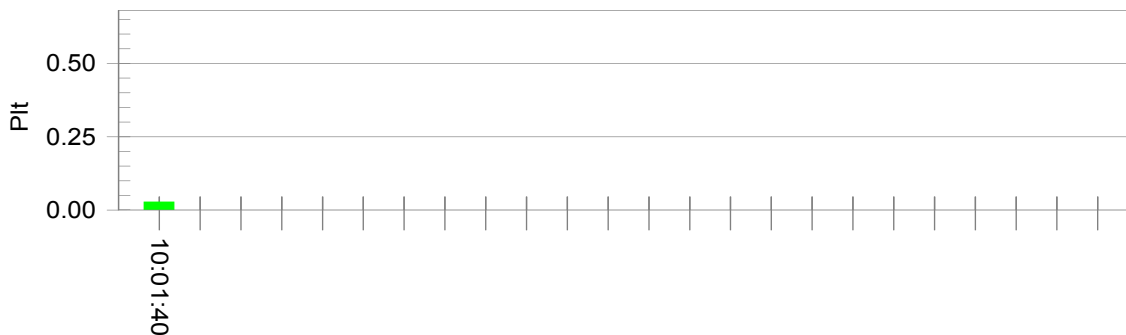

Parameter values recorded during the test:

Vrms at the end of test (Volt):	230.50		
Highest dt (%):	0.00	Test limit (%):	3.30 Pass
Time(mS) > dt:	0.0	Test limit (mS):	500.0 Pass
Highest dc (%):	0.00	Test limit (%):	3.30 Pass
Highest dmax (%):	0.00	Test limit (%):	4.00 Pass
Highest Pst (10 min. period):	0.064	Test limit:	1.000 Pass
Highest Plt (2 hr. period):	0.028	Test limit:	0.650 Pass

8.5 ELECTROSTATIC DISCHARGE

TEST CONFIGURATION

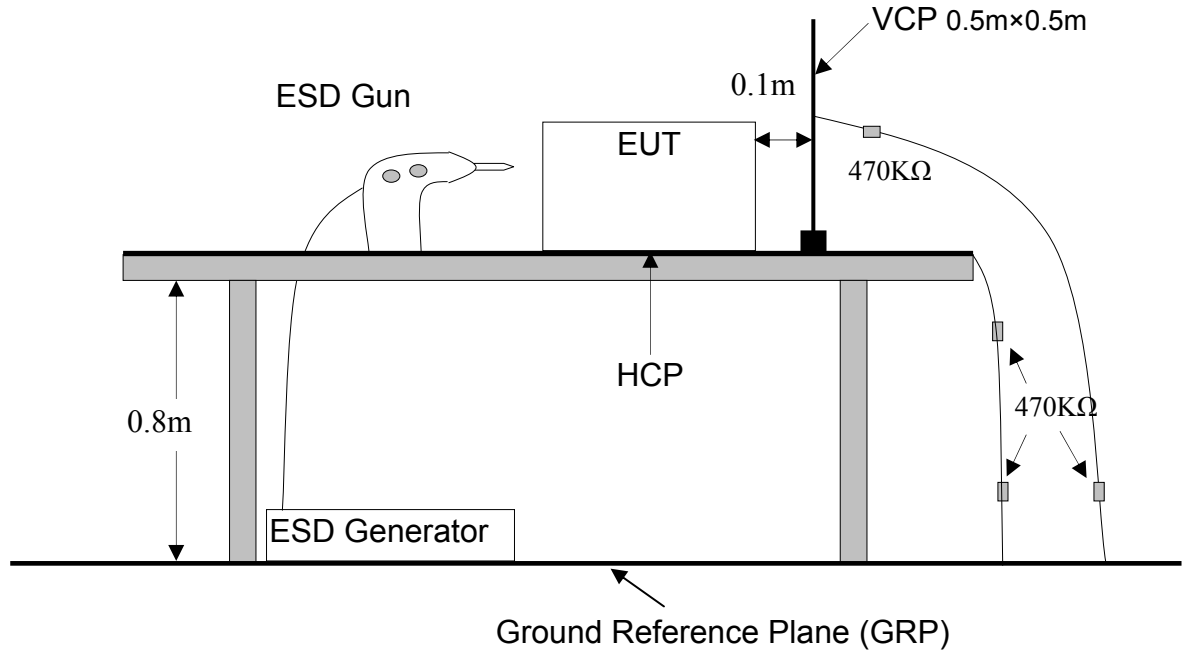

TEST PROCEDURE:

Please refer to Draft ETSI EN 301 489-1 V2.2.1 Clause 9.3.2 and EN 61000-4-2 for the measurement methods.

TEST RESULT

PASS

Please refer to following data table.

Test Condition								
Ambient Condition:		Temp.: 25°C		R.H.: 50 %		Air Pressure: 101 kPa		
Power Supply:		AC 230V 50Hz,						
Tested mode:		BT Link						
Ground Bond Resistance: 0.2 Ω								
Required Performance Criterion: CR & CT & B								
Direct Discharge								
-	Air discharge (KV)				Contact discharge (KV)			
Test Point	±2	±4	±6	±8	±2	±4	-	-
1	A	A	A	A	A	A	-	-
2	B	B	B	B	B	B	-	-
3	A	A	A	A	A	A	-	-
Indirect Discharge								
-	HCP (KV)				VCP (KV)			
Test Point	±2	±4	-	-	±2	±4	-	-
Front	A	A	-	-	A	A	-	-
Left	A	A	-	-	A	A	-	-
Right	A	A	-	-	A	A	-	-
Back	A	A	-	-	A	A	-	-
Test result					PASS			
<p>Note: The EUT stop working during the test, but it can be resumed to normal operation by user after test. After consider with client's confirmation that relevant instruction will be mentioned in the manual, so the test result was considered to be passed. Test</p> <p style="text-align: right;">Engineer : Alvin</p>								

Electrostatic discharge immunity test- Appendix I

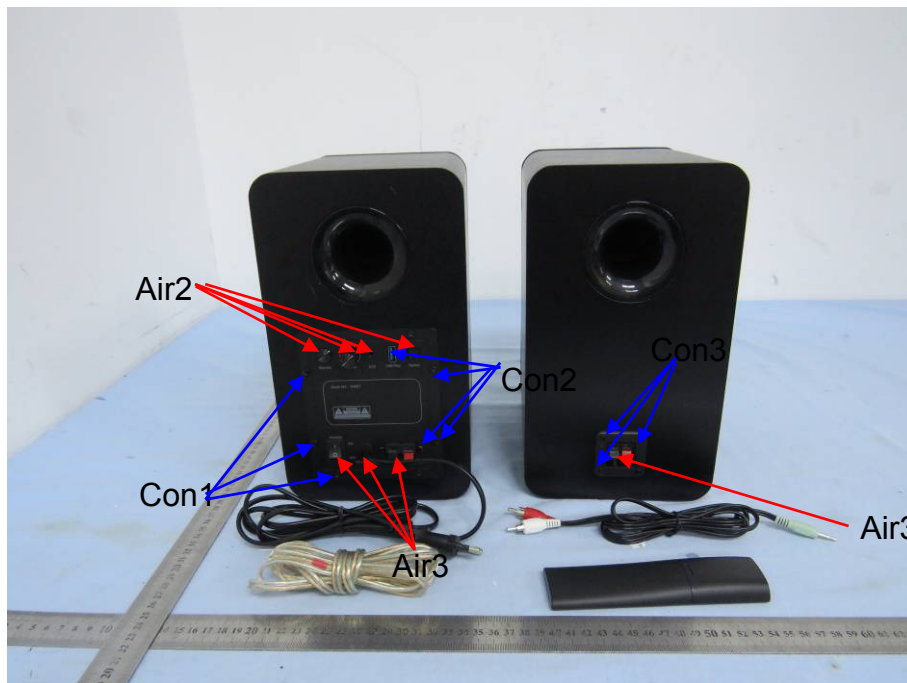
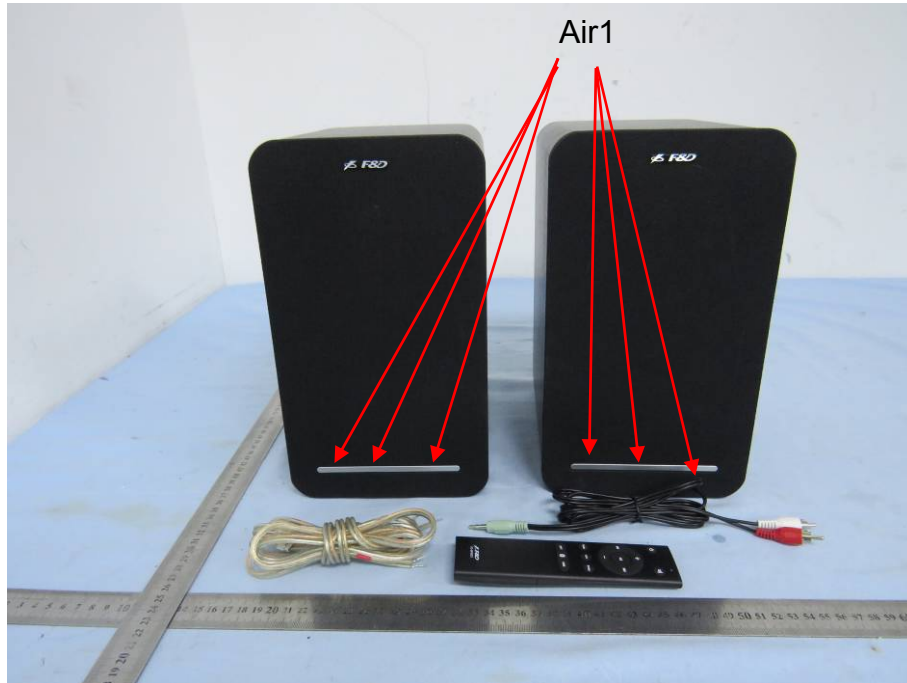

8.6 RF ELECTROMAGNETIC FIELD

TEST CONFIGURATION

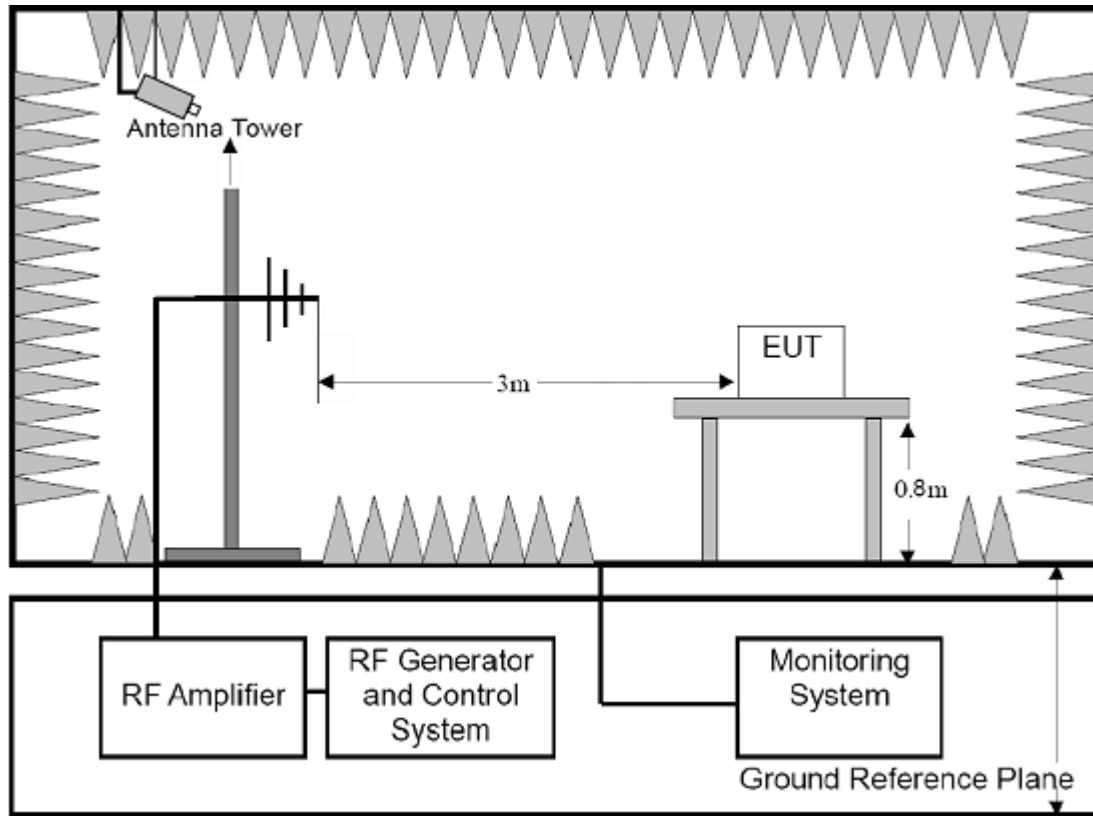

TEST PROCEDURE

Please refer to Draft ETSI EN 301 489-1 V2.2.1 Clause 9.2.2 and EN61000-4-3 for the measurement methods.

TEST RESULT

PASS

Please refer to following data table.

Test Condition			
Temperature	25°C	Test Voltage	AC 230V/50Hz
Humidity	50%RH	Tested by	Sean
Pressure	1010mbar	Performance Criterion	CR & CT & A
Frequency Range		80-6000 MHz	
Test Modulation		1kHz, 80% AM	
Dwell time		1 second	
Frequency Step		1%	
Antenna Polarization		Horizontal and Vertical	
Test Mode		BT Link	
Test Level		3V/m	
Test Result			
Frequency (MHz)	Exposed Side		Result
80 to 6000	Front		Pass
80 to 6000	Left		Pass
80 to 6000	Rear		Pass
80 to 6000	Right		Pass

Note: 1. The exclusion band for 2,40 GHZ equipment falling within the scope of the present document extends from 2 280 MHz to 2 603,50 MHz.
 2. During the test, the EUT did not show any abnormality.

8.7 AC MAINS FAST TRANSIENTS COMMON MODE

TEST CONFIGURATION

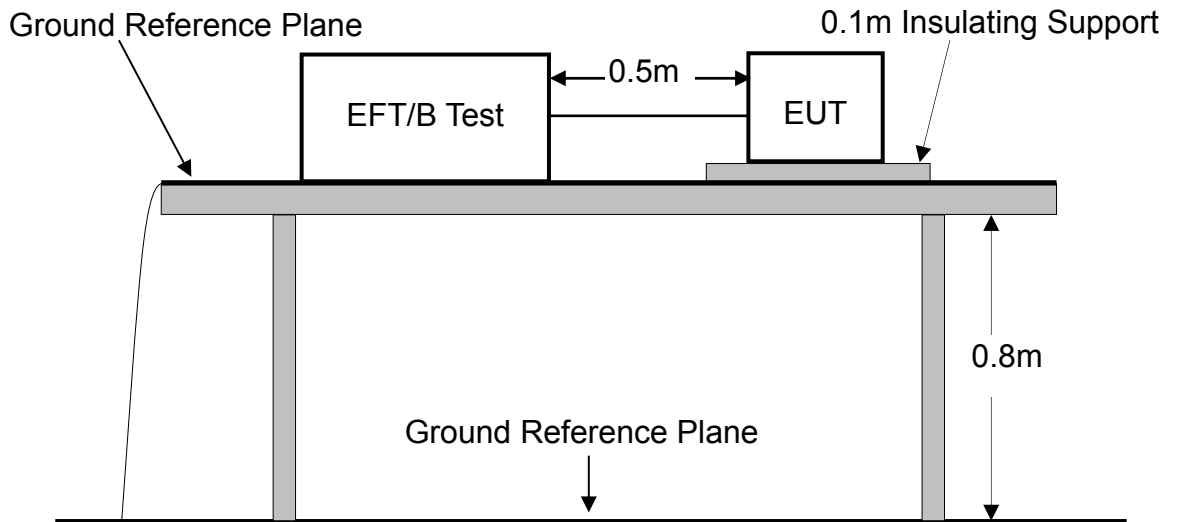

TEST PROCEDURE

Please refer to Draft ETSI EN 301 489-1 V2.2.1 Clause 9.4.2 and EN 61000-4-4 for the measurement methods.

TEST RESULT

PASS

Please refer to following data table.

Test Condition			
Temperature	25°C	Test Voltage	AC 230V/50Hz
Humidity	50%RH	Tested by	Loki
Pressure	1010mbar	Performance Criterion	CR & CT & B
Impulse Frequency		5kHz	
Tr/Th		5/50ns	
Burst Duration		15ms	
Burst Period		300ms	
Port		AC Power	
Test Mode		BT Link	
Test Level		±1.0kV	
Test Result			
Injection Line	Level	Result	
Line	±1.0kV	Pass	
Neutral	±1.0kV	Pass	
PE	-	-	
Line + Neutral	±1.0kV	Pass	
Line + PE	-	-	
Neutral + PE	-	-	
DC Power Line	-	-	
Signal Line	-	-	

Note: During the test, the EUT did not show any abnormality.

8.8 AC MAINS SURGE

TEST CONFIGURATION

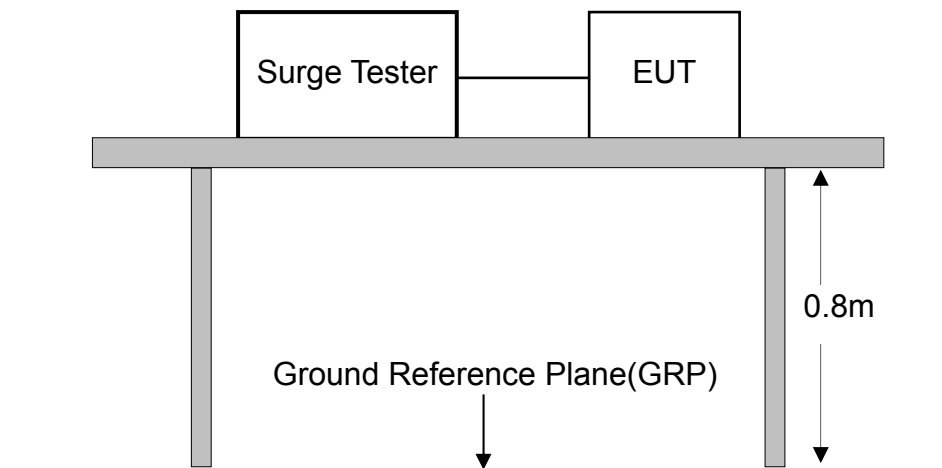

TEST PROCEDURE:

Please refer to Draft ETSI EN 301 489-1 V2.2.1 Clause 9.8.2 and EN 61000-4-5 for the measurement methods.

TEST RESULT

PASS

Please refer to following data table.

Test Condition			
Temperature	25°C	Test Voltage	AC 230V/50Hz
Humidity	50%RH	Tested by	Loki
Pressure	1010mbar	Performance Criterion	CR & CT & B
Voltage Waveform		1.2/50 us	
Current Waveform		8/20 us	
Polarity		Positive/Negative	
Phase angle		0°, 90°, 180 °, 270°	
Repetition Rate		1 minute	
Test Mode		BT Link	
Test Level		±1.0kV / 5 Positive And 5 Negative Surges	
Test Result			
Coupling Line	Level	Result	
Line + Neutral	±1.0kV	Pass	
Line + PE	-	-	
Neutral + PE	-	-	
T, R-Ground	-	-	
L1, 2, 3, 4-G (LAN)	-	-	

Note: During the test, the EUT did not show any abnormality.

8.9 RADIO FREQUENCY COMMON MODE

TEST CONFIGURATION

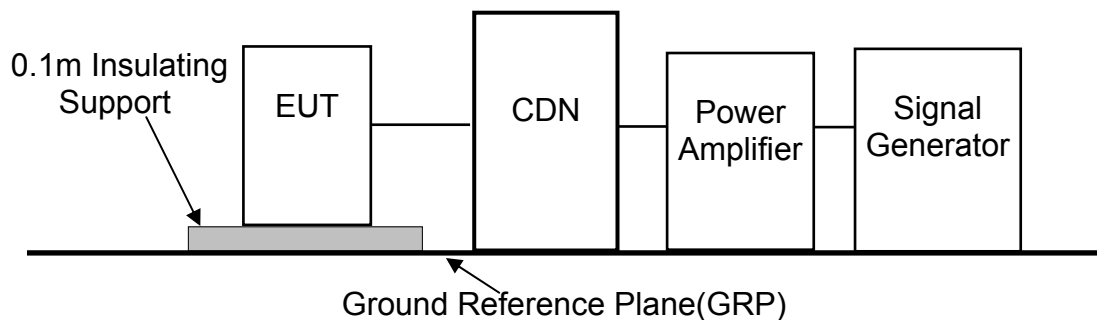

TEST PROCEDURE

Please refer to Draft ETSI EN 301 489-1 V2.2.1 Clause 9.5.2, EN61000-4-6 for the measurement methods.

TEST RESULT

PASS

Please refer to following data table.

Test Condition			
Temperature	25°C	Test Voltage	AC 230V/50Hz
Humidity	50%RH	Tested by	Sean
Pressure	1010mbar	Performance Criterion	CR & CT & A
Frequency Range		0.15MHz~80MHz	
Frequency Step		1%	
Dwell time		1s	
Test Modulation		1 kHz, 80% AM	
Source Impedance		150Ω	
Test Mode		BT Link	
Test Level		3V(r.m.s)	
Test Result			
Injection Line	Level		Result
AC Power Line	3V(r.m.s)		Pass
Telecommunication Line	-		-
DC Line	-		-
Signal Line	-		-
Control Line	-		-

Note: During the test, the EUT did not show any abnormality.

8.10 VOLTAGE DIPS AND INTERRUPTION

TEST CONFIGURATION

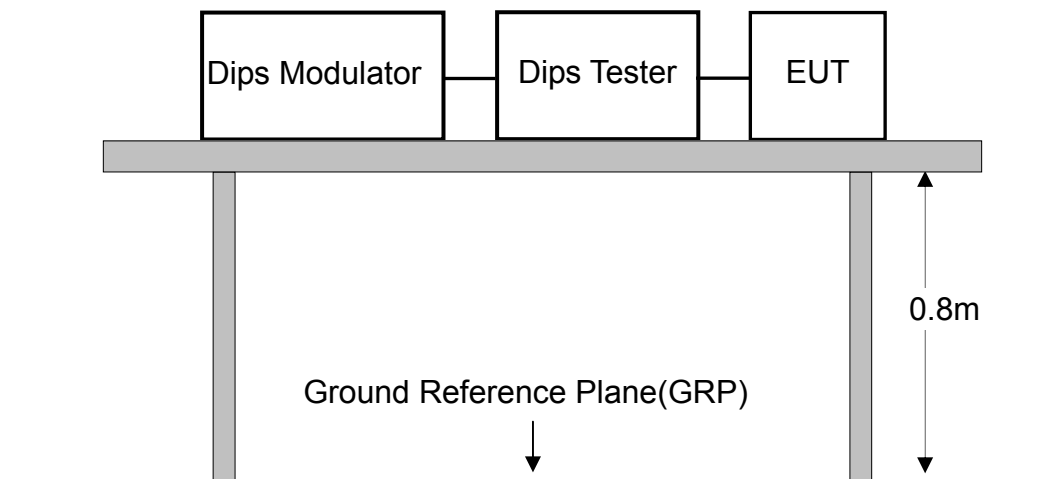

TEST PROCEDURE

Please refer to Draft ETSI EN 301 489-1 V2.2.1 Clause 9.7.2 and EN 61000-4-11 for the measurement methods.

TEST RESULT

PASS

Please refer to following data table.

Test Condition				
Temperature	25°C	Test Voltage	AC 230V 50Hz	
Humidity	50%RH	Tested by	Loki	
Pressure	1010mbar	Performance Criterion	B&C	
Phase angles		0°, 45°, 90°, 135°, 180°, 225°, 270°, 315°		
Number of Dips/Interruptions :		3 times		
Repetition Rate		10s		
Test Mode		BT Link		
Test Level				
	Test Level (% U _T)	Reduction (%)	Duration (ms)	Criterion
Voltage Dips	70	30%	500	B
	0	100%	20	B
	0	100%	10	B
Voltage Interruption	0	100%	5000	C
Test Result				
	Test Level (% U _T)	Reduction (%)	Duration (ms)	Result
	70	30%	500	Pass
	0	100%	20	Pass
	0	100%	10	Pass
	0	100%	5000	Pass*

Note*: During the test, the EUT power off, but it can be recovered by user after test.

8.11 TEST EQUIPMENT LIST

FOR MAINS TERMINALS DISTURBANCE VOLTAGE TEST

Item	Equipment	Manufacturer	Model No.	Serial No.	Last Cal.	Cal. Interval
1.	Test Receiver	Rohde & Schwarz	ESCI	101152	Mar. 14, 2019	1 Year
2.	L.I.S.N	Rohde & Schwarz	ENV 216	101317	Mar. 14, 2019	1 Year
3.	L.I.S.N	Rohde & Schwarz	ESH2-Z5	893606/014	Mar. 14, 2019	1 Year
4.	RF Switching Unit	Compliance Direction Systems Inc.	RSU-M2	38311	Mar.14, 2019	1 Year
5.	Test Software	EZ	EZ EMC	N/A	N/A	N/A

FOR RADIATED EMISSION MEASUREMENT

Item	Equipment	Manufacturer	Model No.	Serial No.	Last Cal.	Cal. Interval
1.	Test Receiver	Rohde & Schwarz	ESCI7	100837	Mar. 14, 2019	1 Year
2.	Antenna	Schwarzbeck	VULB9162	9162-010	Mar. 23, 2019	1 Year
3.	Positioning Controller	UC	UC 3000	N/A	N/A	N/A
4.	Color Monitor	SUNSP0	SP-140A	N/A	N/A	N/A
5.	Single Phase Power Line Filter	SAEMC	PF201A-32	110210	N/A	N/A
6.	3 Phase Power Line Filter	SAEMC	PF401A-200	110318	N/A	N/A
7.	DC Power Filter	SAEMC	PF301A-200	110245	N/A	N/A
8.	Spectrum Analyzer	Rohde & Schwarz	FSU26	200409/026	Mar. 14, 2019	1 Year
9.	Horn Antenna	COM-Power	AH-118	071078	Mar. 23, 2019	1 Year
10.	Loop Antenna	Schwarzbeck	FMZB 1513	1513-272	Apr. 24, 2019	1 Year
11.	Pre-Amplifier	HP	HP 8449B	3008A00964	Mar. 14, 2019	1 Year
12.	Pre-Amplifier	HP	HP 8447D	1145A00203	Mar. 14, 2019	1 Year
13.	Test Software	EZ	EZ EMC	N/A	N/A	N/A

FOR HARMONIC / FLICKER MEASUREMENT

Item	Equipment	Manufacturer	Model No.	Serial No.	Last Cal.	Cal. Interval
1.	Power Frequency Analyser	California Instruments	PACS-1	72846	Mar. 14, 2019	1 Year
2.	5KVA AC Power Source	California Instruments	500liX	60137	Mar. 14, 2019	1 Year
3.	Software	California Instruments	CTS30	N/A	N/A	N/A

FOR ELECTROSTATIC DISCHARGE TEST

Item	Equipment	Manufacturer	Model No.	Serial No.	Last Cal.	Cal. Interval
1.	ESD Tester	TESEQ	NSG 437	432	Mar. 23, 2019	1 Year

FOR RF ELECTROMAGNETIC FIELD IMMUNITY TEST

Item	Equipment	Manufacturer	Model No.	Serial No.	Last Cal.	Cal. Interval
1.	Signal Generator	Agilent	N5181A	MY470701 60	Apr. 24, 2019	1 Year
2.	RF Switch	SKET	N/A	N/A	N/A	N/A
3.	Power Amplifier	SKET	HAP801000 M_250W	201804008	N/A	N/A
4.	Power Amplifier	SKET	HAP0103G 75W	201804009	N/A	N/A
5.	Power Amplifier	SKET	HAP0306G 50W	201804010	N/A	N/A
6.	Power Meter	Agilent	E4419B	GB402014 69	Apr.24,2019	1 Year
7.	Power Sensor	Agilent	E9300A	MY414989 19	Apr.24,2019	1 Year
8.	Power Sensor	Agilent	E9300A	US392112 59	Apr.24,2019	1 Year
9.	E-Field Probe	Narda	EP-601	N/A	Apr.24,2019	1 Year
10.	Antenna	Schwarzbeck	STLP 9129	9129071	Apr.24,2018	2 Year
11.	Audio Analyzer	Rohde & Schwarz	UPV	100894	Mar. 23, 2019	1 Year
12.	Chamber	Chengyu	7*5*3.5m	N/A	Mar.26,2018	2 Year
13.	Test Software	SKET	SKIT_RS	N/A	N/A	N/A

FOR ELECTRICAL FAST TRANSIENT /BURST IMMUNITY TEST

Item	Equipment	Manufacturer	Model No.	Serial No.	Last Cal.	Cal. Interval
1.	Burst Tester	EM TEST	UCS 500N	V1104108683	Mar. 14, 2019	1 Year
2.	Coupling Clamp	EM TEST	HFK	0311-94	Mar. 14, 2019	1 Year
3.	Test Soft	EM TEST	lec. control	N/A	N/A	N/A

FOR SURGE IMMUNITY TEST

Item	Equipment	Manufacturer	Model No.	Serial No.	Last Cal.	Cal. Interval
1.	Surge Tester	EM TEST	UCS 500N	V1104108683	Mar. 14, 2019	1 Year
2.	Test Soft	EM TEST	lec. control	N/A	N/A	N/A

FOR INJECTED CURRENTS IMMUNITY MEASUREMENT

Item	Equipment	Manufacturer	Model No.	Serial No.	Last Cal.	Cal. Interval
1.	Signal Generator	IFR	2023A	N/A	Mar. 14, 2019	1 Year
2.	Power Amplifier	SCHAFFNER	CBA9425	1022	Mar. 14, 2019	1 Year
3.	6dB 50Watt Attenuator	SCHAFFNER	ATN6025	N/A	Mar. 14, 2019	1 Year
4.	CDN	Lioncel	CDN-M3-16	0170708	Mar. 14, 2019	1 Year
5.	CDN	Lioncel	CDN-M2-16	0170723	Mar. 14, 2019	1 Year
6.	Directional Coupler	SCHAFFNER	255	19184	Mar. 14, 201	1 Year
7.	Dips Modulator	EM TEST	V4780S2	0111-11	Mar. 14, 2019	1 Year
8.	Audio Analyzer	Rohde & Schwarz	UPV	100894	Mar. 23, 2019	1 Year
9.	Test Software	EZ	EZ_CS	N/A	N/A	N/A

FOR VOLTAGE DIPS AND INTERRUPTIONS MEASUREMENT

Item	Equipment	Manufacturer	Model No.	Serial No.	Last Cal.	Cal. Interval
1.	Dips Tester	EM TEST	UCS500N	V1104108683	Mar. 14, 2019	1 Year
2.	Test Soft	EM TEST	lec.control	N/A	N/A	N/A
3.	Dips Modulator	EM TEST	V4780S2	0111-11	Mar. 14, 2019	1 Year

APPENDIX 1 PHOTOGRPHS OF TEST SETUP

RADIATED EMISSION TEST

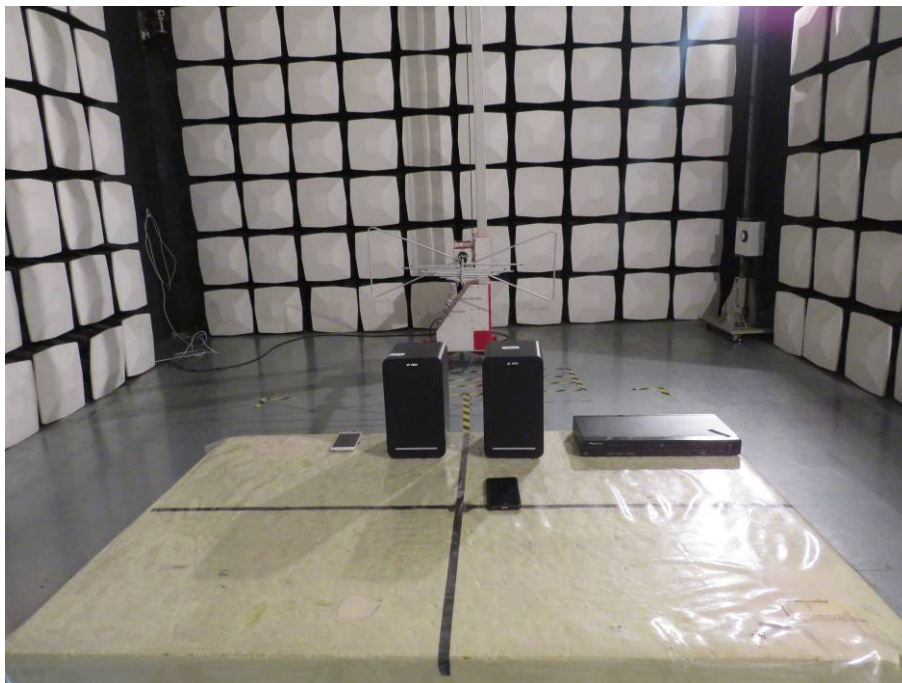

LINE CONDUCTED EMISSION TEST



POWER HARMONIC & VOLTAGE FLUCTUATION / FLICKER TEST



ELECTROSTATIC DISCHARGE TEST



RADIATED ELECTROMAGNETIC FIELD TEST



ELECTRICAL FAST TRANSIENTS/BURST/ SURGE/ VOLTAGE DIPS TEST



RADIO FREQUENCY COMMON MODE TEST



General Appearance of the E.U.T.





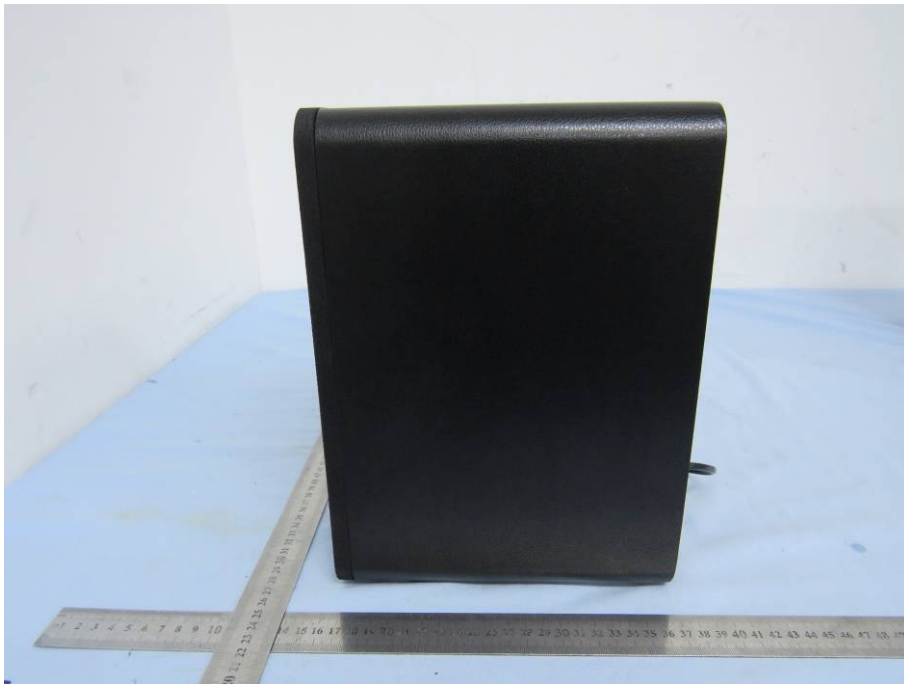



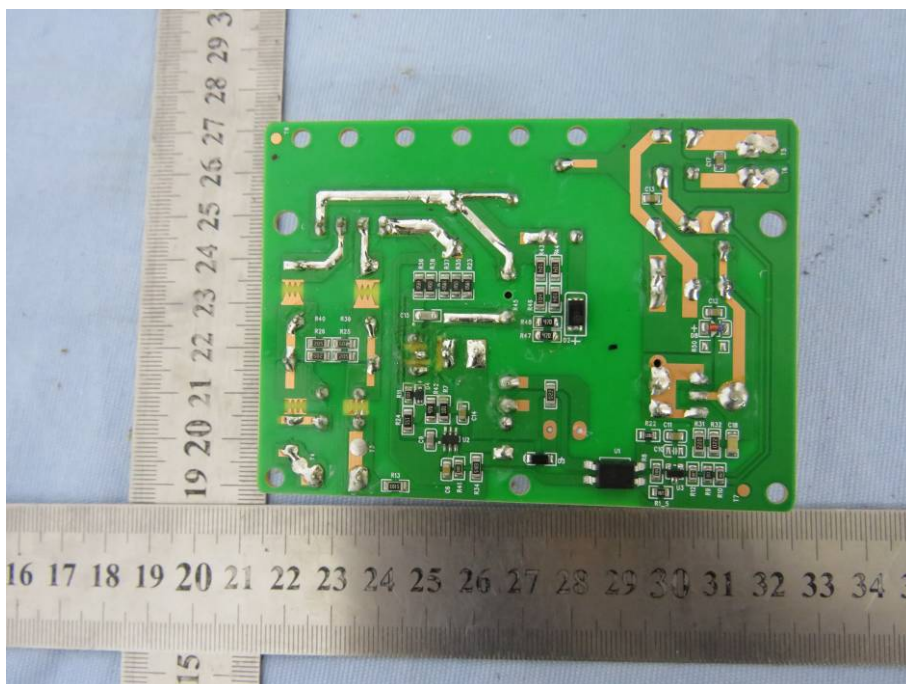
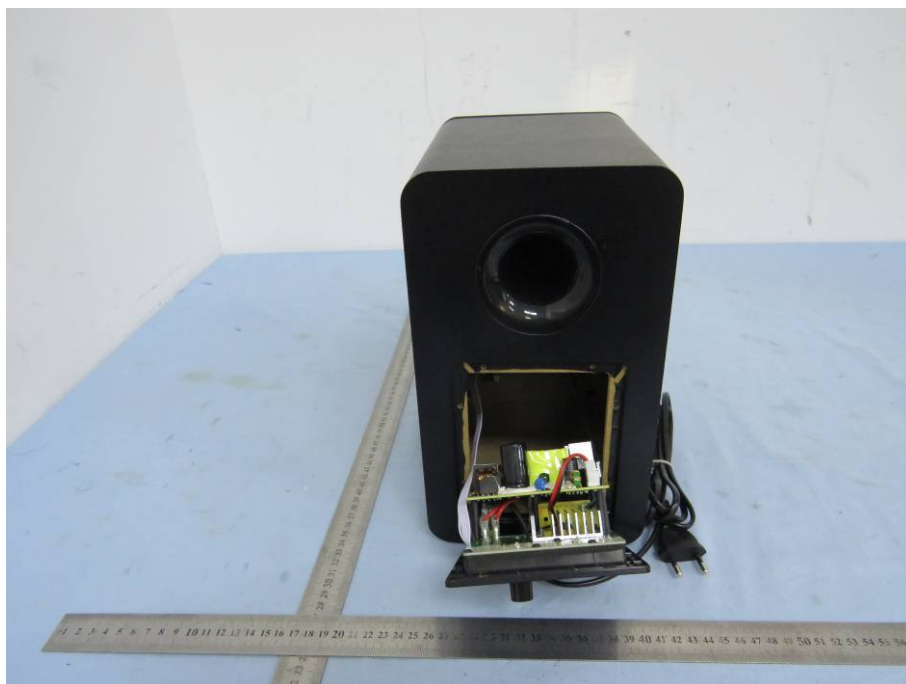

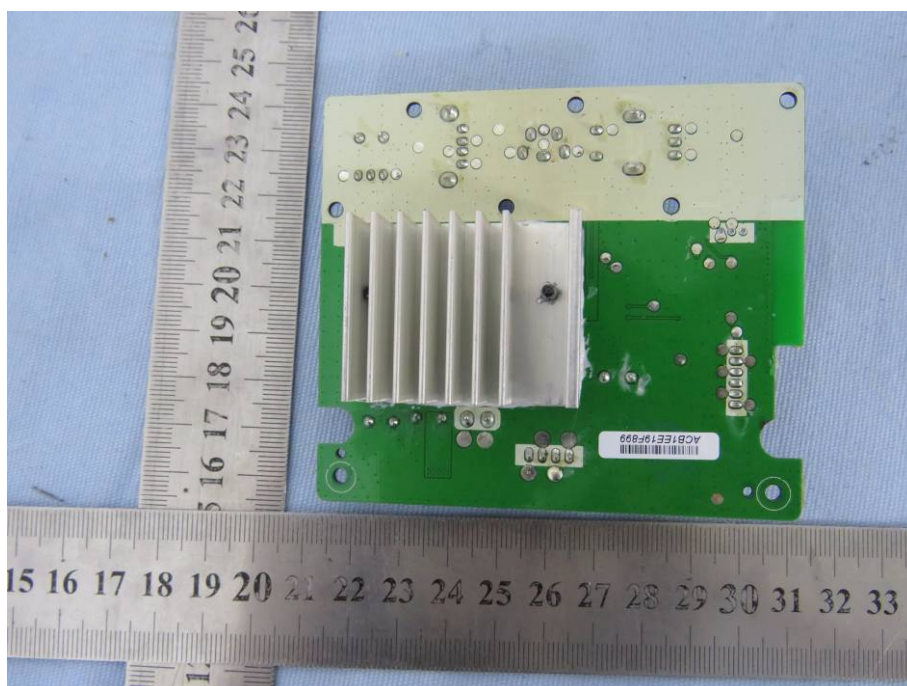
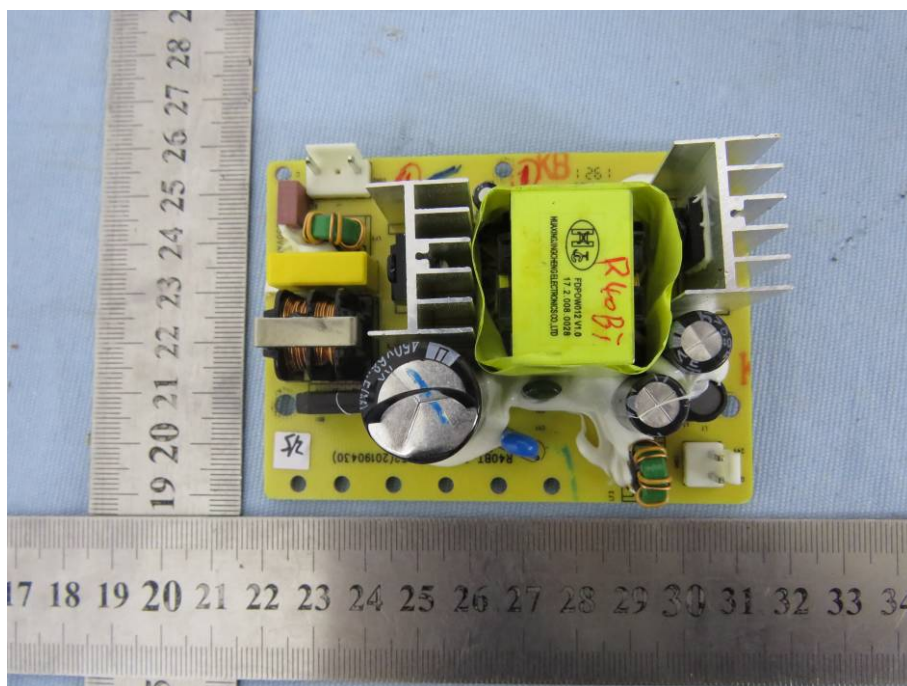

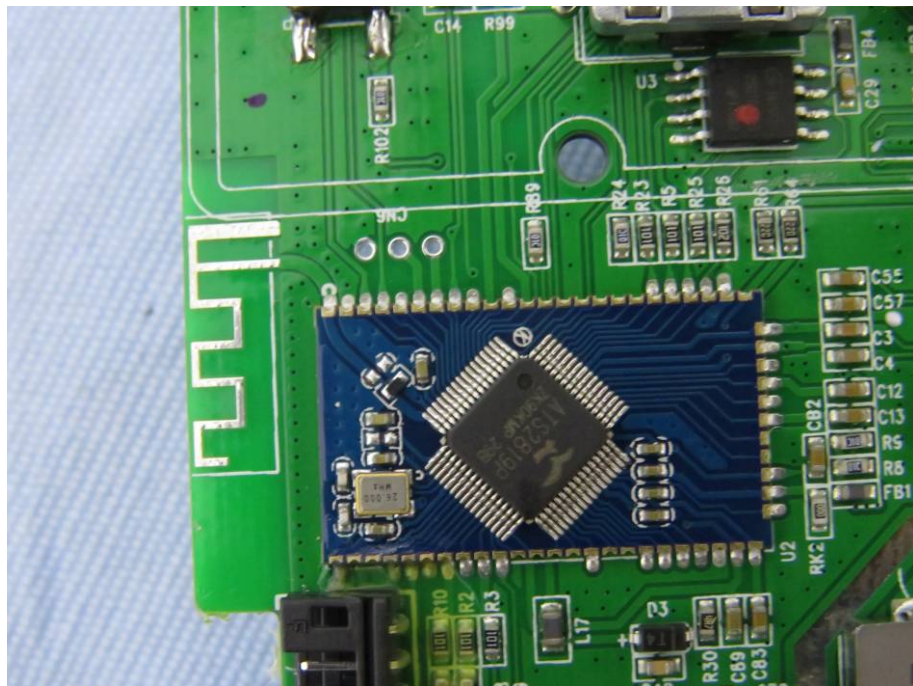
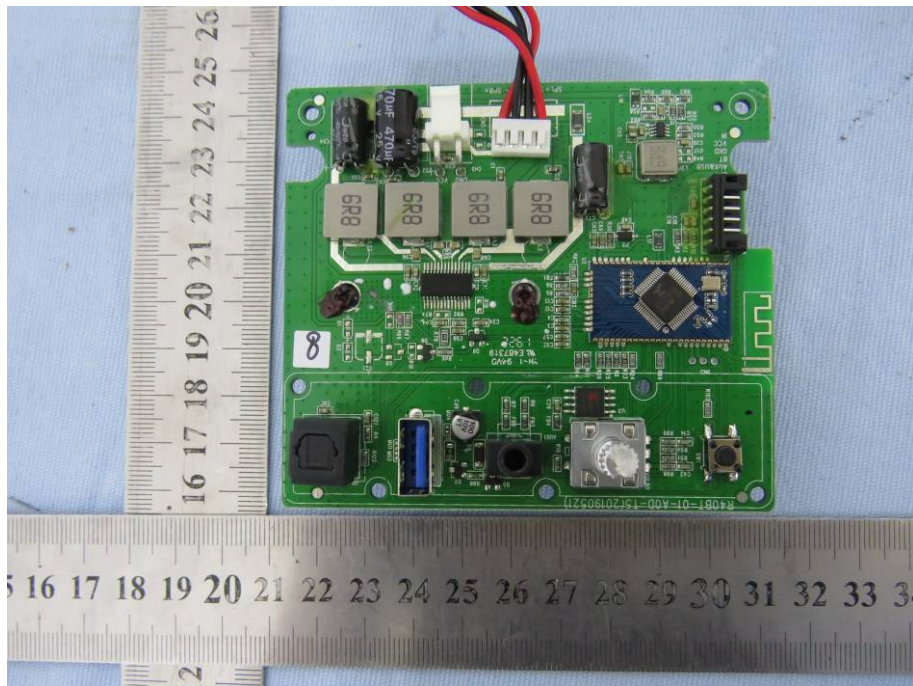

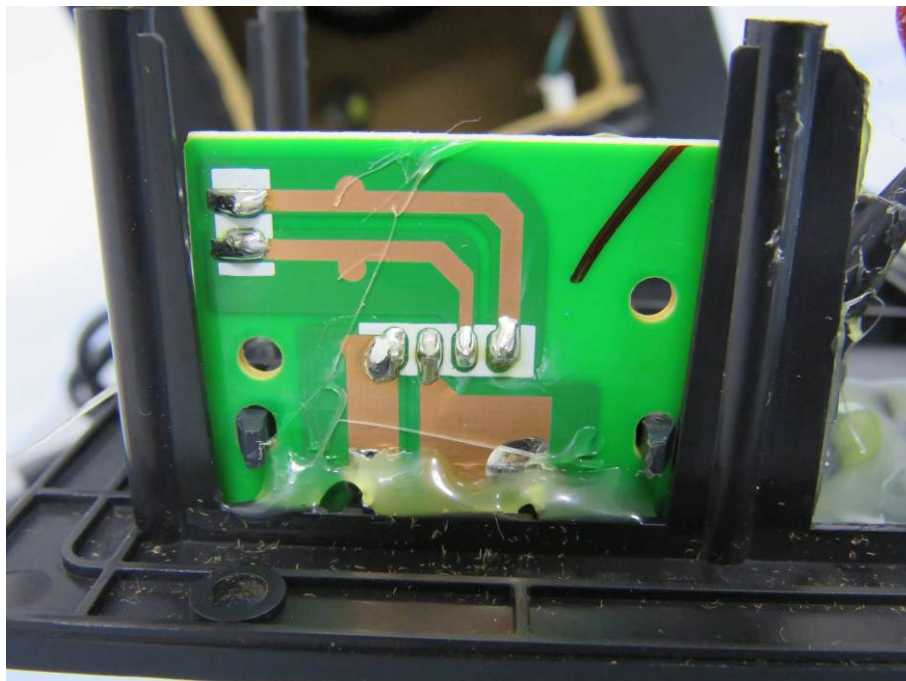
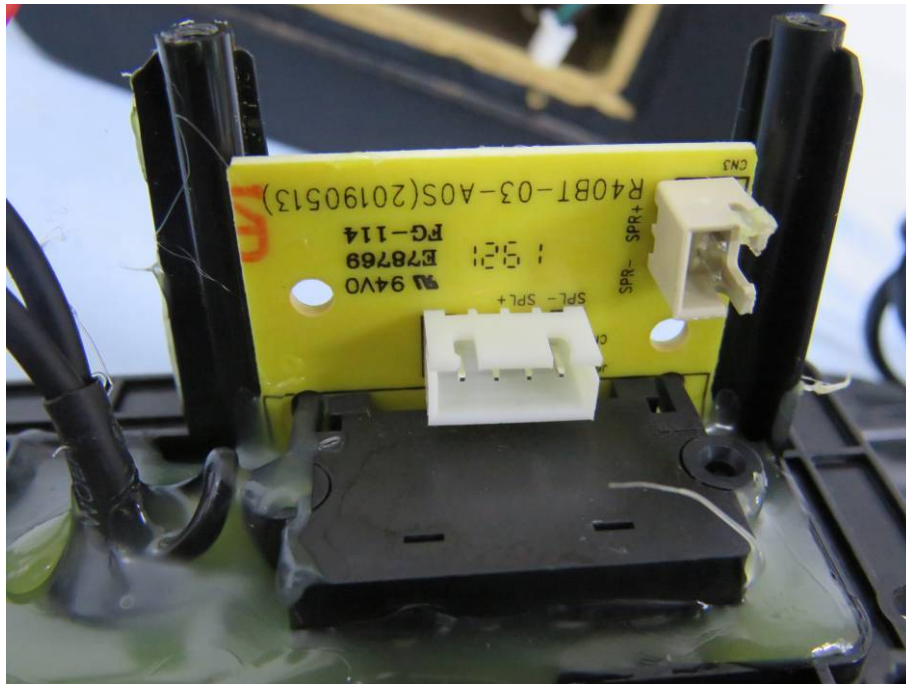

---End---