







**Shenzhen Global Test Service Co.,Ltd.**  
 No.7-101 and 8A-104, Building 7 and 8, DCC Cultural and Creative  
 Garden, No.98, Pingxin North Road, Shangmugu Community,  
 Pinghu Street, Longgang District, Shenzhen, Guangdong

<b>TEST REPORT</b>	
<b>EN 55032</b>	
<b>Electromagnetic compatibility of multimedia equipment - Emission Requirements</b>	
<b>EN 55035</b>	
<b>Information technology equipment – Immunity characteristics – Limits and methods of measurement</b>	
Report Reference No.....	<b>GTS20230203015-1-13</b>
Date of issue.....	May.25, 2023
<b>Testing Laboratory Name .....</b>	<b>Shenzhen Global Test Service Co.,Ltd.</b>
Address.....	No.7-101 and 8A-104, Building 7 and 8, DCC Cultural and Creative Garden, No.98, Pingxin North Road, Shangmugu Community, Pinghu Street, Longgang District, Shenzhen, Guangdong
Compiled by ( position+printed name+signature):	File administrators Peter Xiao 
Supervised by ( position+printed name+signature):	Test Engineer Jenny Zeng 
Approved by ( position+printed name+signature):	Manager Jason Hu 
	
<b>Applicant's name .....</b>	<b>METAVISIO</b>
Address.....	80/84 ROUTE DE LA LIBERATION 77340 PONTAULT COMBAULT France
<b>Test specification:</b>	
Standard .....	<b>EN 55032:2015/A11:2020</b> <b>EN 55035:2017/A11:2020</b> <b>EN IEC 61000-3-2:2019/A1:2021</b> <b>EN 61000-3-3:2013/A2:2021/AC:2022-01</b>
<b>Receiver Date .....</b>	May. 06, 2023
<b>Test Period .....</b>	May. 06, 2023 - May. 24, 2023
<b>Test item description.....</b>	<b>Tablet</b>
Trade Mark.....	THOMSON
Model/Type reference.....	TEO8M2BK32LTE
Listed Models .....	TEO8M, TEO8M2BL32LTE, TEO8M2SL32LTE, TEO8M2T32LTE, TEO8M4BK64LTE, TEO8M4BL64LTE, TEO8M4SL64LTE, TEO8M4T64LTE, TEO8M2BK16LTE, TEO8M2BL16LTE, TEO8M2SL16LTE, TEO8M2T16LTE
Ratings.....	DC 3.7V by battery Recharged by DC 5.0V
Result.....	<b>PASS</b>
<b>Shenzhen Global Test Service Co., Ltd. All rights reserved.</b>	
This publication may be reproduced in whole or in part for non-commercial purposes as long as the Shenzhen Global Test Service Co., Ltd. is acknowledged as copyright owner and source of the material. Shenzhen Global Test Service Co., Ltd. takes no responsibility for and will not assume liability for damages resulting from the reader's interpretation of the reproduced material due to its placement and context.	

# TEST REPORT

<b>Test Report No. :</b> <b>GTS20230203015-1-13</b>	May.25, 2023 Date of issue
---	-------------------------------

Equipment under Test            :        Tablet

Model /Type                        :        TEO8M2BK32LTE

Listed model                        :        TEO8M, TEO8M2BL32LTE, TEO8M2SL32LTE, TEO8M2T32LTE,  
TEO8M4BK64LTE, TEO8M4BL64LTE, TEO8M4SL64LTE,  
TEO8M4T64LTE, TEO8M2BK16LTE, TEO8M2BL16LTE,  
TEO8M2SL16LTE, TEO8M2T16LTE

**Applicant**                         :        **METAVISIO**

Address                                :        80/84 ROUTE DE LA LIBERATION 77340 PONTAULT COMBAULT  
France

**Manufacturer**                    :        **ShenZhen Weihejia Electronics Technology CO., LTD**

Address                                :        Room 102, No. 9, Xihu Industrial Zone, Xikeng Community.  
Yuanshan Street, Longgang District, Shenzhen

<b>Test Result</b>	<b>Pass</b>
--------------------	-------------

The above equipment has been tested by Shenzhen Global Test Service Co., Ltd., and found compliance with the requirements set forth in the EMC Directive 2014/30/EU technical standards mentioned above. The results of testing in this report apply only to the product/system, which was tested. Other similar equipment will not necessarily produce the same results due to production tolerance and measurement uncertainties.

## Contents

<b>1. TEST SUMMARY .....</b>	<b>5</b>
<b>2. EUT INFORMATION .....</b>	<b>6</b>
2.1. I/O Port Description .....	6
2.2. EUT operation mode .....	6
2.3. EUT configuration.....	7
<b>3. TEST ENVIRONMENT .....</b>	<b>8</b>
3.1. Address of the test laboratory .....	8
3.2. Test Facility .....	8
3.3. Test Software .....	8
3.4. Statement of the measurement uncertainty .....	9
3.5. Test Site Environmental .....	10
3.6. Test Instruments.....	11
<b>4. TEST CONDITIONS AND RESULTS .....</b>	<b>14</b>
4.1. Conducted Emission .....	14
4.1.1 Limits .....	14
4.1.2 Test Configuration .....	14
4.1.3 Test Procedure.....	15
4.1.4 Test Results .....	16
4.2. CONDUCTED EMISSION (WIRED NETWORK PORT).....	18
4.3. Radiated Emission .....	19
4.2.1 Limit.....	19
4.2.2 Test Configuration.....	20
4.2.3 Test Procedure.....	22
4.2.4 Test Results .....	23
4.4. Harmonic Current .....	26
4.3.1 Limit.....	26
4.3.2 Test Configuration.....	27
4.3.3 Test Procedure.....	27
4.3.4 Test Results .....	27
4.5. Voltage Fluctuation and Flicker .....	28
4.4.1 Limit.....	28
4.4.2 Test Configuration.....	28
4.4.3 Test Procedure.....	29
4.4.4 Test Results .....	29
4.6. Electrostatic Discharge (ESD).....	30
4.5.1 Test Specification .....	30
4.5.2 Test Configuration.....	30
4.5.3 Test Procedure.....	30
4.5.4 Test Results .....	31
4.7. Radiated Electromagnetic Field (RS).....	32
4.6.1 Test Specification .....	32
4.6.2 Test Configuration.....	32
4.6.3 Test Procedure.....	32
4.6.4 Test Results .....	33
4.8. Electrical Fast Transient/Burst (EFT) .....	34
4.7.1 Test Specification .....	34
4.7.2 Test Configuration.....	34
4.7.3 Test Procedure.....	34
4.7.4 Test Results .....	35

- 4.9. Surge .....36
  - 4.8.1 Test Specification .....36
  - 4.8.2 Test Configuration .....36
  - 4.8.3 Test Procedure .....36
  - 4.8.4 Test Results .....37
- 4.10. Conducted Susceptibility (CS) .....38
  - 4.9.1 Test Specification .....38
  - 4.9.2 Test Configuration .....38
  - 4.9.3 Test Procedure .....39
  - 4.9.4 Test Results .....39
- 4.11. Power Frequency Magnetic Field (PMF) .....40
  - 4.10.1 Test Specification .....40
  - 4.10.2 Test Configuration .....40
  - 4.10.3 Test Procedure .....40
  - 4.10.4 Test Results .....41
- 4.12. Voltage Dips and Interruptions .....42
  - 4.11.1 Test Specification .....42
  - 4.11.2 Test Configuration .....42
  - 4.11.3 Test Procedure .....42
  - 4.11.4 Test Results .....43
- 5. TEST SETUP PHOTOS OF THE EUT .....44**
- 6. PHOTOS OF THE EUT .....48**

**1. TEST SUMMARY**

Emission			
Standard	Item	Verdict	Remark
EN 55032:2015/A11:2020	Conducted Emission	PASS	Meet Class B limit
	Radiated Emission	PASS	Meet Class B limit
EN IEC 61000-3-2:2019/A1:2021	Harmonic Current Emissions	N/A	N/A
EN 61000-3-3:2013/A2:2021/AC:2022-01	Voltage Fluctuations & Flicker	PASS	Meets the requirements

Immunity			
Standard	Item	Result	Remark
EN 55035:2017/A11:2020 EN 61000-4-2: 2009	ESD	PASS	Meets the requirements of Criterion B
EN 55035:2017/A11:2020 EN IEC 61000-4-3:2020	RS	PASS	Meets the requirements of Criterion A
EN 55035:2017/A11:2020 EN 61000-4-4: 2012	EFT	PASS	Meets the requirements of Criterion B
EN 55035:2017/A11:2020 EN 61000-4-5:2014/A1:2017	Surge	PASS	Meets the requirements of Criterion B
EN 55035:2017/A11:2020 EN 61000-4-6:2014/AC:2015	CS	PASS	Meets the requirements of Criterion A
EN 55035:2017/A11:2020 EN 61000-4-8:2010	PMF	PASS	Meets the requirements of Criterion A
EN 55035:2017/A11:2020 EN IEC 61000-4-11:2020	Voltage Dips & Voltage Variations	PASS	Meets the requirements of Voltage Dips: 1) >95% reduction Criterion B 2) 30% reduction Criterion C Voltage Interruptions: >95% reduction Criterion C

The test results of this report was related only to the tested sample(s) identified in this report. Manufacturer or whom it may concern should recognize the pass or fail of the test result.

## 2. EUT INFORMATION

### 2.1. I/O Port Description

I/O Port Types	Q'TY	Test Description
1). DC IN Port	1	Connect to Adapter
2). Earphone Port	1	Connect to Earphone

### 2.2. EUT operation mode

Pre-Test Mode	Mode 1: Working Mode Mode 2: Idle Mode		
Final Test Mode	Conducted Emission		Mode 1
	Radiates Emission	Below 1GHz	Mode 1
		Above 1GHz	Mode 1
	Harmonic Current Emissions		N/A
	Voltage Fluctuations & Flicker		Mode 1
	ESD		Mode 1
	RS		Mode 1
	EFT		Mode 1
	Surge		Mode 1
	CS		Mode 1
	PMF		Mode 1
Voltage Dips & Voltage Variations		Mode 1	

Then, the above highest emission mode of the configuration of the EUT and cable was chosen for all final test items.

\*\*\*Note:

Pre-test at both voltage AC 120V/60Hz and AC 230V/50Hz, but we only recorded the worst case in this report.

### 2.3.EUT configuration

The following peripheral devices and interface cables were connected during the measurement:

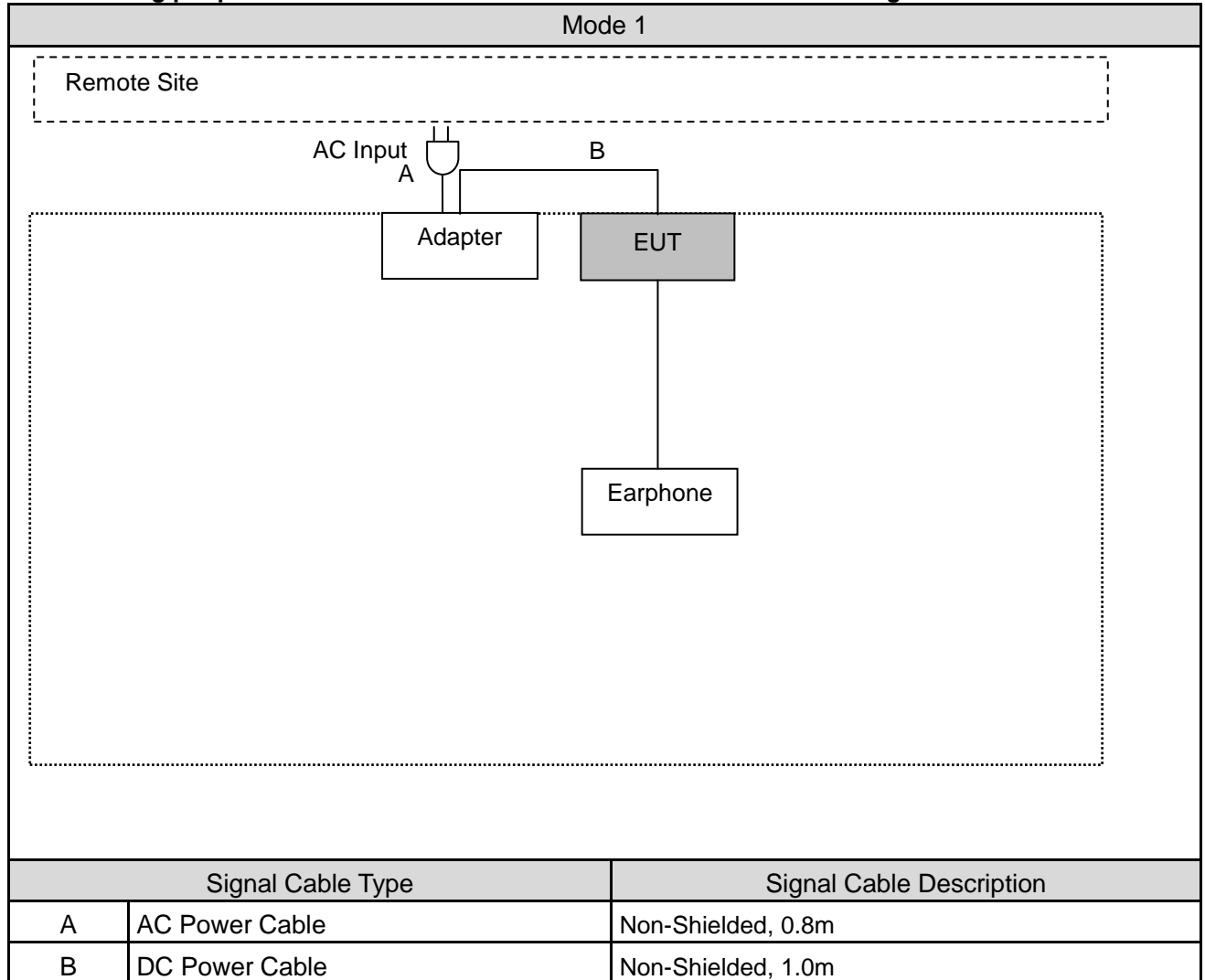

Devices Description					
Product		Manufacturer	Model Number	Serial Number	Power Cord
(1)	Adapter	SHENZHEN BAOCHANGTONG TECHNOLOGY CO.,LTD	BCT050200-078OU	N/A	Non-Shielded, 1.0m
(2)	Earphone	SONY	MDR-XB550AP	N/A	Non-Shielded, 1.0m

### 3. TEST ENVIRONMENT

#### 3.1. Address of the test laboratory

##### Shenzhen Global Test Service Co., Ltd.

No.7-101 and 8A-104, Building 7 and 8, DCC Cultural and Creative Garden, No.98, Pingxin North Road, Shangmugu Community, Pinghu Street, Longgang District, Shenzhen, Guangdong

#### 3.2. Test Facility

The test facility is recognized, certified, or accredited by the following organizations:

CNAS (No. CNAS L8169)

Shenzhen Global Test Service Co., Ltd. has been assessed and proved to be in compliance with CNAS-CL01 Accreditation Criteria for Testing and Calibration Laboratories (identical to ISO/IEC 17025: 2019 General Requirements) for the Competence of Testing and Calibration Laboratories.

A2LA (Certificate No. 4758.01)

Shenzhen Global Test Service Co., Ltd. has been assessed by the American Association for Laboratory Accreditation (A2LA). Certificate No. 4758.01.

Industry Canada Registration Number. is 24189.

FCC Designation Number is CN1234.

FCC Registered Test Site Number is165725.

#### 3.3. Test Software

Measurement Software			
No.	Description	Software	Version
1	Conducted Emission	JS32-CE	Ver2.5
2	Radiated Emission _ Below 1GHz	JS32-RE	Ver2.5.1.8
3	Radiated Emission _ Above 1GHz	JS32-RE	Ver2.5.1.8
4	Harmonic Current Emissions	Harcs	4.21.0.0
5	Voltage Fluctuations & Flicker	Harcs	4.21.0.0
6	RS	EMC-RS	2.0.1.2
7	CS	IEC/EN 61000-4-6	V1.1.2



**3.4. Statement of the measurement uncertainty**

Test Item	Test Site	Frequency Range	Uncertainty (dB)	
Conducted Emission AC Power Port	Conductive Shielding Room	9 kHz ~ 150 kHz	2.7	
		150 kHz ~ 30 MHz	2.7	
Conducted Emission Telecommunication Port		150 kHz ~ 30 MHz	3.6	
Radiated Emission	966	30 MHz ~ 1000 MHz	Horizontal	5.6
			Vertical	6.0
		1000 MHz ~ 6000 MHz	5.2	

Note: The Vertical and Horizontal measurement uncertainty of 1GHz to 6GHz is evaluated and choose which polarity is worst value.

Test Item	Uncertainty	
Harmonic Current Emission	36 mA/A	
Voltage Fluctuations And Flicker	4.4 mV/V	
Electrostatic Discharge	Voltage	0.86 %
	Current	2.5 %
	Timing	6.0 %
Radiated Susceptibility	3.2 dB	
Electrical Fast Transient/Burst	2 %	
Surge	Voltage	3 %
	Current	3 %
	Timing	3 %
Conducted Susceptibility	CDN	3.8 dB
	EM Clamp/Direct Injection	2.8 dB
Power Frequency Magnetic Field	36 mA/A	
Voltage Dips and Interruption	Voltage	1.004 %
	Timing	1.004 %

**3.5. Test Site Environmental**

Test Item	Required (IEC 60068-1)		Actual
Conducted Emission	Temperature (°C)	15-35	26
	Humidity (%RH)	25-75	60
	Barometric pressure (mbar)	860-1060	950
Radiated Emission	Temperature (°C)	15-35	26
	Humidity (%RH)	25-75	60
	Barometric pressure (mbar)	860-1060	950
Harmonic Current Emissions	Temperature (°C)	--	26.0
	Humidity (%RH)	--	60.0
	Barometric pressure (mbar)	--	950
Voltage Fluctuations & Flicker	Temperature (°C)	--	26.0
	Humidity (%RH)	--	60.0
	Barometric pressure (mbar)	--	950
ESD	Temperature (°C)	15-35	26.0
	Humidity (%RH)	30-60	60.0
	Barometric pressure (mbar)	860-1060	950
RS	Temperature (°C)	--	26.0
	Humidity (%RH)	--	60.0
	Barometric pressure (mbar)	--	950
EFT	Temperature (°C)	15-35	26.0
	Humidity (%RH)	30-60	60.0
	Barometric pressure (mbar)	860-1060	950
Surge	Temperature (°C)	15-35	26.0
	Humidity (%RH)	10-75	60.0
	Barometric pressure (mbar)	860-1060	950
CS	Temperature (°C)	--	26.0
	Humidity (%RH)	--	60.0
	Barometric pressure (mbar)	--	950
PMF	Temperature (°C)	15-35	26.0
	Humidity (%RH)	25-75	60.0
	Barometric pressure (mbar)	860-1060	950
Voltage Dips & Voltage Variations	Temperature (°C)	15-35	26.0
	Humidity (%RH)	25-75	60.0
	Barometric pressure (mbar)	860-1060	950

### 3.6. Test Instruments

Test Period: May. 07, 2023

Conducted Emission test site					
Equipment	Manufacturer	Model Number	Serial Number	Cal. Date	Cal. Period
Test Receiver	R&S	ESPI 3	101841	2022/07/13	1 year
Transient Limiter	CYBERTEK	EM5010A	E1950100106	2022/07/13	1 year
LISN	R&S	ESH2-Z5	893606/008	2022/07/13	1 year
LISN	CYBERTEK	EM5040A	E1850400105	2022/07/13	1 year
ISN	SCHWARZBECK	CAT 3	066	2022/09/09	1 year
ISN	SCHWARZBECK	CAT 5	121	2022/09/09	1 year
ISN	SCHWARZBECK	NTFM	102	2022/09/09	1 year
Test Site	XINJU	Conductive Shielding Room	N/A	N.C.R.	-----

Test Period: May. 07, 2023

966 Chamber					
Equipment	Manufacturer	Model Number	Serial Number	Cal. Date	Cal. Period
Amplifier	SCHWARZBECK MESS- ELEKTRONIK	BBV 9743	202	2022/07/13	1 year
Amplifier	EMCI	EMC051845SE	980355	2022/07/13	1 year
Test Receiver	R&S	ESCI 7	101102	2022/07/13	1 year
Spectrum Analyzer	R&S	FSV40-N	101800	2022/07/13	1 year
Broadband Antenna	SCHWARZBECK MESS- ELEKTRONIK	VULB 9163	00976	2022/07/13	1 year
Double Ridged Horn Antenna (1~18GHz)	SCHWARZBECK MESS-ELEKTRONIK	BBHA 9120D	01622	2022/09/09	1 year
Horn Antenna (18GHz~40GHz)	ETS	3116C	00086467	2022/09/09	1 year
Test Site	XINJU	966	N/A	2021/09/19	3 year

Test Period: May. 07, 2023

Harmonics Current / Voltage Fluctuation and Flicker test site					
Equipment	Manufacturer	Model Number	Serial Number	Cal. Date	Cal. Period
EMC Immunity Tester	EMC-PARTNER AG	HARMONICS 1000	HAR1000-1P 230V-0221	2022/07/13	1 year
Test Site	XINJU	RF Shielding Room	N/A	N.C.R.	-----

Test Period: May. 08, 2023

Electrostatic Discharge test site					
Equipment	Manufacturer	Model Number	Serial Number	Cal. Date	Cal. Period
ESD Simulator	EMC-PARTNER AG	ESD 3000	ESD3000-1680	2022/09/09	1 year
0.8m Height Wooden Table	N/A	N/A	N/A	N.C.R.	-----
Test Site	EMS Lab	N/A	N/A	N.C.R.	-----

Test Period: May. 08, 2023

Radiated Electromagnetic Field test site					
Equipment	Manufacturer	Model Number	Serial Number	Cal. Date	Cal. Period
SMB 100A SIGNAL GENERATOR	R&S	SMB100A	100724	2022/07/13	1 year
NRP-Z91 POWER SENSOR	R&S	NRP-Z91	100611	2022/07/13	1 year
NRP-Z91 POWER SENSOR	R&S	NRP-Z91	100613	2022/07/13	1 year
NRP POWER METER	R&S	NRP	101591	2022/07/13	1 year
Solid State Power Amplifier	R&K	GA020M102-5454F	830140	N.C.R.	-----
Direction Coupler	WERLATONE	C8686-714	109646	N.C.R.	-----
Signal Generator Module	R&S	SM300 Module	102209	N.C.R.	-----
RS Amplifier	MILMEGA	AS0860B-50/50	1078855	N.C.R.	-----
Broad-Band Horn Antenna	SCHWARZBECK MESS-ELEKTRONIK	BBHA 9120	BBHA 9120 E388	N.C.R.	-----
Test Site	XINJU	966	N/A	2021/09/19	3 years

Test Period: May. 08, 2023

Electrical Fast Transient/Burst / Surge / Power Frequency Magnetic Field / Voltage Dips and Interruption test site					
Equipment	Manufacturer	Model Number	Serial Number	Cal. Date	Cal. Period
EMC Immunity Tester	EMC-PARTNER AG	HARMONICS 1000	HAR1000-1P 230V-0221	2022/09/09	1 year
Magnetic Field Antenna	EMC-PARTNER AG	MF1000-1	155	2022/09/09	1 year
EMC Immunity Tester	EMC-PARTNER AG	TRANSIENT 3000	TRA3000 F5-S-D-V-1527	2022/09/09	1 year
Coupling Clamp	EMC-PARTNER AG	CN-EFT1000	CN-EFT1000-1574	2022/09/09	1 year
Signal Line Coupling Network	EMC-PARTNER AG	CN-R40C05	CN-R40C05-1513	2022/09/09	1 year
Magnetic Field Antenna	EMC-PARTNER AG	MF1000-1	155	2022/09/09	1 year
Test Site	EMS Lab	N/A	N/A	N.C.R.	-----

Test Period: May. 08, 2023

Conducted disturbances induced by radio-frequency fields					
Equipment	Manufacturer	Model Number	Serial Number	Cal. Date	Cal. Period
CS Test system	Frankonia	CIT-10-75	126B1333	2022/09/09	1 year
6dB Attenuator	Frankonia	75-A-FFN-06	1509	2022/09/09	1 year
CDN	Frankonia	M2+M3	A2210239	2022/09/09	1 year
Power Clamp	Frankonia	EMCL-20	132A1216	2022/09/09	1 year

The calibration interval was one year.

## 4. TEST CONDITIONS AND RESULTS

### 4.1. Conducted Emission

#### 4.1.1 Limits

##### A.C. Mains Conducted Interference Limit

Frequency (MHz)	Class A (dBuV)		Class B (dBuV)	
	Quasi-peak	Average	Quasi-peak	Average
0.15 - 0.5	79	66	66 - 56	56 - 46
0.50 - 5.0	73	60	56	46
5.0 - 30.0	73	60	60	50

Note: (1) The lower limit shall apply at the transition frequencies.

(2) The limit decreases in line with the logarithm of the frequency in the range 0.15 to 0.50 MHz.

(3) All emanations from a class A/B digital device or system, including any network of conductors and apparatus connected thereto, shall not exceed the level of field strengths specified above.

##### Telecommunication Port Asymmetric mode Conducted Interference Limit

Requirement (MHz)	Class A Equipment				Class B Equipment			
	Voltage Limit (dBuV)		Current Limit (dBuA)		Voltage Limit (dBuV)		Current Limit (dBuA)	
	QP	Avg.	QP	Avg.	QP	Avg.	QP	Avg.
0.15 to 0.50	97 to 87	84 to 74	53 to 43	40 to 30	84 to 74	74 to 64	40 to 30	30 to 20
0.50 to 30	87	74	43	30	74	64	30	20

#### 4.1.2 Test Configuration

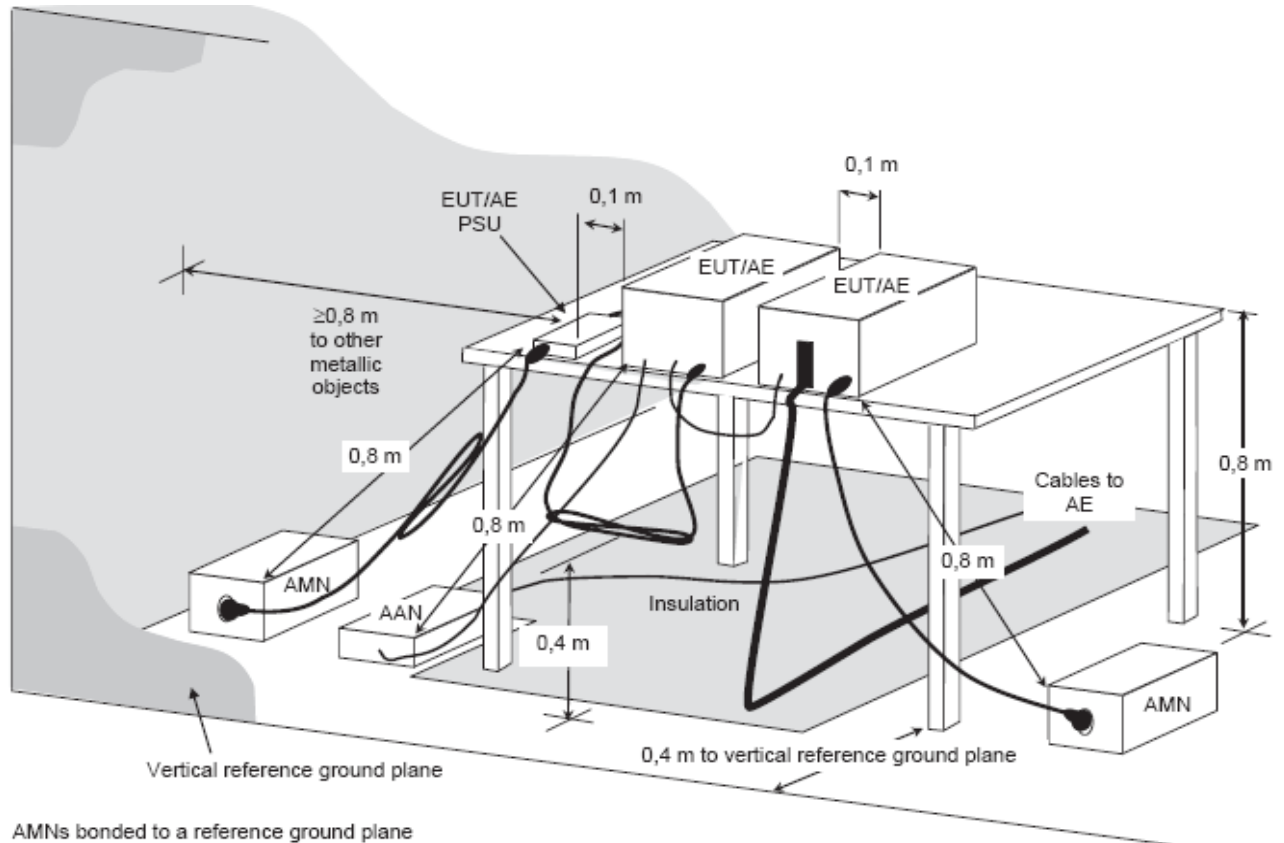

### 4.1.3 Test Procedure

#### A.C. Mains Conducted Interference

##### Procedure of Preliminary Test

The EUT and support equipment, if needed, were set up as per the test configuration to simulate typical usage per the user's manual. When the EUT is a tabletop system, a wooden table with a height of 0.8 meters is used and is placed on the ground plane as per EN 55032 (see Test Facility for the dimensions of the ground plane used). When the EUT is a floor-standing equipment, it is placed on the ground plane, which has a less than 15 cm non-conductive covering to insulate the EUT from the ground plane.

All I/O cables were positioned to simulate typical actual usage as per EN 55032.

The EUT installed by AC main power, through a Line Impedance Stabilization Network (LISN), which was supplied power source and was grounded to the ground plane.

All support equipment power by a second LISN.

The test program of the EUT was started. Emissions were measured on each current carrying line of the EUT using an EMI Test Receiver connected to the LISN powering the EUT.

The Receiver scanned from 150 kHz to 30 MHz for emissions in each of the test modes.

During the above scans, the emissions were maximized by cable manipulation.

The test mode(s) described in Item 3.1 were scanned during the preliminary test.

After the preliminary scan, we found the test mode described in Item 3.1 producing the highest emission level.

The worst configuration of EUT and cable of the above highest emission level were recorded for reference of the final test.

##### Procedure of Final Test

EUT and support equipment were set up on the test bench as per the configuration with highest emission level in the preliminary test.

A scan was taken on both power lines, Line 1 and Line 2, recording at least the six highest emissions. Emission frequency and amplitude were recorded into a computer in which correction factors were used to calculate the emission level and compare reading to the applicable limit.

The test data of the worst-case condition(s) was recorded.

Cables connecting to AE located outside the measurement area shall drop directly to, but be insulated from, the RGP shall be used thickness of the insulation and shall not be more than 150 mm. However, cables which would normally be bonded to ground should be bonded to the RGP in accordance with normal practice or the manufacturer's recommendation

#### Telecommunication Port Conducted Interference

Selecting ISN for unscreened cable and screened cable to make measurement and Current probe for coaxial cable.

The port of the EUT was connected to the remote side support equipment through the ISN/Current Probe and communication in normal condition.

Making a overall range scan by using the test receiver controlled by controller and record at least six highest emissions for showing in the test report.

Emission frequency and amplitude were recorded into a computer in which correction factors were used to calculate the emission level and compare reading to the applicable limit.

In case of measuring on the screened cable, the current limit shall be applied; otherwise the voltage limit should be applied.

### 4.1.4 Test Results

Test Standard:	EN 55032	Power Line:	L1
Test Mode:	Mode 1	Test Power:	AC 230 V/50 Hz
Description:			

#### Test Graph

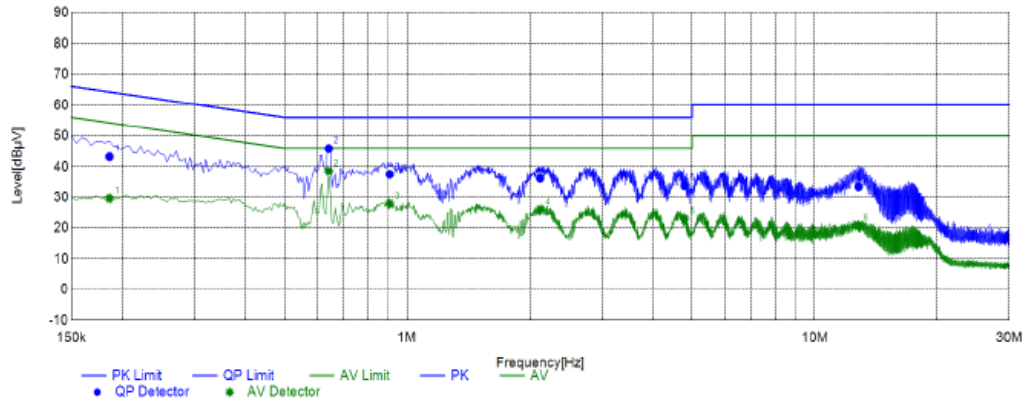

#### Final Data List

NO.	Frequency	QP Reading	AVG. Reading	Factor	QP Result	AVG. Result	QP Limit	AVG. Limit	QP Margin	AVG. Margin	Line	Remark
1	0.1863	33.61	20.06	9.58	43.19	29.64	64.20	54.20	21.01	24.56	L1	PASS
2	0.6421	36.28	28.90	9.57	45.85	38.47	56.00	46.00	10.15	7.53	L1	PASS
3	0.9062	28.12	18.52	9.37	37.49	27.89	56.00	46.00	18.51	18.11	L1	PASS
4	2.1223	26.82	16.67	9.36	36.18	26.03	56.00	46.00	19.82	19.97	L1	PASS
5	4.7950	24.45	13.75	9.37	33.82	23.12	56.00	46.00	22.18	22.88	L1	PASS
6	12.8109	24.31	11.64	9.17	33.48	20.81	60.00	50.00	26.52	29.19	L1	PASS

Note: 1. Result (dBµV) = Reading (dBµV) + Factor (dB).

2. Factor (dB) = Cable loss (dB) + LISN Factor (dB).



Test Standard:	EN 55032	Power Line:	N
Test Mode:	Mode 1	Test Power:	AC 230 V/50 Hz
Description:			

**Test Graph**

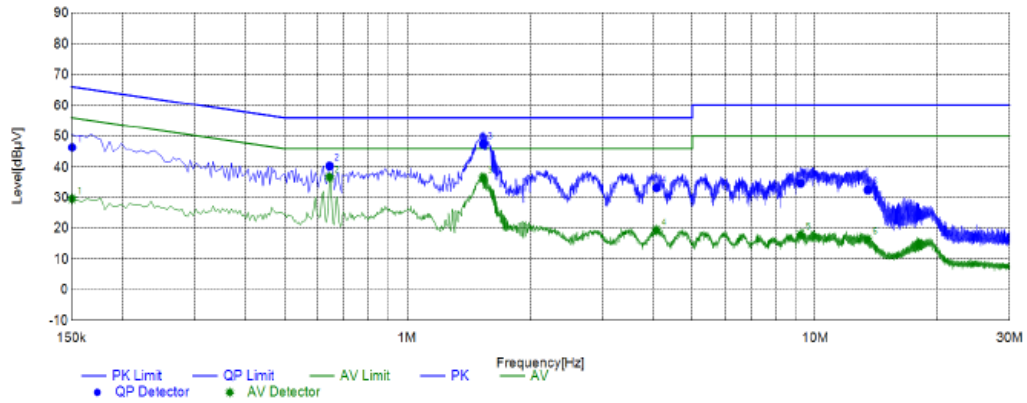

Final Data List												
NO.	Frequency	QP	AVG.	Factor	QP	AVG.	QP	AVG.	QP	AVG.	Line	Remark
		Reading	Reading		Result	Result	Limit	Limit	Margin	Margin		
1	0.1508	36.74	20.02	9.61	46.35	29.63	65.96	55.96	19.61	26.33	N	PASS
2	0.6448	30.93	27.22	9.40	40.33	36.62	56.00	46.00	15.67	9.38	N	PASS
3	1.5339	38.12	26.92	9.36	47.48	36.28	56.00	46.00	8.52	9.72	N	PASS
4	4.0864	23.87	10.02	9.39	33.26	19.41	56.00	46.00	22.74	26.59	N	PASS
5	9.2297	25.38	8.60	9.29	34.67	17.89	60.00	50.00	25.33	32.11	N	PASS
6	13.4466	23.37	7.31	9.19	32.56	16.50	60.00	50.00	27.44	33.50	N	PASS

Note: 1. Result (dBµV) = Reading (dBµV) + Factor (dB).

2. Factor (dB) = Cable loss (dB) + LISN Factor (dB).

**\*\*\*Note:**

Pre-test at both voltage AC 120V/60Hz and AC 230V/50Hz, but we only recorded the worst case in this report.

### 4.2. CONDUCTED EMISSION (WIRED NETWORK PORT)

#### Conducted Emission Limit(Wired Network Port)

Limits for asymmetric mode conducted emissions				
Frequency (MHz)	Class B voltage limits (dB $\mu$ V)		Class B current limits (dB $\mu$ A)	
	Quasi-peak Level	Average Level	Quasi-peak Level	Average Level
0.15 ~ 0.50	84.0~74.0	74.0~64.0	40.0~30.0	30.0~20.0
0.50 ~ 30.00	74.0	64.0	30.0	20.0

NOTE 1-The limits decrease linearly with the logarithm of the frequency in the range 0,15 MHz to 0,5 MHz.

NOTE 2-The current and voltage disturbance limits are derived for use with an impedance stabilization network (ISN) which presents a common mode (asymmetric mode) impedance of 150 $\Omega$  to the telecommunication port under test (conversion factor is  $20 \log_{10} 150 / I = 44 \text{ dB}$ ).

#### Test Configuration

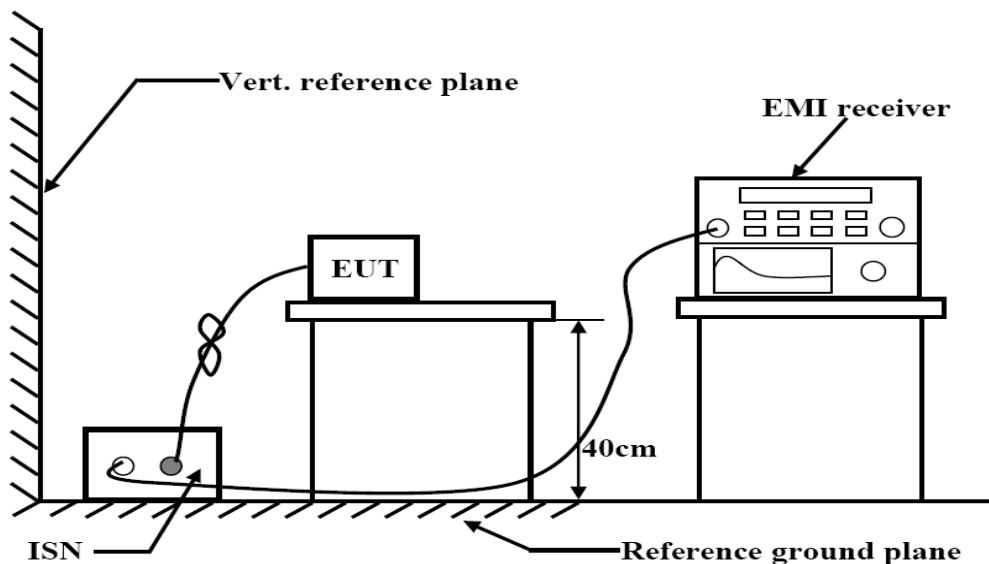

#### EMI Test Receiver Setup

During the conducted emission test, the EMI test receiver was set with the following configurations:

Receiver Parameter	Setting
Attenuation	Auto
Start ~ Stop Frequency	150KHz ~ 30MHz
(IF)RBW	9kHz

All data was recorded in the Quasi-peak and average detection mode.

#### Test Procedure

Not applicable.

### 4.3. Radiated Emission

#### 4.2.1 Limit

Frequency (MHz)	dBuV/m (Distance 3 m)	
	Class A	Class B
30 ~ 230	50	40
230 ~ 1000	57	47

Note: The lower limit shall apply at the transition frequencies.

Frequency (MHz)	dBuV/m (Distance 3 m)			
	Class A		Class B	
	Average	Peak	Average	Peak
1000 ~ 3000	56	76	50	70
3000 ~ 6000	60	80	54	74

Note: The lower limit shall apply at the transition frequencies.

According to EN55032 the measurement frequency range is shown in the following table:

Highest frequency generated or used within the EUT or on which the EUT operates or tunes (MHz)	Upper frequency of measurement range (MHz)
Less than 108	1000
108-500	2000
500-1000	5000
Above 1000	5 times of the highest frequency or 6GHz, whichever is less

### 4.2.2 Test Configuration

■ Below 1GHz

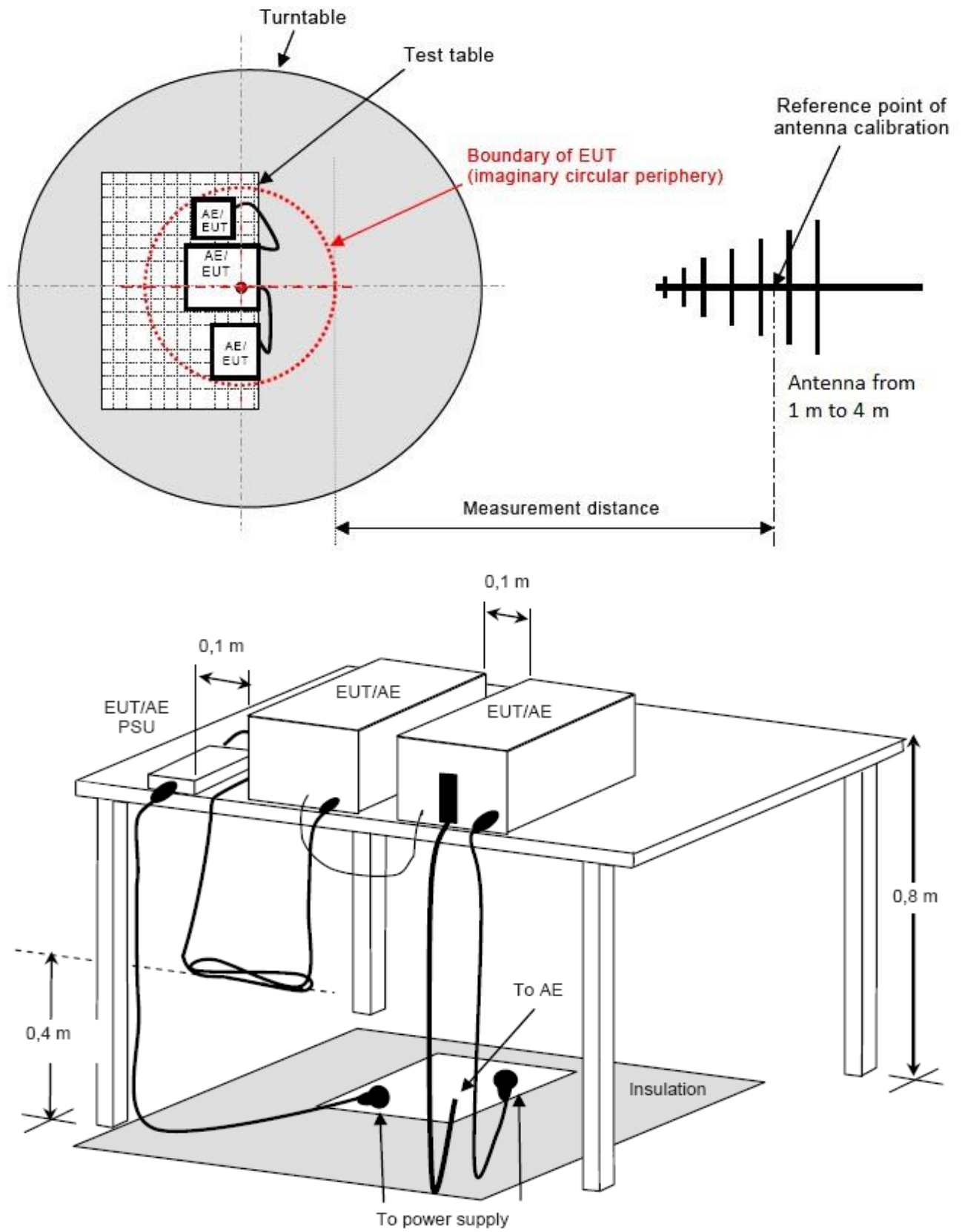

■ Above 1GHz

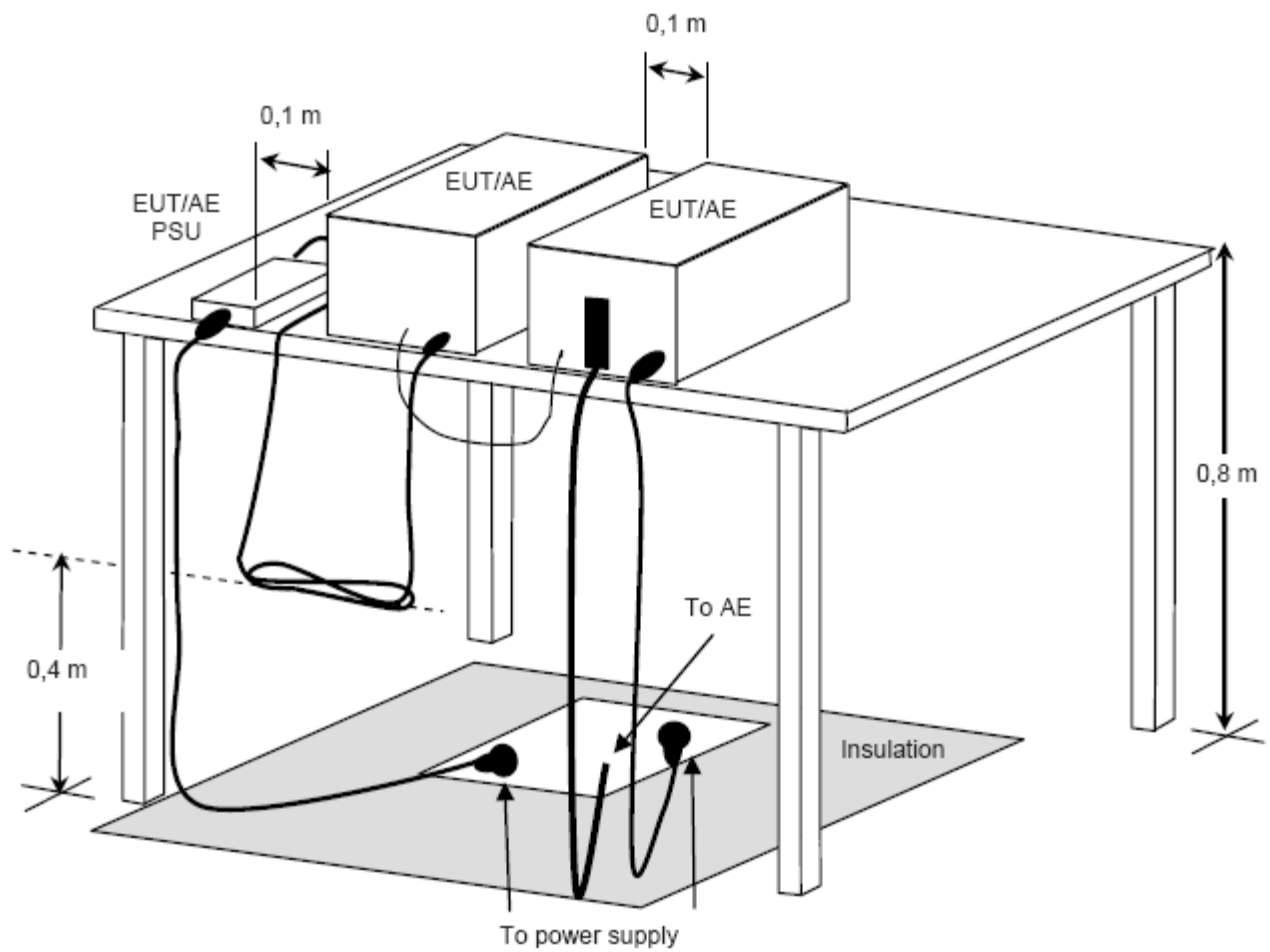
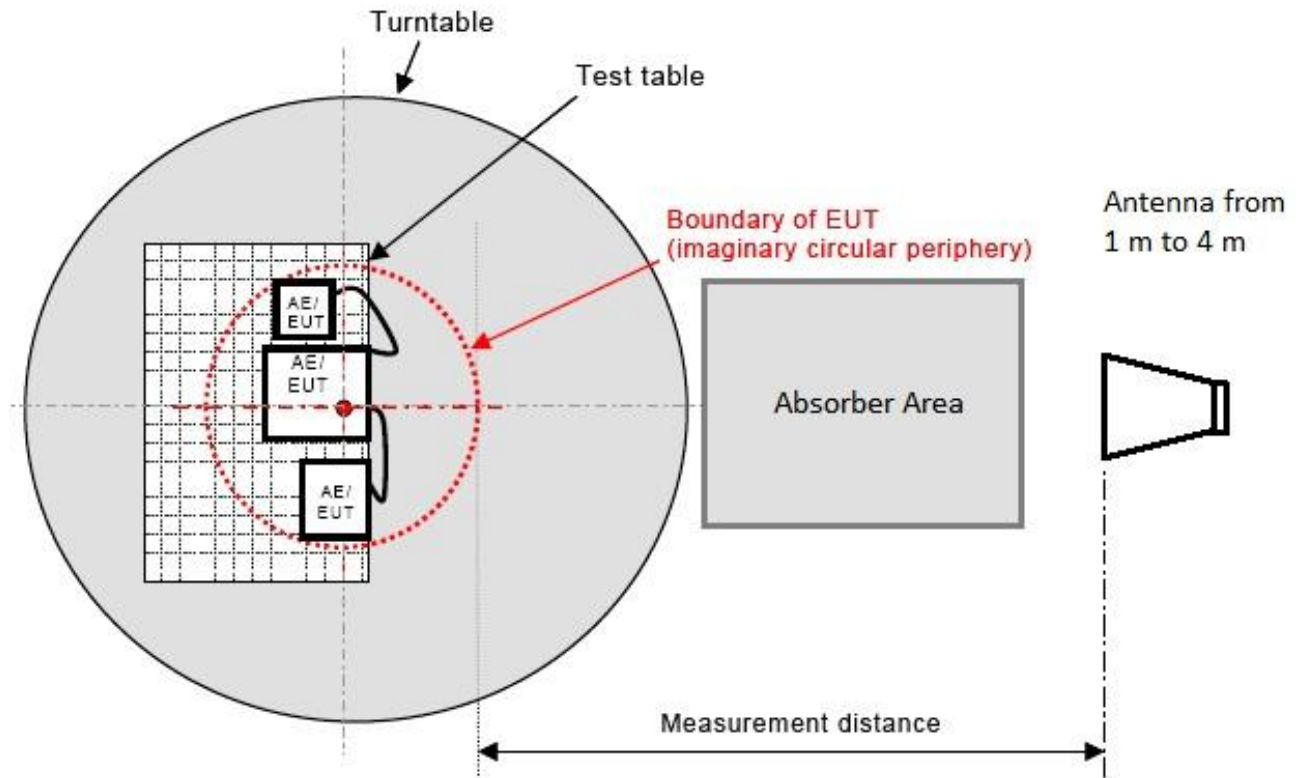

### 4.2.3 Test Procedure

#### ■ Procedure of Preliminary Test.

The equipment was set up as per the test configuration to simulate typical usage per the user's manual. When the EUT is a tabletop system, a wooden turntable with a height of 0.8 meters is used which is placed on the ground plane. When the EUT is a floor standing equipment, it is placed on the ground plane which has a less than 150 mm non-conductive covering to insulate the EUT from the ground plane.

Support equipment, if needed, was placed as per EN 55032.

All I/O cables were positioned to simulate typical usage as per EN 55032.

The EUT received AC power source from the outlet socket under the turntable. All support equipment power received from another socket under the turntable.

The antenna was placed at 3 or 10 meter away from the EUT as stated in EN 55032 Annex C.2.2.4 Figure C.1 and Annex D Table D.1. The antenna connected to the Spectrum Analyzer via a cable and at times a pre-amplifier would be used.

The Analyzer / Receiver quickly scanned from 30MHz to 6GHz. The EUT test program was started. Emissions were scanned and measured rotating the EUT to 360 degrees and positioning the antenna 1 to 4 meters above the ground plane, in both the vertical and the horizontal polarization, to maximize the emission reading level (For Below 1GHz) and keeping the antenna in the 'cone of radiation' from that area and pointed at the area both in azimuth and elevation, with polarization oriented for maximum response (For Above 1GHz).

The test mode(s) described in Item 3.1 were scanned during the preliminary test:

After the preliminary scan, we found the test mode described in Item 3.1 producing the highest emission level. The worst configuration of EUT and cable, antenna position, polarization and turntable position of the above highest emission levels were recorded for the final test.

#### ■ Procedure of Final Test

EUT and support equipment were set up on the turntable as per the configuration with highest emission level in the preliminary test.

The Analyzer / Receiver scanned from 30MHz to 6000MHz. Emissions were scanned and measured rotating the EUT to 360 degrees, varying cable placement and positioning the antenna 1 to 4 meters above the ground plane, in both the vertical and the horizontal polarization, to maximize the emission reading level.

Recording at least the six highest emissions. Emission frequency, amplitude, antenna position, polarization and turntable position were recorded into a computer in which correction factors were used to calculate the emission level and compare reading to the applicable limit and Q.P. (For Below 1GHz) or Peak/Average (For Above 1GHz) reading is presented.

Cables connecting to AE located outside the measurement area shall drop directly to, but be insulated from, the RGP (or turntable where applicable), and then be routed directly to the place where they leave the test site. The thickness of the insulation shall not be more than 150 mm. However, cables which would normally be bonded to ground should be bonded to the RGP in accordance with normal practice or the manufacturer's recommendation

The test data of the worst-case condition(s) was recorded.

### 4.2.4 Test Results

Test Standard:	EN 55032	Test Distance:	3 m
Test Mode:	Mode 1	Test Power:	AC 230 V/50 Hz
Measurement Range:	30 MHz~1 GHz	Ant.Polar.:	Horizontal

#### Test Graph

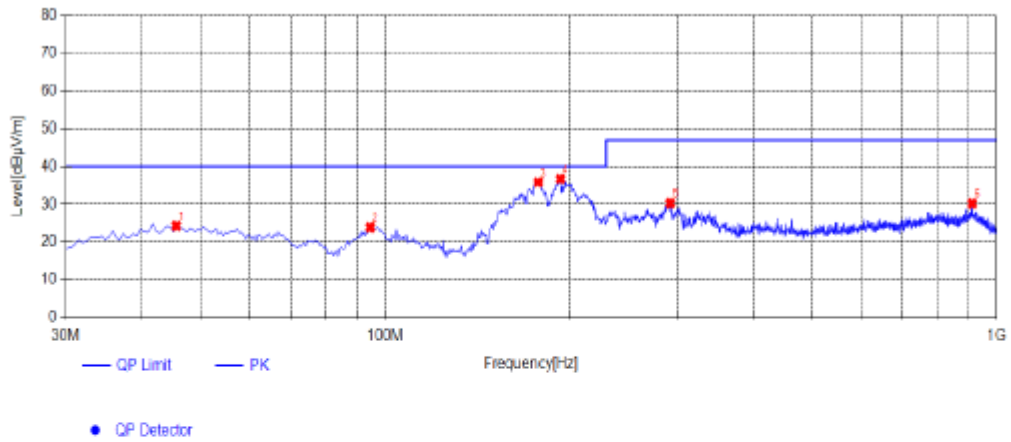

Suspected List											
NO.	Frequency [MHz]	Reading [dBµV/m]	Factor [dB]	Result [dBµV/m]	Limit [dBµV/m]	Margin [dB]	Height [cm]	Angle [°]	Detector	Polarity	Remark
1	45.52	40.00	-15.77	24.23	40.00	15.77	100	250	PK	Horizontal	PASS
2	94.505	42.29	-18.45	23.84	40.00	16.16	100	338	PK	Horizontal	PASS
3	177.925	56.26	-20.43	35.83	40.00	4.17	100	318	PK	Horizontal	PASS
4	193.445	55.75	-19.01	36.74	40.00	3.26	100	325	PK	Horizontal	PASS
5	292.87	47.24	-16.94	30.30	47.00	16.70	100	113	PK	Horizontal	PASS
6	913.185	37.72	-7.49	30.23	47.00	16.77	100	139	PK	Horizontal	PASS

Note:1. Result (dBµV/m) = Reading(dBµV/m) + Factor (dB) .

2. Factor (dB) = Antenna Factor (dB/m) + Cable loss (dB) - Pre Amplifier gain (dB).

Test Standard:	EN 55032	Test Distance:	3 m
Test Mode:	Mode 1	Test Power:	AC 230 V/50 Hz
Measurement Range:	30 MHz~1 GHz	Ant.Polar.:	Vertical

**Test Graph**

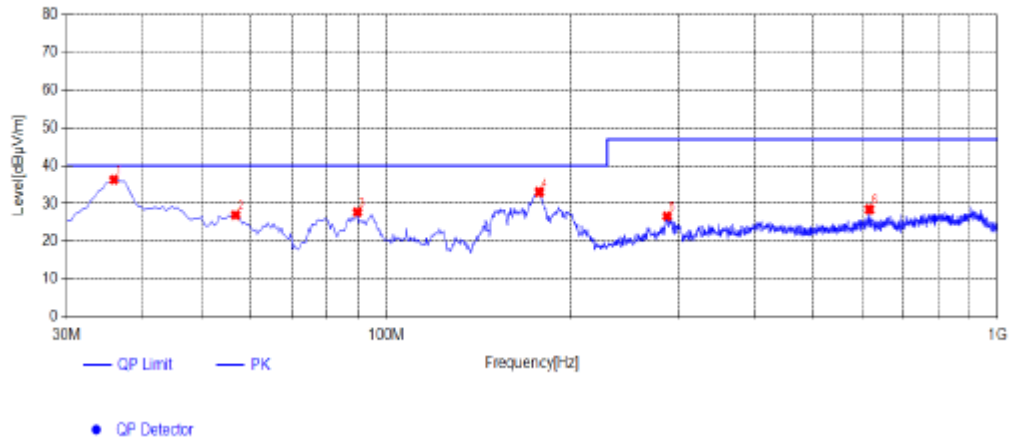

Suspected List											
NO.	Frequency [MHz]	Reading [dBµV/m]	Factor [dB]	Result [dBµV/m]	Limit [dBµV/m]	Margin [dB]	Height [cm]	Angle [°]	Detector	Polarity	Remark
1	35.82	55.00	-18.70	36.30	40.00	3.70	100	65	PK	Vertical	PASS
2	56.675	43.09	-16.15	26.94	40.00	13.06	100	140	PK	Vertical	PASS
3	89.655	47.14	-19.41	27.73	40.00	12.27	100	290	PK	Vertical	PASS
4	177.925	53.42	-20.43	32.99	40.00	7.01	100	352	PK	Vertical	PASS
5	288.02	43.64	-16.98	26.66	47.00	20.34	100	270	PK	Vertical	PASS
6	617.82	39.78	-11.29	28.49	47.00	18.51	100	205	PK	Vertical	PASS

Note:1. Result (dBµV/m) = Reading(dBµV/m) + Factor (dB) .

2. Factor (dB) = Antenna Factor (dB/m) + Cable loss (dB) - Pre Amplifier gain (dB).



Test Mode: TM1(above 1GHz)	Test Distance: 3m
Test voltage: AC 230V/50Hz	Test Results: Passed
Detector Function: Peak+AV	

Frequency MHz	Emission Level dBµV/m		Limits dBµV/m		Margin dBµV/m		Polarization
	Peak	AV	Peak	AV	Peak	AV	
1285.20	54.65	37.94	70.00	50.00	-15.35	-12.06	H
1833.49	57.04	32.78	70.00	50.00	-12.96	-17.22	H
2157.97	53.72	36.75	70.00	50.00	-16.28	-13.25	H
3251.53	53.98	40.07	74.00	54.00	-20.02	-13.93	H
4479.27	52.39	34.43	74.00	54.00	-21.61	-19.57	H
5700.33	52.78	33.69	74.00	54.00	-21.22	-20.31	H
1285.83	54.72	38.02	70.00	50.00	-15.28	-11.98	V
1829.70	57.51	32.19	70.00	50.00	-12.49	-17.81	V
2158.79	53.27	37.11	70.00	50.00	-16.73	-12.89	V
3253.59	53.06	40.61	74.00	54.00	-20.94	-13.39	V
4476.09	53.28	34.85	74.00	54.00	-20.72	-19.15	V
5703.79	52.96	33.52	74.00	54.00	-21.04	-20.48	V

**\*\*\*Note:**

Pre-test at both voltage AC 120V/60Hz and AC 230V/50Hz, but we only recorded the worst case in this report.

### 4.4. Harmonic Current

#### 4.3.1 Limit

Class A Harmonics Currents

Harmonics Order n	Maximum Permissible harmonic current (A)	Harmonics Order n	Maximum Permissible harmonic current (A)
Odd harmonics		Even harmonics	
3	2.30	2	1.08
5	1.14	4	0.43
7	0.77	6	0.30
9	0.40	$8 \leq n \leq 40$	$0.23 \cdot 8/n$
11	0.33		
13	0.21		
$15 \leq n \leq 39$	$0.15 \cdot 15/n$		

Class B Harmonics Currents

**For Class B equipment, the harmonic of the input current shall not exceed the maximum permissible values given in table which is the limit of Class A multiplied by a factor of 1.5.**

Class C Harmonics Currents

Harmonics Order n	Maximum Permissible harmonic current Expressed as a percentage of the input current at the fundamental frequency (%)
2	2
3	$30 \cdot \lambda^*$
5	10
7	7
9	5
$11 \leq n \leq 39$ (odd harmonics only)	3

\*λ is the circuit power factor

Class D Harmonics Currents

Harmonics Order n	Maximum Permissible harmonic current per watt (mA/W)	Maximum Permissible harmonic current (A)
3	3.4	2.30
5	1.9	1.14
7	1.0	0.77
9	0.5	0.40
11	0.35	0.33
$11 \leq n \leq 39$ (odd harmonics only)	$3.85/n$	See limit of Class A

### 4.3.2 Test Configuration

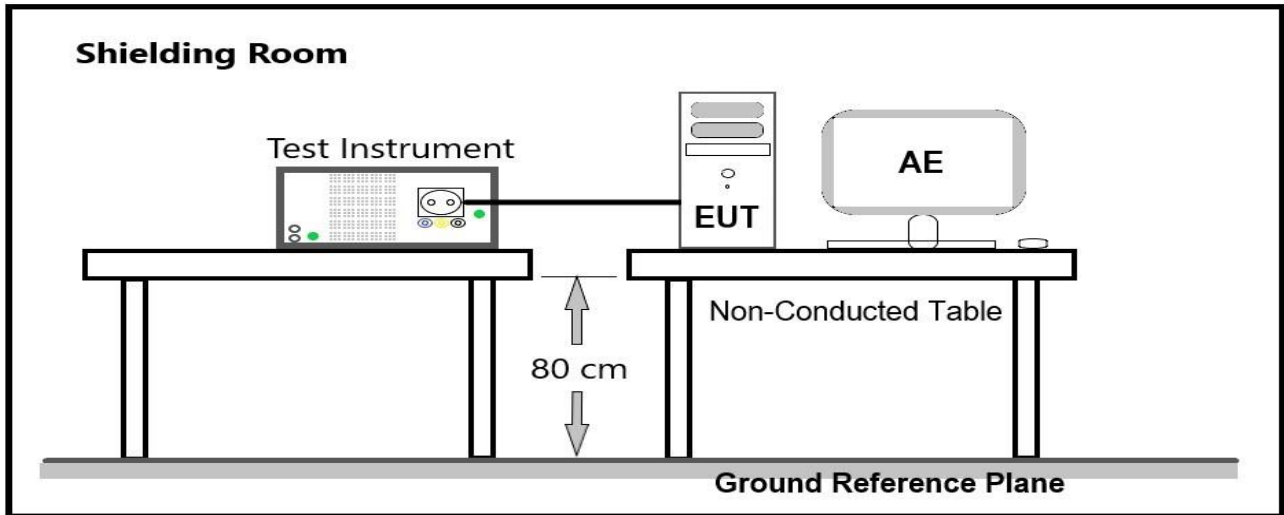

### 4.3.3 Test Procedure

The EUT was placed on the top of a wooden table 0.8 meters above the ground and the EUT is supplied in series with power analyzer from a power source having the same normal voltage and frequency as the rated supply voltage and the equipment under test. And the rated voltage at the supply voltage of EUT of 0.94 times and 1.06 times shall be performed.

A definition of the normal load or of the conditions for adequate heat discharge can usually be found in the EN publication corresponding to the equipment under test.

Equipment may have several separately controlled circuits. Each circuit is considered as a single piece of equipment if it can be operated independently and separately from the other circuits.

### 4.3.4 Test Results

Not applicable to this device (The product without test since the rating power of EUT is less than 75W).

## 4.5. Voltage Fluctuation and Flicker

### 4.4.1 Limit

The following limits apply:

- the value of  $P_{st}$  shall not be greater than 1.0;
- the value of  $P_{1t}$  shall not be greater than 0.65;
- $T_{max}$ , the accumulated time value of  $d(t)$  with a deviation exceeding 3,3 % during a single voltage change at the EUT terminals, shall not exceed 500 ms;
- the relative steady-state voltage change,  $d_c$ , shall not exceed 3.3 %;
- the maximum relative voltage change,  $d_{max}$ , shall not exceed;

a) 4 % without additional conditions;

b) 6 % for equipment which is:

-- switched manually, or

-- switched automatically more frequently than twice per day, and also has either a delayed restart (the delay being not less than a few tens of seconds), or manual restart, after a power supply interruption.

Note: The cycling frequency will be further limited by the  $P_{st}$  and  $P_{1t}$  limit.

For example: a  $d_{max}$  of 6% producing a rectangular voltage change characteristic twice per hour will give a  $P_{1t}$  of about 0.65.

c) 7 % for equipment which is:

-- attended whilst in use (for example: hair dryers, vacuum cleaners, kitchen equipment such as mixers, garden equipment such as lawn mowers, portable tools such as electric drills), or

-- switched on automatically, or is intended to be switched on manually, no more than twice per day, and also has either a delayed restart (the delay being not less than a few tens of seconds) or manual restart, after a power supply interruption.

$P_{st}$  and  $P_{1t}$  requirements shall not be applied to voltage changes caused by manual switching.

### 4.4.2 Test Configuration

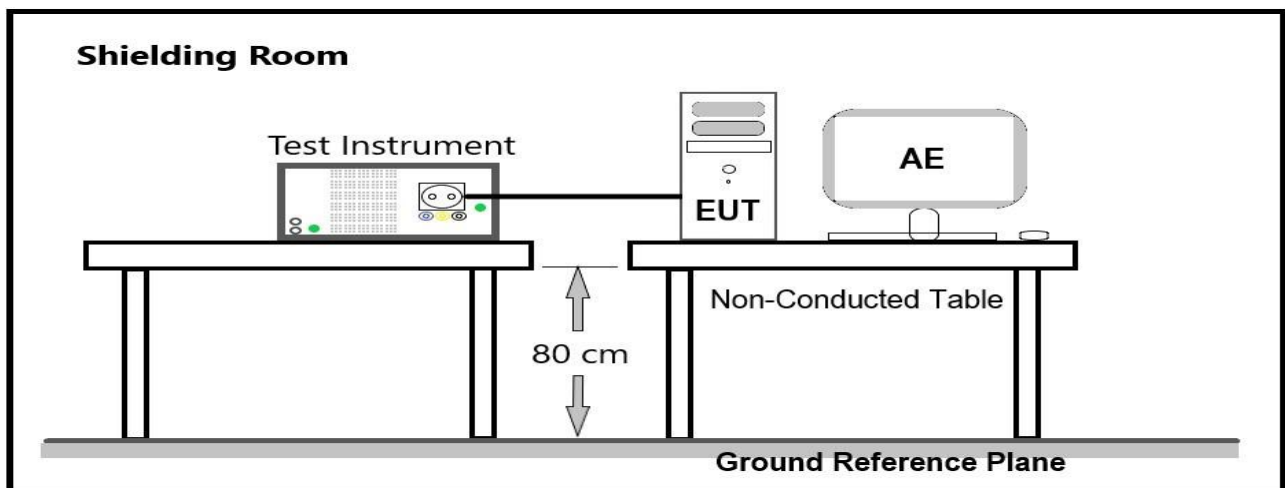

### 4.4.3 Test Procedure

The EUT is supplied in series with power analyzer from a power source having the same normal voltage and frequency as the rated supply voltage and the equipment under test. And the rated voltage at the supply voltage of EUT of 0.94 times and 1.06 times shall be performed.

The EUT was placed on the top of a wooden table 0.8 meters above the ground and operated to produce the most unfavorable sequence of voltage changes under normal operating conditions.

During the flick measurement, the measure time shall include that part of whole operation cycle in which the EUT produce the most unfavorable sequence of voltage changes. The observation period for short-term flicker indicator is 10 minutes and the observation period for long-term flicker indicator is 2 hours.

### 4.4.4 Test Results

#### Maximum Flicker results

	<b>EUT values</b>	<b>Limit</b>	<b>Result</b>
Pst	0.084	1.00	PASS
Plt	0.089	0.65	PASS
dc [%]	0.245	3.30	PASS
dmax [%]	0.625	4.00	PASS
dt [s]	0.077	0.50	PASS

## 4.6. Electrostatic Discharge (ESD)

### 4.5.1 Test Specification

EN 61000-4-2			
Environmental Phenomena	Units	Test Specification	Performance Criterion
Enclosure Port			
Standard requirement Electrostatic Discharge	kV (Charge Voltage)	±8 Air Discharge ±6 Contact Discharge	B

### 4.5.2 Test Configuration

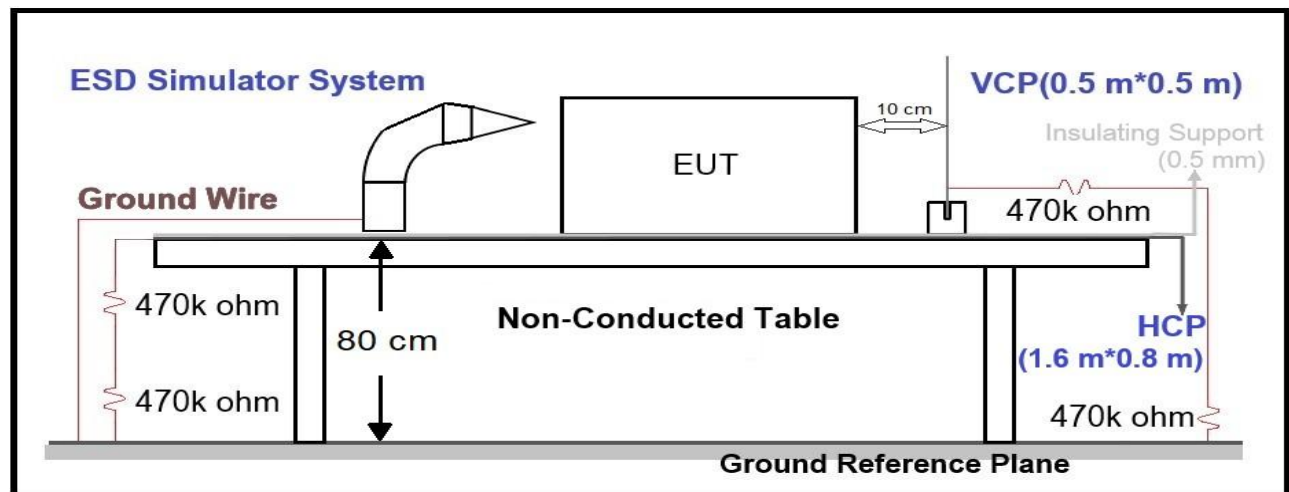

### 4.5.3 Test Procedure

The basic test procedure was in accordance with EN 61000-4-2:

IEC 61000-4-2 specifies that a tabletop EUT shall be placed on a non-conducting table which is 80 centimeters above a ground reference plane and that floor mounted equipment shall be placed on a insulating support approximately 10 centimeters above a ground plane. During the tests, the EUT is positioned over a ground reference plane in conformance with this requirement.

For tabletop equipment, a 1.6 by 0.8-meter metal sheet (HCP) is placed on the table and connected to the ground plane via a metal strap with two 470 k Ohms resistors in series. The EUT and attached cables are isolated from this metal sheet by 0.5-millimeter thick insulating material. A Vertical Coupling Plane (VCP) grounded on the ground plane through the same configuration as in the HCP is used.

#### Air Discharge:

This test is done on a non-conductive surface. The round discharge tip of the discharge electrode shall be approached as fast as possible to touch the EUT. After each discharge, the discharge electrode shall be removed from the EUT. The generator is then re-triggered for a new single discharge and repeated 10 times for each pre-selected test point. This procedure shall be repeated until all the air discharge completed.

#### Contact Discharge:

All the procedure shall be same as Section 8.3.1 of IEC 61000-4-2, except that the tip of the discharge electrode shall touch the EUT before the discharge switch is operated.

#### Indirect discharge for horizontal coupling plane

At least 50 single discharges shall be applied to the horizontal coupling plane, at points on each side of the EUT. The discharge electrode positions vertically at a distance of 0.1 m from the EUT and with the discharge electrode touching the coupling plane.

**Indirect discharge for vertical coupling plane**

At least 50 single discharges shall be applied to the center of one vertical edge of the coupling plane. The coupling plane, of dimensions 0.5m × 0.5m, is placed parallel to, and positioned at a distance of 0.1m from the EUT. Discharges shall be applied to the coupling plane, with this plane in sufficient different positions that the four faces of the EUT are completely illuminated.

**4.5.4 Test Results**

Test Mode:		Mode 1										
Air Discharge												
Test Points	Test Levels						Verdict					
	± 2 kV	Performance Criterion		± 4 kV	Performance Criterion		± 8 kV	Performance Criterion		Pass	Fail	Observation
Earphone	<input checked="" type="checkbox"/>	<input checked="" type="checkbox"/> A	<input type="checkbox"/> B	<input checked="" type="checkbox"/>	<input checked="" type="checkbox"/> A	<input type="checkbox"/> B	<input checked="" type="checkbox"/>	<input checked="" type="checkbox"/> A	<input type="checkbox"/> B	<input checked="" type="checkbox"/>	<input type="checkbox"/>	Note2
DC IN Port	<input checked="" type="checkbox"/>	<input checked="" type="checkbox"/> A	<input type="checkbox"/> B	<input checked="" type="checkbox"/>	<input checked="" type="checkbox"/> A	<input type="checkbox"/> B	<input checked="" type="checkbox"/>	<input checked="" type="checkbox"/> A	<input type="checkbox"/> B	<input checked="" type="checkbox"/>	<input type="checkbox"/>	Note2
Key	<input checked="" type="checkbox"/>	<input checked="" type="checkbox"/> A	<input type="checkbox"/> B	<input checked="" type="checkbox"/>	<input checked="" type="checkbox"/> A	<input type="checkbox"/> B	<input checked="" type="checkbox"/>	<input checked="" type="checkbox"/> A	<input type="checkbox"/> B	<input checked="" type="checkbox"/>	<input type="checkbox"/>	Note1
Shell	<input checked="" type="checkbox"/>	<input checked="" type="checkbox"/> A	<input type="checkbox"/> B	<input checked="" type="checkbox"/>	<input checked="" type="checkbox"/> A	<input type="checkbox"/> B	<input checked="" type="checkbox"/>	<input checked="" type="checkbox"/> A	<input type="checkbox"/> B	<input checked="" type="checkbox"/>	<input type="checkbox"/>	Note1
Earphone	<input checked="" type="checkbox"/>	<input checked="" type="checkbox"/> A	<input type="checkbox"/> B	<input checked="" type="checkbox"/>	<input checked="" type="checkbox"/> A	<input type="checkbox"/> B	<input checked="" type="checkbox"/>	<input checked="" type="checkbox"/> A	<input type="checkbox"/> B	<input checked="" type="checkbox"/>	<input type="checkbox"/>	Note2
Display	<input checked="" type="checkbox"/>	<input checked="" type="checkbox"/> A	<input type="checkbox"/> B	<input checked="" type="checkbox"/>	<input checked="" type="checkbox"/> A	<input type="checkbox"/> B	<input checked="" type="checkbox"/>	<input checked="" type="checkbox"/> A	<input type="checkbox"/> B	<input checked="" type="checkbox"/>	<input type="checkbox"/>	Note2
Discharge To Horizontal Coupling Plane												
Side of EUT	Test Levels				Verdict							
	± 2 kV	± 4 kV	± 6 kV	± 8 kV	Pass	Fail	Performance Criterion		Observation			
Front	<input checked="" type="checkbox"/>	<input checked="" type="checkbox"/>	<input type="checkbox"/>	<input type="checkbox"/>	<input checked="" type="checkbox"/>	<input type="checkbox"/>	<input checked="" type="checkbox"/> A	<input type="checkbox"/> B	Note1			
Back	<input checked="" type="checkbox"/>	<input checked="" type="checkbox"/>	<input type="checkbox"/>	<input type="checkbox"/>	<input checked="" type="checkbox"/>	<input type="checkbox"/>	<input checked="" type="checkbox"/> A	<input type="checkbox"/> B	Note1			
Left	<input checked="" type="checkbox"/>	<input checked="" type="checkbox"/>	<input type="checkbox"/>	<input type="checkbox"/>	<input checked="" type="checkbox"/>	<input type="checkbox"/>	<input checked="" type="checkbox"/> A	<input type="checkbox"/> B	Note1			
Right	<input checked="" type="checkbox"/>	<input checked="" type="checkbox"/>	<input type="checkbox"/>	<input type="checkbox"/>	<input checked="" type="checkbox"/>	<input type="checkbox"/>	<input checked="" type="checkbox"/> A	<input type="checkbox"/> B	Note1			
Discharge To Vertical Coupling Plane												
Side of EUT	Test Levels				Verdict							
	± 2 kV	± 4 kV	± 6 kV	± 8 kV	Pass	Fail	Performance Criterion		Observation			
Front	<input checked="" type="checkbox"/>	<input checked="" type="checkbox"/>	<input type="checkbox"/>	<input type="checkbox"/>	<input checked="" type="checkbox"/>	<input type="checkbox"/>	<input checked="" type="checkbox"/> A	<input type="checkbox"/> B	Note1			
Back	<input checked="" type="checkbox"/>	<input checked="" type="checkbox"/>	<input type="checkbox"/>	<input type="checkbox"/>	<input checked="" type="checkbox"/>	<input type="checkbox"/>	<input checked="" type="checkbox"/> A	<input type="checkbox"/> B	Note1			
Left	<input checked="" type="checkbox"/>	<input checked="" type="checkbox"/>	<input type="checkbox"/>	<input type="checkbox"/>	<input checked="" type="checkbox"/>	<input type="checkbox"/>	<input checked="" type="checkbox"/> A	<input type="checkbox"/> B	Note1			
Right	<input checked="" type="checkbox"/>	<input checked="" type="checkbox"/>	<input type="checkbox"/>	<input type="checkbox"/>	<input checked="" type="checkbox"/>	<input type="checkbox"/>	<input checked="" type="checkbox"/> A	<input type="checkbox"/> B	Note1			

Note1: Criterion A: There was no change compared with initial operation during the test.

Note2: Criterion A: There was no change compared with initial operation during the test.

Criterion B: The output sound and video to Displayer on affected and noise display appears on the screen, can be self recover.

### 4.7. Radiated Electromagnetic Field (RS)

#### 4.6.1 Test Specification

EN 61000-4-3			
Environmental Phenomena	Units	Test Specification	Performance Criterion
Enclosure Port			
Test Frequency Range	MHz	80-1000, 1800, 2600, 3500, 5000	A
RF Electromagnetic Field Amplitude Modulated	V/m (Un-modulated, rms)	3	
	% AM (1kHz)	80	

EUT tested in accordance with the specifications given by the standard of EN 61000-4-3.

Sweeping time of radiated : 0.0015 decade/s

Dwell time : 1 Second

#### 4.6.2 Test Configuration

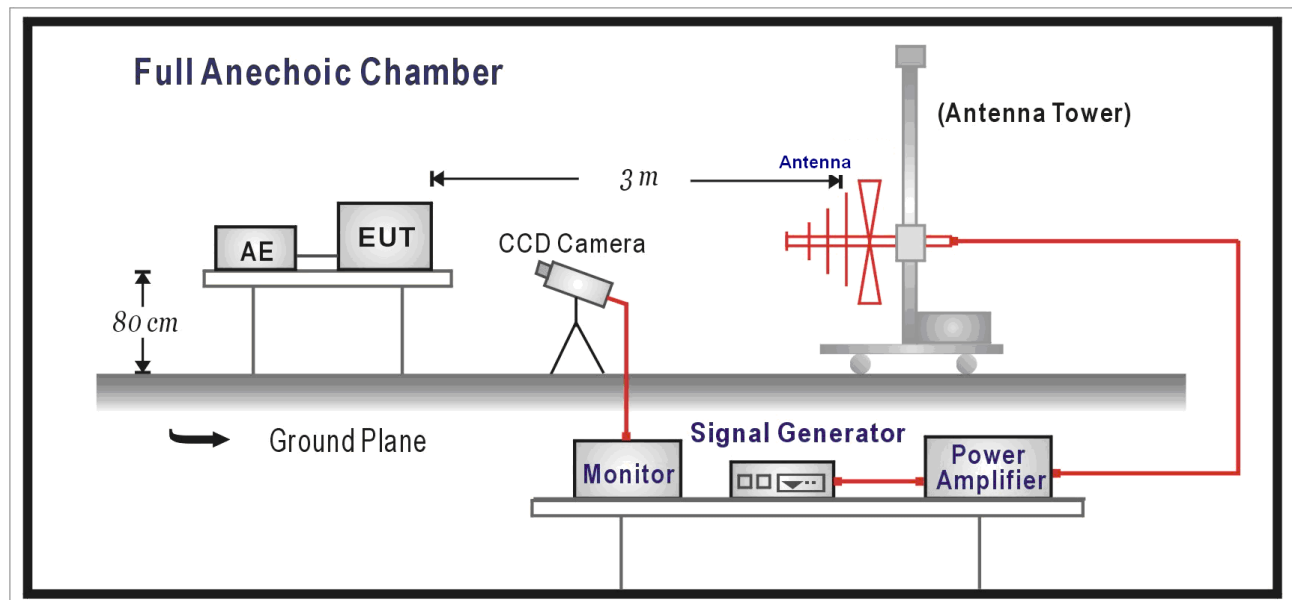

#### 4.6.3 Test Procedure

The test procedure was in accordance with EN 61000-4-3

- The testing was performed in a fully anechoic chamber. The transmit antenna was located at a distance of 3 meters from the EUT.
- The frequency range is swept from 80 MHz to 1 GHz, with the signal 80% amplitude modulated with a 1kHz sine-wave. The rate of sweep did not exceed  $1.5 \times 10^{-3}$  decade/s, where the frequency range is swept incrementally, the step size was 1% of preceding frequency value.
- The dwell time at each frequency shall be not less than the time necessary for the EUT to be able to respond.
- The test was performed with the EUT exposed to both vertically and horizontally polarized fields on each of the four sides.



4.6.4 Test Results

Test Mode: Mode 1				
Frequency (MHz)	Polarity	Field Strength (V/m)	Performance Criterion	Verdict
80 ~ 1000	H	3	<input checked="" type="checkbox"/> A <input type="checkbox"/> B	PASS
80 ~ 1000	V	3	<input checked="" type="checkbox"/> A <input type="checkbox"/> B	PASS
1800	H	3	<input checked="" type="checkbox"/> A <input type="checkbox"/> B	PASS
1800	V	3	<input checked="" type="checkbox"/> A <input type="checkbox"/> B	PASS
2600	H	3	<input checked="" type="checkbox"/> A <input type="checkbox"/> B	PASS
2600	V	3	<input checked="" type="checkbox"/> A <input type="checkbox"/> B	PASS
3500	H	3	<input checked="" type="checkbox"/> A <input type="checkbox"/> B	PASS
3500	V	3	<input checked="" type="checkbox"/> A <input type="checkbox"/> B	PASS
5000	H	3	<input checked="" type="checkbox"/> A <input type="checkbox"/> B	PASS
5000	V	3	<input checked="" type="checkbox"/> A <input type="checkbox"/> B	PASS

Note 1: The testing performed is from lowest level up to the highest level as required by standard, but only highest level is shown on the report.

Criterion A: Operate as intended during and after the test

Criterion B: Operate as intended after the test

Criterion C: Loss/Error of function

### 4.8. Electrical Fast Transient/Burst (EFT)

#### 4.7.1 Test Specification

EN 61000-4-4				
Item	Environmental Phenomena	Units	Test Specification	Performance Criterion
I/O and communication ports				
	Fast Transients Common Mode	kV (Peak) Tr/Th ns Rep. Frequency kHz	$\pm 0.5$ 5/50 5	B
Input DC Power Ports				
	Fast Transients Common Mode	kV (Peak) Tr/Th ns Rep. Frequency kHz	$\pm 0.5$ 5/50 5	B
Input AC Power Ports				
	Fast Transients Common Mode	kV (Peak) Tr/Th ns Rep. Frequency kHz	$\pm 1$ 5/50 5	B

#### 4.7.2 Test Configuration

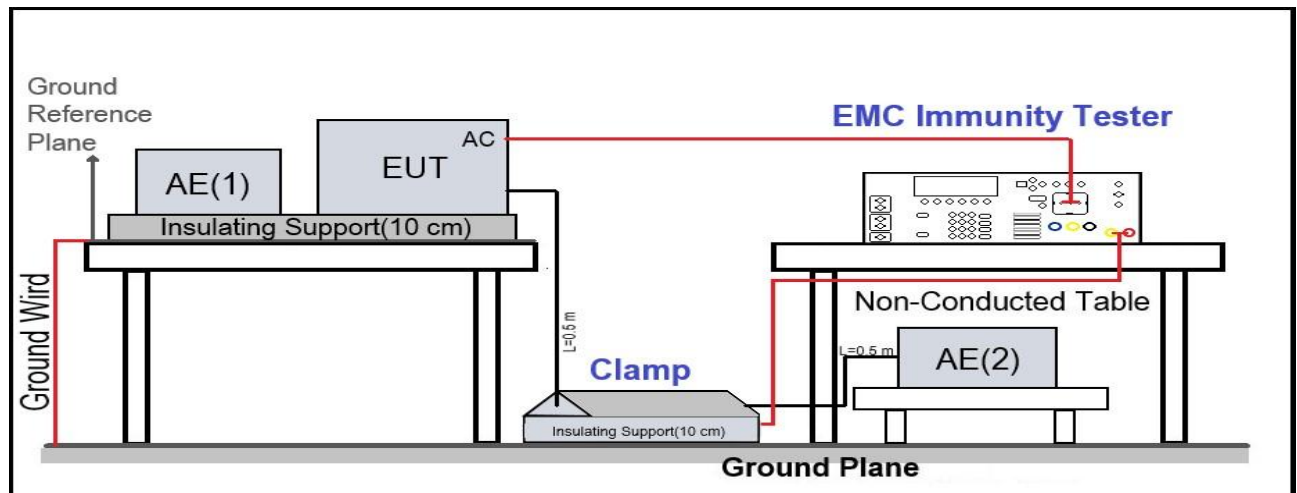

#### 4.7.3 Test Procedure

- Both positive and negative polarity discharges were applied.
- The length of the “hot wire” from the coaxial output of the EFT generator to the terminals on the EUT should not exceed 1 meter.
- The duration time of each test sequential was 1 minute.
- The transient/burst waveform was in accordance with EN 61000-4-4, 5/50ns.

4.7.4 Test Results

Test Mode: Mode 1						
Test Point	Polarity	Test Level (kV)	Inject Time (Second)	Inject Method	Performance Criterion	Verdict
L	±	1	60	Direct	<input checked="" type="checkbox"/> A <input type="checkbox"/> B	PASS
N	±	1	60	Direct	<input checked="" type="checkbox"/> A <input type="checkbox"/> B	PASS
L-N	±	1	60	Direct	<input checked="" type="checkbox"/> A <input type="checkbox"/> B	PASS

Note 1: The testing performed is from lowest level up to the highest level as required by standard, but only highest level is shown on the report.

Criterion A: Operate as intended during and after the test

Criterion B: Operate as intended after the test

Criterion C: Loss/Error of function

## 4.9. Surge

### 4.8.1 Test Specification

EN 61000-4-5				
Item	Environmental Phenomena	Units	Test Specification	Performance Criterion
Signal Ports and Telecommunication Ports				
Surges Line to Ground		Tr/Th us kV	10/700 (5/320) ± 1 (Note)	B
Input DC Power Ports				
Surges Line to Ground		Tr/Th us kV	1.2/50 (8/20) ± 0.5	B
Input AC Power Ports				
Surges Line to Line Line to Ground		Tr/Th us kV kV	1.2/50 (8/20) ± 1 ± 2	B

Note: Where the coupling network for the 10/700  $\mu$ s waveform affects the functioning of high speed data ports, the test shall be carried out using a 1,2/50 (8/20)  $\mu$ s waveform and appropriate coupling

### 4.8.2 Test Configuration

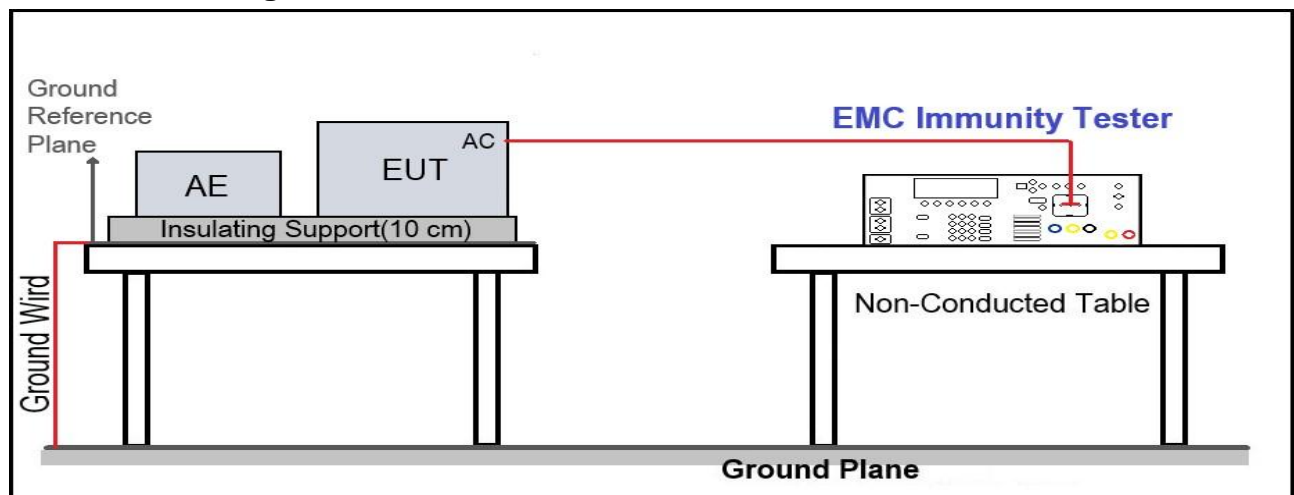

### 4.8.3 Test Procedure

- For EUT power supply:  
The surge is applied to the EUT power supply terminals via the capacitive coupling network. Decoupling networks are required in order to avoid possible adverse effects on equipment not under test that may be powered by the same lines, and to provide sufficient decoupling impedance to the surge wave. The power cord between the EUT and the coupling/decoupling networks was shorter than 2 meters in length.
- For test applied to unshielded un-symmetrically operated interconnection lines of EUT:  
The surge was applied to the lines via the capacitive coupling. The coupling / decoupling networks didn't influence the specified functional conditions of the EUT. The interconnection line between the EUT and the coupling/decoupling networks was shorter than 2 meters in length.
- For test applied to unshielded symmetrically operated interconnection / telecommunication lines of EUT:  
The surge was applied to the lines via gas arrestors coupling. Test levels below the ignition point of the coupling arrester were not specified. The interconnection line between the EUT and the coupling/decoupling networks was shorter than 2 meters in length.

#### 4.8.4 Test Results

Test Mode: Mode 1						
Angle: 0, 90, 180, 270						
Inject Line	Polarity	Voltage (kV)	Time Interval (Second)	Inject Method	Performance Criterion	Verdict
L-N	±	1	60	Direct	<input checked="" type="checkbox"/> A <input type="checkbox"/> B	Pass

Note 1: The testing performed is from lowest level up to the highest level as required by standard, but only highest level is shown on the report.

Criterion A: Operate as intended during and after the test

Criterion B: Operate as intended after the test

Criterion C: Loss/Error of function

### 4.10. Conducted Susceptibility (CS)

#### 4.9.1 Test Specification

EN 61000-4-6					
Environmental Phenomena	Units	Test Specification			Performance Criterion
Signal Ports and Telecommunication Ports					
Radio-Frequency Continuous Conducted	MHz	0.15 to10	10 to 30	30 to 80	A
	V (rms, Un-modulated)	3	3 to 1	1	
	% AM (1 kHz)	80			
Input DC Power Ports					
Radio-Frequency Continuous Conducted	MHz	0.15 to10	10 to 30	30 to 80	A
	V (rms, Un-modulated)	3	3 to 1	1	
	% AM (1 kHz)	80			
Input AC Power Ports					
Radio-Frequency Continuous Conducted	MHz	0.15 to10	10 to 30	30 to 80	A
	V (rms, Un-modulated)	3	3 to 1	1	
	% AM (1 kHz)	80			

EUT tested in accordance with the specifications given by the standard of EN 61000-4-6.

Step : 1%

Step time : 3 Second

#### 4.9.2 Test Configuration

##### CDN Method

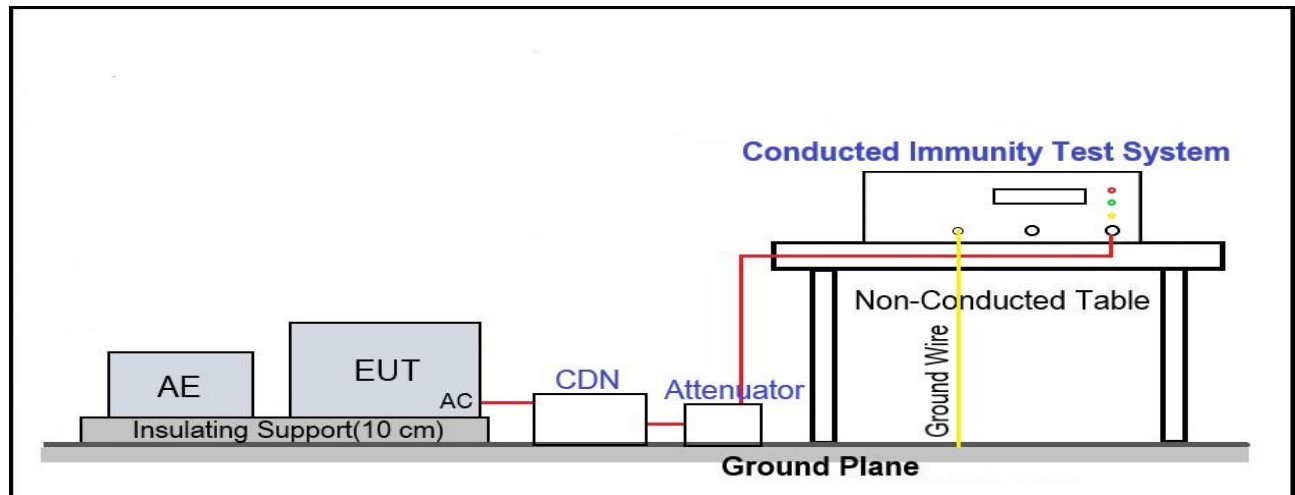

**EM Clamp Method**

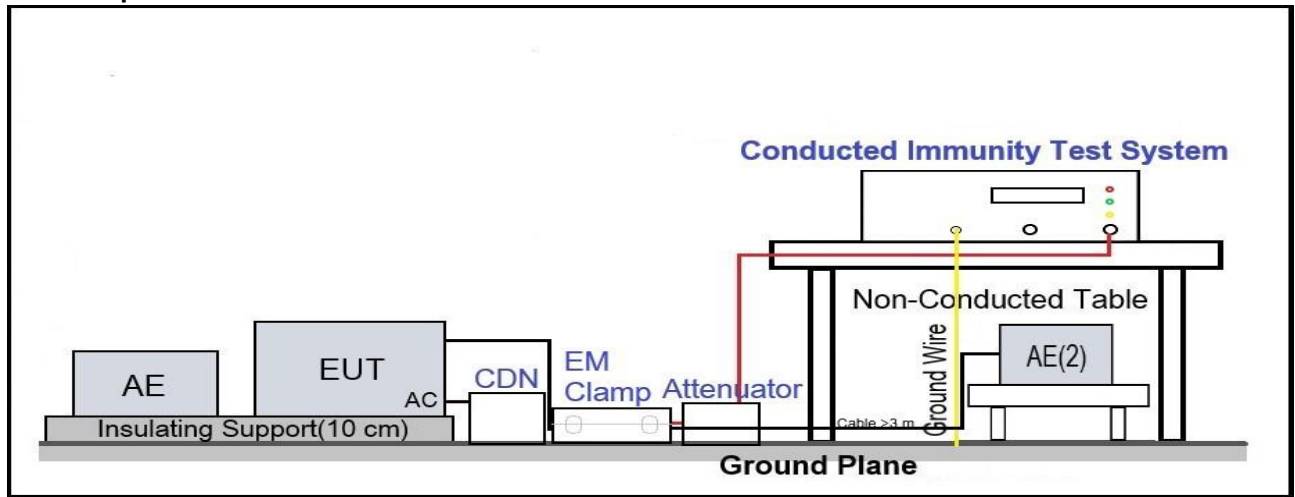

**4.9.3 Test Procedure**

The EUT shall be tested within its intended operating and climatic conditions.

The test shall be performed with the test generator connected to each of the coupling and decoupling devices in turn, while the other non-excited RF input ports of the coupling devices are terminated by a 50-ohm load resistor.

The frequency range was swept from 150 kHz to 80 MHz, using the signal level established during the setting process and with a disturbance signal of 80 % amplitude. The signal was modulated with a 1 kHz sine wave, pausing to adjust the RF signal level or the switch coupling devices as necessary. The sweep rate was  $1.5 \times 10^{-3}$  decades/s. Where the frequency range is swept incrementally, the step size was 1 % of preceding frequency value from 150 kHz to 80 MHz.

The dwell time at each frequency was less than the time necessary for the EUT to be exercised, and able to respond. Sensitive frequencies such as clock frequency and harmonics or frequencies of dominant interest, was analyzed separately.

Attempts were made to fully exercise the EUT during testing, and to fully interrogate all exercise modes selected for susceptibility.

**4.9.4 Test Results**

Test Mode: Mode 1					
Frequency Band (MHz)	Field Strength (Vrms)	Inject Port	Inject Method	Performance Criterion	Verdict
0.15 ~ 10	3	AC Mains	CDN-M3	<input checked="" type="checkbox"/> A <input type="checkbox"/> B	PASS
10 ~ 30	3 to 1			<input checked="" type="checkbox"/> A <input type="checkbox"/> B	PASS
30 ~ 80	1			<input checked="" type="checkbox"/> A <input type="checkbox"/> B	PASS

Note 1: The testing performed is from lowest level up to the highest level as required by standard, but only highest level is shown on the report.

Criterion A: Operate as intended during and after the test

Criterion B: Operate as intended after the test

Criterion C: Loss/Error of function

### 4.11. Power Frequency Magnetic Field (PMF)

#### 4.10.1 Test Specification

EN 61000-4-8				
Item	Environmental Phenomena	Units	Test Specification	Performance Criterion
Enclosure Port				
	Power-Frequency Magnetic Field	Hz A/m (r.m.s.)	50 1	A

EUT tested in accordance with the specifications given by the standard of EN 61000-4-8.

Orientation : X, Y, Z

Test time : 180 Second

#### 4.10.2 Test Configuration

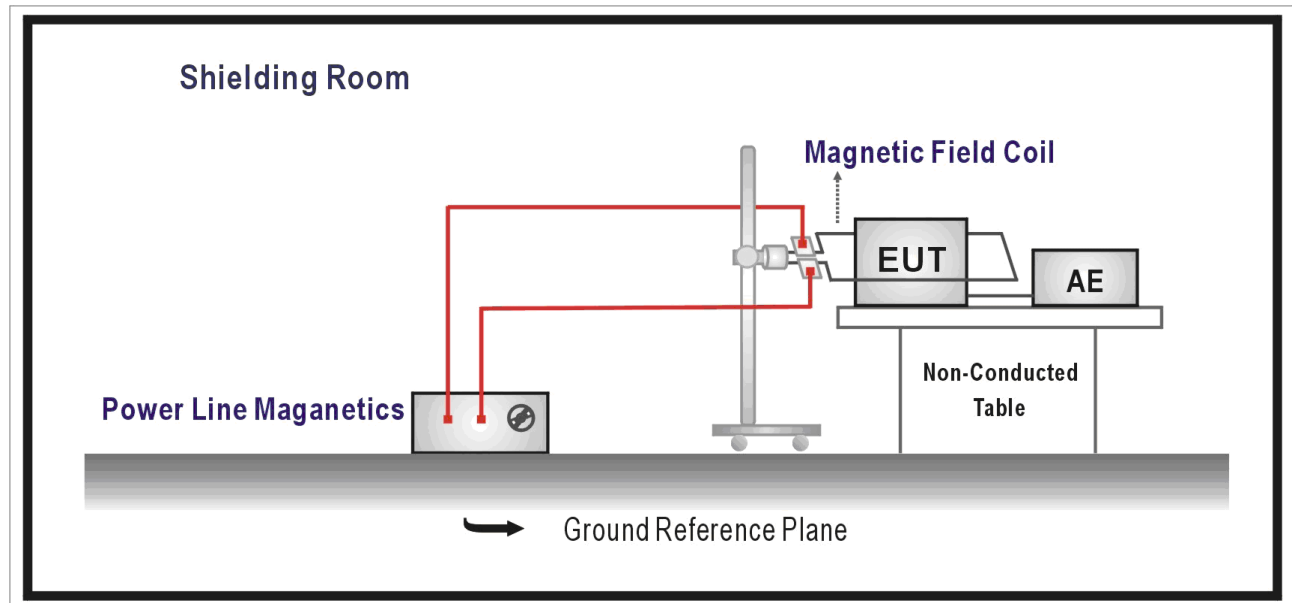

#### 4.10.3 Test Procedure

- The equipment was configured and connected to satisfy its functional requirements. It shall be placed on the GRP with the interposition of a 0.1m-thick insulating support.
- The equipment cabinets shall be connected to the safety earth directly on the GRP via the earth terminal of the EUT.
- The power supply, input and output circuits shall be connected to the sources of power supply, control and signal.
- The cables supplied or recommended by the equipment manufacturer shall be used. 1 meter of all cables used shall be exposed to the magnetic field.
- The EUT is tested in three antenna appositions (Front, top, and side) for 1 minutes each.



**4.10.4 Test Results**

Test Mode: Mode 1					
Polarization	Frequency (Hz)	Magnetic Strength (A/m)	Duration (s)	Performance Criterion	Verdict
X Orientation	50	1	60	<input checked="" type="checkbox"/> A <input type="checkbox"/> B	PASS
Y Orientation	50	1	60	<input checked="" type="checkbox"/> A <input type="checkbox"/> B	PASS
Z Orientation	50	1	60	<input checked="" type="checkbox"/> A <input type="checkbox"/> B	PASS

Note 1: The testing performed is from lowest level up to the highest level as required by standard, but only highest level is shown on the report.

Criterion A: Operate as intended during and after the test

Criterion B: Operate as intended after the test

Criterion C: Loss/Error of function

## 4.12. Voltage Dips and Interruptions

### 4.11.1 Test Specification

EN 61000-4-11			
Environmental Phenomena	Units	Test Specification	Performance Criterion
Input AC Power Ports			
Voltage Dips	>95	% Reduction	B
	0.5	Period	
	30	% Reduction	C
	25	Period	
Voltage Interruptions	>95	% Reduction	C
	250	Period	

### 4.11.2 Test Configuration

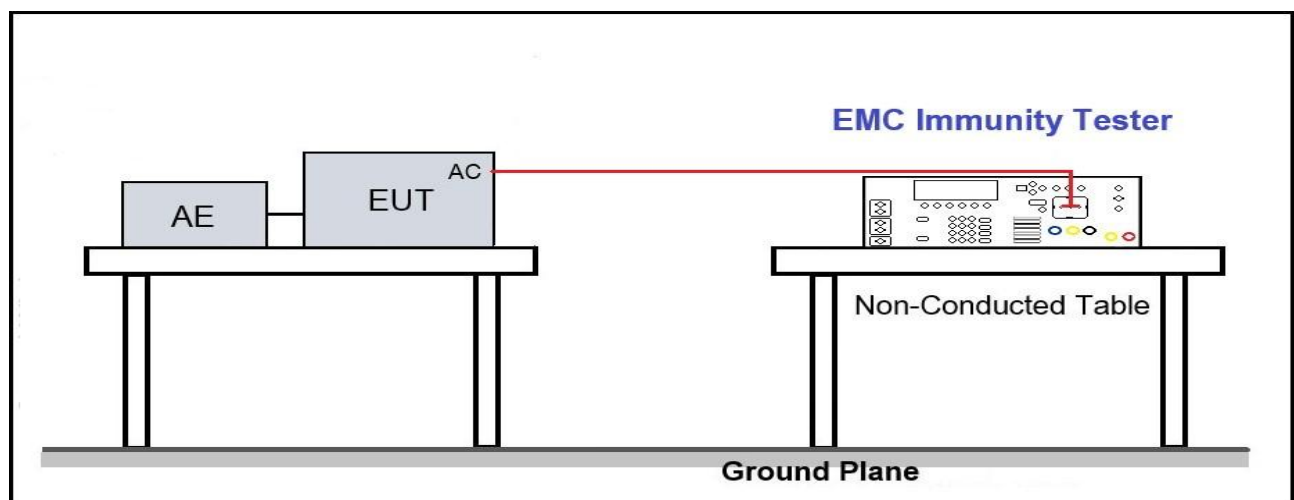

### 4.11.3 Test Procedure

The Section of EN 61000-4 defines the immunity test methods and range of preferred test levels for electrical and electronic equipment connected to low-voltage power supply networks for voltage dips, short interruptions and voltage variations. The standard applies to electrical and electronic equipment having a rated input current not exceeding 16A per phase. It does not apply to electrical and electronic equipment for connection to D.C networks or 400Hz A.C networks. Test for these networks will be covered by future EN standard. A performance criterion is classified as A, B, C, the recommendation is criterion A or B.

The test shall be performed with the EUT connected to the test generator with the shortest power supply cable as specified by EUT manufacturer. If no cable length is specified, it shall be the shortest possible length suitable to the application of the EUT.

The test set-up for the two types of phenomena described in this standard are:

- Voltage dips and short interruptions;
- Voltage variations with gradual transition between the rated voltage and the changed voltage (Option)

Both tests may be implemented with this set-up. Test on the three-phase EUT are accomplished by using three set of equipment mutually synchronized.

The EUT shall be tested for each selected combination of test level and duration with a sequence of three Dip / interruption with intervals of 10 s minimum (between each test event). Each representative mode of operation shall be tested.

4.11.4 Test Results

Test Mode: Mode 1				
Angle: 0, 45, 90, 135, 180, 225, 270, 315				
Test Voltage (Vac)	Voltage Reduction (%)	Test Duration (Periods)	Performance Criterion	Verdict
230	>95	0.5	<input checked="" type="checkbox"/> A <input type="checkbox"/> B <input type="checkbox"/> C	Note 1
	30	25	<input checked="" type="checkbox"/> A <input type="checkbox"/> B <input type="checkbox"/> C	Note 1
	>95	250	<input type="checkbox"/> A <input type="checkbox"/> B <input checked="" type="checkbox"/> C	Note 2
100	>95	0.5	<input checked="" type="checkbox"/> A <input type="checkbox"/> B <input type="checkbox"/> C	Note 1
	30	25	<input checked="" type="checkbox"/> A <input type="checkbox"/> B <input type="checkbox"/> C	Note 1
	>95	250	<input type="checkbox"/> A <input type="checkbox"/> B <input checked="" type="checkbox"/> C	Note 2

Note 1: The testing performed is from lowest level up to the highest level as required by standard, but only highest level is shown on the report.

Criterion A: Operate as intended during and after the test

Criterion B: Operate as intended after the test

Criterion C: Loss/Error of function

Note2: The power is temporary off and can be reset by the operator.

## 5. TEST SETUP PHOTOS OF THE EUT

Radiated Emission

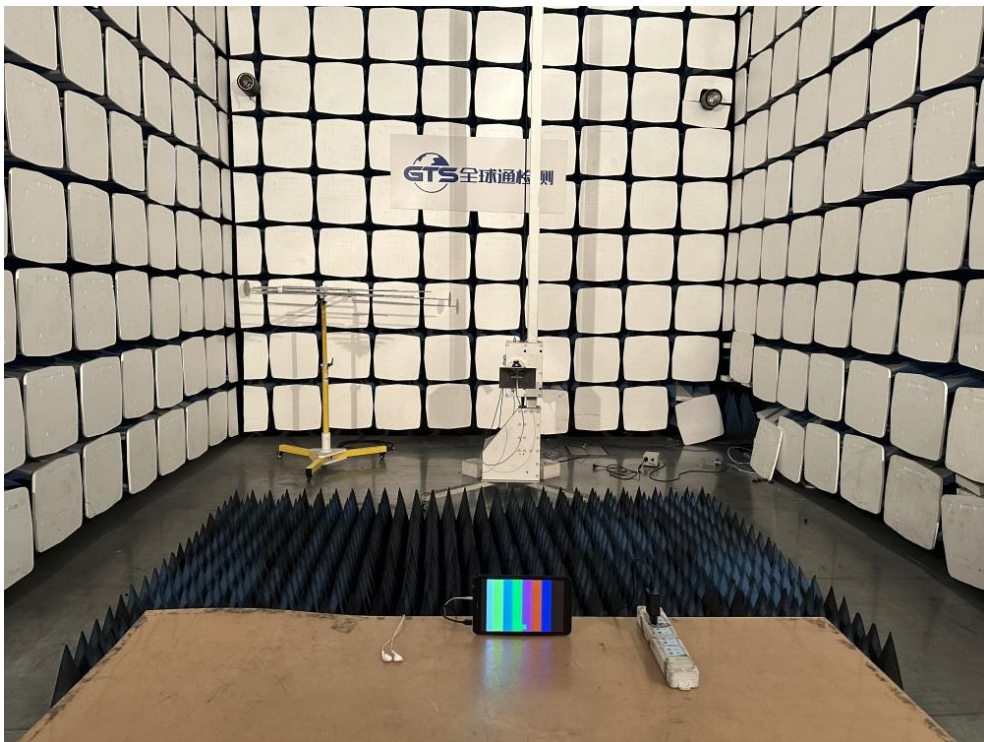
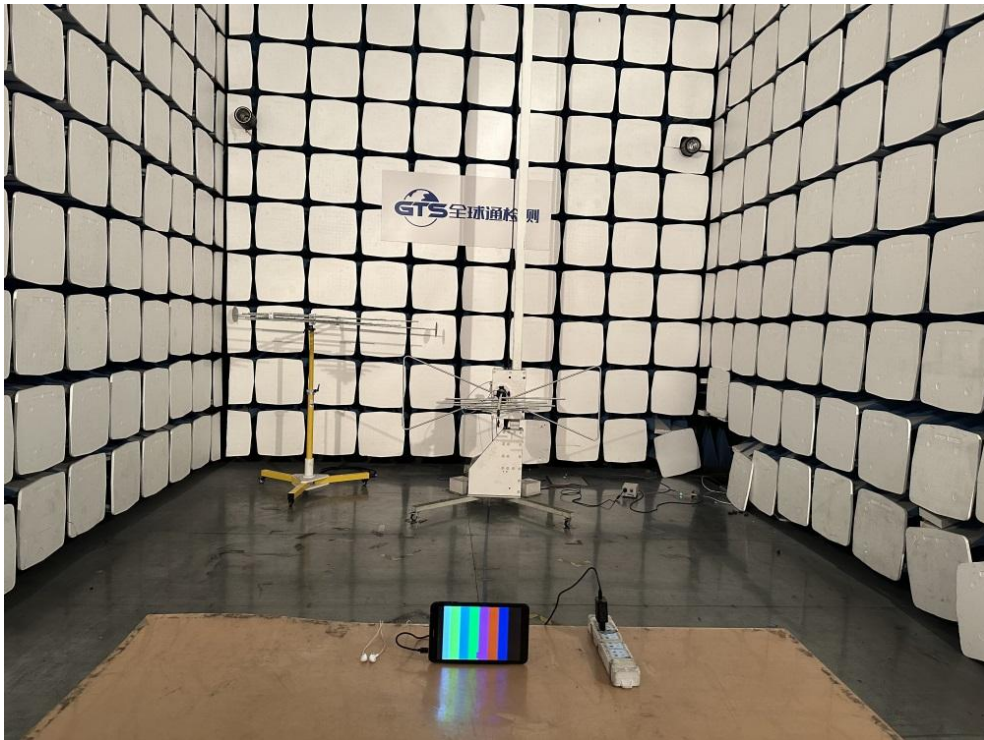

Conducted Emission( AC Mains)

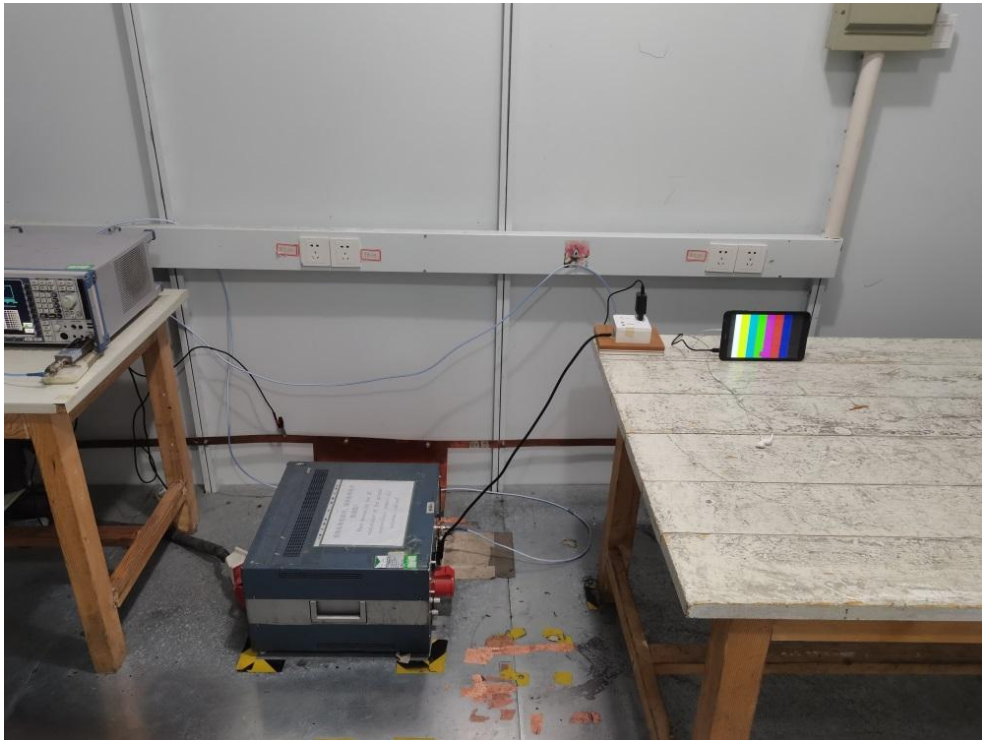

Harmonic Current/ Voltage Fluctuation and Flicker



Electrostatic Discharge



RF Electromagnetic Field

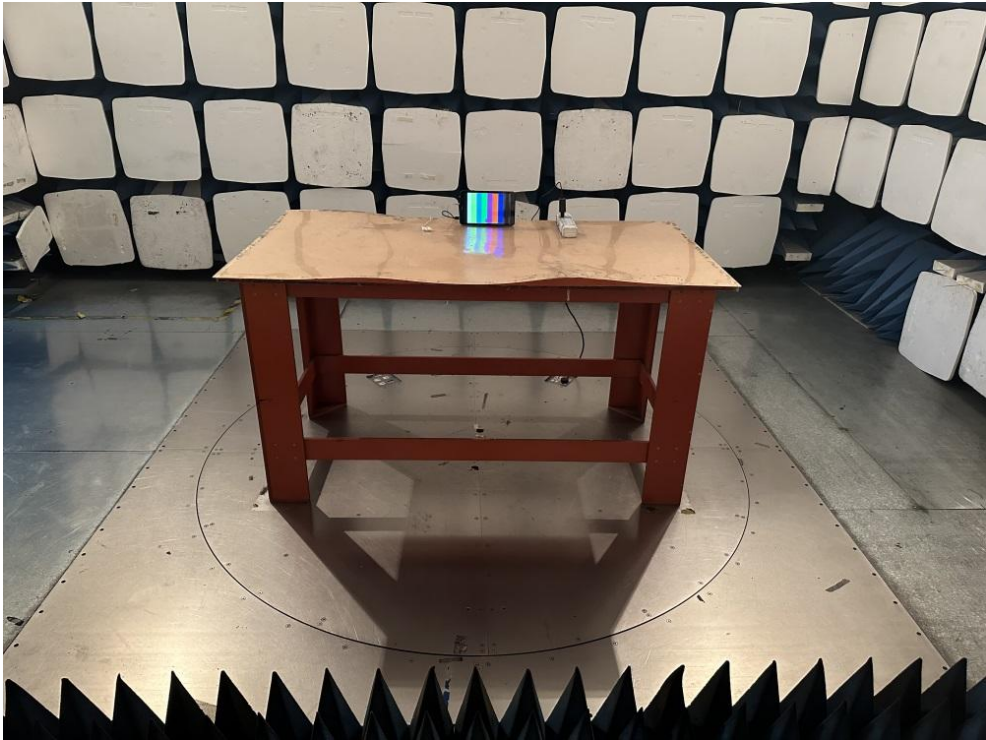

RF Common Mode 0,15 MHz to 80 MHz



Fast Transients Common Mode & Surge & DIPS



## 6. PHOTOS OF THE EUT



Fig. 1



Fig. 2



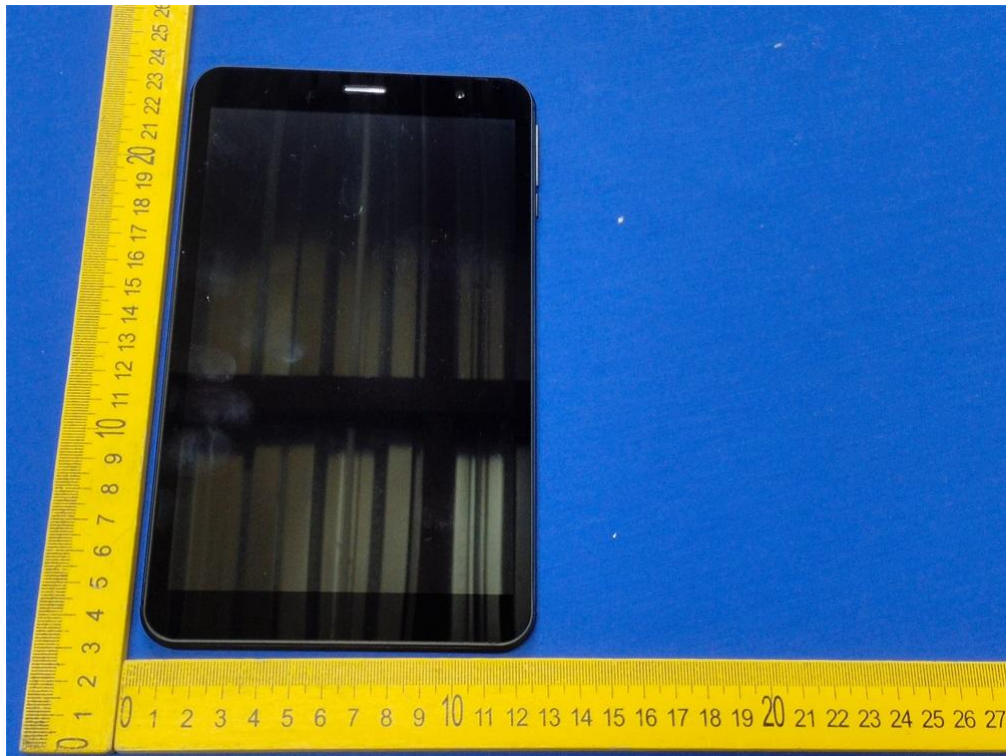

Fig. 3



Fig. 4



Fig. 5



Fig. 6



Fig. 7



Fig. 8



Fig. 9



Fig. 10

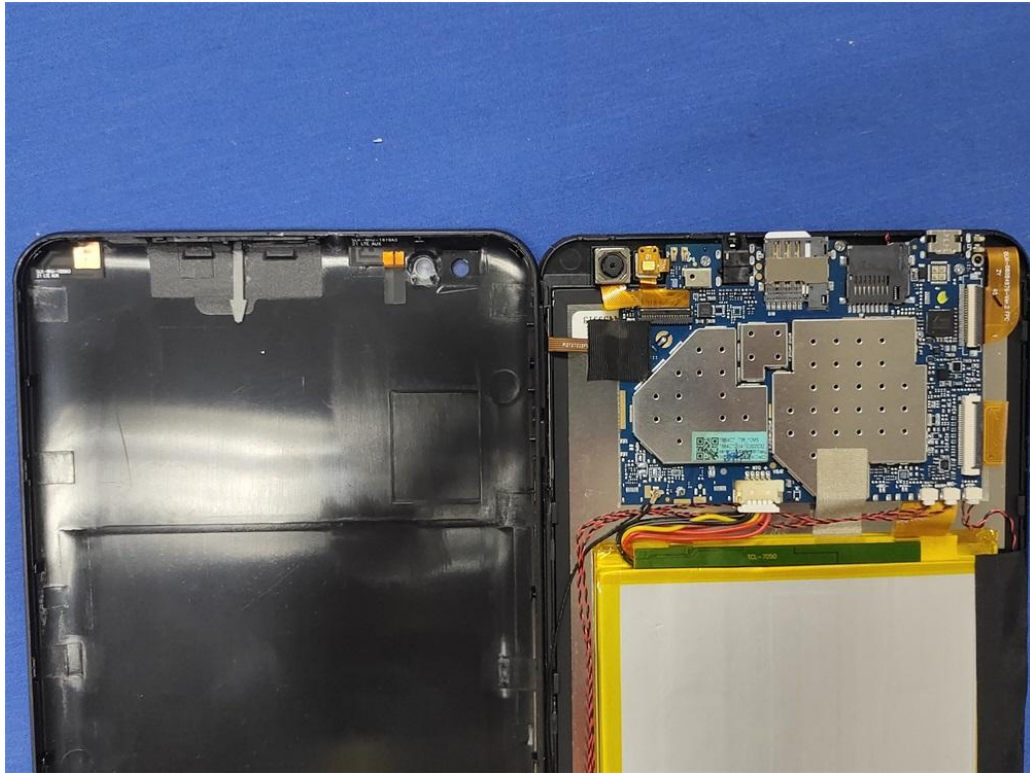

Fig. 11

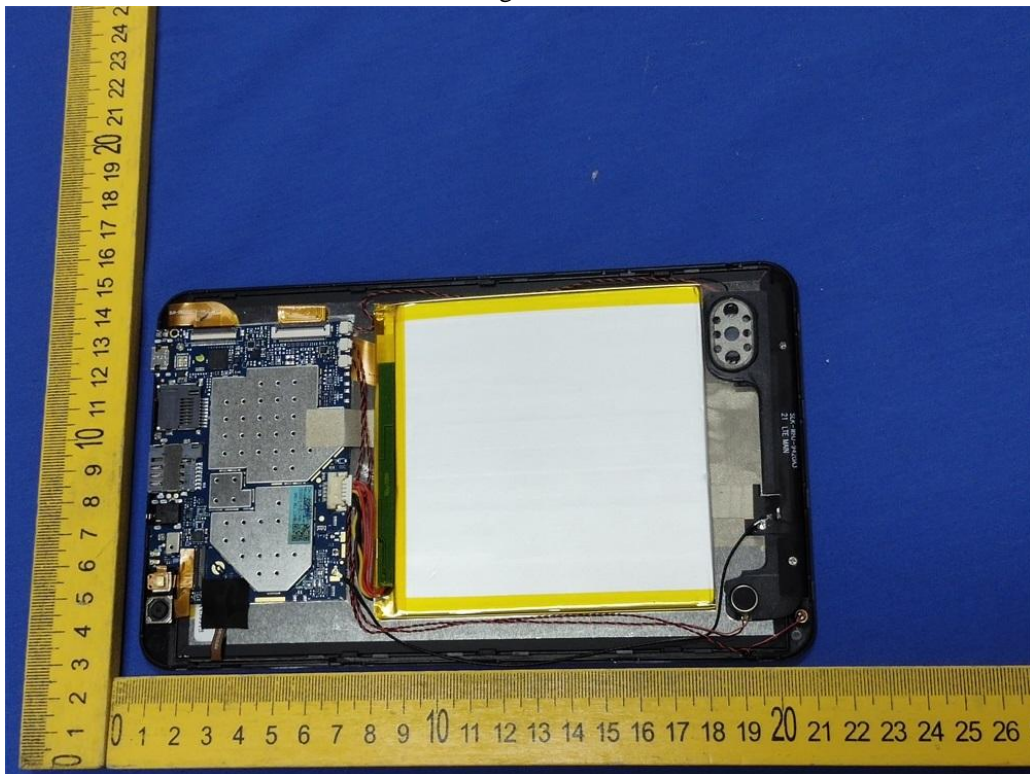

Fig. 12

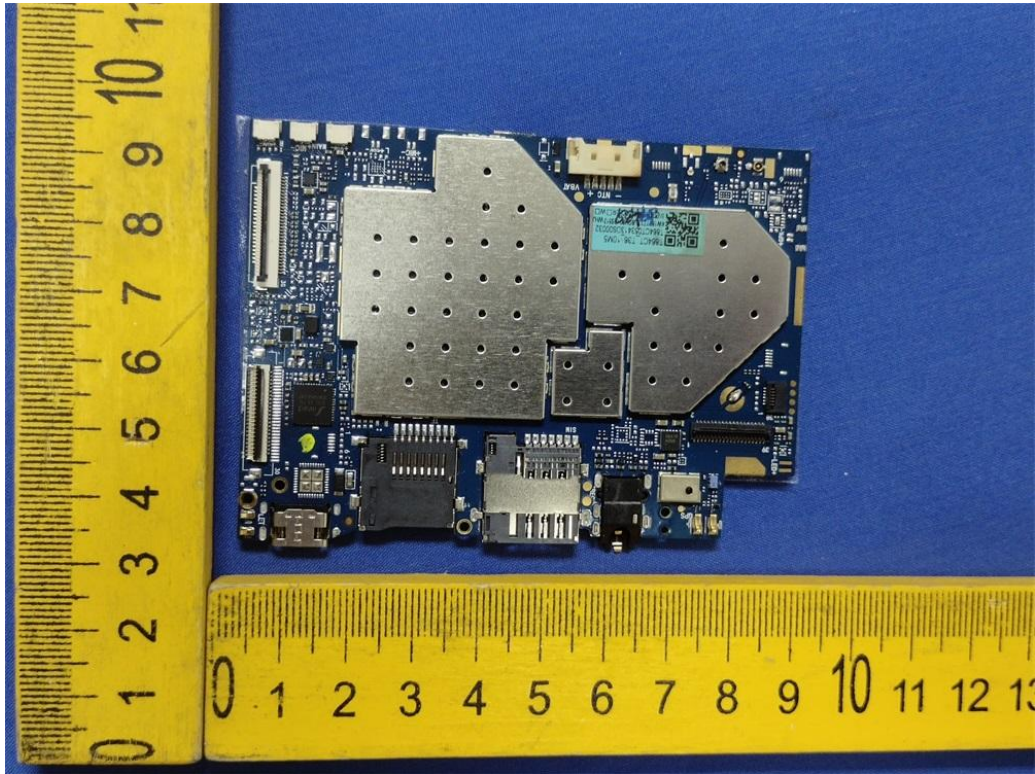

Fig. 13

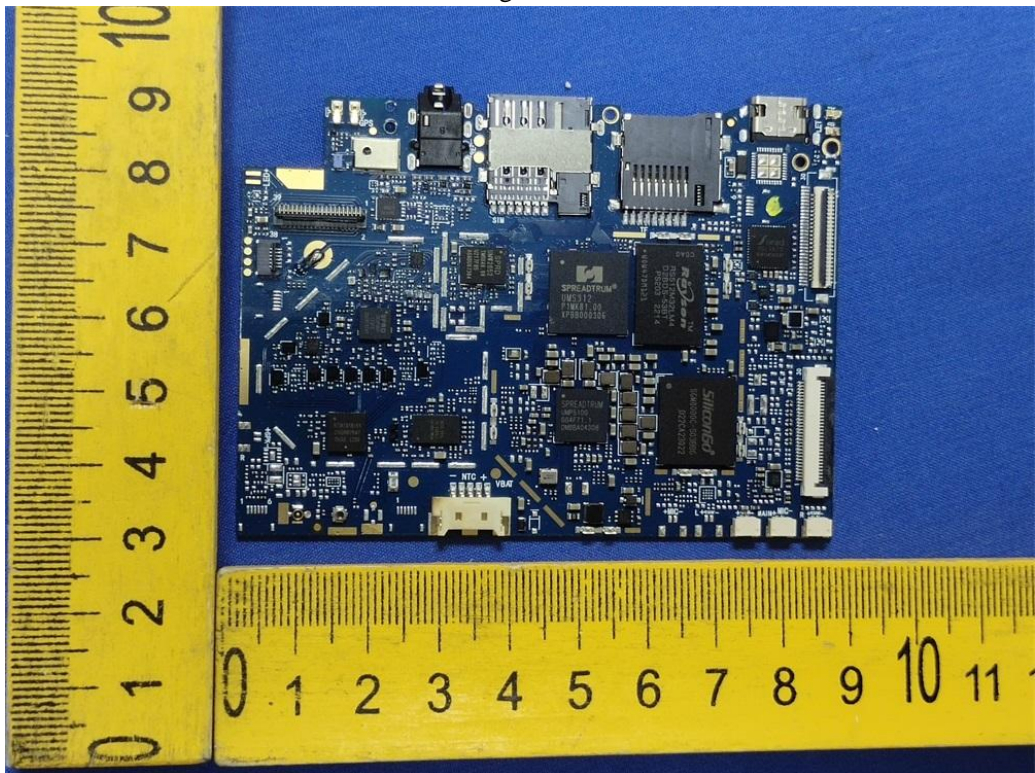

Fig. 14

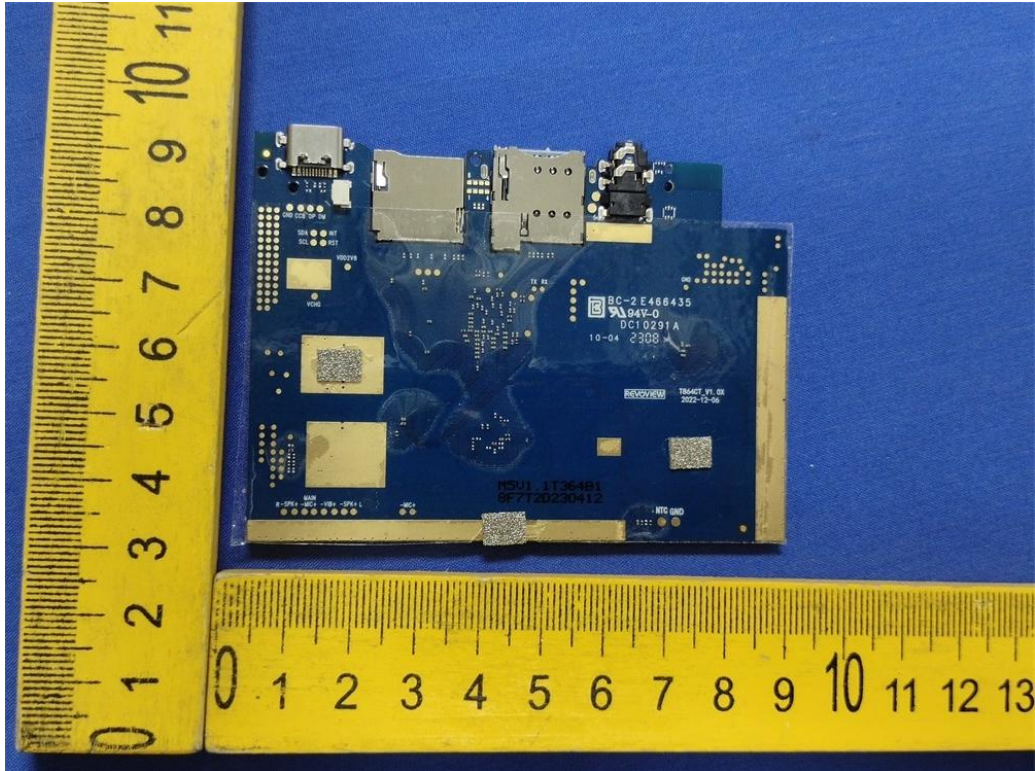

Fig. 15

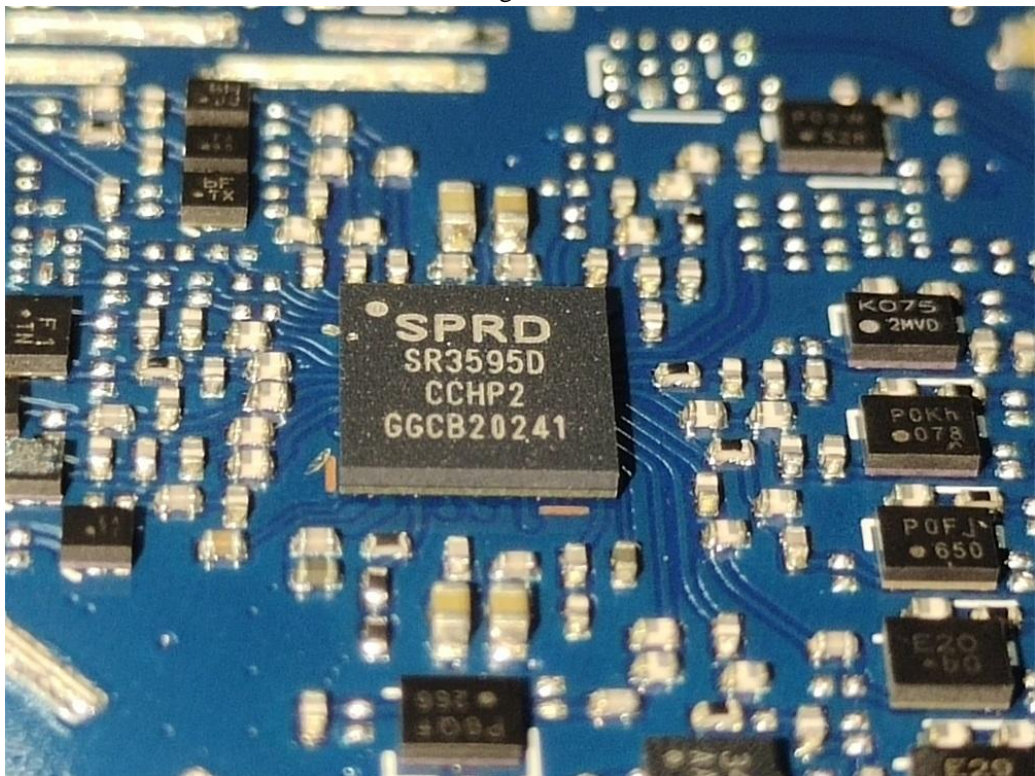

Fig. 16



Fig. 17



Fig. 18



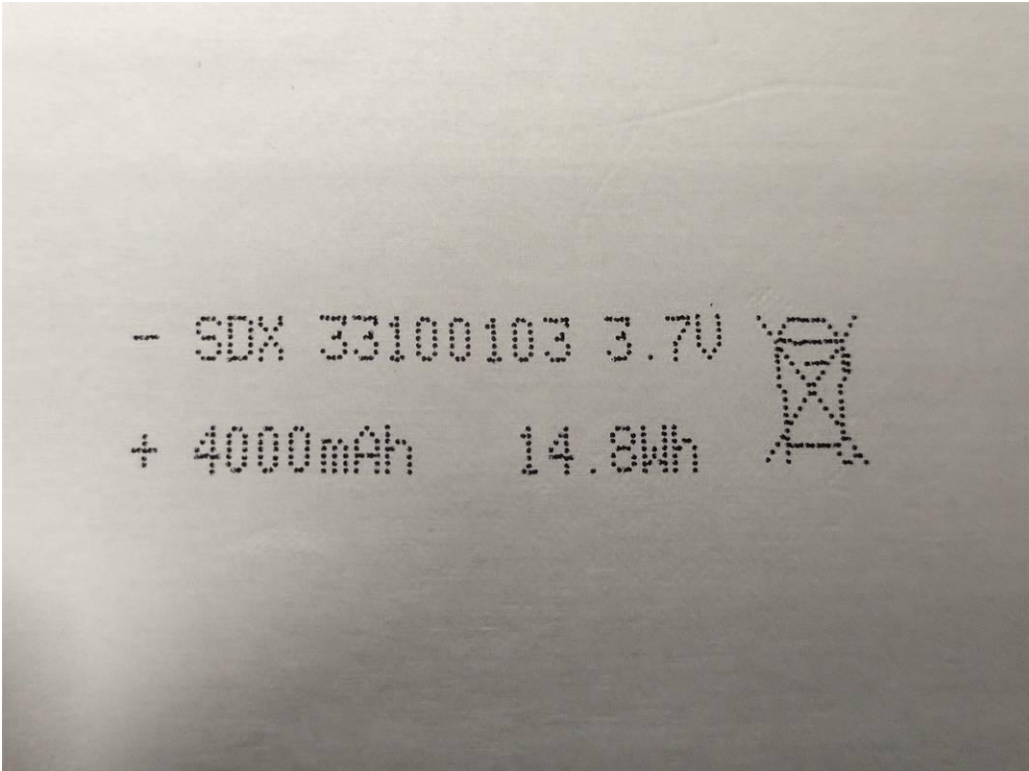

Fig. 19

.....End of Report.....