

INSTRUCTION MANUAL

MICROWAVE OVEN

MW-MM20P(BK)/MW-MM20P(WH)

Please review this instruction manual before operating.

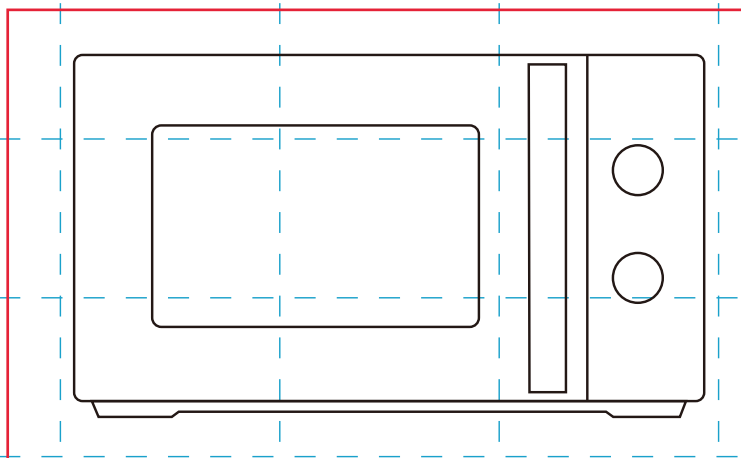

LANGUAGES

EN English

IT Italian

ES Spanish

EL Greece

PT Portugal

SR Serbia

BG Bulgaria

HR Croatia

LV Latvian

CONTENTS

PRODUCT SAFETY

Precautions to avoid possible exposure to excessive microwave energy	EN-01
Important safety instructions	EN-03
To reduce the risk of injury to persons grounding installation.....	EN-07
Cleaning.....	EN-09
Utensils.....	EN-10
Materials you can use in microwave oven	EN-11
Materials can not be used in microwave oven	EN-13

PRODUCT SETTING

Setting up your oven	EN-14
----------------------------	-------

INSTRUCTION FOR USE

Before using for the first time	EN-18
Operation	EN-19
Cleaning.....	EN-21

MAINTENANCE

Troubleshooting	EN-23
-----------------------	-------



NOTE

BEFORE OPERATING THIS PRODUCT, READ, UNDERSTAND, AND FOLLOW THESE INSTRUCTIONS. BE SURE TO SAVE THIS BOOKLIST FOR FUTURE REFERENCE.

PRECAUTIONS TO AVOID POSSIBLE EXPOSURE TO EXCESSIVE MICROWAVE ENERGY

- (a). Do not attempt to operate this oven with the door open since this can result in harmful exposure to microwave energy. It is important not to break or tamper with the safety interlocks.

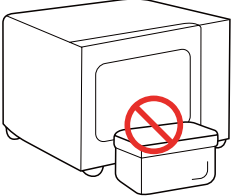
 - (b). Do not place any object between the oven front face and the door or allow soil or cleaner residue to accumulate on sealing surfaces.
- 
- (c). **WARNING:** If the door or door seals are damaged, the oven must not be operated until it has been repaired by a competent person.

ADDENDUM

If the apparatus is not maintained in a good state of cleanliness, its surface could be degraded and affect the lifespan of the apparatus and lead to a dangerous situation.

SPECIFICATIONS

MODEL	MW-MM20P(BK)/MW-MM20P(WH)
RATED VOLTAGE/FREQUENCY	230-240V~ 50Hz
RATED INPUT POWER (MICROWAVE)	1200-1270 W
RATED OUTPUT POWER (MICROWAVE)	750-800 W



NOTE

All pictures in this manual are for illustrative purposes only; these may be slightly different from the purchased equipment, please refer to the actual product.

IMPORTANT SAFETY INSTRUCTIONS



WARNING

To reduce the risk of fire, electric shock, injury to persons or exposure to excessive microwave oven energy when using your appliance, follow basic precautions, including the following:



Read and follow the specific: "**PRECAUTIONS TO AVOID POSSIBLE EXPOSURE TO EXCESSIVE MICROWAVE ENERGY**".



This appliance can be used by children aged from 8 years and above and persons with reduced physical, sensory or mental capabilities or lack of experience and knowledge if they have been given supervision or instruction concerning use of the appliance in a safe way and understand the hazards involved. Children shall not play with the appliance. Cleaning and user

maintenance shall not be made by children without supervision.



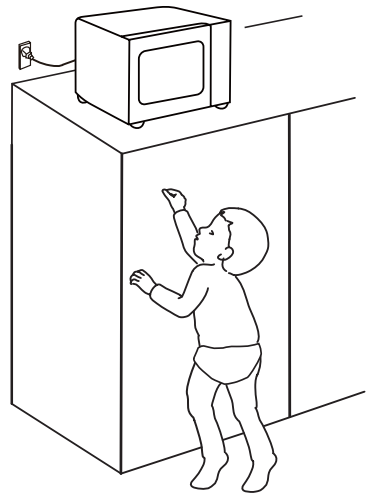

Keep the appliance and its cord out of reach of children less than 8 years.





IMPORTANT SAFETY INSTRUCTIONS

 If the supply cord is damaged, it must be replaced by the manufacturer, its service agent or similarly qualified persons in order to avoid a hazard.

 **WARNING:** Ensure that the appliance is switched off before replacing the lamp to avoid the possibility of electric shock.

 **WARNING:** It is hazardous for anyone other than a competent person to carry out any service or repair operation that involves the removal of a cover which gives protection against exposure to microwave energy.

 **WARNING:** Liquids and other foods must not be heated in sealed containers since they are liable to explode.

 When heating food in plastic or paper containers, keep an eye on the oven due to the possibility of ignition.



 Only use utensils that are suitable for use in microwave ovens.

 If smoke is emitted, switch off or unplug the appliance and keep the door closed in order to stifle any flames.

 Microwave heating of beverages can result in delayed eruptive boiling, therefore care must be taken when handling the container.

 The contents of feeding bottles and baby food jars shall be stirred or shaken and the temperature

IMPORTANT SAFETY INSTRUCTIONS

checked before consumption, in order to avoid burns.

 The oven should be cleaned regularly and any food deposits removed. Please keep the waveguide area clean. Use soft damp cloth to clean it up when there is food splash residue on the waveguide area or the cavity. Failure to clean food residue may cause innocuous sparking or some smoke in the microwave cavity, discoloration of the cavity may also occur.

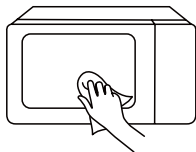

 Failure to maintain the oven in a clean condition could lead to deterioration of the surface that could

adversely affect the life of the appliance and possibly result in a hazardous situation.

 Only use the temperature probe recommended for this oven. (for ovens provided with a facility to use a temperature-sensing probe.)

 The microwave oven must be operated with the decorative door open. (for ovens with a decorative door.)

 This appliance is intended to be used in household and similar applications such as:

1. staff kitchen areas in shops, offices and other working environments;
2. by clients in hotels, motels and other residential type environments;
3. farm houses;
4. bed and breakfast type environments.

IMPORTANT SAFETY INSTRUCTIONS

 The microwave oven is intended for heating food and beverages. Drying of food or clothing and heating of warming pads, slippers, sponges, damp cloth and similar may lead to risk of injury, ignition or fire.

 The appliance is intended to be used freestanding.

 The rear surface of appliances shall be placed against a wall.

 Eggs in their shell and whole hard-boiled eggs should not be heated in microwave ovens since they may explode, even after microwave heating has ended.

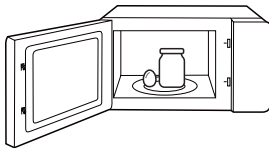

 The appliance must not be installed behind a decorative door in order to avoid overheating. (This is not applicable for appliances with decorative door.)

 The microwave oven shall not be placed in a cabinet.

 Metallic containers for food and beverages are not allowed during microwave cooking.

 The appliance shall not be cleaned with a steam cleaner.

 The appliances are not intended to be operated by means of an external timer or separate remotecontrol system.

**READ CAREFULLY AND KEEP FOR
FUTURE REFERENCE**

TO REDUCE THE RISK OF INJURY TO PERSONS GROUNDING INSTALLATION

This appliance must be grounded. In the event of an electrical short circuit, grounding reduces the risk of electric shock by providing an escape wire for the electric current.

This appliance is equipped with a cord having a grounding wire with a grounding plug. The plug must be plugged into an outlet that is properly installed and grounded.

WARNING - Improper use of the grounding can result in a risk of electric shock. Consult a qualified electrician or serviceman if the grounding instructions are not completely understood or if doubt exists as to whether the appliance is properly grounded.

If it is necessary to use an extension cord, use only a 3-wire extension cord.



DANGER

Electric Shock Hazard:

Touching some of the internal components can cause serious personal injury or death. Do not disassemble this appliance.

TO REDUCE THE RISK OF INJURY TO PERSONS GROUNDING INSTALLATION



WARNING

Electric Shock Hazard:

Improper use of the grounding can result in electric shock. Do not plug into an outlet until appliance is properly installed and grounded.

1. A short power-supply cord is provided to reduce the risks resulting from becoming entangled in or tripping over a longer cord.
2. If a long cord or extension cord is used:
 - (1). The marked electrical rating of the cord set or extension cord should be at least as great as the electrical rating of the appliance.
 - (2). The extension cord must be a grounding-type 3-wire cord.
 - (3). The longer cord should be arranged so that it will not drape over the counter top or tabletop where it can be pulled on by children or tripped over unintentionally.

CLEANING

Be sure to unplug the appliance from the power supply.

1. Clean the cavity of the oven after using with a slightly damp cloth.
2. Clean the accessories in the usual way in soapy water.
3. The door frame and seal and neighbouring parts must be cleaned carefully with a damp cloth when they are dirty.
4. Do not use harsh abrasive cleaners or sharp metal scrapers to clean the oven door glass since they can scratch the surface, which may result in shattering of the glass.
5. Cleaning Tip---For easier cleaning of the cavity walls that the food cooked can touch: Place half a lemon in a bowl, add 300ml (1/2 pint) water and heat on 100% microwave power for 10 minutes. Wipe the oven clean using a soft, dry cloth.

UTENSILS



CAUTION

Personal Injury Hazard:

It is hazardous for anyone other than a competent person to carry out any service or repair operation that involves the removal of a cover which gives protection against exposure to microwave energy.

See the instructions on "**Materials you can use in microwave oven**" or "**Materials can not be used in microwave oven**"

There may be certain non-metallic utensils that are not safe to use for microwaving. If in doubt, you can test the utensil in question following the procedure below.

Utensil Test:

1. Fill a microwave-safe container with 1 cup of cold water (250ml) along with the utensil in question.
2. Cook on maximum power for 1 min.
3. Carefully feel the utensil. If the empty utensil is warm, do not use it for microwave cooking.
4. Do not exceed 1 min cooking time.

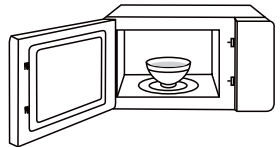





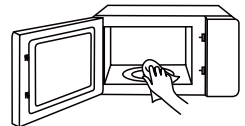











NOTE









KEEP THE CAVITY AND
WAVEGUIDE AREA CLEAN

















MATERIALS YOU CAN USE IN MICROWAVE OVEN

UTENSILS	REMARKS
 Browning dish	Follow manufacturer's instructions. The bottom of browning dish must be at least 3/16 inch (5mm) above the turntable. Incorrect usage may cause the turntable to break. 
 Dinnerware	Microwave-safe only. Follow manufacturer's instructions. Do not use cracked or chipped dishes. 
 Glass jars	Always remove lid. Use only to heat food until just warm. Most glass jars are not heat resistant and may break. 
 Glassware	Heat-resistant oven glassware only. Make sure there is no metallic trim. Do not use cracked or chipped dishes. 
 Oven cooking bags	Follow manufacturer's instructions. Do not close with metal tie. Make slits to allow steam to escape. 
 Paper plates and cups	Use for short-term cooking/warming only. Do not leave oven unattended while cooking. 
 Paper towels	Use to cover food for reheating and absorbing fat. Use with supervision for a short-term cooking only. 
 Parchment paper	Use as a cover to prevent splattering or a wrap for steaming. 

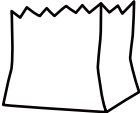
MATERIALS YOU CAN USE IN MICROWAVE OVEN

UTENSILS	REMARKS
 <p data-bbox="163 454 240 478">Plastic</p>	<p data-bbox="349 351 895 494">Microwave-safe only. Follow the manufacturer's instructions. Should be labeled "Microwave Safe". Some plastic containers soften, as the food inside gets hot. "Boiling bags" and tightly closed plastic bags should be slit, pierced or vented as directed by package.</p> 
 <p data-bbox="147 638 262 662">Plastic wrap</p>	<p data-bbox="349 550 895 638">Microwave-safe only. Use to cover food during cooking to retain moisture. Do not allow plastic wrap to touch food.</p> 
 <p data-bbox="131 805 278 829">Thermometers</p>	<p data-bbox="349 742 889 774">Microwave-safe only (meat and candy thermometers).</p> 
 <p data-bbox="152 965 256 989">Wax paper</p>	<p data-bbox="349 893 819 949">Use as a cover to prevent splattering and retain moisture.</p> 

MATERIALS CAN NOT BE USED IN MICROWAVE OVEN

UTENSILS	REMARKS
 Aluminum tray	May cause arcing. Transfer food into microwave-safe dish. 
 Food carton with metal handle	May cause arcing. Transfer food into microwave-safe dish. 
 Metal or metal trimmed utensils	Metal shields the food from microwave energy. Metal trim may cause arcing. 
 Metal twist ties	May cause arcing and could cause a fire in the oven. 
 Paper bags	May cause a fire in the oven. 
 Plastic foam	Plastic foam may melt or contaminate the liquid inside when exposed to high temperature. 
 Wood	Wood will dry out when used in the microwave oven and may split or crack. 

PRODUCT SETTING

SETTING UP YOUR OVEN

NAMES OF MICROWAVE OVEN PARTS AND ACCESSORIES

Remove the oven and all materials from the carton and oven cavity.

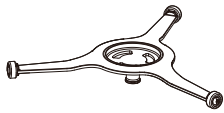

Turntable Ring Assembly



Glass turntable

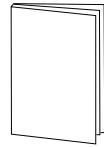

Instruction Manual

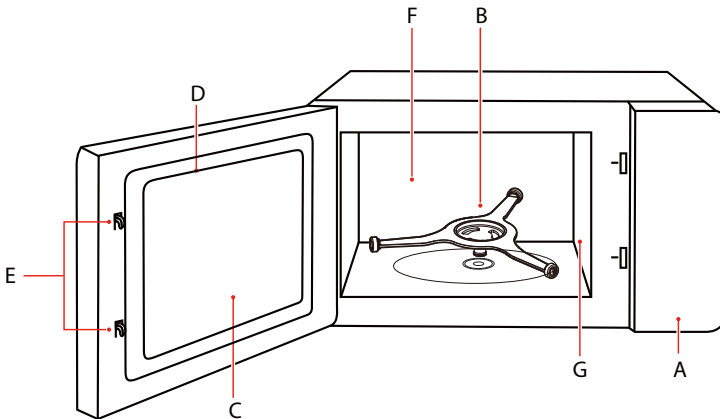

- A. Control panel
- B. Turntable Ring Assembly
- C. Observation window
- D. Door assembly

- E. Safety interlock system
- F. Oven cavity
- G. Waveguide cover

SETTING UP YOUR OVEN

TURNTABLE INSTALLATION

Clean the cooking compartment and place the turntable.

For new installations, make sure all packaging and shipping tape has been removed from the turntable shaft.

Before using the appliance to prepare food for the first time, you will need to put the turntable in place correctly. You must clean the cooking compartment and accessories. You can also refer them to the cleaning section.

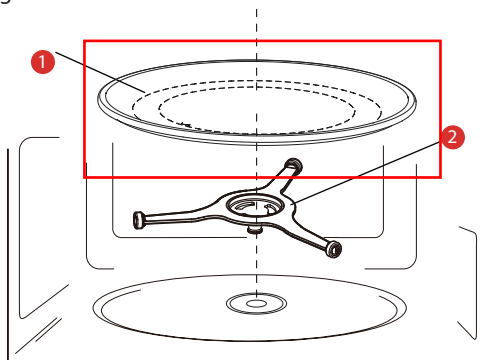

- 1) Glass Tray
- 2) Turntable Ring Assembly

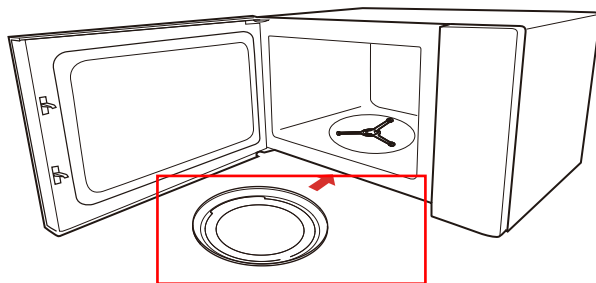

NOTE

- Never use the appliance without the turntable. Make sure that it is properly engaged. The turntable can turn clockwise or anti-clockwise.
- Never place the glass tray upside down. The glass tray should never be restricted.
- Both glass tray and turntable ring assembly must always be used during cooking.
- All food and containers of food are always placed on the glass tray for cooking.
- Never restrict the movement of the turntable.
- If glass tray or turntable ring assembly cracks or breaks, contact your nearest authorized service center.

SETTING UP YOUR OVEN

COUNTERTOP INSTALLATION

Remove all packing material and accessories. Examine the oven for any damage such as dents or broken door. Do not install if oven is damaged.

Cabinet: Remove any protective film found on the microwave oven cabinet surface. Do not remove the waveguide cover that is attached to the oven cavity to protect the magnetron.

INSTALLATION

1. Select a level surface that provide enough open space for the intake and/or outlet vents.
 - a. The minimum installation height is 85cm.
 - b. The rear surface of appliance shall be placed against a wall. Leave a minimum clearance of 30cm above the oven. A minimum clearance of 20cm is required between the oven and any adjacent walls.
 - c. Do not remove the legs from the bottom of the oven.
 - d. Blocking the intake and/or outlet openings can damage the oven.
 - e. Place the oven as far away from radios and TV as possible.
Operation of microwave oven may cause interference to your radio or TV reception.

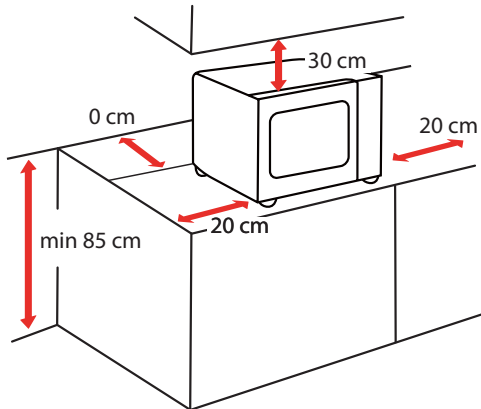

SETTING UP YOUR OVEN

2. Plug your oven into a standard household outlet. Be sure the voltage and the frequency is the same as the voltage and the frequency on the rating label.



WARNING

- Do not install oven over a range cooktop or other heat-producing appliance. If installed near or over a heat source, the oven could be damaged and the warranty would be void.

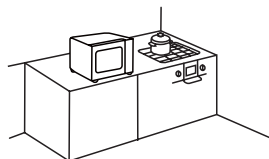

The accessible surface may be hot during operation.

INSTRUCTION FOR USE

BEFORE USING FOR THE FIRST TIME

The appliance may produce unpleasant odors when it is used for the first time.

This section tells you what you need to do before using your microwave to prepare food for the first time. Read the section entitled "**IMPORTANT SAFETY INSTRUCTIONS**" beforehand on page 3.

Before you can use your new appliance, you will need to put the turntable in place correctly. You must also clean the cooking compartment and accessories.



NOTE



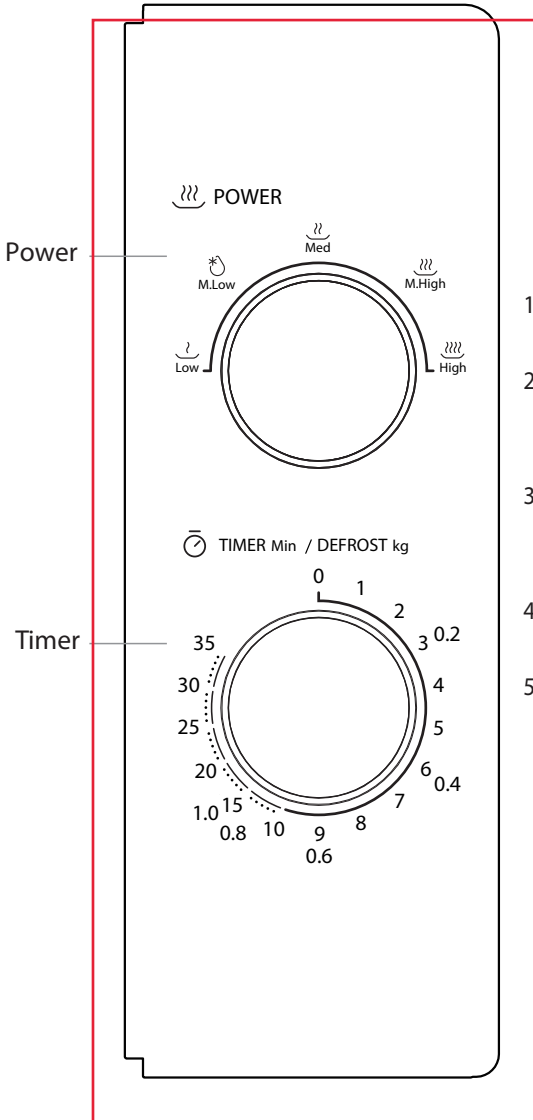

- Never use the appliance without the turntable.
- Make sure that it is properly engaged. The turntable can turn clockwise or anti-clockwise.

OPERATION

OPERATION INSTRUCTIONS



1. To set cooking power by turning the power knob to desired level.
2. To set the time of cooking by turning the timer knob to desired time per your food cooking guide.
3. The microwave oven will automatically start cooking after power level and time are set.
4. After the cooking time is up, the unit will "Dong" to stop.
5. If the unit is not in use, always set time to "0".

FUNCTION/POWER	OUTPUT	APPLICATION
LOW 	17% micro.	Soften ice cream
M. LOW 	33% micro.	Soup stew, soften butter or defrost
MED 	55% micro.	Stew, fish
M. HIGH 	77% micro.	Rice, fish, chicken, ground meat
HIGH 	100% micro.	Reheat, milk, boil water, vegetables, beverage



NOTICE:

- When removing food from the oven, please ensure that the oven power is switched off by turning the timer switch to 0 (zero). Failure to do so, and operating the microwave oven without food in it, can result in overheating and damage to the magnetron.

CLEANING

With good care and cleaning, your appliance will retain its appearance and remain fully functioning for a long time to come. We will explain here how you should correctly care for and clean your appliance.



WARNING

- Scratched glass in the appliance door may develop into a crack. Do not use a glass scraper, sharp or abrasive cleaning aids or detergents.
- The surface of the appliance may become damaged if it is not cleaned properly. Microwave energy may escape. Clean the appliance on a regular basis, and remove any food remnants immediately.
- Do not immerse the appliance in water or clean under a jet of water.

Cleaning agent

To ensure that the different surfaces are not damaged by using the wrong cleaning agent, observe the information below. Wash new sponge cloths thoroughly before use.

Do not use:



Harsh or abrasive cleaning agents



Metal or glass scrapers to clean the door panels



Metal or glass scrapers to clean the door seal



Hard scouring pads or sponges



Cleaning agents with a high alcohol content

APPLIANCE FRONT

Hot soapy water:

Clean using a dish cloth and then dry with a soft cloth. Do not use metal or glass scrapers for cleaning.

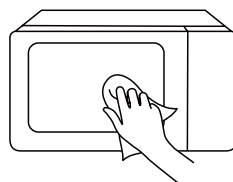

CLEANING

APPLIANCE FRONT PLATE

Hot soapy water:

Clean using a dish cloth and then dry with a soft cloth. Remove splashes and patches of limescale, grease, starch and albumin immediately. Corrosion can form under these patches or splashes. Do not use glass cleaners or metal or glass scrapers for cleaning.

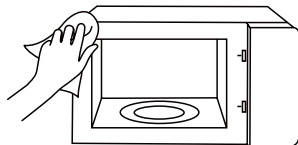

APPLIANCE CAVITY

Hot soapy water or vinegar solution:

Clean using a dish cloth and then dry with a soft cloth. Do not use oven spray or any other aggressive oven cleaners or abrasive materials. Scouring pads, rough sponges and pan cleaners are also unsuitable. These items scratch the surface. Allow the interior surfaces to dry completely.

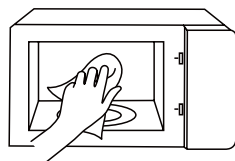

RECESS IN THE COOKING COMPARTMENT

Damp cloth:

Water must not be allowed to run into the appliance through the turntable drive. Dry the turntable drive with a cloth.

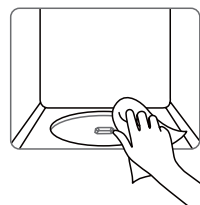

TURNTABLE AND ROLLER RING

Hot soapy water:

When placing the turntable back into its recess, it must engage properly.



DOOR PANEL

Glass cleaner:

Clean with a dish cloth. Do not use glass scrapers.

TROUBLESHOOTING

MAINTENANCE

Check your problem by using the chart below and try the solutions for each problem.
If the microwave oven still does not work properly, contact the nearest authorized service center.

TROUBLE	POSSIBLE CAUSE	POSSIBLE REMEDY
Oven will not start	<ul style="list-style-type: none"> a. Electrical cord for oven is not plugged in. b. Door is open. c. Wrong operation is set. 	<ul style="list-style-type: none"> a. Plug into the outlet. b. Close the door and try again. c. Check instructions
Arcing or sparking	<ul style="list-style-type: none"> a. Materials to be avoided in microwave oven were used. b. The oven is operated when empty. c. Spilled food remains in the cavity. 	<ul style="list-style-type: none"> a. Use microwave-safe cookware only. b. Do not operate with oven empty. c. Clean cavity with soft damp cloth.
Unevenly cooked foods	<ul style="list-style-type: none"> a. Materials to be avoided in microwave oven were used. b. Food is not defrosted completely. c. Cooking time, power level is not suitable. d. Food is not turned or stirred. 	<ul style="list-style-type: none"> a. Use microwave-safe cookware only. b. Completely defrost food. c. Use correct cooking time, power level. d. Turn or stir food.
Overcooked foods	Cooking time, power level is not suitable.	Use correct cooking time, power level.
Undercooked foods	<ul style="list-style-type: none"> a. Materials to be avoided in microwave oven were used. b. Food is not defrosted completely. c. Oven ventilation ports are restricted. d. Cooking time, power level is not suitable. 	<ul style="list-style-type: none"> a. Use microwave-safe cookware only. b. Completely defrost food. c. Check to see that oven ventilation ports are not restricted. d. Use correct cooking time, power level
Improper defrosting	<ul style="list-style-type: none"> a. Materials to be avoided in microwave oven were used. b. Cooking time, power level is not suitable. c. Food is not turned or stirred. 	<ul style="list-style-type: none"> a. Use microwave-safe cookware only. b. Use correct cooking time, power level. c. Turn or stir food.



According to Waste of Electrical and Electronic Equipment (WEEE) directive, WEEE should be separately collected and treated. If at any time in future you need to dispose of this product please do NOT dispose of this product with household waste. Please send this product to WEEE collecting points where available.

#DetailsMatter

FORNO A MICROONDE

MW-MM20P(BK)/MW-MM20P(WH)

Si prega di leggere il Manuale di istruzioni prima dell'utilizzo.

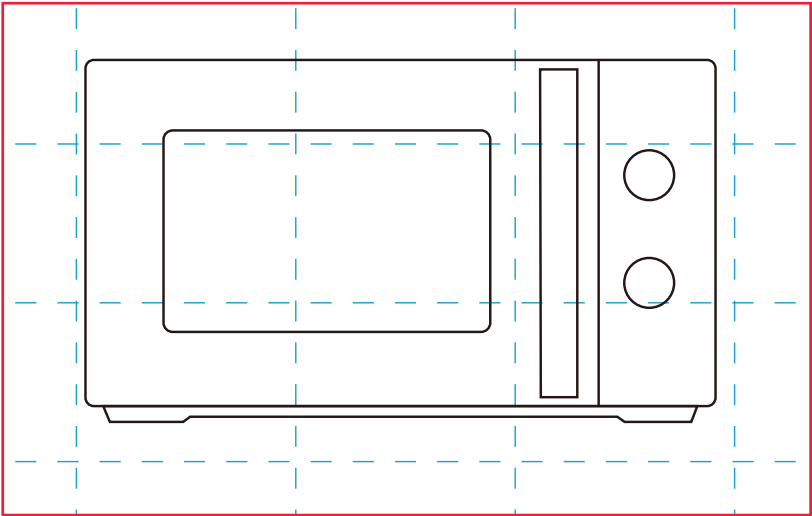

CONTENUTI

SICUREZZA DEI PRODOTTI

Precauzioni per evitare possibili esposizioni a un'eccessiva energia a microonde.....	IT-01
Importanti istruzioni per la sicurezza.....	IT-03
Ridurre il rischio di lesioni personali durante l'operazione di messa a terra.....	IT-07
Pulizia.....	IT-09
Utensili	IT-10
Materiali ammissibili nel forno a microonde.....	IT-11
Materiali non ammissibili nel forno a microonde.....	IT-13

IMPOSTAZIONE DEL PRODOTTO

Preparazione del forno.....	IT-14
-----------------------------	-------

ISTRUZIONI PER L'USO

Prima di utilizzare per la prima volta.....	IT-18
Operazione	IT-19
Pulizia.....	IT-21

MANUTENZIONE

Risoluzione dei problemi.....	IT-23
-------------------------------	-------



NOTA

PRIMA DI UTILIZZARE QUESTO PRODOTTO, SI PREGA DI LEGGERE, COMPRENDERE E SEGUIRE LE PRESENTI ISTRUZIONI. ASSICURARSI DI CONSERVARE IL PRESENTE MANUALE PER RIFERIMENTO FUTURO

SICUREZZA DEI PRODOTTI

PRECAUZIONI PER EVITARE POSSIBILI ESPOSIZIONI A UN'ECESSIVA ENERGIA A MICROONDE

(a). Non tentare di utilizzare questo forno a microonde con lo sportello aperto, poiché può comportare la perdita dell'energia delle microonde, che è dannosa alla salute. Evitare di rompere o manomettere gli interblocchi di sicurezza.

(b). Non posizionare alcun oggetto tra lo spazio anteriore del forno e la porta, ed evitare che le polveri o detersivi si accumulino sulle superfici delle guarnizioni.

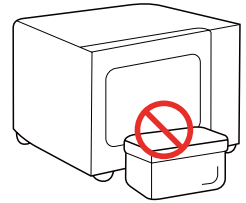

(c). **AVVERTENZA:** Se le guarnizioni della porta o la porta sono danneggiate, non è consentito usare il forno fino a quando non è stato riparato da un tecnico competente.

APPENDICE

Se l'apparecchio non viene mantenuto pulito, la sua superficie può essere danneggiata, ciò influisce sulla sua durata e può causare pericoli.

SPECIFICHE

MODELLO	MW-MM20P(BK)/MW-MM20P(WH)
TENSIONE NOMINALE/FREQUENZA	230-240V~ 50Hz
INGRESSO NOMINALE (MICROONDE)	1200-1270 W
POTENZA NOMINALE (MICROONDE)	750-800 W



NOTA

Tutte le immagini nel presente Manuale sono indicative e possono essere leggermente diverse dall'apparecchio acquistato, si prega di fare riferimento al prodotto reale.

IMPORTANTI ISTRUZIONI PER LA SICUREZZA



**AVVER-
TENZA**

Per ridurre il rischio di scosse elettriche, lesioni alle persone o esposizione a un'eccessiva energia a microonde durante l'utilizzo dell'apparecchio, seguire le precauzioni di base, tra cui:



Leggere e seguire:
**"PRECAUZIONI PER
EVITARE POSSIBILI
ESPOSIZIONI A
UN'ECESSIVA ENERGIA
A MICROONDE".**



Questo dispositivo può essere utilizzato da bambini di età pari o superiore a 8 anni e da persone con capacità fisiche, sensoriali o mentali ridotte o dalla mancanza di esperienza e conoscenza se siano sotto supervisione o istruzione sull'uso del dispositivo in modo sicuro e comprendono i pericoli coinvolti. I bambini non devono giocare con il dispositivo. La pulizia e la

manutenzione dell'utente non devono essere eseguite da bambini senza supervisione.



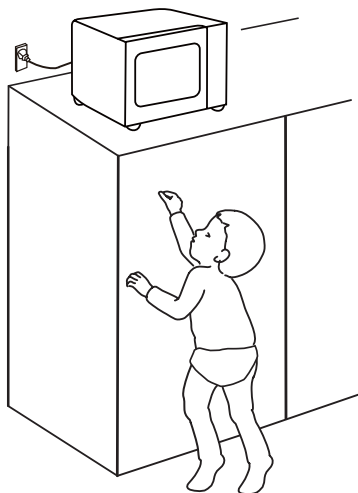

Tenere l'apparecchio e il suo cavo fuori dalla portata dei bambini di età inferiore a 8 anni.





IMPORTANTI ISTRUZIONI PER LA SICUREZZA

 Se il cavo di alimentazione è danneggiato, esso deve essere sostituito dal produttore, dal suo agente di servizio o da persone qualificate per evitare pericoli.

 **AVVERTENZA:** Assicurarsi che l'apparecchio sia spento prima di sostituire la lampada per evitare la possibilità di scosse elettriche.

 **AVVERTENZA:** È pericoloso per chiunque non sia un tecnico competente effettuare qualsiasi operazione di manutenzione o riparazione, che riguarda la rimozione di una copertura contro la perdita dell'energia a microonde.

 **AVVERTENZA:** I liquidi e gli altri alimenti non devono essere riscaldati in contenitori sigillati poiché rischiano di esplodere.

 Quando si riscalda il cibo in contenitori di plastica o carta, tenere d'occhio il forno per evitare possibile incendio.



 Utilizzare solo utensili adatti per forni a microonde.

 In caso di presenza di fumo, spegnere o scollegare l'apparecchio dall'alimentazione, e tenere lo sportello chiuso per prevenire pericoli.

 Il riscaldamento di bevande a microonde può causare un'ebollizione ritardata e schizzi di liquido bollente; pertanto, è necessario prestare attenzione quando si maneggia il contenitore.

 Il contenuto dei biberon e dei barattoli degli alimenti per l'infanzia deve essere agitato e mescolato, e la temperatura deve essere controllata prima del consumo, al fine di evitare ustioni.

IMPORTANTI ISTRUZIONI PER LA SICUREZZA

 È importante pulire regolarmente il forno ed eliminare eventuali residui di cibo. Vi ringraziamo per aver mantenuto in ordine l'area della guida d'onda. Se ci sono residui di cibo sull'area della guida d'onda o sulla cavità, pulirli con un panno morbido e umido. La mancata rimozione dei residui di cibo può provocare scintille innocue, una piccola quantità di fumo e/o lo scolorimento della cavità del microonde.

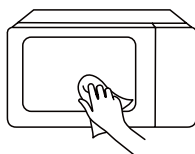

 Se il forno non viene mantenuto pulito può comportare il deterioramento della sua superficie, che a sua volta influisce

negativamente sulla vita dell'apparecchio e provocare eventualmente situazioni pericolose.

 Utilizzare solo la sonda di temperatura consigliata per questo forno. (per forni dotati di una sonda di rilevamento della temperatura per facilità d'uso.)

 Il forno a microonde deve essere azionato con la porta decorativa aperta. (applicabili per forni con porta decorativa.)

 Questo apparecchio è destinato ad essere utilizzato in applicazioni domestiche e simili come:

1. aree cucina del personale in negozi, uffici e altri ambienti di lavoro;
2. da clienti in hotel, motel e altri ambienti di tipo residenziale;
3. agriturismo;
4. locali bed and breakfast.

IMPORTANTI ISTRUZIONI PER LA SICUREZZA

 Il forno a microonde è destinato al riscaldamento di cibi e bevande. L'essiccazione di alimenti o indumenti e il riscaldamento di cuscini riscaldanti, pantofole, spugne, panni umidi e simili, possono comportare rischi di lesioni, accensione.

 L'apparecchio è destinato ad essere utilizzato indipendentemente.

 La superficie posteriore degli apparecchi deve essere appoggiata a una parete.

 Le uova con guscio e le uova sode non devono essere riscaldate nel forno a microonde, poiché potrebbero esplodere sia durante che dopo che il riscaldamento a microonde.

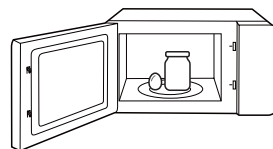

 L'apparecchio non deve essere installato dietro una porta decorativa per evitare il surriscaldamento. (Questa norma non è applicabile per gli elettrodomestici con porta decorativa.)

 Il forno a microonde non deve essere collocato in un mobile.

 I contenitori metallici per alimenti e bevande non possono essere posizionati all'interno del forno durante la cottura a microonde.

 L'apparecchio non può essere pulito con un pulitore a vapore.

 Gli elettrodomestici non sono destinati ad essere azionati tramite un timer esterno o un sistema di controllo remoto separato.

**LEGGERE ATTENTAMENTE E CONSERVARE
LE ISTRUZIONI PER RIFERIMENTO FUTURO**

RIDURRE IL RISCHIO DI LESIONI PERSONALI DURANTE L'OPERAZIONE DI MESSA A TERRA

Questo apparecchio deve essere messo a terra. In caso di cortocircuito elettrico, la messa a terra riduce il rischio di scosse elettriche, fornendo un filo di fuga per la corrente elettrica.

Questo apparecchio è dotato di un cavo con un filo di messa a terra con una spina di messa a terra. La spina deve essere collegata a una presa correttamente installata e messa a terra.

AVVERTENZA - L'impostazione impropria della messa a terra può comportare un rischio di scosse elettriche. Consultare un elettricista o un tecnico qualificato in caso di dubbio e incomprensioni delle istruzioni di messa a terra, oppure quando necessita l'assistenza per la messa a terra.

Se è necessario utilizzare una prolunga, utilizzare solo una prolunga a 3 fili.



PERICOLO

Rischio di scosse elettriche

Toccare alcuni dei componenti interni può causare gravi lesioni personali o morte. Non smontare questo apparecchio.

RIDURRE IL RISCHIO DI LESIONI PERSONALI DURANTE L'OPERAZIONE DI MESSA A TERRA



**AVVER-
TENZA**

Rischio di scosse elettriche

L'uso improprio della messa a terra può provocare scosse elettriche. Non collegare alla presa fino a quando l'apparecchio non è installato correttamente e messo a terra.

1. È stato fornito un cavo di alimentazione corto per ridurre i rischi derivanti dall'inciampo su un cavo più lungo.
2. Se si utilizza un cavo lungo o una prolunga:
 - (1). La potenza elettrica nominale contrassegnata del set di cavi o della prolunga deve essere almeno pari alla potenza elettrica dell'apparecchio.
 - (2). La prolunga deve essere un cavo a 3 fili di tipo di messa a terra.
 - (3). Il cavo lungo deve essere disposto in modo che non si drappeggia sul piano di lavoro o sul piano del tavolo, per evitare che i bambini lo tirino o inciampino su di esso.

PULIZIA

Assicurarsi di scollegare l'apparecchio dall'alimentazione.

1. Pulire la cavità del forno dopo l'uso con un panno leggermente umido.
2. Pulire gli accessori nella stessa maniera con acqua saponata.
3. Il telaio e la guarnizione dello sportello e le parti verniciate devono essere puliti accuratamente con un panno umido.
4. Non utilizzare detergenti abrasivi aggressivi o raschietti metallici taglienti per pulire il vetro della porta del forno, poiché possono graffiare la superficie, provocando la rottura del vetro.
5. Suggerimento per la pulizia: Per facilitare la pulizia delle pareti della cavità con cui il cibo cotto può entrare in contatto: Mettere il liquido di mezzo limone in una ciotola, aggiungere 300 ml (1/2 pinta) di acqua e riscaldare al 100% a microonde per 10 minuti. Pulire il forno con un panno morbido e asciutto.

UTENSILI



CAUTELA

Pericolo di lesioni personali:

È pericoloso per chiunque non sia un tecnico competente effettuare qualsiasi operazione di manutenzione o riparazione, che riguarda la rimozione di una copertura contro la perdita dell'energia a microonde. Vedi le istruzioni su

"Materiali ammissibili nel forno a microonde" o "Materiali non ammissibili nel forno a microonde"

Potrebbero esserci alcuni utensili non metallici che non sono sicuri da usare per il microonde. In caso di dubbio, è possibile testare l'utensile in questione seguendo la procedura riportata di seguito.

Test dell'utensile:

1. Riempire un contenitore adatto per essere usato nel microonde con 1 tazza di acqua fredda (250 ml), mettendo all'interno del contenitore insieme l'utensile in questione.
2. Cottura alla massima potenza per 1 min.
3. Controllare attentamente l'utensile. Se l'utensile vuoto è caldo, non usarlo per cucinare a microonde.
4. Non superare il tempo di cottura di 1 minuto.

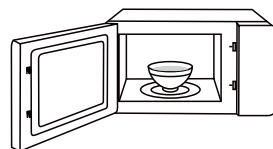





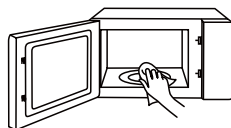











NOTA

MANTENERE PULITA LA CAVITÀ
E L'AREA DELLA GUIDA
DELL'ONDA



MATERIALI AMMISSIBILI NEL FORNO A MICROONDE

UTENSILI	OSSERVAZIONI	
 Piatto di doratura	Seguire le istruzioni del produttore. Il fondo del piatto di doratura deve essere posizionato almeno 3/16 pollice (5 mm) dal piatto girevole. L'utilizzo scorretto può causare la rottura del piatto girevole.	
 Stoviglie	Solo i tipi adatti per microonde. Seguire le istruzioni del produttore. Non usare piatti con spaccatura o scheggiati.	
 Barattoli di vetro	Rimuovere sempre il coperchio. Utilizzarlo solo per riscaldare il cibo fino a quando non è appena caldo. La maggior parte dei barattoli di vetro non sono resistenti al calore e possono rompersi.	
 Vetreteria	Solo vetreria da forno resistente al calore. Assicurarsi che non ci siano finiture metalliche. Non usare piatti con spaccatura o scheggiati.	
 Sacchetti per la cottura del forno	Seguire le istruzioni del produttore. Non chiudere il sacchetto con una molletta metallica. Lasciare un po' aperto il sacchetto per la fuoriuscita dei vapori.	
 Piatti e bicchieri di carta	Utilizzarli solo per cucinare / riscaldare per breve tempo. Non lasciare il forno incustodito durante la cottura.	
 Asciugamani di carta	Utilizzarlo per coprire il cibo, permettendo di riscaldare e assorbire il grasso. Durante l'utilizzo, controllare sempre il forno e lo si utilizza solo per una cottura a breve termine.	
 Carta pergamena	Utilizzarla come copertura per evitare schizzi o come una guarnizione per la cottura a vapore.	

MATERIALI AMMISSIBILI NEL FORNO A MICROONDE

UTENSILI

OSSERVAZIONI



Plastico

Solo i tipi adatti per microonde. Seguire le istruzioni del produttore. Deve essere etichettato con "Adatto al microonde". Alcuni contenitori di plastica si ammorbidiscono, poiché il cibo all'interno si scalda. I "sacchetti bollenti" e i sacchetti di plastica ben chiusi devono essere lasciati leggermente aperti, forati o ventilati come indicato dalla confezione.



Pellicola trasparente

Solo i tipi adatti per microonde. Utilizzarla per coprire il cibo durante la cottura per trattenere l'umidità. Non lasciare che l'involucro di plastica tocchi il cibo.

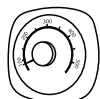

Termometri

Solo per microonde (termometri per carne e caramelle).











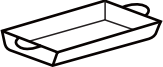





Carta fa forno

Utilizzarlo come copertura per evitare schizzi e trattenere l'umidità.



MATERIALI NON AMMISSIBILI NEL FORNO A MICROONDE

UTENSILI	OSSERVAZIONI
 <p>Vassoio in alluminio</p>	Può causare l'arco. Spostare il cibo in un piatto sicuro per il microonde. 
 <p>Cartone alimentare con manico in metallo</p>	Può causare l'arco. Spostare il cibo in un piatto sicuro per il microonde. 
 <p>Utensili metallici o rifiniti in metallo</p>	Il metallo protegge il cibo dall'energia delle microonde. Il rivestimento metallico può causare l'arco. 
 <p>Fascette a torsione in metallo</p>	Può causare archi e incendio nel forno. 
 <p>Busti di carta</p>	Può causare un incendio nel forno. 
 <p>Schiuma plastica</p>	La schiuma plastica può sciogliere o contaminare il liquido all'interno del contenitore se esposta ad alte temperature. 
 <p>Legno</p>	La legna si asciugherà se utilizzata nel forno a microonde e potrebbe dividersi o rompersi. 

IMPOSTAZIONE DEL PRODOTTO

PREPARAZIONE DEL FORNO

NOMI DELLE PARTI E DEGLI ACCESSORI DEL FORNO A MICROONDE

Rimuovere il forno e tutti i materiali dalla cavità del forno e dal cartone.

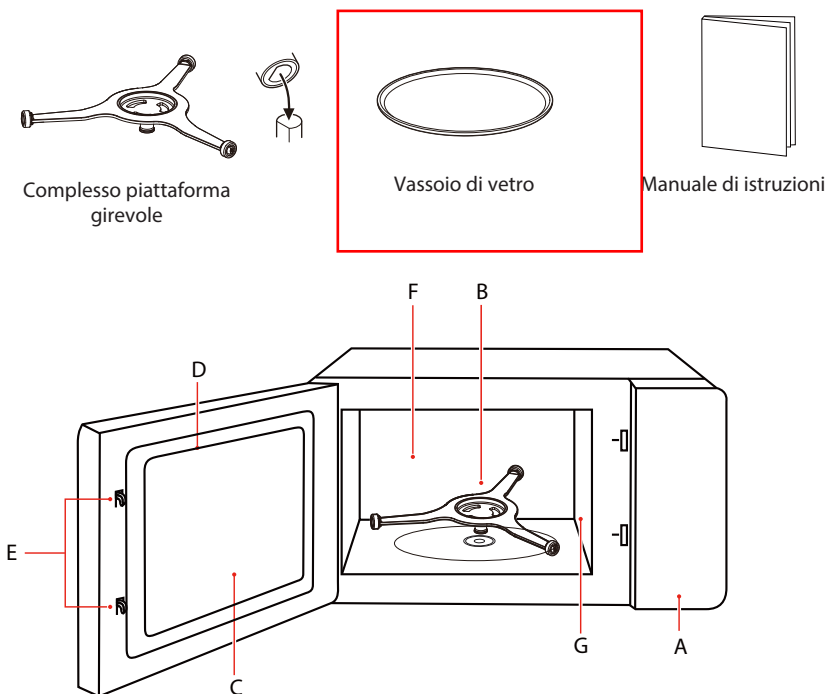

PREPARAZIONE DEL FORNO

INSTALLAZIONE DEL GIRADISCHI

Pulizia del vano di cottura e posizionamento della piastra girevole

Per la prima installazione, assicurarsi che tutto l'imballaggio e il nastro da imballaggio siano stati rimossi dall'albero della piastra girevole.

Prima del primo utilizzo dell'apparecchio per la preparazione del cibo, si prega di installare la piastra girevole in maniera corretta. Si deve pulire il vano di cottura e gli accessori.

Come mettere la piastra girevole in posizione:

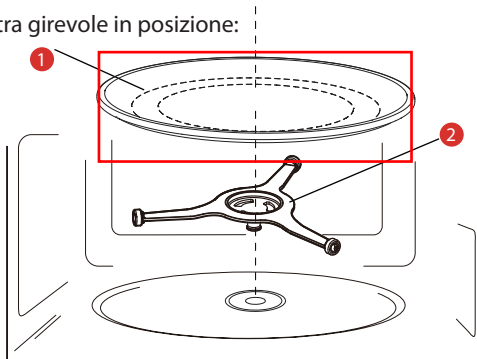

1.Vassoio di vetro
2.Complesso piattaforma girevole

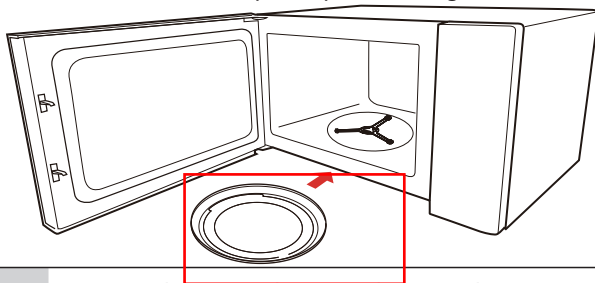

CAUTELA

- Non utilizzare mai l'apparecchio senza la piastra girevole. Assicurarsi che sia correttamente inserita. La piastra girevole può girare in senso orario o antiorario.
- Non capovolgere mai il vassoio di vetro. Il movimento del vassoio in vetro non deve mai essere limitato.
- Durante la cottura devono essere sempre utilizzati sia il vassoio in vetro che il gruppo dell'anello della piastra girevole.
- Tutti gli alimenti e i loro contenitori devono sempre posizionati sul vassoio in vetro per la cottura.
- Non limitare mai il movimento della piastra girevole.
- Se il vassoio di vetro o il gruppo dell'anello della piastra girevole si incrina o si rompe, contattare il centro di assistenza autorizzato più vicino.

PREPARAZIONE DEL FORNO

INSTALLAZIONE SUL PIANO DI LAVORO

Rimuovere tutto il materiale di imballaggio e gli accessori. Esaminare il forno per eventuali danni come ammaccature o sportello rotto. Non installare se il forno a microonde è danneggiato.

Parte interna: Rimuovere tutte le pellicole protettive presenti sulle superci della parte interna del forno a microonde.

Non rimuovere il sottile rivestimento marrone guida d'onda attaccato alla cavità del forno per proteggere il magnetron.

INSTALLAZIONE

1. Selezionare una superficie piana che può offrire uno spazio sufficiente per gli sfati di aspirazione e/o uscita.
 - a. L'altezza minima di installazione è di 85 cm.
 - b. La superficie posteriore degli apparecchi deve essere appoggiata a una parete. Lasciare uno spazio minimo di 30 cm sopra il forno. È necessaria una distanza minima di 20cm tra il forno e le pareti adiacenti.
 - c. Non rimuovere le gambe dal fondo del forno.
 - d. L'ostruzione degli sfati di aspirazione e/o uscita può danneggiare il forno.
 - e. Posizionare il forno il più lontano possibile da radio e TV.
Il funzionamento del forno a microonde può causare interferenze alla ricezione radiofonica o televisiva.

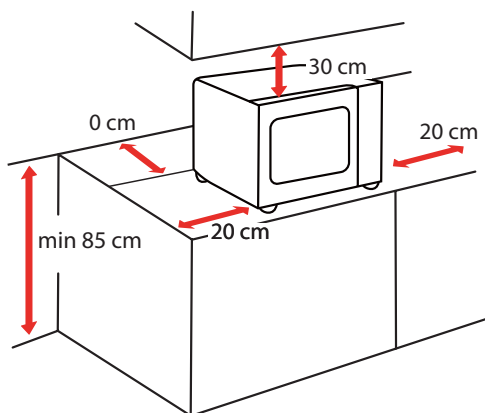

PREPARAZIONE DEL FORNO

2. Collegare il forno a una presa domestica standard. Assicurarsi che la tensione e la frequenza siano uguali a quelle indicate sull'etichetta di classificazione energetica.



AVVERTENZA

- Non installare il forno su un piano cottura o altri apparecchi che producono calore.

Se installato vicino o sopra una fonte di calore, il forno potrebbe danneggiarsi e la garanzia verrebbe annullata.

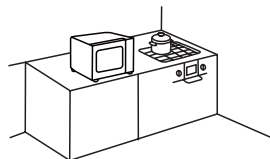

La superficie accessibile
può essere calda durante il
funzionamento.

ISTRUZIONI PER L'USO

PRIMA DI UTILIZZARE PER LA PRIMA VOLTA

L'apparecchio può produrre odori sgradevoli al primo utilizzo.

Questa sezione fornisce le istruzioni da seguire prima del primo utilizzo del microonde per preparare il cibo. Leggere prima la sezione intitolata **"ISTRUZIONI IMPORTANTI PER LA SICUREZZA"** a pagina 3.

Prima di utilizzare il nuovo apparecchio, si prega di posizionare correttamente la piastra girevole. È inoltre necessario pulire il vano di cottura e gli accessori.



NOTA



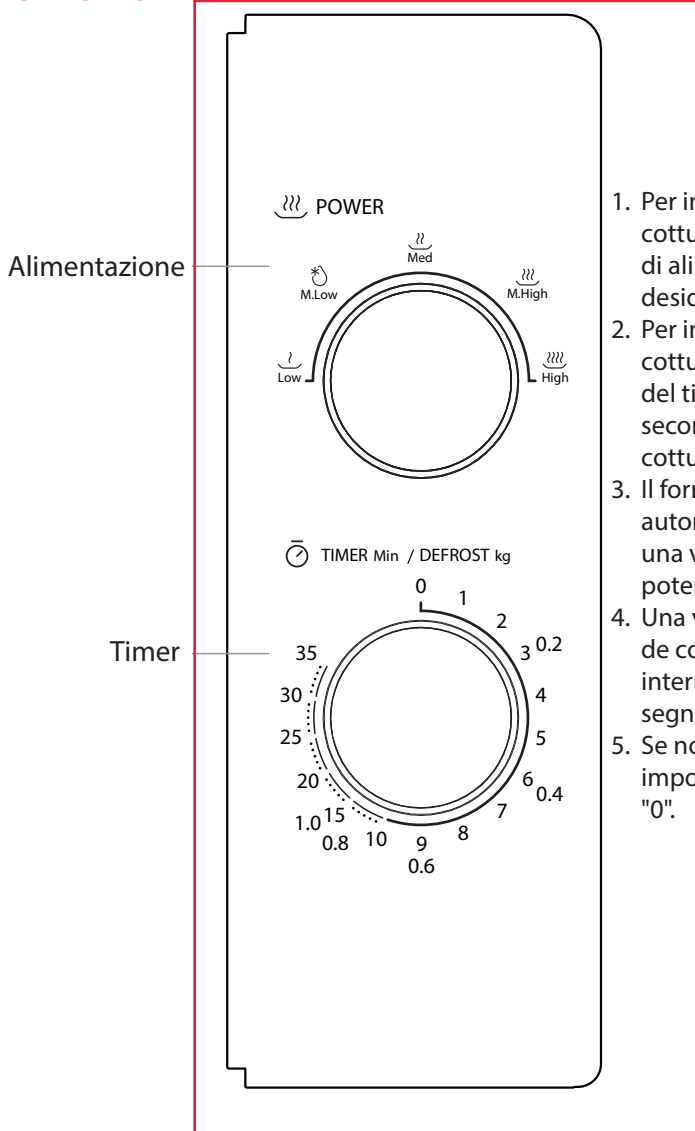

- Non utilizzare mai l'apparecchio senza la piastra girevole.
- Assicurarsi che sia correttamente inserita. La piastra girevole può girare in senso orario o antiorario.

OPERAZIONE

ISTRUZIONI PER L'USO



1. Per impostare la potenza di cottura ruotare la manopola di alimentazione al livello desiderato.
2. Per impostare l'ora di cottura ruotare la manopola del timer sull'ora desiderata secondo la Guida della cottura degli alimenti.
3. Il forno a microonde inizierà automaticamente la cottura una volta settati il livello di potenza e l'ora.
4. Una volta trascorso il tempo di cottura, l'apparecchio si interrompe emettendo un segnale acustico "Dong".
5. Se non si usa l'apparecchio, impostare sempre il timer su "0".

FUNZIONE/POTENZA	USCITA	APPLICAZIONE
BASSO	 17% Micro.	Ammorbidire il gelato
MEDIO-BASSO	 33% Micro.	Stufare la zuppa, scogliere il burro o scongelare
MEDIO	 55% Micro.	Stufato, pesce
MEDIO-ALTO	 77% Micro.	Riso, pesce, pollo, carne macinata
ALTO	 100% Micro.	Riscaldare, latte, acqua bollente, verdure, bevande



NOTA

- Quando si rimuove il cibo dal forno, assicurarsi che l'alimentazione del forno sia spenta ruotando la manopola del timer su 0 (zero). In caso contrario, l'accensione del forno a microonde senza cibo al suo interno, può causare surriscaldamento e danni al magnetron.

PULIZIA

Con cura e pulizia adeguata, il tuo apparecchio manterrà il suo aspetto estetico e rimarrà perfettamente funzionante per lungo periodo di tempo. Spiegheremo qui come curare e pulire correttamente il tuo apparecchio.



AVVERTENZA

- Il graffio del vetro dello sportello dell'apparecchio può trasformarsi in una crepa. Non utilizzare raschietti per vetro, strumenti taglienti o abrasivi per la pulizia o detersivi.
- La superficie dell'apparecchio può danneggiarsi se non viene pulita adeguatamente. L'energia del microonde potrebbe fuoriuscire. Pulire regolarmente l'apparecchio e rimuovere immediatamente eventuali residui di cibo.
- Non immergere l'apparecchio in acqua né pulirlo sotto il flusso d'acqua.

Detergente di pulizia

Per garantire che le varie superfici dell'apparecchio non vengano danneggiate dall'utilizzo di un detergente sbagliato, rispettare le indicazioni seguenti. Lavare accuratamente i panni e spugne nuovi prima dell'uso.

Non utilizzare:



Detergenti aggressivi o abrasivi



Raschietti per metallo o vetro per la pulizia dei pannelli dello sportello



Raschietti per metallo o vetro per la pulizia della guarnizione dello sportello



Detergenti ad alto contenuto di alcol



Detergenti ad alto contenuto di alcol

PARTE ANTERIORE DELL'APPARECCHIO

Acqua saponata calda:

Pulire con un panno lavapiatti e quindi asciugare con un panno morbido.

Non utilizzare raschietti per metallo o vetro per la pulizia.

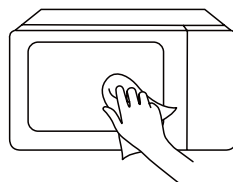

PULIZIA

PIASTRA FRONTALE DELL'APPARECCHIO

Acqua calda saponata:

Pulire con un canovaccio e poi asciugare con un panno morbido. Rimuovere immediatamente schizzi e macchie di calcare, grasso, amido e albumina. Queste macchie o schizzi possono dare origine alla corrosione del materiale. Non utilizzare detergenti per vetri o raschietti per metallo o vetro per la pulizia.

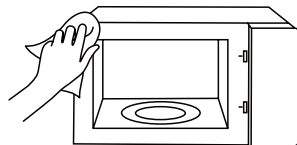

CAVITÀ DELL'APPARECCHIO

Acqua calda saponata o soluzione di aceto:

Pulire con un canovaccio e poi asciugare con un panno morbido. Non utilizzare spray detergente per forni o altri detergenti per forni che sono aggressivi o che sono fatti con materiali abrasivi. Inoltre, nemmeno le pagliette abrasive, spugne ruvide e detergenti per pentole sono adatte. Poiché questi prodotti possono graffiare la superficie. Lasciare asciugare completamente le superfici interne.

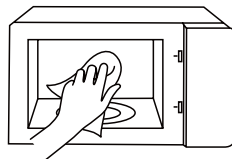

NICCHIA NEL VANO COTTURA

Panno bagnato:

L'acqua non può entrare nell'apparecchio attraverso la piastra girevole. Asciugare la piastra girevole con un panno.

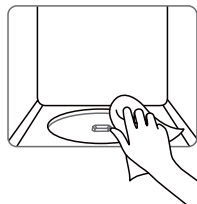

PIASTRA GIREVOLE E ANELLO ROTONDO

Acqua calda saponata:

Quando si ripone la piastra girevole nella sua nicchia, la piastra girevole deve essere inserita correttamente.

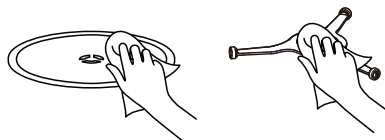

PANNELLO DELLO SPORTELLO

Detergente del vetro:

Pulire con un canovaccio. Non utilizzare raschietti per vetro.

RISOLUZIONE DEI PROBLEMI

Provare le soluzioni per ogni problema dopo aver utilizzato la tabella sottostante per verificare il problema. Se il forno a microonde continua a non funzionare correttamente, rivolgersi al servizio di assistenza autorizzato più vicino.

TROPPO	PROBABILE CAUSA	POSSIBILE SOLUZIONE
Il forno non si avvia	<ul style="list-style-type: none"> a. Il cavo elettrico del forno non è inserito. b. Lo sportello è aperto. c. È stato selezionato il funzionamento non corretto. 	<ul style="list-style-type: none"> a. Collegare alla presa di corrente. b. Chiudere lo sportello e riprovare. c. Verificare le indicazioni.
Arco elettrico o scintilla	<ul style="list-style-type: none"> a. Sono stati utilizzati articoli che non dovrebbero essere utilizzati in un forno a microonde. b. Il forno viene utilizzato quando è vuoto. c. Il cibo che si è rovesciato rimane nella cavità. 	<ul style="list-style-type: none"> a. Utilizzare solo pentole adatte al microonde. b. Non utilizzare mai un forno vuoto. c. Pulire la cavità con un panno umido.
Cibi cotti in modo non uniforme	<ul style="list-style-type: none"> a. Sono stati utilizzati articoli che non dovrebbero essere utilizzati in un forno a microonde. b. Il cibo non si è completamente scongelato. c. Il livello di potenza è insufficiente per il tempo di cottura. d. La pietanza non è stata girata o mescolata. 	<ul style="list-style-type: none"> a. Usare solo pentole adatte al microonde. b. Scongelare completamente gli alimenti. c. Utilizzare la potenza e il tempo di cottura adeguati. d. Mescolare o girare gli alimenti.
Cibi troppo cotti	Il tempo di cottura e il livello di potenza sono insufficienti.	Utilizzare la potenza e il tempo di cottura adeguati.
Alimenti poco cotti	<ul style="list-style-type: none"> a. Sono stati utilizzati articoli che non dovrebbero essere utilizzati in un forno a microonde. b. Il cibo non si è completamente scongelato. c. Le porte di ventilazione del forno sono limitate. d. Il tempo di cottura e il livello di potenza sono inadeguati. 	<ul style="list-style-type: none"> a. Utilizzare solo pentole adatte al microonde. b. Scongelare completamente gli alimenti. c. Verificare che le aperture di ventilazione del forno non siano ostruite. d. Utilizzare il tempo di cottura e il livello di potenza adeguati.
Scongelamento non corretto	<ul style="list-style-type: none"> a. Sono stati utilizzati articoli che non dovrebbero essere utilizzati in un forno a microonde. b. Livello di potenza e tempo di cottura inadeguati. c. Non sono stati girati o strofinati gli alimenti. 	<ul style="list-style-type: none"> a. Utilizzare solo pentole adatte al microonde. b. utilizzare il tempo di cottura e il livello di potenza consigliati. c. Scartare o girare il cibo.



Secondo la direttiva sui rifiuti di apparecchiature elettriche ed elettroniche (RAEE), i RAEE devono essere raccolti e smaltiti separatamente. Se in futuro si dovesse smaltire questo prodotto, si prega di non smaltirlo insieme ai rifiuti domestici. Portare il prodotto in un punto di raccolta RAEE, se disponibile.

#DetailsMatter

MANUAL DE INSTRUCCIONES

HORNO MICROONDAS

MW-MM20P(BK)/MW-MM20P(WH)

Por favor revise este manual de instrucciones antes de operar.

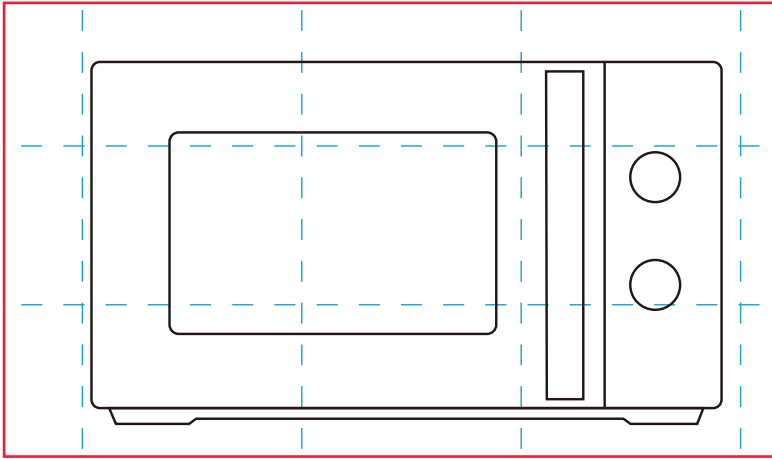

CONTENIDOS

SEGURIDAD DEL PRODUCTO

Precauciones para evitar posible exposición a energía excesiva de microondas.....	ES-01
Instrucciones importantes de seguridad.....	ES-03
Para reducir el riesgo de lesiones a las personas para instalación de puesta a tierra.....	ES-07
Limpieza	ES-09
Utensilios.....	ES-10
Materiales que se pueden usar en el horno de microondas	ES-11
Materiales que no se pueden usar en el horno de microondas.....	ES-13

CONFIGURACIÓN DEL PRODUCTO

Configuración del horno	ES-14
-------------------------------	-------

INSTRUCCIONES PARA USO

Antes del uso por primera vez.....	ES-18
Operación.....	ES-19
Limpieza	ES-21

MANTENIMIENTO

Resolución de problemas.....	ES-23
------------------------------	-------



NOTA

ANTES DE OPERAR ESTE PRODUCTO, LEA, COMPRENDA Y SIGA ESTAS INSTRUCCIONES. ASEGÚRESE DE GUARDAR ESTA LISTA PARA FUTURAS CONSULTAS

SEGURIDAD DEL PRODUCTO

PRECAUCIONES PARA EVITAR POSIBLE EXPOSICIÓN A ENERGÍA EXCESIVA DE MICROONDAS

(a). No intente operar el horno de microondas con la puerta abierta, o que resultará en una exposición perjudicial a la energía de microondas. Es importante no romper ni alterar los enclavamientos de seguridad.

(b). No coloque ningún objeto entre la cara frontal del horno y la puerta ni permita que se acumule suciedad o residuos de limpiador en las superficies de sellado.

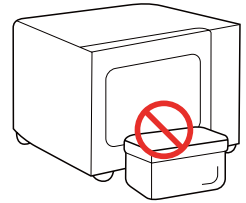

(c). **ADVERTENCIA:** Si la puerta o las juntas de la puerta están dañadas, el horno no debe utilizarse hasta que haya sido reparado por una persona competente.

APÉNDICE

Si el aparato no se mantiene en buen estado de limpieza, su superficie podría degradarse y afectar la vida útil del aparato y conducir a una situación peligrosa.

ESPECIFICACIONES

MODELO	MW-MM20P(BK)/MW-MM20P(WH)
TENSIÓN NOMINAL/FRECUENCIA	230-240V~ 50Hz
ENTRADA NOMINAL (MICROONDAS)	1200-1270 W
POTENCIA NOMINAL (MICROONDAS)	750-800 W



NOTA

Todas las imágenes de este manual tienen únicamente fines ilustrativos. Estas pueden ser ligeramente diferentes del equipo comprado, consulte el producto real.

INSTRUCCIONES IMPORTANTES DE SEGURIDAD



ADVERTENCIA

Para reducir el riesgo de incendio, descarga eléctrica, lesiones personales o exposición a la energía excesiva del horno de microondas al usar su aparato, lea y siga las precauciones básicas, incluidas las siguientes:



Lea y siga las específicas: **"PRECAUCIONES PARA EVITAR POSIBLE EXPOSICIÓN A ENERGÍA EXCESIVA DE MICROONDAS"**.



Este aparato puede ser utilizado por niños de 8 años o más y personas con capacidad física, sensorial o mental, o con falta de experiencia y conocimiento, si han recibido supervisión o instrucciones sobre el uso del aparato de manera segura y entienden los peligros existentes. Los niños no pueden jugar con el aparato. La limpieza y el

mantenimiento a realizar por el usuario no deben realizarlo los niños sin supervisión.



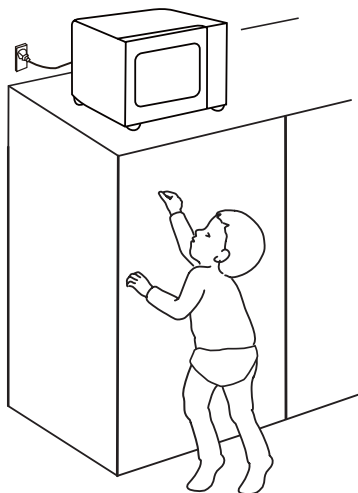

Mantenga el aparato y su cable fuera del alcance de los niños menores de 8 años.





INSTRUCCIONES IMPORTANTES DE SEGURIDAD

 Si el cable de alimentación está dañado, debe ser sustituido por el fabricante, su agente de servicio o personas cualificadas de forma similar, para evitar que se produzcan peligros.

 **ADVERTENCIA:** Asegúrese de que el aparato esté apagado antes de reemplazar la lámpara para evitar la posibilidad de descarga eléctrica.

 **ADVERTENCIA:** Es peligroso para cualquier persona no competente realizar cualquier servicio u operación de reparación relacionada con la retirada de una cubierta que brinda protección contra la exposición a la energía de microondas.

 **ADVERTENCIA:** Los líquidos y otros alimentos no deben calentarse en recipientes sellados, o pueden causar explosión.

 Al calentar alimentos en recipientes de plástico o papel, preste atención al horno para evitar posible ignición.



 Utilice únicamente utensilios adecuados para su uso en hornos de microondas.

 Si sale humo, apague o desconecte el aparato y mantenga la puerta cerrada para sofocar las llamas.

 El calentamiento de bebidas con el horno de microondas puede causar una ebullición eruptiva retardada, entonces es necesario tener cuidado al manipular el recipiente.

 Deben agitar el contenido de los biberones y los frascos de comida para bebés, y verificar la temperatura antes de consumirlos para evitar quemaduras.

INSTRUCCIONES IMPORTANTES DE SEGURIDAD

 El horno debe limpiarse periódicamente y eliminarse los restos de comida. Mantenga limpia el área de la guía de ondas. Utilice un paño suave y húmedo para limpiarlo cuando haya restos de comida en el área de la guía de ondas o en la cavidad. Si no limpie los restos de comida, pueden producirse chispas inocuas o algo de humo en la cavidad del microondas; también puede producirse una decoloración de la cavidad.

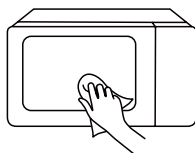

 No mantener el horno de microondas en condiciones limpias puede causar el deterioro de la superficie que podría afectar negativamente

la vida útil del aparato y posiblemente resultar en una situación peligrosa.

 Utilice solo la sonda de temperatura recomendada para este horno. (para hornos provistos de la posibilidad de utilizar una sonda con sensor de temperatura.)

 El horno de microondas debe funcionar con la puerta decorativa abierta. (para hornos con puerta decorativa).

 Este aparato está dirigido para uso doméstico y aplicaciones similares tales como:

1. áreas de cocina para el personal en tiendas, oficinas y otros entornos de trabajo;
2. por clientes en hoteles, moteles y otros entornos de tipo residencial;
3. casa rústica;
4. entornos tipo alojamiento y desayuno.

INSTRUCCIONES IMPORTANTES DE SEGURIDAD

 El horno de microondas está diseñado para calentar alimentos y bebidas. El secado de alimentos o ropa y el calentamiento de almohadillas térmicas, pantuflas, esponjas, paños húmedos y similares pueden provocar riesgo de lesiones, ignición o incendio.

 El aparato está diseñado para ser utilizado de forma independiente.

 La superficie trasera del aparato se colocará contra la pared.

 Los huevos con cáscara y los huevos duros no deben calentarse en el horno de microondas, ya que pueden explotar, incluso después del calentamiento por el horno de microondas.

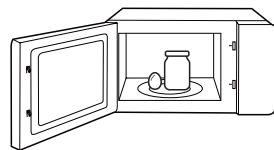

 El aparato no debe instalarse detrás de una puerta decorativa para evitar el sobrecalentamiento. (No se aplica para aparatos con puerta decorativa).

 No se debe colocar el horno microondas en un gabinete .

 No se permite el uso de recipientes metálicos para alimentos y bebidas en el horno de microondas.

 El aparato no debe limpiarse con un limpiador a vapor.

 No se prevé que el aparato sea operado mediante un temporizador externo o un sistema de control remoto separado.

LEA DETENIDAMENTE Y GUARDE PARA
FUTURAS REFERENCIAS

PARA REDUCIR EL RIESGO DE LESIONES A LAS PERSONAS PARA INSTALACIÓN DE PUESTA A TIERRA

Este aparato debe estar conectado a tierra. En caso de un cortocircuito eléctrico, la conexión a tierra reduce el riesgo de descarga eléctrica al proporcionar un cable de escape para la corriente eléctrica.

Este aparato está provisto de un cable que tiene un cable de conexión a tierra con un enchufe a tierra. El enchufe debe estar conectado a un tomacorriente que esté correctamente instalado y conectado a tierra.

ADVERTENCIA - El uso inadecuado de la conexión a tierra puede resultar en un riesgo de descarga eléctrica. Consulte a un electricista o técnico calificado cuando no entiende completamente las instrucciones de conexión a tierra o cuando existen dudas sobre si el aparato está conectado a tierra correctamente.

Use solo un cable de extensión de 3 hilos si es necesario.



PELIGRO

Peligro de Descarga Eléctrica:

Tocar algunos de los componentes internos puede causar lesiones personales graves o la muerte. No desmonte el aparato.

PARA REDUCIR EL RIESGO DE LESIONES A LAS PERSONAS PARA INSTALACIÓN DE PUESTA A TIERRA



ADVERTENCIA

Peligro de Descarga Eléctrica:

El uso inadecuado de la conexión a tierra puede provocar una descarga eléctrica. No lo enchufe en un tomacorriente hasta que el aparato esté correctamente instalado y conectado a tierra.

1. Se proporciona un cable corto de fuente de alimentación para reducir los riesgos de enredarse o tropezarse con un cable más largo.
2. Si se usa un cable largo o un cable de extensión:
 - (1).La clasificación eléctrica marcada del juego de cables o del cable de extensión debe ser al menos tan buena como la clasificación eléctrica del aparato.
 - (2).El cable de extensión debe ser un cable de 3 hilos a tierra.
 - (3).El cable más largo debe colocarse de manera que no caiga sobre la encimera o la mesa, donde los niños puedan tirar de él o tropezar.

LIMPIEZA

Asegúrese de desenchufar el aparato de la fuente de alimentación.

1. Limpie la cavidad del horno con un paño poco húmedo después del uso.
2. Limpie los accesorios con agua y jabón de la forma habitual.
3. Deben limpiar el marco de la puerta y las juntas y las partes cercanas cuidadosamente con un paño húmedo cuando estén sucios.
4. No utilice limpiadores abrasivos fuertes o raspadores metálicos afilados para limpiar el vidrio de la puerta del horno, ya que pueden dañar la superficie, lo que puede provocar la rotura del vidrio.
5. Consejo de limpieza --- Para limpiar fácilmente las paredes de la cavidad que los alimentos cocinados pueden tocar: Coloque medio limón en un tazón, agregue 300 ml (1/2 pinta) de agua y caliente al 100% el microondas durante 10 minutos. Limpie el horno con un paño suave y seco.

UTENSILLOS



PRECAUCIÓN

Riesgo de Lesiones Personales:

Es peligroso para cualquier persona no competente realizar cualquier servicio u operación de reparación relacionada con la retirada de una cubierta que brinda protección contra la exposición a la energía de microondas.

Consulte las instrucciones en **"Materiales que se pueden usar en el horno de microondas"** o **"Materiales que no se pueden usar en el horno de microondas"**.

Puede haber ciertos utensilios no metálicos que no sean seguros para usar en el microondas.

En caso de duda, puede probar el utensilio en cuestión siguiendo el procedimiento a continuación.

Prueba de Utensilios:

1. Llene un recipiente apto para microondas con 1 taza de agua fría (250 ml) junto con el utensilio en cuestión.
2. Cocine a máxima potencia durante 1 minuto.
3. Sienta con cuidado el utensilio. Si el utensilio vacío está caliente, no lo use para cocinar en el microondas.
4. No exceda el tiempo de cocción de 1 minuto.

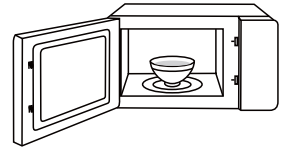





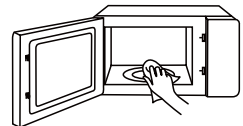







NOTA









MANTENGA LIMPIO EL ÁREA DE LAGUÍA DE CAVIDAD Y ONDAS

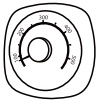

MATERIALES QUE SE PUEDEN USAR EN EL HORNO DE MICROONDAS

UTENSILLOS	OBSERVACIONES	
 Plato para dorar	Siga las instrucciones del fabricante. El fondo del plato para dorar debe estar al menos 3/16 pulgadas (5 mm) por encima del plato giratorio. El uso incorrecto puede hacer que se rompa el plato giratorio.	
 Vajilla	Solo apto para microondas. Siga las instrucciones del fabricante. No utilice platos rotos o astillados.	
 Jarras de vidrio	Retire siempre la tapa. Úselo solo para calentar alimentos hasta que estén calientes. La mayoría de los frascos de vidrio no son resistentes al calor y pueden romperse.	
 Cristalería	Solo cristalería para horno resistente al calor. Asegúrese de que no haya molduras metálicas. No utilice platos rotos o astillados.	
 Bolsas para cocinar al horno	Siga las instrucciones del fabricante. No cierre con amarre de metal. Haga ranuras para permitir que salga el vapor.	
 Platos y vasos de papel	Uso solo para cocinar/calentar a corto plazo. No deje el horno desatendido mientras cocina.	
 Toallas de papel	Úselo para cubrir alimentos para recalentar y absorber grasa. Úselo con supervisión solo para una cocción a corto plazo.	
 Papel pergamino	Úselo como cubierta para evitar salpicaduras o como envoltorio para cocinar al vapor.	

MATERIALES QUE SE PUEDEN USAR EN EL HORNO DE MICROONDAS

UTENSILLOS	OBSERVACIONES
 <p data-bbox="153 499 232 523">Plástico</p>	<p data-bbox="336 371 901 571">Solo apto para microondas. Siga las instrucciones del fabricante. Debe estar etiquetado como "Microwave Safe (Apto para Microondas)". Algunos recipientes de plástico se ablandan a medida que la comida del interior se calienta. Las "bolsas para hervir" y las bolsas de plástico bien cerradas deben cortarse, perforarse o ventilarse según las instrucciones del paquete.</p> 
 <p data-bbox="88 707 298 730">Envoltura de plástico</p>	<p data-bbox="336 611 882 722">Solo apto para microondas. Úselo para cubrir los alimentos durante la cocción para retener la humedad. No permita que la envoltura de plástico toque los alimentos.</p> 
 <p data-bbox="123 866 263 890">Termómetros</p>	<p data-bbox="336 802 876 850">Solo apto para microondas (termómetros para carne y dulces)</p> 
 <p data-bbox="112 1018 274 1042">Papel encerado</p>	<p data-bbox="336 954 901 1002">Úselo como cubierta para evitar salpicaduras y retener la humedad.</p> 

MATERIALES QUE NO SE PUEDEN USAR EN EL HORNO DE MICROONDAS

UTENSILLOS	OBSERVACIONES
 <p>Bandeja de aluminio</p>	<p>Puede causar arcos eléctricos. Transfiera la comida a un plato apto para microondas.</p> 
 <p>Cartón de comida con asa de metal</p>	<p>Puede causar arcos eléctricos. Transfiera la comida a un plato apto para microondas.</p> 
 <p>Utensilios de metal o con adornos de metal</p>	<p>El metal protege los alimentos de la energía de microondas. Las molduras metálicas pueden provocar arcos eléctricos.</p> 
 <p>Lazos de torsión de metal</p>	<p>Puede provocar un arco eléctrico y un incendio en el horno.</p> 
 <p>Bolsas de papel</p>	<p>Puede provocar un incendio en el horno.</p> 
 <p>Espuma plástica</p>	<p>La espuma plástica puede derretir o contaminar el líquido del interior cuando se expone a altas temperaturas.</p> 
 <p>Madera</p>	<p>La madera se secará cuando se use en el microondas y tendrá posibilidad de partirse o rajarse.</p> 

CONFIGURACIÓN DEL PRODUCTO

CONFIGURACIÓN DEL HORNO

NOMBRES DE LAS PIEZAS Y ACCESORIOS DEL HORNO

Retire el horno y todos los materiales del cartón y la cavidad del horno.

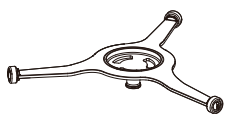

Conjunto de anillo del plato giratorio



Plato giratorio de vidrio

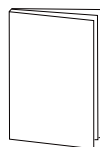

Manual de instrucciones

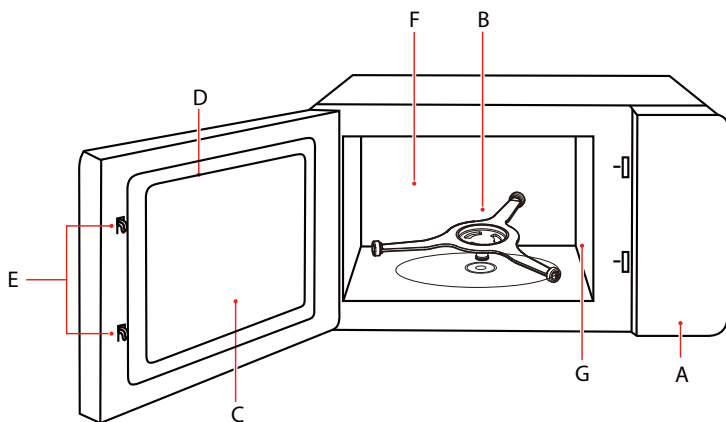

- A. Panel de control
- B. Conjunto del anillo del plato giratorio
- C. Ventana de observación
- D. Conjunto de la puerta

- E. Sistema de bloqueo de seguridad
- F. Cavidad del horno microondas
- G. Cubierta de la guía de ondas

CONFIGURACIÓN DEL HORNO

INSTALACIÓN DEL PLATO GIRATORIO

Limpie el compartimento de cocción y coloque el plato giratorio.

Para instalaciones nuevas, asegúrese de que se haya quitado todo el embalaje y la cinta de envío del eje del plato giratorio.

Antes de utilizar el aparato para preparar alimentos por primera vez, deberá colocar el plato giratorio en su lugar correctamente. Debe limpiar el compartimento de cocción y los accesorios. Puede consultarlo en la sección de limpieza.

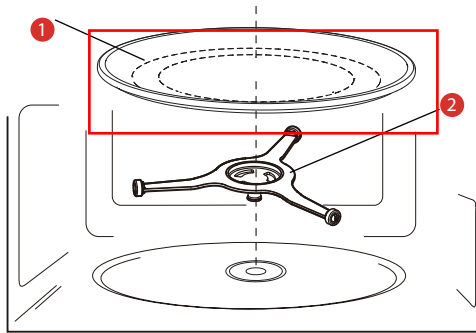

- 1) Bandeja de vidrio
- 2) Conjunto de anillo del plato giratorio

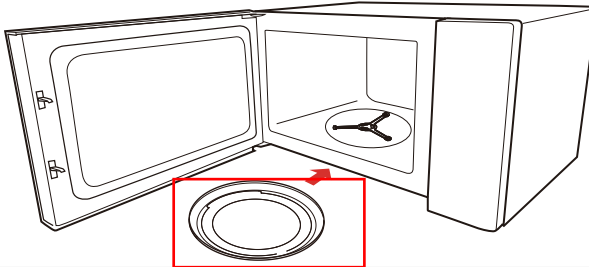

PRECAUCIÓN

- No utilice nunca el aparato sin el plato giratorio. Asegúrese de que esté correctamente acoplado. El plato giratorio puede girar en sentido horario o antihorario.
- No coloque la bandeja de vidrio en forma de boca abajo. La bandeja de vidrio nunca debe restringirse.
- Tanto la bandeja de vidrio como el conjunto del anillo de plato giratorio deben usarse siempre durante la cocción.
- Todos los alimentos y recipientes de alimentos se colocan siempre en la bandeja de vidrio para la cocción.
- Nunca contenga el movimiento del plato giratorio.
- Si la bandeja de vidrio o el conjunto del anillo de plato giratorio se agrietan o rompen, comuníquese con el centro de servicio autorizado más cercano.

CONFIGURACIÓN DEL HORNO

INSTALACIÓN DE ENCIMERO

Retire todo el material de embalaje y accesorios. Averigüe el horno para ver si hay daños, como abolladuras o puertas rotas. No instale si el horno está dañado.

Gabinete: Retire cualquier película protectora que se encuentre en la superficie del gabinete para el horno de microondas. No retire la cubierta de guía de ondas que está unida a la cavidad del horno para proteger el magnetrón.

INSTALACIÓN

1. Seleccione una superficie plana que proporcione suficiente espacio abierto para aberturas de entrada y/o salida.
 - a. La altura mínima de instalación es de 85 cm.
 - b. La superficie trasera del aparato se colocará contra una pared. quede un espacio libre mínimo de 30 cm por encima del horno. Se requiere un espacio libre mínimo de 20 cm entre el horno y las paredes adyacentes.
 - c. No quite las patas del fondo del horno.
 - d. Bloquear las aberturas de entrada y / o salida puede dañar el horno.
 - e. Coloque el horno lo más lejos posible de radios y televisores.

El funcionamiento de microondas puede causar interferencias en la recepción de su radio y televisión.

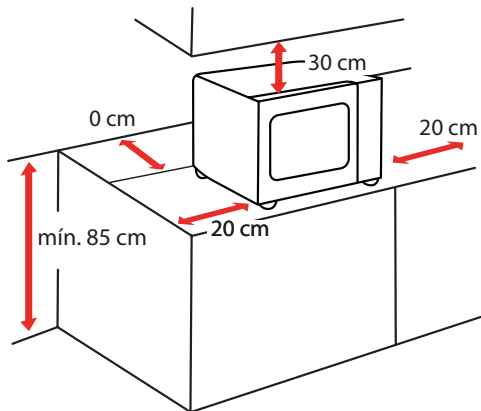

CONFIGURACIÓN DEL HORNO

2. Conecte el horno en una toma de corriente estándar del hogar. Asegúrese de que la tensión y la frecuencia sean conformes a los que están indicados en la etiqueta de clasificación.



ADVERTENCIA

- No instale el horno sobre un quemador u otro aparato que genera calor.
Si se instala cerca o sobre una fuente de calor, el horno podría dañarse, y la garantía quedaría anulada.

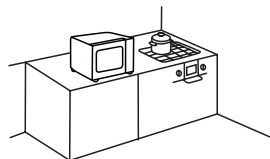

La superficie accesible puede estar caliente durante la operación.

INSTRUCCIONES PARA USO

ANTES DEL USO POR PRIMERA VEZ

Este aparato puede producir olores desagradables cuando se usa por primera vez.

Esta parte le ayudará a conocer qué tiene que hacer antes de usar su microondas para la preparación de alimento por primera vez. Lee anticipadamente el título de la parte "**INSTRUCCIONES IMPORTANTES DE SEGURIDAD**" en la página 3.

Antes de usar su aparato, tiene que colocar el plato giratorio en un lugar correcto. También debe limpiar el compartimento de cocción y accesorios.



NOTA



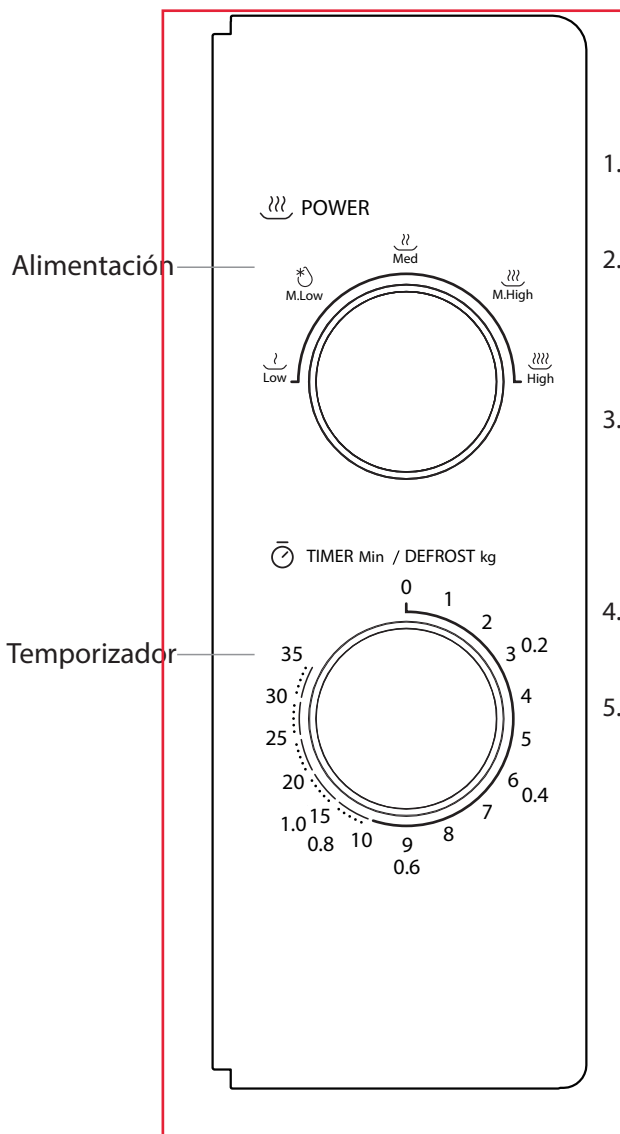

- No utilice nunca el aparato sin el plato giratorio.
- Asegúrese de que esté correctamente acoplado. El plato giratorio puede girar en sentido horario o antihorario.

OPERACIÓN

INSTRUCCIONES DE OPERACIÓN



1. Configure la potencia de cocción por girar la perilla de potencia al nivel deseado.
2. Configure el tiempo de cocción por girar la perilla del temporizador al tiempo deseado según la guía de cocción de alimentos.
3. El horno de microondas comenzará a cocinar automáticamente después de que se establezcan el nivel de potencia y el tiempo.
4. Una vez acabado el tiempo de cocción, la unidad emitirá "Dong" para detenerse.
5. Si la unidad no está en uso, configure siempre el tiempo en "0".

FUNCIÓN/POTENCIA	SALIDA	APLICACIÓN
BAJA		17% micro. Ablandar helado
MEDIA-BAJA		33% micro. Guisar sopa, ablandar mantequilla o descongelar
MEDIA		55% micro. Guiso, pescado
MEDIA-ALTA		77% micro. Arroz, pescado, pollo, carne molida
ALTA		100% micro. Recalentar leche, verduras, bebidas, hervir agua.



NOTA:

- Cuando saque los alimentos del horno, asegúrese de que el horno esté apagado girando el interruptor del temporizador a 0 (cero). Si no lo hace y si utiliza el horno de microondas sin comida, puede provocar un sobrecalentamiento y daños en el magnetrón.

LIMPIEZA

Con limpieza y mantenimiento adecuados, su aparato mantendrá plenamente su apariencia durante un largo período de tiempo. Explicaremos a continuación para decirle cómo hacer el mantenimiento y la limpieza de su aparato.



ADVERTENCIA

- El vidrio rayado en la puerta del aparato puede convertirse en una rotura. Se prohíbe usar raspadores de vidrio, productos de limpieza o detergentes afilados o abrasivos.
- La superficie del aparato puede ser dañada si no se limpia correctamente. Lo que aumentará la energía de microondas. Limpie el aparato de forma periódica y retire de inmediato los restos de comida.
- No sumerja el aparato en agua ni lo limpie bajo un chorro de agua.

Agente de limpieza

Para asegurarse de que las diferentes superficies no se dañen por el uso de agente de limpieza incorrecto, deberá observarse la siguiente información. Lave bien los paños de esponja nuevos antes de usarlos.

No utilice:



Agentes de limpieza fuertes o abrasivos



Raspadores metálicos o vidrio para limpiar el panel de puertas



Raspadores metálicos o vidrio para limpiar la junta de puerta



Esponjas abrasivas o estropajos duros



Agentes de limpieza con alta graduación alcohólica

PARTE DELANTERA DEL APARATO

Agua jabonosa caliente:

Utilice un paño de cocina para limpiar y luego seque con un paño suave.

No utilice raspadores metálicos o vidrio para la limpieza.

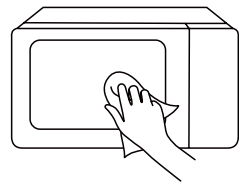

LIMPIEZA

CHAPA DE LA PARTE DELANTERA DEL APARATO

Agua caliente jabonosa:

Utilice un paño de cocina para limpiar y luego seque con un paño suave. Elimine inmediatamente las salpicaduras y manchas de cal, grasa, almidón y albúmina. La parte inferior de estos parches o salpicaduras puede causar la corrosión. No utilice limpiador de cristales, raspadores metálicos o vidrio para la limpieza.

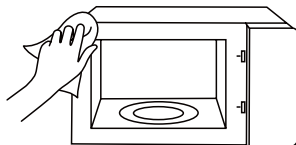

CAVIDAD DEL APARATO

Agua caliente jabonosa o solución de vinagre:

Utilice un paño de cocina para limpiar y luego seque con un paño suave. No utilice aerosol para horno ni ningún otro limpiador de horno agresivo o materiales abrasivos. Las esponjas abrasivas o las esponjas ásperas y los limpiadores de ollas tampoco son idóneos. Estos elementos pueden dañar la superficie. Deje que se sequen completamente las superficies interiores.

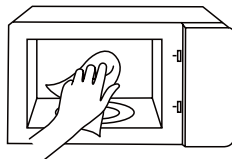

HUECO DE SOPORTE EN EL COMPARTIMENTO DE COCCIÓN

Paño húmedo:

No se permite que entre agua en el aparato debido al movimiento del plato giratorio. Seque el plato giratorio con un paño.

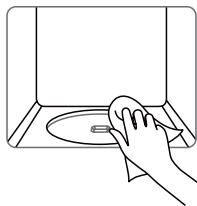

PLATO GIRATORIO Y ANILLO DE RODAMIENTO

Agua caliente jabonosa:

Cuando coloca el plato giratorio en su hueco de soporte, deberá ser la colocación correctamente.



PANEL DE PUERTA

Limpiador de cristales:

Utilice un paño de cocina para limpiar. No utilice raspadores de vidrio.

RESOLUCIÓN DE PROBLEMAS

Verifique su problema utilizando la tabla a continuación y pruebe las soluciones para cada uno. Si el microondas aún no funciona correctamente, comuníquese con el centro de servicio autorizado más cercano.

PROBLEMA	CAUSA POSIBLE	POSIBLE REMEDIO
El horno no arranca	<ul style="list-style-type: none"> a. El cable eléctrico del horno no está enchufado. b. La puerta está abierta. c. Se establece una operación incorrecta. 	<ul style="list-style-type: none"> a. Enchufarlo en el tomacorriente. b. Cerrar la puerta y vuelva a intentarlo. c. Consultar las instrucciones
Formación de arcos o chispas eléctricas	<ul style="list-style-type: none"> a. Se utilizaron materiales prohibidos en el horno microondas. b. El horno funciona cuando está vacío. c. La comida derramada permanece en la cavidad. 	<ul style="list-style-type: none"> a. Utilizar únicamente utensilios de cocina aptos para microondas. b. No operar con el horno vacío. c. Limpiar la cavidad con una toalla húmeda.
Alimentos mal cocidos	<ul style="list-style-type: none"> a. Se utilizaron materiales prohibidos en el horno microondas. b. Los alimentos no se descongelan por completo. c. No son adecuados el tiempo de cocción y el nivel de potencia. d. La comida no se da vuelta ni se revuelve. 	<ul style="list-style-type: none"> a. Utilizar únicamente utensilios de cocina aptos para microondas. b. Descongelar completamente los alimentos. c. Utilizar el tiempo de cocción y el nivel de potencia correctos. d. Voltrear o revuelva la comida.
Alimentos demasiado cocidos	No son adecuados el tiempo de cocción y el nivel de potencia.	Utilizar el tiempo de cocción y el nivel de potencia correctos.
Alimentos poco cocidos	<ul style="list-style-type: none"> a. Se utilizaron materiales prohibidos en el horno microondas. b. Los alimentos no se descongelan por completo. c. Los puertos de ventilación del horno están restringidos. d. No son adecuados el tiempo de cocción y el nivel de potencia. 	<ul style="list-style-type: none"> a. Utilizar únicamente utensilios de cocina aptos para microondas. b. Descongelar completamente los alimentos. c. Verificar que los puertos de ventilación del horno no estén restringidos. d. Utilizar el tiempo de cocción y el nivel de potencia correctos.
Descongelación inadecuada	<ul style="list-style-type: none"> a. Se utilizaron materiales prohibidos en el horno microondas. b. No son adecuados el tiempo de cocción y el nivel de potencia. c. La comida no se da vuelta ni se revuelve. 	<ul style="list-style-type: none"> a. Utilizar únicamente utensilios de cocina aptos para microondas. b. Utilizar el tiempo de cocción y el nivel de potencia correctos. c. Voltrear o revuelva la comida.



De acuerdo con la directiva de Residuos de Aparatos Eléctricos y Electrónicos (RAEE), los residuos de aparatos eléctricos y electrónicos deben recolectarse y tratarse por separado. Si en algún momento en el futuro necesita deshacerse de este producto, NO lo deseché con la basura doméstica. Envíe este producto a los puntos de recogida de residuos de aparatos eléctricos y electrónicos donde estén disponibles.

#DetailsMatter

ΦΟΥΡΝΟΣ ΜΙΚΡΟΚΥΜΑΤΩΝ

MW-MM20P(BK)/MW-MM20P(WH)

Παρακαλείστε να διαβάσετε το παρόν εγχειρίδιο οδηγιών χρήσης πριν από τη λειτουργία.

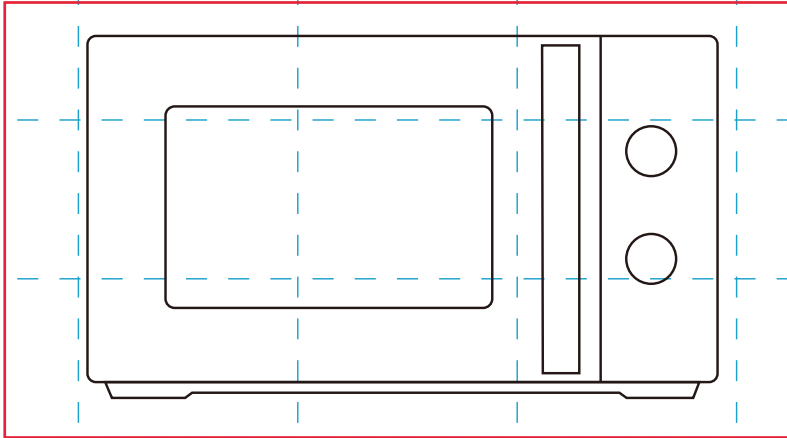

ΠΕΡΙΕΧΟΜΕΝΑ

ΑΣΦΑΛΕΙΑ ΠΡΟΪΟΝΤΩΝ

Προληπτικά μέτρα για να αποφευχθεί πιθανή έκθεση σε υπερβολική ενέργεια μικροκυμάτων.....	EL-01
Σημαντικές οδηγίες ασφαλείας.....	EL-03
Για να μειωθεί ο κίνδυνος τραυματισμού ατόμων από την εγκατάσταση γείωσης.....	EL-08
Καθαρισμός.....	EL-10
Σκευη.....	EL-11
Σκεύη που μπορείτε να χρησιμοποιείτε στο φούρνο μικροκυμάτων.....	EL-12
Σκεύη που δεν μπορείτε να χρησιμοποιείτε στο φούρνο μικροκυμάτων.....	EL-14

ΡΥΘΜΙΣΗ ΠΡΟΪΟΝΤΟΣ

Ρύθμιση του φούρνου σας.....	EL-15
------------------------------	-------

ΟΔΗΓΙΕΣ ΧΡΗΣΗΣ

Πριν από την πρώτη χρήση.....	EL-19
Λειτουργία.....	EL-20
Καθαρισμός.....	EL-22

ΣΥΝΤΗΡΗΣΗ

Επίλυση προβλημάτων.....	EL-24
--------------------------	-------



ΣΗΜΕΙΩΣΗ

ΠΡΙΝ ΤΗ ΧΡΗΣΗ ΑΥΤΟΥ ΤΟΥ ΠΡΟΪΟΝΤΟΣ,
ΔΙΑΒΑΣΤΕ, ΚΑΤΑΝΟΗΣΤΕ ΚΑΙ ΑΚΟΛΟΥΘΗΣΤΕ
ΑΥΤΕΣ ΤΙΣ ΟΔΗΓΙΕΣ.
ΦΥΛΑΞΤΕ ΤΟ ΠΑΡΟΝ ΕΓΧΕΙΡΙΔΙΟ ΓΙΑ ΜΕΛΛΟΝΤΙΚΗ
ΑΝΑΦΟΡΑ.

ΠΡΟΦΥΛΑΞΕΙΣ ΓΙΑ ΤΗΝ ΑΠΟΦΥΓΗ ΠΙΘΑΝΗΣ ΕΚΘΕΣΗΣ ΣΕ ΥΠΕΡΒΟΛΙΚΗ ΕΝΕΡΓΕΙΑ ΜΙΚΡΟΚΥΜΑΤΩΝ

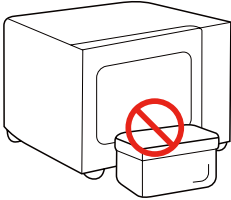
- (α). Μην επιχειρήσετε να λειτουργήσετε αυτόν τον φούρνο με την πόρτα ανοιχτή, καθώς αυτό μπορεί να οδηγήσει σε επιβλαβή έκθεση σε ενέργεια μικροκυμάτων. Είναι σημαντικό να μην σπάσετε ή να μην πειράξετε τα συστήματα κλειδώματος.
- (β). Μην τοποθετήσετε κανένα αντικείμενο μεταξύ της πρόσοψης του φούρνου μικροκυμάτων και της πόρτας και μην αφήσετε να συσσωρευθεί σκόνη ή υπολείμματα καθαριστικών στις επιφάνειες ή τα εξαρτήματα μόνωσης (λάστιχα).
- 
- (γ). **ΠΡΟΕΙΔΟΠΟΙΗΣΗ:** Αν υποστεί φθορά η πόρτα ή τα εξαρτήματα μόνωσης (λάστιχα), δεν θα πρέπει να χρησιμοποιήσετε τον φούρνο πριν επισκευαστούν από εξειδικευμένο άτομο.

ΠΡΟΣΘΗΚΗ

Εάν η συσκευή δεν διατηρείται σε καλή κατάσταση καθαριότητας, η επιφάνειά της μπορεί να υποβαθμιστεί και να επηρεάσει τη διάρκεια ζωής της συσκευής και να οδηγήσει σε επικίνδυνη κατάσταση.

ΠΡΟΔΙΑΓΡΑΦΕΣ

ΜΟΝΤΕΛΟ	MW-MM20P(BK)/MW-MM20P(WH)
Ονομαστική τάση/συχνότητα	230-240 V~ 50 Hz
Ονομαστική είσοδος μικροκυμάτων	1200-1270 W
Ονομαστική έξοδος μικροκυμάτων	750-800 W



ΣΗΜΕΙΩΣΗ

Σε περίπτωση οποιασδήποτε ασυμφωνίας μεταξύ του εξοπλισμού και των εικόνων του παρόντος εγχειριδίου, το προϊόν θα υπερισχύει.

ΣΗΜΑΝΤΙΚΕΣ ΟΔΗΓΙΕΣ ΑΣΦΑΛΕΙΑΣ



ΠΡΟΕΙΔ- ΟΠΟΙΗΣΗ

Για να μειωθεί ο κίνδυνος πυρκαγιάς, ηλεκτροπληξίας, τραυματισμού σε άτομα ή η έκθεση σε υπερβολική ενέργεια του φούρνου μικροκυμάτων όταν χρησιμοποιείτε τη συσκευή σας, ακολουθήστε τις βασικές προφυλάξεις, συμπεριλαμβανομένων των εξής:



Διαβάστε και ακολουθήστε συγκεκριμένα:

**«ΠΡΟΛΗΠΤΙΚΑ ΜΕΤΡΑ
ΓΙΑ ΝΑ ΑΠΟΦΕΥΧΘΕΙ
ΠΙΘΑΝΗ ΕΚΘΕΣΗ ΣΕ
ΥΠΕΡΒΟΛΙΚΗ ΕΝΕΡΓΕΙΑ
ΜΙΚΡΟΚΥΜΑΤΩΝ».**



Αυτή η συσκευή μπορεί να χρησιμοποιηθεί από παιδιά ηλικίας από 8 ετών και άνω καθώς και από άτομα με μειωμένες φυσικές, αισθητηριακές ή διανοητικές ικανότητες ή με έλλειψη εμπειρίας και γνώσης, εφόσον υπάρχει επίβλεψη ή έχουν δοθεί οδηγίες σχετικά με τη χρήση της συσκευής με ασφαλή τρόπο και εφόσον έχουν κατανοήσει τους σχετικούς κινδύνους.

Τα παιδιά δεν πρέπει να παίζουν με τη συσκευή. Ο καθαρισμός και η συντήρηση δεν θα πρέπει να γίνονται από παιδιά χωρίς επίβλεψη.



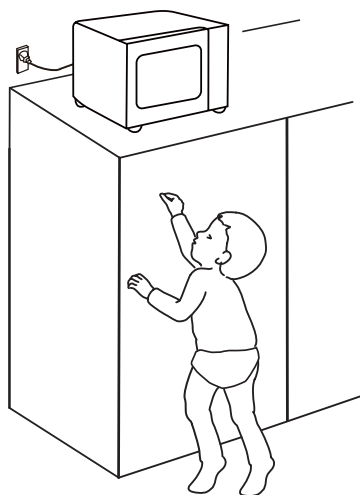

Διατηρείτε τη συσκευή και το καλώδιό της μακριά από παιδιά μικρότερα των 8 ετών.





ΣΗΜΑΝΤΙΚΕΣ ΟΔΗΓΙΕΣ ΑΣΦΑΛΕΙΑΣ

 Εάν το καλώδιο ρεύματος υποστεί φθορά, μπορεί να αντικατασταθεί από τον κατασκευαστή, ένα αντιπρόσωπο σέρβις ή έναν αντίστοιχο εξειδικευμένο τεχνικό για να αποφευχθεί ο κίνδυνος.

 **ΠΡΟΕΙΔΟΠΟΙΗΣΗ:** Βεβαιωθείτε ότι η συσκευή είναι απενεργοποιημένη πριν αντικαταστήσετε τη λυχνία για να αποτραπεί το ενδεχόμενο ηλεκτροπληξίας.

 **ΠΡΟΕΙΔΟΠΟΙΗΣΗ:** Είναι επικίνδυνο για οποιονδήποτε άλλο εκτός από ένα καταρτισμένο άτομο να εκτελέσει οποιαδήποτε εργασία συντήρησης ή επισκευής η οποία περιλαμβάνει την αφαίρεση καλύμματος το οποίο παρέχει προστασία από έκθεση σε ενέργεια μικροκυμάτων.

 **ΠΡΟΕΙΔΟΠΟΙΗΣΗ:** Τα υγρά και τα υπόλοιπα τρόφιμα δεν πρέπει να θερμαίνονται σε σφραγισμένα δοχεία εφόσον έχουν την τάση να εκρήγνυνται.

 Όταν θερμαίνετε φαγητό σε πλαστικά ή χάρτινα δοχεία, προσέχετε τον φούρνο λόγω πιθανότητας ανάφλεξης.



 Να χρησιμοποιείτε μόνον σκεύη που είναι κατάλληλα για χρήση σε φούρνους μικροκυμάτων.

 Αν παράγεται καπνός, απενεργοποιήστε ή αποσυνδέστε τη συσκευή και κρατήστε την πόρτα κλειστή για να καταπνίξετε τυχόν φλόγες.

ΣΗΜΑΝΤΙΚΕΣ ΟΔΗΓΙΕΣ ΑΣΦΑΛΕΙΑΣ

 Η θέρμανση υγρών με μικροκύματα μπορεί να έχει ως αποτέλεσμα επιβραδυμένο, εκρηκτικό βρασμό, επομένως πρέπει να προσέχετε όταν πιάνετε το αντίστοιχο.

 Τα περιεχόμενα των μπιμπερό και των βάζων με παιδικές τροφές θα πρέπει να ανακινούνται ή να αναδεύονται και η θερμοκρασία να ελέγχεται πριν την κατανάλωση ούτως ώστε να αποφευχθούν εγκαύματα.

Είναι σημαντικό να καθαρίζετε τακτικά το φούρνο και να απομακρύνετε τυχόν υπολείμματα τροφών. Σας ευχαριστούμε που διατηρείτε την περιοχή του κυματοδηγού τακτοποιημένη. Εάν υπάρχουν υπολείμματα πιτσιλίσματος φαγητού στην περιοχή του κυματοδηγού ή στην κοιλότητα, καθαρίστε τα με ένα μαλακό, υγρό πανί. Εάν δεν

 απομακρύνετε τα υπολείμματα τροφών, μπορεί να προκληθεί αθώς σπινθηρισμός, μικρή ποσότητα καπνού ή/και αποχρωματισμός της κοιλότητας του φούρνου μικροκυμάτων.

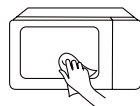

 Αδυναμία συντήρησης του φούρνου σε καθαρή κατάσταση θα μπορούσε να οδηγήσει σε φθορά της επιφάνειας που θα μπορούσε να επηρεάσει αρνητικά τη ζωή της συσκευής και πιθανόν να οδηγήσει σε επικίνδυνη κατάσταση.

 Χρησιμοποιείτε μόνον τον ανιχνευτή θερμοκρασίας που συνίσταται για αυτό τον φούρνο. (για φούρνους που διατίθενται με μία εγκατάσταση για τη χρήση ενός ανιχνευτή θερμοκρασίας.)

ΣΗΜΑΝΤΙΚΕΣ ΟΔΗΓΙΕΣ ΑΣΦΑΛΕΙΑΣ

 Η συσκευή δεν πρέπει να εγκατασταθεί πίσω από διακοσμητική πόρτα, για να αποφευχθεί υπερθέρμανση. (Αυτό δεν ισχύει για συσκευές που διαθέτουν διακοσμητική πόρτα.)

 Η παρούσα συσκευή προορίζεται για οικιακή ή παρόμοια χρήση, όπως:

1. χώρους κουζίνας προσωπικού σε καταστήματα, γραφεία και άλλα περιβάλλοντα εργασίας,
2. Από πελάτες σε ξενοδοχεία, μοτέλ και άλλα οικιστικά περιβάλλοντα. - Εξοχικά σπίτια. - Περιβάλλοντα τύπου Bed and breakfast.

 Ο φούρνος μικροκυμάτων προορίζεται για τη θέρμανση τροφίμων και ποτών. Η χρήση του για στέγνωμα τροφίμων ή

ενδυμάτων, θέρμανση μαξιλαριών, παπουτσιών, σφουγγαριών, υγρών ρούχων και παρόμοιων αντικειμένων μπορεί να οδηγήσει σε κίνδυνο τραυματισμού, ανάφλεξη ή πυρκαγιά.

 Η συσκευή προορίζεται για χρήση σε όρθια θέση.

 Η πίσω πλευρά της συσκευής δεν θα πρέπει να ακουμπά στον τοίχο.

 Ολόκληρα αυγά με το τσόφλι και βραστά αυγά δεν πρέπει να θερμαίνονται σε φούρνους μικροκυμάτων, καθώς ενδέχεται να εκραγούν, ακόμη και μετά το τέλος της θέρμανσης από μικροκύματα.

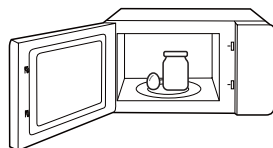

ΣΗΜΑΝΤΙΚΕΣ ΟΔΗΓΙΕΣ ΑΣΦΑΛΕΙΑΣ

 Ο φούρνος μικροκυμάτων δεν θα τοποθετείται σε ένα ντουλάπι, εκτός κι αν έχει δοκιμαστεί για χρήση σε ντουλάπι.

 Δεν θα πρέπει να χρησιμοποιούνται μεταλλικά δοχεία για το μαγείρεμα τροφίμων και υγρών σ' αυτό το φούρνο μικροκυμάτων.

 Η συσκευή δεν θα πρέπει να καθαρίζεται με ατμό.

**ΔΙΑΒΑΣΤΕ ΠΡΟΣΕΚΤΙΚΑ ΚΑΙ ΦΥΛΑΞΤΕ
ΓΙΑ ΝΑ ΑΝΑΤΡΕΧΕΤΕ ΣΤΟ ΜΕΛΛΟΝ**

Για να μειώσετε τον κίνδυνο τραυματισμού. Εγκατάσταση γείωσης

Αυτή η συσκευή πρέπει να είναι γειωμένη. Σε περίπτωση βραχυκυκλώματος, η γείωση μειώνει τον κίνδυνο ηλεκτροπληξίας, καθώς παρέχει ένα καλώδιο διαφυγής για το ηλεκτρικό ρεύμα. Αυτή η συσκευή είναι εξοπλισμένη με καλώδιο με φως που διαθέτει γείωση. Το φως πρέπει να είναι συνδεδεμένο σε μια πρίζα σωστά τοποθετημένη και γειωμένη.

ΠΡΟΕΙΔΟΠΟΙΗΣΗ - Η ακατάλληλη χρήση της γείωσης μπορεί να οδηγήσει σε κίνδυνο ηλεκτροπληξίας. Συμβουλευτείτε έναν εξειδικευμένο ηλεκτρολόγο ή συντηρητή εάν οι οδηγίες γείωσης δεν είναι πλήρως κατανοητές ή εάν υπάρχουν αμφιβολίες για το αν η συσκευή είναι σωστά γειωμένη.

Εάν απαιτείται να χρησιμοποιήσετε μπαλαντέζα, χρησιμοποιήστε μόνο μπαλα-ντέζα που έχει 3 καλώδια (ουδέτερο- φάση- γείωση).



ΚΙΝΔΥΝΟΣ

Κίνδυνος ηλεκτροπληξίας:

Το άγγιγμα ορισμένων από τα εσωτερικά εξαρτήματα μπορεί να προκαλέσει σοβαρό τραυματισμό ή θάνατο. Μην αποσυναρμολογείτε αυτή τη συσκευή.

ΓΙΑ ΝΑ ΜΕΙΩΘΕΙ Ο ΚΙΝΔΥΝΟΣ ΤΡΑΥΜΑΤΙΣΜΟΥ ΕΓΚΑΤΑΣΤΑΣΗ ΓΕΙΩΣΗΣ



**ΠΡΟΕΙΔΟΠ
ΟΙΗΣΗ**

Κίνδυνος ηλεκτροπληξίας:

Η ακατάλληλη χρήση της γείωσης μπορεί να προκαλέσει ηλεκτροπληξία. Μην συνδέετε το φως στην πρίζα μέχρι η συσκευή να εγκατασταθεί και να γειωθεί σωστά.

1. Παρέχεται ένα κοντό καλώδιο τροφοδοσίας για τη μείωση των κινδύνων που προκύπτουν από το να μπλέξετε ή να σκοντάψετε σε ένα μακρύτερο καλώδιο.
2. Εάν χρησιμοποιείται μακρύ καλώδιο ή :
 - (1). Η ονομαστική ισχύς που μπορεί να δεχτεί η μπαλαντέζα πρέπει να είναι μεγαλύτερη από την ισχύ της συσκευής
 - (2). Η μπαλαντέζα θα πρέπει να διαθέτει 3 καλώδια (ουδέτερο-φάση- γείωση)
 - (3). Το μακρύτερο καλώδιο θα πρέπει να είναι τοποθετημένο έτσι ώστε να μην κρέμεται πάνω από τον πάγκο ή το τραπέζι όπου μπορεί να τραβηχτεί από παιδιά ή να σκοντάψουν ακούσια.

ΚΑΘΑΡΙΣΜΟΣ

Βεβαιωθείτε ότι έχετε αποσυνδέσει τη συσκευή από την παροχή ρεύματος.

1. Καθαρίστε την κοιλότητα του φούρνου μετά τη χρήση με ένα ελαφρώς υγρό πανί.
2. Καθαρίστε τα εξαρτήματα με τον συνήθη τρόπο σε σαπουνόνερο.
3. Το πλαίσιο της πόρτας και τα γειτονικά εξαρτήματα θα πρέπει να καθαρίζονται προσεκτικά με ένα νοτισμένο πανί.
4. Μην χρησιμοποιείτε σκληρά λειαντικά καθαριστικά ή αιχμηρές μεταλλικές ξύστρες για να καθαρίσετε το γυαλί της πόρτας του φούρνου, καθώς μπορεί να χαράξουν την επιφάνεια, με αποτέλεσμα να σπάσει το γυαλί.
5. Συμβουλή για τον καθαρισμό---Για πιο εύκολο καθαρισμό του εσωτερικού του φούρνου: Βάλτε μισό λεμόνι σε ένα μπολ, προσθέστε 300ml νερό και ζεστάνετε με ισχύ 100% στο φούρνο μικροκυμάτων για 10 λεπτά. Σκουπίστε το φούρνο χρησιμοποιώντας ένα απαλό, στεγνό πανί.

ΣΚΕΥΗ



ΠΡΟΣΟΧΗ

Κίνδυνος προσωπικού τραυματισμού:
Είναι επικίνδυνο για οποιονδήποτε άλλον εκτός από αρμόδιο άτομο να εκτελεί οποιαδήποτε εργασία σέρβις ή επισκευής που περιλαμβάνει την αφαίρεση ενός καλύμματος που παρέχει προστασία από την έκθεση σε ενέργεια μικροκυμάτων. **Ανατρέξτε στις οδηγίες «Υλικά που μπορείτε να χρησιμοποιήσετε σε φούρνο μικροκυμάτων» ή «Υλικά που δεν μπορούν να χρησιμοποιηθούν σε φούρνο μικροκυμάτων».** Ενδέχεται να υπάρχουν ορισμένα μη μεταλλικά σκεύη που δεν είναι ασφαλή για χρήση σε φούρνο μικροκυμάτων. Αν δεν είστε βέβαιοι, μπορείτε να δοκιμάσετε το επιθυμητό σκεύος ακολουθώντας την εξής διαδικασία:

Δοκιμή σκευών:

1. Γεμίστε ένα δοχείο κατάλληλο για φούρνο μικροκυμάτων με 1 φλιτζάνι κρύο νερό (250 ml) μαζί με το εν λόγω σκεύος.
2. Μαγειρέψτε στη μέγιστη ισχύ για 1 λεπτό.
3. Ψηλαφίστε προσεκτικά το σκεύος. Εάν το άδειο σκεύος είναι ζεστό, μην το χρησιμοποιήσετε για μαγείρεμα σε φούρνο μικροκυμάτων.
4. Μην υπερβαίνετε τον χρόνο μαγειρέματος του 1 λεπτού.

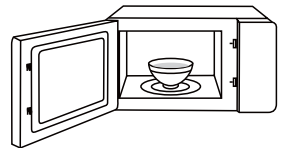

ΣΗΜΕΙΩΣΗ

ΔΙΑΤΗΡΕΙΤΕ ΤΗΝ ΚΟΙΛΟΤΗΤΑ ΚΑΙ ΤΗΝ ΠΕΡΙΟΧΗ ΤΟΥ ΚΥΜΑΤΟΔΗΓΟΥ ΚΑΘΑΡΗ

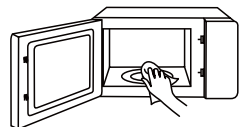

ΥΛΙΚΑ ΠΟΥ ΜΠΟΡΕΙΤΕ ΝΑ ΧΡΗΣΙΜΟΠΟΙΗΣΕΤΕ ΣΕ ΦΟΥΡΝΟ ΜΙΚΡΟΚΥΜΑΤΩΝ

ΣΚΕΥΗ

ΠΑΡΑΤΗΡΗΣΕΙΣ



Πυρέξ

Ακολουθείτε τις οδηγίες του κατασκευαστή. Ο πυθμένας του Πυρέξ πρέπει να βρίσκεται τουλάχιστον 3/16 ίντσας (5 mm) πάνω από τον περιστρεφόμενο δίσκο. Η λανθασμένη χρήση μπορεί να προκαλέσει το σπάσιμο του περιστρεφόμενου δίσκου.



Σερβίτσια

Μόνο ειδικά για φούρνους μικροκυμάτων. Ακολουθείτε τις οδηγίες του κατασκευαστή. Μην χρησιμοποιείτε ραγισμένα ή σπασμένα σκεύη.



Γυάλινα βάζα

Αφαιρείτε πάντα το καπάκι. Χρησιμοποιήστε τον μόνο για να ζεστάνετε το φαγητό μέχρι να είναι μόλις ζεστό. Τα περισσότερα γυάλινα βάζα δεν είναι ανθεκτικά στη θερμότητα και μπορεί να σπάσουν.



Γυάλινα σκεύη

Μόνο γυάλινα σκεύη φούρνου ανθεκτικά στη θερμότητα. Βεβαιωθείτε ότι δεν υπάρχουν μεταλλικά διακοσμητικά στοιχεία. Μην χρησιμοποιείτε ραγισμένα ή σπασμένα σκεύη.



Σακούλες μαγειρέματος φούρνου

Ακολουθείτε τις οδηγίες του κατασκευαστή. Μην κλείνετε με μεταλλικά πιαστράκια. Κάντε σχισμές για να επιτρέψει τη διαφυγή του ατμού.



Χάρτινα πιάτα και ποτήρια

Χρήση μόνο για βραχυπρόθεσμο μαγείρεμα/ζέσταμα. Μην αφήνετε τον φούρνο χωρίς επίβλεψη κατά τη διάρκεια του μαγειρέματος.



Χαρτοπετσέτες

Χρησιμοποιήστε τη για να καλύψετε τρόφιμα για αναθέρμανση και απορρόφηση λίπους. Χρησιμοποιήστε το με επίβλεψη μόνο για βραχυπρόθεσμο μαγείρεμα.



Λαδόκολλα

Χρησιμοποιήστε το ως κάλυμμα για να αποφύγετε το πιτσίσισμα ή ως περιτύλιγμα για το μαγείρεμα στον ατμό.



ΥΛΙΚΑ ΠΟΥ ΜΠΟΡΕΙΤΕ ΝΑ ΧΡΗΣΙΜΟΠΟΙΗΣΕΤΕ ΣΕ ΦΟΥΡΝΟ ΜΙΚΡΟΚΥΜΑΤΩΝ

ΣΚΕΥΗ

ΠΑΡΑΤΗΡΗΣΕΙΣ



Πλαστικό

Μόνο ασφαλή για μικροκύματα. Ακολουθείτε τις οδηγίες του κατασκευαστή. Θα πρέπει να φέρει την ένδειξη «Microwave Safe» (Ασφαλής για μικροκύματα). Ορισμένα πλαστικά δοχεία μαλακώνουν, καθώς το φαγητό μέσα τους ζεσταίνεται. Οι «σακούλες βρασμού» και οι ερμητικά κλειστές πλαστικές σακούλες πρέπει να σχίζονται, να τρυπιούνται ή να αερίζονται σύμφωνα με τις οδηγίες της συσκευασίας.



Πλαστικό περιτύλιγμα

Μόνο ασφαλή για μικροκύματα. Χρησιμοποιήστε το για να καλύψετε τα τρόφιμα κατά τη διάρκεια του μαγειρέματος για να διατηρήσετε την υγρασία. Μην αφήνετε τη μεμβράνη να αγγίζει το φαγητό.



Θερμόμετρα

Μόνο για θερμόμετρα που είναι ασφαλή για μικροκύματα (θερμόμετρα κρέατος και γλυκών).



Κηρόχαρτο

Χρησιμοποιήστε το ως κάλυμμα για να αποφύγετε το πιτσίσισμα και να διατηρήσετε την υγρασία.



ΤΑ ΥΛΙΚΑ ΔΕΝ ΜΠΟΡΟΥΝ ΝΑ ΧΡΗΣΙΜΟΠΟΙΗΘΟΥΝ ΣΕ ΦΟΥΡΝΟ ΜΙΚΡΟΚΥΜΑΤΩΝ

ΣΚΕΥΗ

ΠΑΡΑΤΗΡΗΣΕΙΣ



Δίσκος αλουμινίου

Μπορεί να προκληθεί ηλεκτρικό τόξο. Μεταφέρετε το φαγητό σε σκεύος ασφαλές για μικροκύματα.



Σκεύος τροφίμων με μεταλλική λαβή

Μεταφέρετε το φαγητό σε σκεύος ασφαλές για μικροκύματα.



Μέταλλο ή σκεύη με μεταλλική διακόσμηση

Το μέταλλο προστατεύει το φαγητό από την ενέργεια των μικροκυμάτων. Η μεταλλική διακόσμηση μπορεί να προκαλέσει ηλεκτρικό τόξο.



Πλαστικοποιημένο σύρμα – μεταλλικά πιαστράκια

Μπορεί να προκληθεί ηλεκτρικό τόξο και φωτιά στο εσωτερικό του φούρνου μικροκυμάτων.



Χάρτινες σακούλες

Ενδέχεται να προκαλέσει φωτιά στον φούρνο.



Πλαστικός αφρός

Ο πλαστικός αφρός μπορεί να λιώσει ή να μολύνει το υγρό στο εσωτερικό του όταν εκτεθεί σε υψηλή θερμοκρασία.



Ξύλο

Το ξύλο ξηραίνεται όταν χρησιμοποιείται στον φούρνο μικροκυμάτων και μπορεί να σπάσει ή να ραγίσει.



ΡΥΘΜΙΣΗ ΠΡΟΪΟΝΤΟΣ

ΡΥΘΜΙΣΗ ΤΟΥ ΦΟΥΡΝΟΥ ΣΑΣ

ΟΝΟΜΑΣΙΕΣ ΑΝΤΑΛΛΑΚΤΙΚΩΝ ΚΑΙ ΕΞΑΡΤΗΜΑΤΩΝ ΤΟΥ ΦΟΥΡΝΟΥ ΜΙΚΡΟΚΥΜΑΤΩΝ

Αφαιρέστε τον φούρνο και όλα τα υλικά από το χαρτοκιβώτιο και την κοιλότητα του φούρνου.

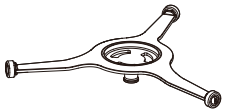

Διάταξη δακτυλίου
περιστρεφόμενου δίσκου



Γυάλινος δίσκος

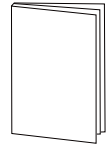

Εγχειρίδιο οδηγιών

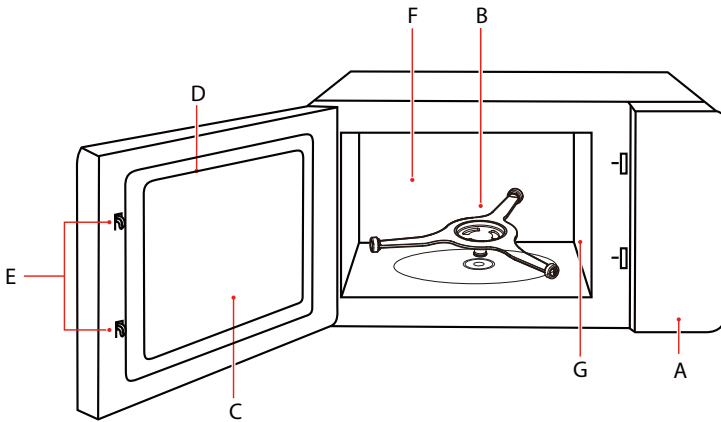

- A) Πίνακας χειρισμού
- B) Διάταξη δακτυλίου περιστρεφόμενου δίσκου
- C) Παράθυρο παρατήρησης
- D) Διάταξη πόρτας

- E) Σύστημα κλειδώματος ασφαλείας
- F) Θάλαμος φούρνου
- G) Κάλυμμα κυματοδηγού

ΡΥΘΜΙΣΗ ΤΟΥ ΦΟΥΡΝΟΥ ΣΑΣ

ΤΟΠΟΘΕΤΗΣΗ ΤΟΥ ΠΕΡΙΣΤΡΕΦΟΜΕΝΟΥ ΔΙΣΚΟΥ

Καθαρισμός του χώρου μαγειρέματος και τοποθέτηση του περιστρεφόμενου δίσκου στη θέση του. Για νέες εγκαταστάσεις, βεβαιωθείτε ότι έχει αφαιρεθεί όλη η ταινία συσκευασίας και αποστολής από τον άξονα του περιστρεφόμενου δίσκου.

Πριν χρησιμοποιήσετε τη συσκευή για την προετοιμασία φαγητού για φιρκτή φορά, θα πρέπει να τοποθετήσετε σωστά τον περιστρεφόμενο δίσκο στη θέση του. Πρέπει να καθαρίσετε το χώρο μαγειρέματος και τα εξαρτήματα.

Πώς να τοποθετήσετε τον περιστρεφόμενο δίσκο στη θέση του:

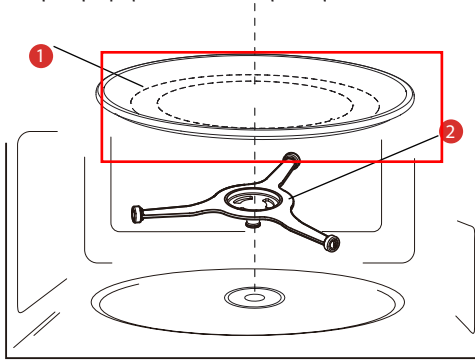

1) Γυάλινος δίσκος

2) Διάταξη δακτυλίου περιστρεφόμενου δίσκου

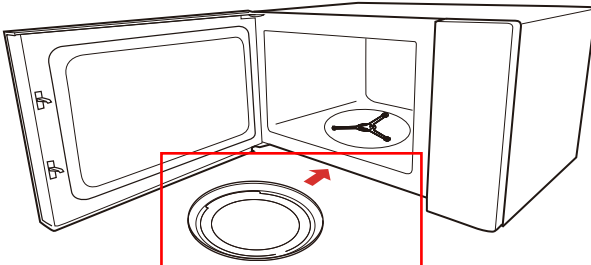

- Ποτέ μη χρησιμοποιείτε τη συσκευή χωρίς τον περιστρεφόμενο δίσκο. Βεβαιωθείτε ότι είναι σωστά **συνδεδεμένος**. Ο **περιστρεφόμενος** δίσκος μπορεί να περιστρέφεται δεξιόστροφα ή αριστερόστροφα.
- Ποτέ μην τοποθετείτε τον γυάλινο δίσκο ανάποδα. Ο γυάλινος δίσκος δεν πρέπει ποτέ να περιορίζεται.
- Και οι δύο διατάξεις γυάλινου δίσκου και δακτυλίου περιστρεφόμενου δίσκου πρέπει πάντα να χρησιμοποιούνται κατά τη διάρκεια του μαγειρέματος.
- Όλα τα τρόφιμα και τα δοχεία τροφίμων τοποθετούνται πάντα στο γυάλινο δίσκο για το μαγείρεμα.
- Ποτέ μην περιορίζετε την κίνηση του περιστρεφόμενου δίσκου.
- Αν ο γυάλινος δίσκος ή το συγκρότημα δακτυλίου του περιστρεφόμενου δίσκου ραγίσει ή σπάσει, επικοινωνήστε με το πλησιέστερο εξουσιοδοτημένο κέντρο σέρβις.



ΣΗΜΕΙΩΣΗ

ΡΥΘΜΙΣΗ ΤΟΥ ΦΟΥΡΝΟΥ ΣΑΣ

ΕΓΚΑΤΑΣΤΑΣΗ ΣΤΟΝ ΠΑΓΚΟ

Αφαιρέστε όλα τα υλικά συσκευασίας και τα εξαρτήματα. Εξετάστε το φούρνο για πιθανές φθορές όπως π.χ. βαθουλώματα ή σπασμένη πόρτα. Αν έχει φθορές, μην τον εγκαταστήσετε. Εσωτερικό φούρνου: Αφαιρέστε τυχόν προστατευτικές μεμβράνες από το εσωτερικό του φούρνου. Μην αφαιρέσετε το κάλυμμα Mica (ανοιχτού καφέ χρώματος) που είναι τοποθετημένο στο εσωτερικό του φούρνου για να προστατεύει το μάγνητρο.

ΕΓΚΑΤΑΣΤΑΣΗ

1. Επιλέξτε μια επίπεδη επιφάνεια που να παρέχει αρκετό ελεύθερο χώρο για τους αεραγωγούς εισαγωγής ή/και εξαγωγής.
 - α. Το ελάχιστο ύψος εγκατάστασης είναι 85 cm.
 - β. Η οπίσθια επιφάνεια της συσκευής πρέπει να τοποθετείται σε τοίχο. Αφήστε μια ελάχιστη απόσταση 30 cm πάνω από τον φούρνο. Μεταξύ του φούρνου και οποιουδήποτε παρακείμενου τοίχου απαιτείται ελάχιστη απόσταση 20 cm.
 - γ. Μην αφαιρείτε τα πόδια από το κάτω μέρος του φούρνου.
 - δ. Το μπλοκάρισμα των ανοιγμάτων εισόδου ή/και εξόδου μπορεί να προκαλέσει ζημιά στον φούρνο.
 - ε. Τοποθετήστε τον φούρνο όσο το δυνατόν πιο μακριά από ραδιόφωνα και τηλεοράσεις. Η λειτουργία του φούρνου μικροκυμάτων μπορεί να προκαλέσει παρεμβολές στη ραδιοφωνική ή τηλεοπτική σας λήψη.

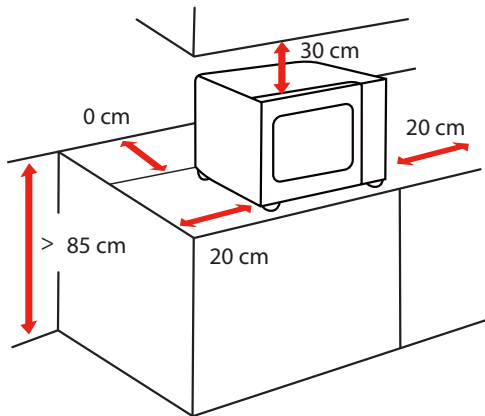

ΡΥΘΜΙΣΗ ΤΟΥ ΦΟΥΡΝΟΥ ΣΑΣ

2. Συνδέστε τον φούρνο σας σε μια τυπική οικιακή πρίζα. Βεβαιωθείτε ότι η τάση και η συχνότητα είναι ίδιες με την τάση και τη συχνότητα που αναγράφονται στην ετικέτα χαρακτηριστικών.



**ΠΡΟΕΙΔΟΠΟΙ
ΗΣΗ**

- Μην εγκαθιστάτε τον φούρνο πάνω από εστία ή άλλη συσκευή που παράγει θερμότητα. Εάν εγκατασταθεί κοντά ή πάνω από πηγή θερμότητας, ο φούρνος μπορεί να υποστεί ζημιά και η εγγύηση θα ακυρωθεί.

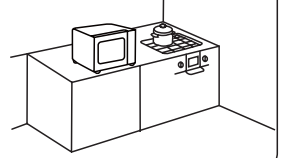

Οι επιφάνειες ζεσταίνονται πολύ κατά τη διάρκεια της χρήσης.

ΠΡΙΝ ΑΠΌ ΤΗΝ ΠΡΩΤΗ ΧΡΗΣΗ

Η συσκευή ενδέχεται να παράγει δυσάρεστες οσμές όταν χρησιμοποιείται για πρώτη φορά. Αυτή η ενότητα σας ενημερώνει για το τι πρέπει να κάνετε πριν χρησιμοποιήσετε τον φούρνο μικροκυμάτων σας για να προετοιμάσετε φαγητό για πρώτη φορά. Διαβάστε προηγουμένως την ενότητα με τίτλο «**ΣΗΜΑΝΤΙΚΕΣ ΟΔΗΓΙΕΣ ΑΣΦΑΛΕΙΑΣ**» στη σελίδα 3.

Πριν χρησιμοποιήσετε τη νέα σας συσκευή, θα πρέπει να τοποθετήσετε σωστά τον περιστρεφόμενο δίσκο στη θέση του. Πρέπει επίσης να καθαρίσετε το χώρο μαγειρέματος και τα εξαρτήματα.



ΣΗΜΕΙΩΣΗ

- Ποτέ μη χρησιμοποιείτε τη συσκευή χωρίς τον περιστρεφόμενο δίσκο.
- Βεβαιωθείτε ότι είναι σωστά συνδεδεμένος. Ο περιστρεφόμενος δίσκος μπορεί να περιστρέφεται δεξιόστροφα ή αριστερόστροφα.

ΛΕΙΤΟΥΡΓΙΑ

ΠΙΝΑΚΑΣ ΕΛΕΓΧΟΥ ΚΑΙ ΧΑΡΑΚΤΗΡΙΣΤΙΚΑ

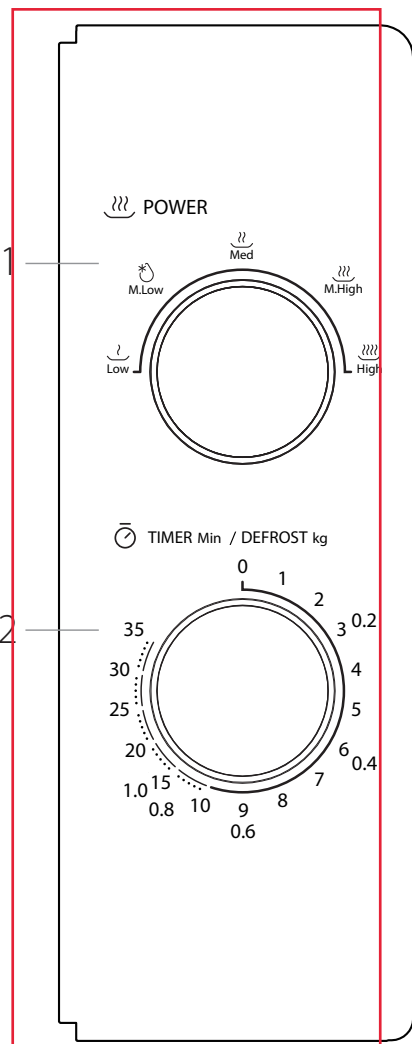

1. Διακόπτης POWER
2. Διακόπτης TIMER

1. Για να ρυθμίσετε την ισχύ μαγειρέματος, γυρίστε τον διακόπτη POWER στο επιθυμητό επίπεδο.
2. Για να ρυθμίσετε τον χρόνο μαγειρέματος, γυρίστε τον διακόπτη TIMER στον επιθυμητό χρόνο σύμφωνα με τον οδηγό μαγειρέματος τροφίμων.
3. Ο φούρνος μικροκυμάτων θα αρχίσει αυτόματα το μαγείρεμα μόλις ρυθμιστούν τα επίπεδα ισχύος και χρόνου.
4. Μόλις ολοκληρωθεί ο χρόνος μαγειρέματος, ακούγεται μία ηχητική ειδοποίηση «ντογκ» για να σταματήσει η συσκευή.
5. Εάν η συσκευή δεν χρησιμοποιείται, να ρυθμίζετε πάντα τον χρόνο στο «0».

Λειτουργία/Ισχύς	Έξοδος	Εφαρμογή
Χαμηλή	17% μικροκυμάτων	Για να μαλακώσετε παγωτό
Μεσαία Χαμηλή (ξεπάγωμα)	33% μικροκυμάτων	Για φρούτες, βραστά, για να μαλακώσετε βούτυρο ή για ξεπάγωμα
Μεσαία	55% μικροκυμάτων	Βραστά, ψάρι
Μεσαία Υψηλή	77% μικροκυμάτων	Ρύζι, ψάρι, κοτόπουλο, κιμάς
Υψηλή	100% μικροκυμάτων	Ζέσταμα φαγητού, γάλα, βράσιμο νερού, λαχανικά, ροφήματα



ΣΗΜΕΙΩΣΗ

- Κατά την αφαίρεση φαγητού από το φούρνο, βεβαιωθείτε ότι ο φούρνος είναι απενεργοποιημένος γυρίζοντας τον χρονοδιακόπτη στο 0 (μηδέν).
- Σε αντίθετη περίπτωση και σε περίπτωση λειτουργίας του φούρνου μικροκυμάτων χωρίς φαγητό στο εσωτερικό του, μπορεί να οδηγήσει σε υπερθέρμανση και ζημιά στο μάγνητρο.

ΚΑΘΑΡΙΣΜΟΣ

Με καλή φροντίδα και καθαρισμό, η συσκευή σας θα διατηρήσει την εμφάνισή της και θα παραμείνει πλήρως λειτουργική για μεγάλο χρονικό διάστημα. Θα σας εξηγήσουμε εδώ πώς πρέπει να φροντίζετε και να καθαρίζετε σωστά τη συσκευή σας.



ΠΡΟΕΙΔΟ ΠΟΙΗΣΗ

- Το γρατζουνισμένο γυαλί στην πόρτα της συσκευής μπορεί να εξελιχθεί σε ρωγμή. Μη χρησιμοποιείτε ξύστρα γυαλιού, αιχμηρά ή λειαντικά καθαριστικά βοηθήματα ή απορρυπαντικά.
- Η επιφάνεια της συσκευής μπορεί να υποστεί ζημιά αν δεν καθαριστεί σωστά. Ενέργεια μικροκυμάτων μπορεί να διαφύγει. Καθαρίζετε τη συσκευή σε τακτική βάση και απομακρύνετε αμέσως τυχόν υπολείμματα φαγητού.
- Μη βυθίζετε τη συσκευή σε νερό ή μην καθαρίζετε κάτω από πίδακα νερού.

Καθαριστικό μέσο

Για να διασφαλίσετε ότι οι διάφορες επιφάνειες δεν θα υποστούν ζημιά από τη χρήση λανθασμένου καθαριστικού μέσου, τηρείτε τις παρακάτω πληροφορίες. Πλένετε καλά τα καινούργια πανιά σφουγγαρίσματος πριν από τη χρήση.

Μη χρησιμοποιείτε:



Σκληρά ή λειαντικά
καθαριστικά



Μεταλλικές ή γυάλινες
ξύστρες για τον καθαρισμό
των πάνελ της πόρτας

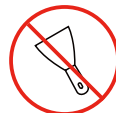

Μεταλλικές ή γυάλινες
ξύστρες για τον καθαρισμό
της στεγανοποίησης της
πόρτας



Σκληρά επιθέματα
καθαρισμού ή
σφουγγάρια



Καθαριστικά με υψηλή
περιεκτικότητα σε αλκοόλη

ΠΡΟΣΟΨΗ ΣΥΣΚΕΥΗΣ

Ζεστό σαπουνόνερο:

Καθαρίστε με ένα πανί πιάτων και στη συνέχεια στεγνώστε με ένα μαλακό πανί. Μη χρησιμοποιείτε μεταλλικές ή γυάλινες ξύστρες για τον καθαρισμό.

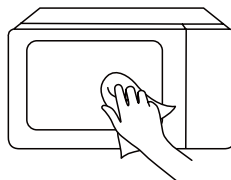

ΚΑΘΑΡΙΣΜΟΣ

ΜΠΡΟΣΤΙΝΗ ΠΛΑΚΑ ΤΗΣ ΣΥΣΚΕΥΗΣ

Ζεστό σαπουνόνερο:

Καθαρίστε με ένα πανί πιάτων και στη συνέχεια στεγνώστε με ένα μαλακό πανί.

Απομακρύνετε αμέσως τις πιτσιλιές και τις κηλίδες από άλατα, λίπη, άμυλο και λευκώματα. Κάτω από αυτούς τους λεκέδες ή τις πιτσιλιές μπορεί να σχηματιστεί διάβρωση. Μη χρησιμοποιείτε καθαριστικά γυαλιού ή μεταλλικές ή γυάλινες ξύστρες για τον καθαρισμό.

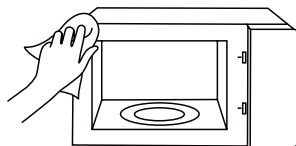

ΕΣΩΤΕΡΙΚΟ ΤΜΗΜΑ

Ζεστό σαπουνόνερο ή διάλυμα ξιδιού:

Καθαρίστε με ένα πανί πιάτων και στη συνέχεια στεγνώστε με ένα μαλακό πανί. Μη χρησιμοποιείτε σπρέι φούρνου ή άλλα επιθετικά καθαριστικά φούρνου ή λειαντικά υλικά. Ακατάλληλα είναι επίσης τα σφουγγάρια καθαρισμού, τα τραχιά σφουγγάρια και τα καθαριστικά ταψιών. Αυτά τα αντικείμενα χαράζουν την επιφάνεια. Αφήστε τις εσωτερικές επιφάνειες να στεγνώσουν εντελώς.

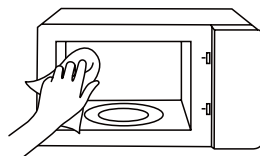

ΕΣΟΧΕΣ ΣΤΟ ΕΣΩΤΕΡΙΚΟ ΤΜΗΜΑ

Υγρό πανί:

Το νερό δεν πρέπει να εισέρχεται στη συσκευή μέσω του περιστρεφόμενου δίσκου. Στεγνώστε τον περιστρεφόμενο δίσκο με ένα πανί.

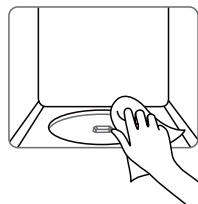

ΠΕΡΙΣΤΡΕΦΟΜΕΝΟΣ ΔΙΣΚΟΣ ΚΑΙ ΔΑΚΤΥΛΙΟΣ ΚΥΛΙΝΔΡΟΥ

Ζεστό σαπουνόνερο:

Όταν τοποθετείτε τον περιστρεφόμενο δίσκο πίσω στην εσοχή του, πρέπει να ασφαλίσει σωστά.

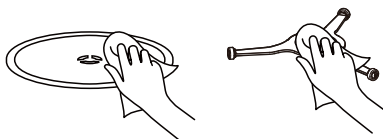

ΠΙΝΑΚΑΣ ΠΟΡΤΑΣ

Καθαριστικό γυαλιού:

Καθαρίστε με ένα πανί πιάτων. Μη χρησιμοποιείτε ξύστρες γυαλιού.

ΣΥΝΤΗΡΗΣΗ

ΑΝΤΙΜΕΤΩΠΙΣΗ ΠΡΟΒΛΗΜΑΤΩΝ

Δοκιμάστε τις λύσεις για κάθε πρόβλημα αφού χρησιμοποιήσετε τον παρακάτω πίνακα για να ελέγξετε το πρόβλημά σας. Επικοινωνήστε με την πλησιέστερη εξουσιοδοτημένη υπηρεσία σέρβις εάν ο φούρνος μικροκυμάτων εξακολουθεί να μην λειτουργεί σωστά.

ΠΡΟΒΛΗΜΑ	ΠΙΘΑΝΗ ΑΙΤΙΑ	ΠΙΘΑΝΗ ΛΥΣΗ
Ο φούρνος δεν ξεκινάει	<ul style="list-style-type: none">α. Το ηλεκτρικό καλώδιο του φούρνου δεν είναι συνδεδεμένο στην πρίζα.β. Η πόρτα είναι ανοιχτή.γ. Έχει επιλεγεί η λανθασμένη λειτουργία.	<ul style="list-style-type: none">α. Συνδέστε το στην πρίζα.β. Κλειδώστε την πόρτα και δοκιμάστε άλλη μια φορά.γ. Επαληθεύστε τις οδηγίες
Δημιουργία τόξου ή σπινθήρα	<ul style="list-style-type: none">α. Χρησιμοποιήθηκαν αντικείμενα που δεν πρέπει να χρησιμοποιούνται σε φούρνο μικροκυμάτων.β. Ο φούρνος χρησιμοποιείται όταν είναι άδειος.γ. Τρόφιμα που έχουν χυθεί παραμένουν στην κοιλότητα.	<ul style="list-style-type: none">α. Χρησιμοποιείτε μόνο μαγειρικά σκεύη που είναι ασφαλή για φούρνο μικροκυμάτων.β. Ποτέ μη χρησιμοποιείτε φούρνο που είναι άδειος.γ. Τρίψτε την κοιλότητα με μια υγρή πετσέτα.
Ανομοίμορφα μαγειρεμένα τρόφιμα	<ul style="list-style-type: none">α. Χρησιμοποιήθηκαν αντικείμενα που δεν πρέπει να χρησιμοποιούνται σε φούρνο μικροκυμάτων.β. Το φαγητό δεν έχει αποψυχθεί πλήρως.γ. Το επίπεδο ισχύος είναι ανεπαρκές για το χρόνο μαγειρέματος.δ. Το φαγητό δεν έχει περιστραφεί ή αναδευτεί.	<ul style="list-style-type: none">α. Χρησιμοποιείτε μόνο μαγειρικά σκεύη ασφαλή για φούρνο μικροκυμάτωνβ. Αποψύξτε πλήρως τα τρόφιμα.γ. Χρησιμοποιήστε την κατάλληλη ισχύ και τον κατάλληλο χρόνο μαγειρέματος.δ. Ανακατέψτε ή γυρίστε το φαγητό.
Υπερψημένα τρόφιμα	Ο χρόνος μαγειρέματος και το επίπεδο ισχύος είναι ανεπαρκή.	Χρησιμοποιήστε την κατάλληλη ισχύ και τον κατάλληλο χρόνο μαγειρέματος.
Μη καλά μαγειρεμένα τρόφιμα	<ul style="list-style-type: none">α. Χρησιμοποιήθηκαν αντικείμενα που δεν πρέπει να χρησιμοποιούνται σε φούρνο μικροκυμάτων.β. Το φαγητό δεν έχει αποψυχθεί πλήρως.γ. Οι θύρες εξαερισμού του φούρνου είναι περιορισμένες.δ. Ο χρόνος μαγειρέματος και το επίπεδο ισχύος είναι ακατάλληλα.	<ul style="list-style-type: none">α. Χρησιμοποιείτε μόνο μαγειρικά σκεύη που είναι ασφαλή για φούρνο μικροκυμάτων.β. Ξεπαγώστε πλήρως το φαγητό.γ. Βεβαιωθείτε ότι οι θύρες εξαερισμού του φούρνου δεν είναι φραγμένες.δ. Χρησιμοποιήστε τον κατάλληλο χρόνο μαγειρέματος και το κατάλληλο επίπεδο ισχύος.
Ακατάλληλη απόψυξη	<ul style="list-style-type: none">α. Χρησιμοποιήθηκαν αντικείμενα που δεν πρέπει να χρησιμοποιούνται σε φούρνο μικροκυμάτων.β. Ακατάλληλο επίπεδο ισχύος και χρόνος μαγειρέματος.γ. Δεν έγινε περιστροφή ή τρίψιμο των τροφίμων.	<ul style="list-style-type: none">α. Χρησιμοποιείτε μόνο μαγειρικά σκεύη ασφαλή για μικροκύματα.β. Χρησιμοποιήστε τον συνιστώμενο χρόνο μαγειρέματος και το συνιστώμενο επίπεδο ισχύος.γ. Αναποδογυρίστε ή γυρίστε το φαγητό.



Σύμφωνα με την οδηγία για τα απόβλητα από ηλεκτρικό και ηλεκτρονικό εξοπλισμό (ΑΗΗΕ), τα ΑΗΗΕ θα πρέπει να συλλέγονται και να απορρίπτονται ξεχωριστά. Εάν χρειαστεί να απορρίψετε αυτό το προϊόν στο μέλλον, παρακαλούμε να μην το απορρίψετε μαζί με τα οικιακά σας απορρίμματα. Παρακαλείστε να μεταφέρετε αυτό το προϊόν σε σημείο συλλογής ΑΗΗΕ, όπου υπάρχει.

#DetailsMatter

MANUAL DE INSTRUÇÕES

Forno micro-ondas

MW-MM20P(BK)/MW-MM20P(WH)

Reveja este manual de instruções antes de utilizar.

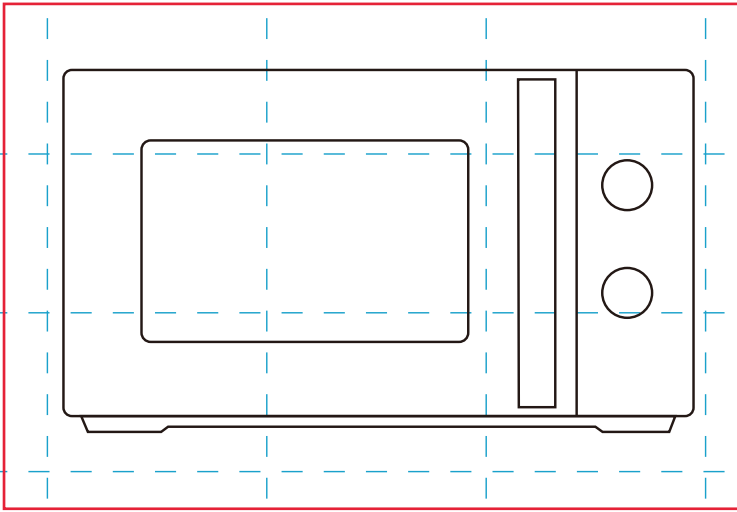

ÍNDICE

SEGURANÇA DO PRODUTO

Precauções para evitar a possível exposição à energia excessiva de micro-ondas	PT-01
Instruções de segurança importantes	PT-03
Para reduzir o risco de ferimentos em pessoas, instalação de ligação à terra	PT-07
Limpeza	PT-09
Utensílios	PT-10
Materiais que pode utilizar no forno micro-ondas	PT-11
Materiais que não pode utilizar no forno micro-ondas	PT-13

CONFIGURAÇÃO DO PRODUTO

Configurar o forno	PT-14
--------------------------	-------

INSTRUÇÕES DE UTILIZAÇÃO

Antes de usar pela primeira vez	PT-17
Utilização	PT-18
Limpeza	PT-19

RESOLUÇÃO DE PROBLEMAS

Resolução de problemas	PT-21
------------------------------	-------



NOTA

ANTES DE UTILIZAR ESTE PRODUTO, LEIA, COMPREENDA E SIGA ESTAS INSTRUÇÕES. GUARDE ESTA LISTA DE LIVROS PARA REFERÊNCIA FUTURA.

SEGURANÇA DO PRODUTO

PRECAUÇÕES PARA EVITAR A POSSÍVEL EXPOSIÇÃO À ENERGIA EXCESSIVA DE MICRO-ONDAS

(a). Não tente utilizar este forno com a porta aberta, uma vez que tal poderá resultar na exposição prejudicial a energia de micro-ondas. É importante que não parta ou adultere os bloqueios de segurança.

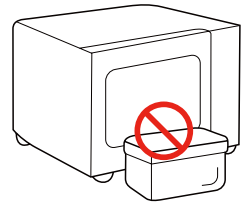

(b). Não coloque qualquer objeto entre a face frontal do forno e a porta nem deixe acumular sujidade ou resíduos de produtos de limpeza nas superfícies vedantes.

(c). **AVISO:** Se a porta ou os vedantes da porta estiverem danificados, o forno não deve ser utilizado até ser reparado por um técnico competente.

ADENDA

Se o aparelho não for mantido em bom estado de limpeza, a sua superfície pode degradar-se e afetar a vida útil do aparelho, causando uma situação perigosa.

ESPECIFICAÇÕES

MODELO	MW-MM20P(BK) MW-MM20P(WH)
TENSÃO NOMINAL/FREQUÊNCIA	230-240 V~ 50 Hz
POTÊNCIA NOMINAL DE ENTRADA (MICROONDAS)	1200 -1270 W
POTÊNCIA NOMINAL DE SAÍDA (MICROONDAS)	750 -800 W



NOTA

Se houver qualquer discrepância entre o equipamento e as imagens deste manual, o produto prevalecerá.

INSTRUÇÕES DE SEGURANÇA IMPORTANTES



AVISO

Para reduzir o risco de incêndio, choque elétrico, ferimentos pessoais ou exposição a energia excessiva do forno micro-ondas ao utilizar o aparelho, siga as precauções básicas, incluindo as seguintes:



Leia e siga a especificação: **"PRECAUÇÕES PARA EVITAR A POSSÍVEL EXPOSIÇÃO À ENERGIA EXCESSIVA DE MICRO-ONDAS"**.



O aparelho pode ser utilizado por crianças com 8 anos ou mais e pessoas com capacidades físicas, sensoriais ou mentais reduzidas, ou falta de experiência ou conhecimento, sob supervisão ou se lhes tiverem sido dadas instruções relativas à utilização do aparelho de forma segura e entenderem os perigos envolvidos. As crianças não devem brincar com o aparelho. A limpeza e a manutenção do utilizador não devem ser feitas por crianças sem supervisão.



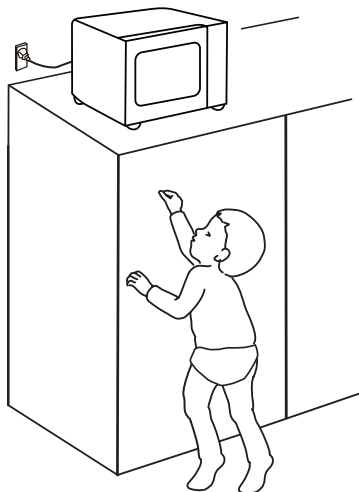

Mantenha o aparelho e o seu cabo fora do alcance de crianças com menos de 8 anos de idade.





Se o cabo de alimentação estiver danificado, o mesmo deve ser substituído pelo fabricante, respetivo agente de manutenção ou por pessoas com qualificações similares, de modo a evitar perigos.

INSTRUÇÕES DE SEGURANÇA IMPORTANTES

 **AVISO:** Certifique-se de que o aparelho está desligado antes de substituir a lâmpada para evitar a possibilidade de choque elétrico.

 **AVISO:** É perigoso para qualquer pessoa que não seja um técnico competente realizar qualquer operação de manutenção ou reparação que envolva a remoção de uma cobertura que proteja contra a exposição à energia de micro-ondas.

 **AVISO:** Não deve aquecer líquidos e outros alimentos em recipientes selados, uma vez que são suscetíveis de explodir.

 Ao aquecer alimentos em recipientes de plástico ou papel, esteja atento ao forno devido à possibilidade de ignição.



 Utilize apenas utensílios adequados para utilização em fornos micro-ondas.

 Se for emitido fumo, desligue ou retire o cabo de alimentação do aparelho e mantenha a porta fechada para inibir quaisquer chamas.

 O aquecimento de bebidas no micro-ondas pode resultar na fervura eruptiva tardia, pelo que se deve ter cuidado ao manusear o recipiente.

 Para evitar queimaduras, o conteúdo de biberões e boiões de comida para bebés deve ser mexido ou agitado e a temperatura verificada antes de ser servido.

 O forno deve ser limpo regularmente e todos os resíduos de alimentos devem ser removidos.

INSTRUÇÕES DE SEGURANÇA IMPORTANTES

Mantenha a área do guia de ondas limpa. Use um pano macio e húmido para limpá-lo quando houver resíduos de salpicos de comida na área do guia de ondas ou no compartimento de cozimento. A falha na limpeza de resíduos de alimentos pode causar faíscas inócuas ou algum fumo no interior do micro-ondas, podendo também ocorrer a sua descoloração.

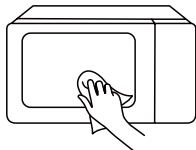

 A falta de limpeza do micro-ondas poderá provocar a deterioração da sua superfície, situação que poderá afetar o tempo de vida útil do aparelho e provocar possíveis situações perigosas.

 Utilize apenas a sonda de temperatura recomendada para este forno. (para fornos com capacidade de utilização de sonda sensível à temperatura.)

 O forno micro-ondas deve ser utilizado com a porta decorativa aberta. (para fornos com porta decorativa.)

 Este aparelho destina-se a ser utilizado em aplicações domésticas e similares, tais como:

1. áreas da copa de funcionários em lojas, escritórios e outros ambientes de trabalho;
2. por clientes em hotéis, motéis e outros ambientes residenciais;
3. casa rurais;
4. ambientes de alojamento e pequeno-almoço.

 O micro-ondas destina-se a aquecer alimentos e bebidas. A secagem de alimentos ou peças de roupa e o aquecimento de almofadas de aquecimento, pantufas, esponjas, panos húmidos e semelhantes podem causar ferimentos, a ignição destes produtos ou incêndio.

INSTRUÇÕES DE SEGURANÇA IMPORTANTES

 O aparelho destina-se a ser utilizado de forma independente.

 A superfície traseira dos aparelhos deve ficar encostada contra uma parede.

 Os ovos com casca e ovos cozidos não devem ser aquecidos em fornos micro-ondas, pois podem explodir, mesmo depois de cozinhados.

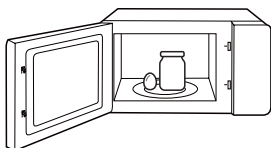

 O aparelho não deve ser instalado atrás de uma porta decorativa, de modo a evitar

sobreaquecimento.
(Isto não se aplica a aparelhos com porta decorativa.)

 O forno micro-ondas não deve ser colocado dentro de um armário, a menos que tenha sido testado num armário.

 Não é permitida a utilização de recipientes metálicos para alimentos e bebidas ao cozinhar com micro-ondas.

 O aparelho não deve ser limpo com dispositivos de limpeza a calor.

LEIA COM ATENÇÃO E GUARDE
PARA REFERÊNCIA FUTURA

PARA REDUZIR O RISCO DE FERIMENTOS EM PESSOAS, INSTALAÇÃO DE LIGAÇÃO À TERRA

Este aparelho deve ter ligação à terra. No caso de curto-circuito elétrico, a ligação à terra reduz o risco de choque elétrico através de um fio de descarga para a corrente elétrica.

Este aparelho está equipado com um cabo com ficha de ligação à terra. A ficha deve ser ligada a uma tomada corretamente instalada e com ligação à terra.

AVISO - O uso inadequado da ligação à terra pode resultar em risco de choque elétrico. Contacte um electricista ou técnico qualificado se não compreender em absoluto as indicações sobre a ligação à terra ou em caso de dúvida sobre a correta ligação à terra do aparelho.

Caso seja necessário utilizar uma extensão, utilize apenas um cabo de extensão com 3 conectores.



PERIGO

Perigo de choque elétrico:

Tocar em alguns dos componentes internos pode resultar em graves danos pessoais ou morte. Não desmonte este aparelho.

PARA REDUZIR O RISCO DE FERIMENTOS EM PESSOAS, INSTALAÇÃO DE LIGAÇÃO À TERRA



AVISO

Perigo de choque elétrico:

A utilização inadequada do sistema de ligação à terra pode originar choques elétricos. Não ligue o aparelho a uma tomada até que esteja devidamente instalado e ligado à terra.

1. O micro-ondas inclui um cabo de alimentação curto, para reduzir os riscos de o utilizador ficar preso ou tropeçar num cabo mais comprido.
2. Se for usado um cabo longo ou extensão:
 - (1). A classificação elétrica do cabo ou extensão deve ser minimamente aproximada à classificação elétrica do aparelho.
 - (2). O cabo de extensão deve ser de ligação à terra com 3 conectores.
 - (3). O cabo comprido deve ser disposto de forma que não fique pendurado sobre o balcão ou sobre a mesa, onde possa ser puxado por crianças ou no qual possa tropeçar inadvertidamente.

LIMPEZA

Desligue o aparelho da fonte de alimentação.

1. Após a utilização, limpe o compartimento do forno com um pano ligeiramente humedecido.
2. Limpe os acessórios com água com sabão pela via normal.
3. A moldura e o vedante da porta e os componentes adjacentes devem ser cuidadosamente limpos com um pano húmido quando estiverem sujos.
4. Não utilize produtos de limpeza abrasivos ou raspadores de metal afiados para limpar o vidro da porta do forno, já que podem arranhar a superfície e partir o vidro.
5. Sugestão de limpeza---Para uma limpeza facilitada das paredes do compartimento com as quais os alimentos podem entrar em contacto: Coloque meio limão numa taça, adicione 300 ml de água e aqueça à potência máxima do micro-ondas durante 10 minutos. Limpe o forno com um pano macio e seco.

UTENSÍLIOS



CUIDADO

Perigo de ferimentos pessoais:

É perigoso para qualquer pessoa que não seja um técnico competente realizar qualquer operação de manutenção ou reparação que envolva a remoção de uma cobertura que proteja contra a exposição à energia de micro-ondas. Consulte as instruções nas secções "**Materiais que pode utilizar no forno micro-ondas**" ou "**Materiais que não pode utilizar no forno micro-ondas**".

Pode não ser segura a utilização de determinados utensílios não metálicos no micro-ondas. Em caso de dúvida, pode testar o utensílio em questão seguindo o procedimento abaixo.

Teste de utensílio:

1. Encha um recipiente adequado para micro-ondas com 1 copo de água fria (250 ml) juntamente com o utensílio em questão.
2. Cozinhe na potência máxima durante 1 min.
3. Verifique cuidadosamente a temperatura do utensílio. Se o utensílio vazio estiver quente, não o utilize para cozinhar no micro-ondas.
4. Não exceda 1 minuto de tempo de cozimento.

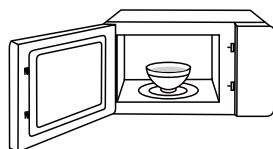

NOTA



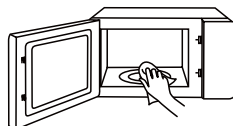



MANTENHA O COMPARTIMENTO DE COZIMENTO E A ÁREA DO GUIA DE ONDAS LIMPAS

















MATERIAIS QUE PODE UTILIZAR NO FORNO MICRO-ONDAS

UTENSÍLIOS	OBSERVAÇÕES
 <p>Prato para altas temperaturas</p>	<p>Siga as instruções do fabricante. A parte inferior do prato para altas temperaturas deve estar, pelo menos, 5 mm acima do prato giratório. O prato giratório pode partir se o utilizar incorretamente.</p> 
 <p>Loiça</p>	<p>Apenas adequada para o micro-ondas. Siga as instruções do fabricante. Não utilize pratos rachados ou lascados.</p> 
 <p>Frascos de vidro</p>	<p>Retire sempre a tampa. Utilize apenas para aquecer alimentos até que fiquem quentes. A maioria dos frascos de vidro não são resistentes ao calor e podem partir.</p> 
 <p>Objetos de vidro</p>	<p>Apenas objetos de vidro resistentes ao calor do forno. Certifique-se de que não possuem acabamentos metálicos. Não utilize pratos rachados ou lascados.</p> 
 <p>Sacos para micro-ondas</p>	<p>Siga as instruções do fabricante. Não feche com arame de metal. Faça cortes para permitir a saída de vapor.</p> 
 <p>Copos e pratos de papel</p>	<p>Utilize apenas para cozinhar/aquecer a curto prazo. Não deixe o aparelho sem vigilância durante a cozedura.</p> 
 <p>Papel de cozinha</p>	<p>Utilize para cobrir alimentos, de forma a reaquecê-los e absorver a gordura. Utilize apenas para períodos curtos de cozedura sob vigilância.</p> 
 <p>Papel vegetal</p>	<p>Utilize para cobrir, de forma a evitar salpicos, ou envolver os alimentos durante a cozedura a vapor.</p> 

MATERIAIS QUE PODE UTILIZAR NO FORNO MICRO-ONDAS

UTENSÍLIOS	OBSERVAÇÕES
 <p data-bbox="169 478 248 502">Plástico</p>	<p data-bbox="350 352 910 549">Apenas adequada para o micro-ondas. Siga as instruções do fabricante. Deve ser rotulado como "Seguro para micro-ondas". Alguns recipientes de plástico podem amolecer à medida que os alimentos no seu interior são aquecidos. "Os sacos para micro-ondas" e sacos hermeticamente fechados devem ser perfurados, conforme indicado na embalagem.</p> 
 <p data-bbox="122 689 295 713">Película aderente</p>	<p data-bbox="350 595 852 703">Apenas adequada para o micro-ondas. Utilize para cobrir alimentos durante a cozedura, de forma a protegê-los da desidratação. Não deixe que a película aderente toque nos alimentos.</p> 
 <p data-bbox="139 853 277 877">Termómetros</p>	<p data-bbox="350 791 874 842">Apenas adequada para o micro-ondas (termómetros para carne e doces).</p> 
 <p data-bbox="132 1016 288 1040">Papel encerado</p>	<p data-bbox="350 952 809 1005">Utilize para cobrir alimentos, de forma a evitar salpicos e protegê-los da desidratação.</p> 

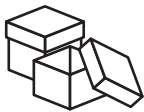
MATERIAIS QUE NÃO PODE UTILIZAR NO FORNO MICRO-ONDAS

UTENSÍLIOS	OBSERVAÇÕES	
 Recipientes de alumínio	Podem originar a formação de arco elétrico. Transfira os alimentos para um prato de utilização segura no micro-ondas.	
 Embalagens com pega de metal	Podem originar a formação de arco elétrico. Transfira os alimentos para um prato de utilização segura no micro-ondas.	
 Utensílios de metal ou com acabamentos metálicos.	O metal protege os alimentos da energia de micro-ondas. Os acabamentos metálicos podem originar a formação de arco elétrico.	
 Arames de metal	Pode causar arco elétrico e incêndio no forno.	
 Sacos de papel	Pode causar incêndio no forno.	
 Espuma plástica	A espuma plástica pode derreter ou contaminar o líquido no seu interior quando exposta a temperaturas elevadas.	
 Madeira	Quando utilizada no forno micro-ondas, a madeira irá secar e poderá lascrar ou rachar.	

CONFIGURAÇÃO DO PRODUTO

CONFIGURAR O FORNO

(Caso haja diferenças entre o aparelho e as imagens neste manual, o produto deve ser visto como a versão correta.)

NOMES DAS PEÇAS E ACESSÓRIOS DO FORNO MICRO-ONDAS

Retire o forno e todos os materiais da embalagem e do compartimento do forno.

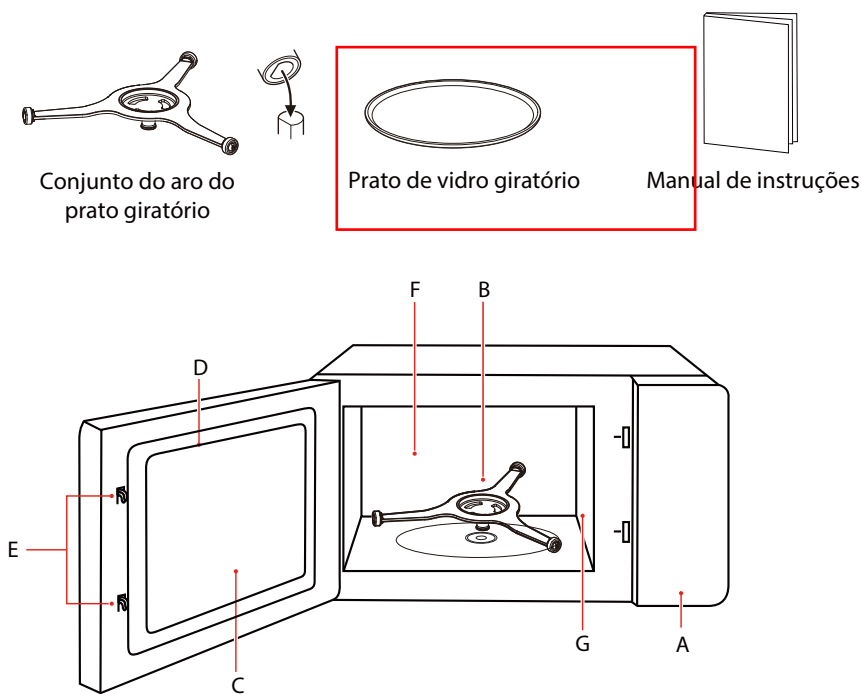

CONFIGURAR O FORNO

INSTALAÇÃO DO PRATO GIRATÓRIO

Limpe o interior do aparelho e coloque o prato giratório.

Para novas instalações, certifique-se de que toda a embalagem e fita de transporte foram removidas do eixo do prato giratório.

Antes de utilizar o aparelho para preparar alimentos pela primeira vez, será necessário colocar o prato giratório corretamente. Deve limpar o interior do aparelho e os acessórios. Também pode encaminhá-los para a secção de limpeza.

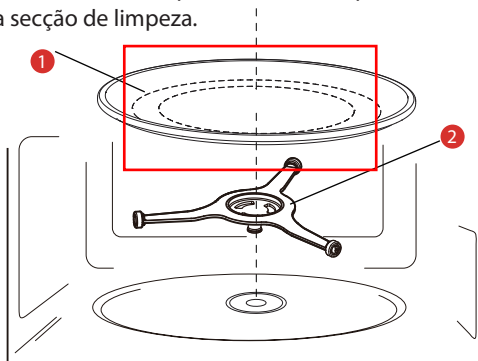

1) Bandeja de vidro

2) Conjunto do aro do prato giratório

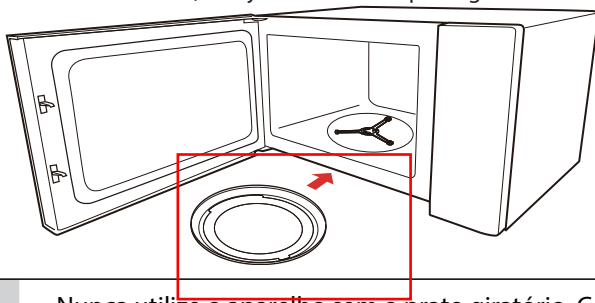

NOTA

- Nunca utilize o aparelho sem o prato giratório. Certifique-se de que esteja devidamente encaixado. O prato giratório pode girar para a esquerda ou direita.
- Nunca coloque o prato giratório de vidro virado ao contrário. O prato de vidro giratório nunca deve ser restringido.
- Tanto o prato de vidro giratório quanto o conjunto do aro do prato giratório devem ser sempre utilizados durante o cozimento.
- Todos os alimentos e recipientes são sempre colocados sobre o prato de vidro.
- Nunca restrinja o movimento do prato giratório.
- Se o prato de vidro ou o suporte do prato giratório racharem ou partirem, contacte o centro de apoio ao cliente autorizado mais próximo.

INSTALAÇÃO DO APARELHO

Remova todos os materiais de embalagem e acessórios. Examine o forno, certificando-se de que não existe qualquer dano, como amolgadelas ou porta danificada. Não instale o forno se estiver danificado.

Armário: Remova qualquer película de proteção na superfície da estrutura do forno micro-ondas. Não remova a tampa do guia de ondas que está fixada no compartimento do forno para proteger o magnetrão.

INSTALAÇÃO

- Escolha uma superfície plana que favoreça a entrada e saída de ar.
 - A altura mínima de instalação é de 85 cm.
 - A superfície traseira do aparelho deve ficar encostada contra uma parede. Deixe um espaço mínimo de 30 cm acima do forno. É necessário um espaço mínimo de 20 cm entre o forno e quaisquer paredes adjacentes.
 - Não remova as pernas da parte inferior do forno.
 - O bloqueio das aberturas de entrada e/ou saída de ar pode danificar o forno.
 - Afaste o máximo possível o forno de rádios e televisões. A utilização do forno micro-ondas poderá originar interferências a nível de receção radiofónica e televisiva.

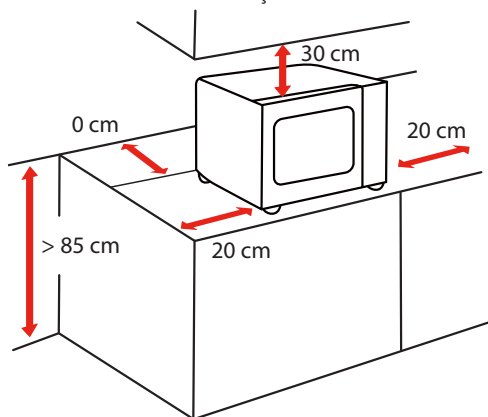

- Ligue o forno micro-ondas a uma tomada doméstica comum. Certifique-se de que os valores relativos à tensão e frequência são os mesmos valores da etiqueta de classificação.



NOTA

- Não instale o forno sobre uma placa de fogão ou outro aparelho de geração de calor. Se instalar próximo de ou sobre uma fonte de calor, o micro-ondas pode sofrer danos e a garantia ser considerada nula.

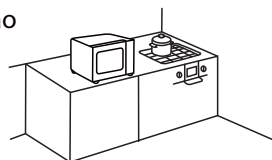

A superfície acessível pode aquecer durante a utilização

INSTRUÇÃO DE UTILIZAÇÃO

ANTES DE USAR PELA PRIMEIRA VEZ

É normal que o forno possa produzir odores desagradáveis quando for utilizado pela primeira vez.

Esta secção descreve tudo o que precisa de fazer antes de utilizar o micro-ondas para preparar alimentos pela primeira vez. Leia a secção intitulada "**INSTRUÇÕES DE SEGURANÇA IMPORTANTES**" com antecedência.

Antes de poder usar o seu novo aparelho, terá de colocar o prato giratório no lugar certo. Deve também limpar o interior do aparelho e os acessórios.



NOTA

- Nunca utilize o aparelho sem o prato giratório.
- Certifique-se de que esteja devidamente encaixado.
O prato giratório pode girar para a esquerda ou direita.

UTILIZAÇÃO

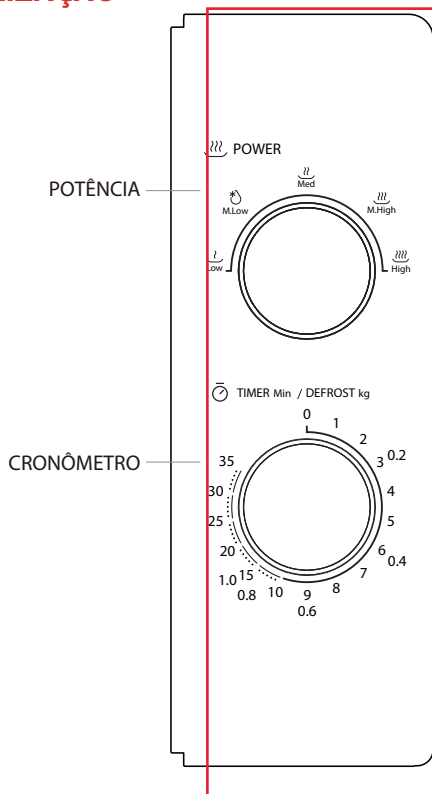

1. Para definir a potência de cozimento girando o botão de potência até o nível desejado.
2. Para definir o tempo de cozimento girando o botão do cronômetro até o tempo desejado de acordo com seu guia de cozimento de alimentos.
3. O forno micro-ondas começa a cozinhar automaticamente depois de o nível de potência e o tempo serem definidos.
4. Quando o tempo de cozimento terminar, a unidade emitirá um sinal sonoro para parar.
5. Se a unidade não estiver em uso, ajuste sempre o tempo para "0".

Função/potência	Saída	Aplicação
	17% micro.	amolecer gelado
	33% micro.	estufado de sopa, amolecer a manteiga ou descongelar
	55% micro.	estufado, peixe
	77% micro.	arroz, peixe, frango, carne picada
	100% micro.	reaquecer, leite, ferver água, legumes, bebidas



Ao retirar alimentos do forno, certifique-se de que o forno esteja desligado girando o temporizador para 0 (zero). Se não o fizer e utilizar o forno micro-ondas sem alimentos, pode resultar em sobreaquecimento e danos no magnetrão.

LIMPEZA

Com bons cuidados e limpeza, o seu aparelho manterá a sua aparência e permanecerá em pleno funcionamento por muito tempo. Explicamos aqui o que deve fazer para cuidar do seu aparelho e limpá-lo corretamente.



- O vidro riscado da porta do aparelho pode rachar. Não use raspadores de vidro, produtos de limpeza afiados ou abrasivos ou detergentes.
- A superfície do aparelho pode ficar danificada se não for limpa adequadamente. A energia das micro-ondas pode escapar. Limpe o aparelho regularmente e remova imediatamente quaisquer restos de alimentos.
- Não mergulhe o aparelho em água nem limpe com jato de água.

Agentes de limpeza

Para garantir que as diferentes superfícies não são danificadas pela utilização de um agente de limpeza errado, observe as informações na tabela. Lave cuidadosamente os panos esponja novos antes da sua utilização.

Não use:



Agentes de limpeza agressivos ou abrasivos



Raspadores de metal ou vidro para limpar os painéis da porta



Raspadores de metal ou vidro para limpar a vedação da porta



Esfregões ou esponjas duros



Agentes de limpeza com alto teor alcoólico

PARTE FRONTAL DO APARELHO

Água quente com sabão:

Limpe com um pano de pratos e depois seque com um pano macio.

Não utilize raspadores de metal ou vidro para limpar.

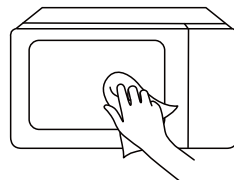

PARTE FORNTAL DO APARELHO COM AÇO INOX

Água quente com sabão:

Limpe com um pano de pratos e depois seque com um pano macio.

Remova imediatamente salpicos e manchas de calcário, gordura, amido e albumina. Pode formar-se corrosão sob essas manchas ou salpicos. Não utilize limpadores de vidro ou raspadores de metal ou vidro para a limpar.

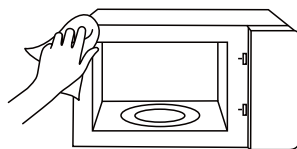

COMPARTIMENTO DE COZIMENTO EM AÇO INOXIDÁVEL

Água quente com sabão ou solução com vinagre:

Limpe com um pano de pratos e depois seque com um pano macio. Não utilize sprays de forno ou outros produtos de limpeza agressivos para forno ou materiais abrasivos. Os esfregões, esponjas ásperas e produtos de limpeza para panelas também são inadequados. Estes artigos arranham a superfície. Deixe as superfícies internas secarem completamente.

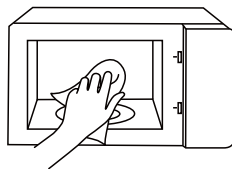

ENTALHE NO COMPARTIMENTO DE COZIMENTO

Pano húmido:

Não deve entrar água no aparelho através do acionamento do prato giratório. Seque a unidade do prato giratório com um pano.

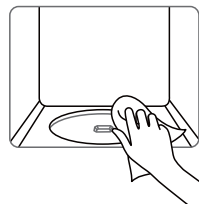

PRATO GIRATÓRIO E ARO DE ROLAMENTOS

Água quente com sabão:

Quando colocar o prato giratório de volta no entalhe, o mesmo deve encaixar corretamente.

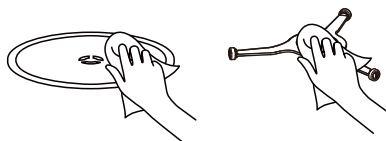

PAINÉIS DA PORTA

Limpador de vidro:

Limpe com um pano de pratos. Não use raspadores de vidro.

RESOLUÇÃO DE PROBLEMAS

Verifique o seu problema usando a tabela abaixo e experimente as soluções para cada problema. Se o forno micro-ondas ainda não funcionar corretamente, entre em contacto com o centro de serviço autorizado mais próximo.

PROBLEMA	CAUSA POSSÍVEL	SOLUÇÃO POSSÍVEL
O forno não liga	<ol style="list-style-type: none">O cabo elétrico do forno não está ligado.A porta está aberta.Foi definida uma operação errada.	<ol style="list-style-type: none">Ligue à tomada.Feche a porta e tente novamente.Verifique as instruções
Arco ou faísca	<ol style="list-style-type: none">Foram utilizados materiais a serem evitados em fornos micro-ondas.O forno funciona vazio.Alimentos derramados permanecem no compartimento.	<ol style="list-style-type: none">Use apenas utensílios adequados para micro-ondas.Não utilize com o forno vazio.Limpe o compartimento com uma toalha húmida.
Alimentos cozinhados de forma irregular	<ol style="list-style-type: none">Foram utilizados materiais a serem evitados em fornos micro-ondas.Os alimentos não foram descongelados completamente.Tempo de cozimento e nível de potência não adequados.Os alimentos não foram virados ou mexidos.	<ol style="list-style-type: none">Use apenas utensílios adequados para micro-ondas.Descongele completamente os alimentos.Use o tempo de cozimento e o nível de potência corretos.Vire ou mexa os alimentos.
Alimentos cozinhados em demasia	Tempo de cozimento e nível de potência não adequados.	Use o tempo de cozimento e o nível de potência corretos.
Alimentos mal cozinhados	<ol style="list-style-type: none">Foram utilizados materiais a serem evitados em fornos micro-ondas.Os alimentos não foram descongelados completamente.As portas de ventilação do forno estão restritas.Tempo de cozimento e nível de potência não adequados.	<ol style="list-style-type: none">Use apenas utensílios adequados para micro-ondas.Descongele completamente os alimentos.Verifique se as portas de ventilação do forno não estão restritas.Use o tempo de cozimento e o nível de potência corretos
Descongelamento inadequado	<ol style="list-style-type: none">Foram utilizados materiais a serem evitados em fornos micro-ondas.Tempo de cozimento e nível de potência não adequados.Os alimentos não foram virados ou mexidos.	<ol style="list-style-type: none">Use apenas utensílios adequados para micro-ondas.Use o tempo de cozimento e o nível de potência corretos.Vire ou mexa os alimentos.



De acordo com a diretiva relativa à eliminação de resíduos de equipamentos elétricos e eletrónicos (REEE), estes resíduos devem ser recolhidos e tratados separadamente. Se, em algum momento futuro, precisar de eliminar este produto, NÃO o faça juntamente com o lixo doméstico. Envie este produto para pontos de recolha de REEE, quando disponíveis.

#DetailsMatter

 UPUTSTVO ZA UPOTREBU

MIKROTALASNA RERNA

MW-MM20P(BK)/MW-MM20P(WH)

Pregledajte ovo uputstvo za upotrebu pre upotrebe.

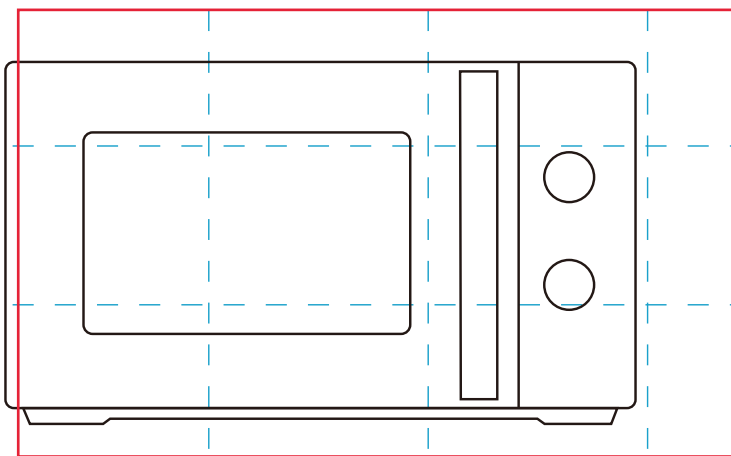

 **TOSHIBA**

SADRŽAJ

BEZBEDNOST PROIZVODA

Mere predostrožnosti za izbegavanje mogućeg izlaganja prekomernoj mikrotalasnoj energiji	SR-01
Važna bezbednosna uputstva	SR-03
Da bi se smanjio rizik od povreda osoba koje uzemljaju instalaciju	SR-08
Čišćenje	SR-10
Posuđe	SR-11
Materijali koje možete da koristite u mikrotalasnoj rerni	SR-12
Materijali koji se ne mogu koristiti u mikrotalasnoj rerni	SR-14

PODEŠAVANJE PROIZVODA

Postavljanje rerne	SR-15
--------------------------	-------

UPUTSTVO ZA KORIŠĆENJE

Pre prve upotrebe	SR-19
Rad	SR-20
Čišćenje	SR-22

ODRŽAVANJE

Rešavanje problema	SR-24
--------------------------	-------



NAPOMENA

PRE UPOTREBE OVOG PROIZVODA, PROČITAJTE, SHVATITE I SLEDITE OVA UPUTSTVA. OBAVEZNO SAČUVAJTE OVU KNJIŽICU ZA BUDUĆU UPOTREBU.

BEZBEDNOST PROIZVODA

MERE PREDOSTROŽNOSTI ZA IZBEGAVANJE MOGUĆEG IZLAGANJA PREKOMERNOJ MIKROTALASNOJ ENERGIJI

- (a). Ne pokušavajte da koristite ovu rernu sa otvorenim vratima jer to može dovesti do štetnog izlaganja mikrotalasnoj energiji. Važno je da ne lomite ili neovlašćeno rukujete sigurnosnim blokadama.
- (b). Ne stavljajte nikakav predmet između prednje strane rerne i vrata i ne dozvolite da se prljavština ili ostaci sredstva za čišćenje nakupe na zaptivnim površinama.
- (c). **UPOZORENJE:** Ako su vrata ili zaptivke vrata oštećeni, rerna se ne sme koristiti dok je ne popravi stručno lice.

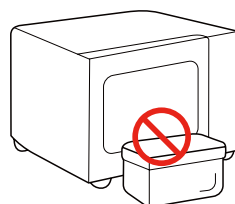

DODATAK

Ako se aparat ne održava čistim, to može da utiče na njegovu površinu i radni vek, i dovesti do opasne situacije.

SPECIFIKACIJE

MODEL	MW-MM20P(BK)/MW-MM20P(WH)
NOMINALNI NAPON/FREKVENCIJA	230-240V~ 50 Hz
NAZIVNA ULAZNA SNAGA (MIKROTALASI)	1200-1270 W
NAZIVNA IZLAZNA SNAGA (MIKROTALASI)	750-800 W



NAPOMENA

Sve slike u ovom uputstvu služe samo u ilustrativne svrhe; one se mogu malo razlikovati od kupljene opreme, pogledajte stvarni proizvod.

VAŽNA BEZBEDNOSNA UPUTSTVA



UPOZO- RENJE

Da bi se smanjio rizik od požara, strujnog udara, povrede ili izlaganja prekomernoj energiji mikrotalasne rerne prilikom njenog korišćenja, sledite osnovne mere predostrožnosti koje uključuju sledeće:



Pročitajte i pratite sledeće:

**„MERE
PREDOSTROŽNOSTI ZA
IZBEGAVANJE MOGUĆEG
IZLAGANJA
PREKOMERNOJ
MIKROTALASNOJ
ENERGIJI“.**



Deca od 8 godina i starija, kao i osobe sa smanjenim fizičkim, čulnim ili mentalnim sposobnostima ili bez dovoljnog iskustva i znanja mogu da koriste ovaj uređaj samo ako su pod nadzorom ili su im data uputstva u vezi sa korišćenjem uređaja na bezbedan način i ako razumeju opasnosti koje pri tome postoje. Deca se ne smeju igrati uređajem. Čišćenje i korisničko

održavanje ne smeju da obavljaju deca, osim ako su starija od 8 godina i pod nadzorom.



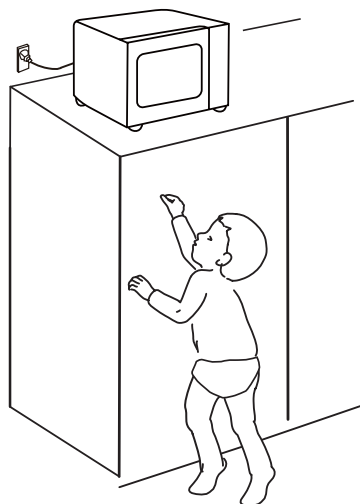

Držite aparat i kabl van domašaja dece mlađe od 8 godina.





VAŽNA BEZBEDNOSNA UPUTSTVA

 Ako je kabl za napajanje oštećen, mora da ga zameni proizvođač, njegov servisni zastupnik ili slična kvalifikovana osoba, da bi se izbegla opasnost.

 **UPOZORENJE:** Obavezno isključite aparat pre zamene sijalice u rerni zbog opasnosti od strujnog udara.

 **UPOZORENJE:** Servisiranje ili popravljanje koje uključuje uklanjanje poklopca koji štiti od izlaganja mikrotalasnoj energiji, opasno je za svakog osim za stručno lice.

 **UPOZORENJE:** Tečnosti i druga hrana ne smeju da se zagrevaju u zatvorenim posudama jer mogu da eksplodiraju.

 Prilikom zagrevanja hrane u plastičnim ili papirnim posudama, pazite na rernu zbog mogućnosti paljenja.



 Koristite samo posuđe koje je pogodno za upotrebu u mikrotalasnim rernama.

 Ako primetite dim, ugasisite ili isključite aparat iz struje, držite zatvorena vrata rerne kako bi se vatra ugasila.

 Mikrotalasno zagrevanje napitaka može dovesti do odloženog eruptivnog ključanja, stoga se mora voditi računa prilikom rukovanja posudom.

 Sadržaj bočica za hranjenje i tegli za hranu za bebe treba mešati ili protresti i proveriti njegovu

VAŽNA BEZBEDNOSNA UPUTSTVA

temperaturu pre konzumiranja, kako bi se izbegle opekotine.

 Rernu treba redovno čistiti i ukloniti sve naslage hrane. Područje talasovoda treba da bude čisto. Koristite meku vlažnu krpnu da biste je očistili kada postoje ostaci prskanja hrane na području talasovoda ili u unutrašnjosti. Ako ne očistite ostatke hrane, može doći do bezopasnog iskrenja ili pojave dima u unutrašnjosti mikrotalasne rerne, a može doći i do promene boje šupljine.

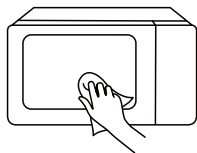

 Neodržavanje rerne čistom može dovesti do propadanja površine što može skratiti njen životni

vek upotrebe i eventualno dovesti do opasne situacije.

 Koristite samo temperaturnu sondu preporučenu za ovu pećnicu. (za rerne opremljene instalacijom za korišćenje sonde za proveru temperature.)

 Kada se koristi mikrotalasna rerna, dekorativna vrata moraju da budu otvorena. (za rerne sa dekorativnim vratima.)

 Ovaj uređaj je predviđen za korišćenje u domaćinstvu i ostalim sl. okruženjima poput:

1. kuhinje za osoblje u prodavnicama, kancelarijama i drugim radnim okruženjima;
2. hotela, motela i ostalih stambenih okruženja;
3. seoske kuće;
4. pansioni.

VAŽNA BEZBEDNOSNA UPUTSTVA

 Mikrotalasna rerna je namenjena za zagrevanje hrane i napitaka. Sušenje hrane ili odeće i zagrevanje grejnih jastučića, papuča, suđera, vlažne krpe i sličnih predmeta može dovesti do rizika od povreda, paljenja ili požara.

 Uređaj treba da stoji samostalno.

 Zadnja površina aparata se postavlja uz zid.

 Temperatura dostupnih površina može biti visoka kada aparat radi.

 **UPOZORENJE:** Kada aparat radi u kombinovanom režimu, deca smeju da koriste rernu samo pod

nadzorom odrasle osobe zbog stvorene temperature.

 Jaja u ljusci i cela tvrdo kuvana jaja ne treba zagrevati u mikrotalasnoj rerni jer mogu da eksplodiraju, čak i nakon završetka zagrevanja u mikrotalasnoj rerni.

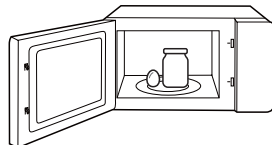



 Uređaj se ne sme postaviti iza dekorativnih vrata kako bi se izbeglo pregrevanje. (Ovo se ne odnosi na uređaje sa dekorativnim vratima.)

 Mikrotalasna rerna se ne sme stavljati u kuhinjski element osim ako nije testirana za to.

VAŽNA BEZBEDNOSNA UPUTSTVA

 Metalne posude za hranu i napitke nisu dozvoljene tokom kuvanja u mikrotalasnoj rerni.

 Aparat se ne sme čistiti parnim čistačem.

 Nije predviđeno da se aparatima upravlja pomoću spoljnog tajmera ili posebnog sistema daljinskog upravljanja.

PAŽLJIVO PROČITAJTE I SAČUVAJTE
ZA BUDUĆU UPOTREBU

DA BI SE SMANJIO RIZIK OD POVREDA OSOBA KOJE UZEMLJUJU INSTALACIJU

Ovaj aparat mora da bude uzemljen. U slučaju kratkog spoja, uzemljenje smanjuje rizik od strujnog udara putem odvodne žice za električnu struju.

Ovaj aparat je opremljen strujnim kablom i utikačem sa kontaktom za uzemljenje. Utikač mora da se priključi u utičnicu koja je pravilno instalirana i uzemljena.

UPOZORENJE - Nepravilna upotreba uzemljenja može da dovede do rizika od strujnog udara. Konsultujte se sa kvalifikovanim električarem ili serviserom ako u potpunosti ne razumete uputstva za uzemljenje ili ako niste sigurni da li je aparat pravilno uzemljen.

Ako je potrebno da se koristi produžni kabl, koristite isključivo produžni kabl sa tri žice.



OPASNOST

Opasnost od strujnog udara:

Dodirivanje nekih unutrašnjih komponenti može da dovede do ozbiljne fizičke povrede ili smrti.

Nemojte rastavljati ovaj aparata.

DA BI SE SMANJIO RIZIK OD POVREDA OSOBA KOJE UZEMLJUJU INSTALACIJU



**UPOZO-
RENJE**

Opasnost od strujnog udara:

Neispravno uzemljenje može da dovde do strujnog udara. Nemojte uključivati aparat u utičnicu dok nije pravilno instaliran i uzemljen.

1. Obezbeđen je kratak kabl za napajanje kako bi se smanjili rizici koji nastaju usled uplitanja ili spoticanja o duži kabl.
2. Ako se koristi dugačak kabl ili produžni kabl:
 - (1). Nominalna snaga strujnog kabla ili produžnog kabla mora biti jednaka ili veća od nominalne snage aparata.
 - (2). Produžni kabl mora da bude trožični kabl za uzemljenje.
 - (3). Duži kabl treba da se sprovede tako da ne visi preko radne površine ili stola gde deca mogu da ga povuku ili neko može slučajno da se saplete o njega.

ČIŠĆENJE

Obavezno isključite aparat iz napajanja.

1. Nakon upotrebe očistite unutrašnjost rerne blago vlažnom krpom.
2. Dodatke očistite na uobičajen način u vodi sa sapunicom.
3. Kada su prljavi, okvir vrata, zaptivku i okolni delovi moraju se pažljivo očistiti vlažnom krpom.
4. Ne koristite gruba, abrazivna sredstva za čišćenje i oštre metalne strugače za čišćenje stakla na vratima pećnice, jer mogu da ogrebu površinu, što može da izazove razbijanje stakla.
5. Savet za čišćenje--- Za lakše čišćenje zidova unutrašnjosti koje kuvana hrana može da dodirne: Stavite pola limuna u posudu, dodajte 300 ml vode i zagrevajte na 100% snage mikrotalasa na 10 minuta. Obrišite rernu mekom, suvom krpom.

POSUĐE



OPREZ

Opasnost od fizičke povrede:

Servisiranje ili popravljanje koje uključuje uklanjanje poklopca koji štiti od izlaganja mikrotalasnoj energiji, opasno je za svakog osim za stručno lice. Pogledajte uputstva o „ **Materijali koje možete da koristite u mikrotalasnoj rerni** “ ili „ **Materijali koji se ne mogu koristiti u mikrotalasnoj rerni** “

Postoji određeno nemetalno posuđe koje nije bezbedno za upotrebu u mikrotalasnoj rerni. Ako niste sigurni, možete testirati tu posudu prateći postupak u nastavku.

Test posuđa:

1. Napunite posudu bezbednu za upotrebu u mikrotalasnoj rerni 1 šoljicom hladne vode (250 ml), zajedno sa posudom koju proveravate.
2. Kuvajte na maksimalnoj snazi 1 minut.
3. Pažljivo opipajte posudu. Ako je prazna posuda topla, nemojte je koristiti za kuvanje u mikrotalasnoj rerni.
4. Ne prekoračujte 1 minut kuvanja.

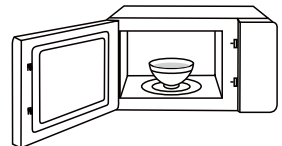





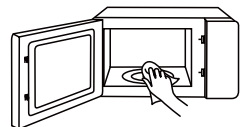











NAPOMENA

ODRŽAVAJTE UNUTRAŠNJOST I
PODRUČJE TALASOVODA ČISTIM



MATERIJALI KOJE MOŽETE DA KORISTITE U MIKROTALASNOJ RERNI

POSUĐE	NAPOMENE	
 Posuda koja služi da se u njoj zapeče jelo	Pratite uputstva proizvođača. Dno posude za pečenje mora da bude najmanje 5 mm iznad rotirajućeg tanjira. Nepravilna upotreba može dovesti do pucanja rotirajućeg tanjira.	
 Pribor za jelo	Isključivo onaj koji je pogodan za upotrebu u mikrotalasnim rernama. Pratite uputstva proizvođača. Nemojte koristiti naprslo ili okrnjeno posuđe.	
 Staklene tegle	Uvek uklonite poklopac. Koristite za zagrevanje hrane dok ne bude topla. Većina staklenih tegli nije otporna na toplotu i mogu da puknu.	
 Stakleno posuđe	Koristite isključivo vatrostalno stakleno posuđe. Na posudama nikako ne sme biti metalnih rubova. Nemojte koristiti naprslo ili okrnjeno posuđe.	
 Kese za kuvanje u rerni	Pratite uputstva proizvođača. Ne zatvarajte metalnom vezicom. Napravite proreze kako bi para mogla da izlazi.	
 Papirni tanjiri i šolje	Koristite samo za kratkotrajno kuvanje/zagrevanje. Ne ostavljajte rernu bez nadzora tokom kuvanja.	
 Papirni ubrusi	Koristite za prekrivanje hrane za podgrevanje i upijanje masnoće. Koristite uz nadzor isključivo za kratkotrajno kuvanje.	
 Papir za kolače	Koristite kao poklopac kako biste sprečili prskanje ili kao omot za kuvanje u pari.	

MATERIJALI KOJE MOŽETE DA KORISTITE U MIKROTALASNOJ RERNI

POSUĐE

NAPOMENE



Plastika

Isključivo onaj koji je pogodan za upotrebu u mikrotalasnim rernama. Pratite uputstva proizvođača. Treba da bude označeno sa „Microwave Safe“. Neke plastične posude omekšaju dok se hrana u njima podgreva. „Kese za kuvanje“ i čvrsto zatvorene plastične kese treba da se prorežu, probuše ili ostave otvorenim prema uputstvu na pakovanju.



Plastična folija

Isključivo onaj koji je pogodan za upotrebu u mikrotalasnim rernama. Koristite za prekrivanje hrane tokom kuvanja radi zadržavanja vlage. Plastična folija ne bi trebalo da dodiruje hranu.

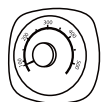

Termometri

Isključivo onaj koji je pogodan za upotrebu u mikrotalasnim rernama (termometri za meso i kolače).











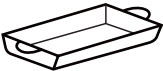



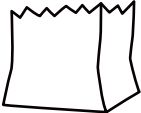

Voštani papir

Koristite kao poklopac kako biste sprečili prskanje i zadržali vlagu.

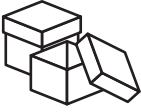

MATERIJALI KOJI SE NE MOGU KORISTITI U MIKROTALASNOJ RERNI

POSUDE	NAPOMENE	
 Aluminijumska posuda	Može da izazove varničenje. Prebacite hranu u posudu bezbednu za mikrotalasnu rernu.	
 Posude za hranu sa metalnom drškom	Može da izazove varničenje. Prebacite hranu u posudu bezbednu za mikrotalasnu rernu.	
 Metalne posude ili posude sa metalnom ivicom	Metal štiti hranu od mikrotalasne energije. Metalne ivice mogu da izazovu varničenje.	
 Metalne vezice	Mogu da izazovu varničenje i vatru unutar rerne.	
 Papirnate kese	Može da izazove vatru unutar rerne.	
 Stiropor	Stiropor može da se otopi ili kontaminira tečnost unutar rerne kada je izložen visokoj temperaturi.	
 Drvo	Drvo će se osušiti kada se koristi u mikrotalasnoj rerni i može da se rascepi ili naprsne.	

PODEŠAVANJE PROIZVODA

POSTAVLJANJE RERNE

NAZIVI DELOVA I PRIBORA ZA MIKROTALASNU RERNU

Izvadite rernu i sve materijale iz ambalaže i unutrašnjosti rerne.



Sklop prstena obrtnog postolja

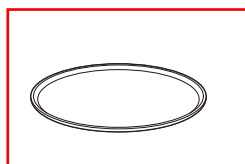

Staklena tacna



Uputstva za upotrebu

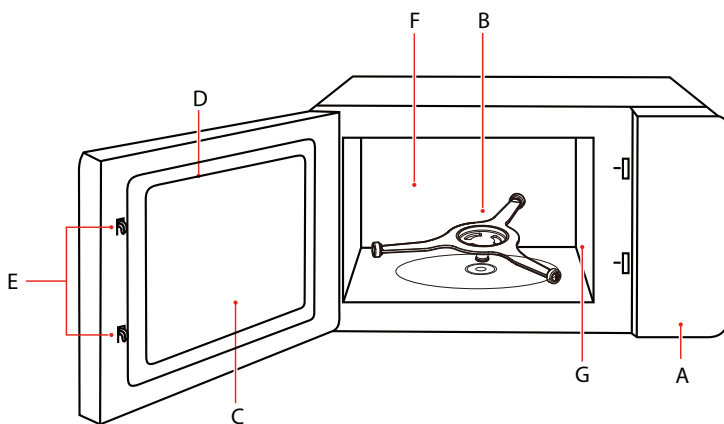

- A) Kontrolna tabla
- B) Nosač tanjira
- C) Okno za posmatranje
- D) Sklop vrata

- E) Sistem sigurnosne brave
- F) Zid pećnice
- G) Poklopac talasovoda

POSTAVLJANJE RERNE

INSTALACIJA ROTIRAJUĆEG TANJIRA

Čišćenje odeljka za kuvanje i postavljanje rotirajućeg tanjira na mesto.

Za nove instalacije, uverite se da je sva ambalaža i sigurnosna traka uklonjen sa osovine rotirajućeg tanjira.

Pre prve upotrebe uređaja za pripremu hrane, moraće pravilno da postavite rotirajući tanjir. Morate očistiti odeljak za kuvanje i pribor.

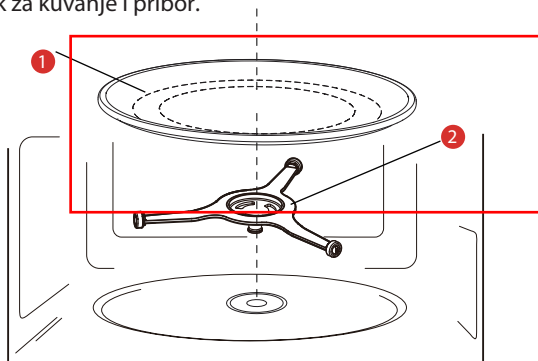

1) Staklena tacna

2) Sklop prstena obrtnog postolja

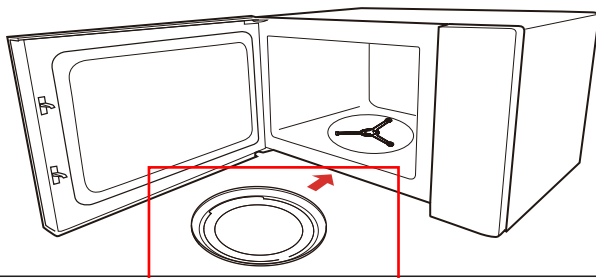

NAPOMENA

- Nikada ne koristite aparat bez rotirajućeg tanjira. Proverite da li je pravilno postavljen. Rotirajuća ploča može da se okreće u smeru kazaljke na satu ili u suprotnom.
- Staklenu tacnu nikada ne stavljajte naopako. Ništa ne sme da blokira staklenu tacnu.
- I stakleni tanjir i sklop rotirajućeg prstena uvek moraju da se koriste tokom kuvanja.
- Sva hrana i posude za hranu se uvek stavljaju na staklenu tacnu za kuvanje.
- Nikada ne ograničavajte kretanje rotirajućeg tanjira.
- Ako staklena tacna ili obruč s tokčićima pukne ili se slomi, obratite se najbližem ovlašćenom servisu.
- Ovo uputstvo za upotrebu je takođe dostupno na sledećem veb-sajtu: <http://www.manualtek.wordpress.com/>

POSTAVLJANJE RERNE

INSTALACIJA NA RADNU POVRŠINU

Uklonite sav ambalažni materijal i dodatke. Proverite da li ima oštećenja na rerni, poput ogrebotina ili polomljenih vrata. Nemojte instalirati rernu ako je oštećena.

Kućište: Uklonite svu zaštitnu foliju sa površine kućišta mikrotalasne rerne. Nemojte uklanjati poklopac talasovoda koji je pričvršćen za unutrašnjost rerne kako biste zaštitili magnetron.

INSTALACIJA

1. Izaberite ravnu površinu sa dovoljno slobodnog prostora za dovod/odvod ventilacionog sistema rerne.
 - a. Minimalna visina ugradnje je 85 cm.
 - b. Zadnja površina aparata se postavlja uz zid. Ostavite minimalni slobodni prostor od 30 cm iznad rerne. Potreban je minimalni razmak od 20 cm između rerne i bilo kojih susednih zidova.
 - c. Ne uklanjajte nožice sa dna rerne.
 - d. Blokiranje ulaza i/ili izlaza za vazduh može oštetiti rernu.
 - e. Postavite rernu što je dalje moguće od radija i televizora.
Rad mikrotalasne rerne može da izazove smetnje u prijemu radija ili televizora.

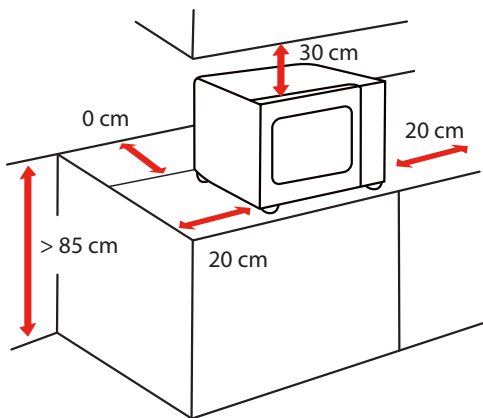

POSTAVLJANJE RERNE

2. Uključite rernu u standardnu kućnu utičnicu. Uverite se da su napon i frekvencija isti kao napon i frekvencija na nazivnoj oznaci.



- Ne postavljajte rernu na ploču za kuvanje ili drugi uređaj koji proizvodi toplotu. Ako se instalira u blizini ili iznad izvora toplote, rerna se može oštetiti i garancija se time poništava.

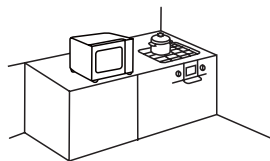

Dostupna površina može biti
vruća tokom rada.

UPUTSTVO ZA KORIŠĆENJE

PRE PRVE UPOTREBE

Uređaj može da proizvede neprijatne mirise kada se prvi put koristi.

U ovom odeljku ćete saznati šta treba da uradite pre prve upotrebe mikrotalasne rerne za pripremu hrane. Prethodno pročitajte odeljak pod nazivom „**VAŽNA BEZBEDNOSNA UPUTSTVA**“ na strani 3.

Da biste mogli da koristite svoj novi aparat, morate pravilno da postavite rotirajući tanjir. Takođe morate da očistite odeljak za kuvanje i pribor.



NAPOMENA



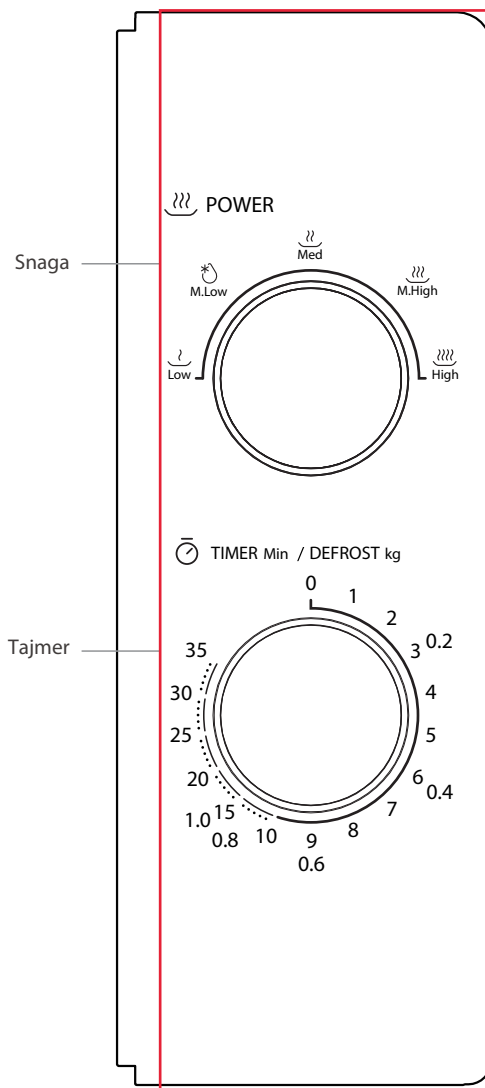

- Nikada ne koristite aparat bez rotirajućeg tanjira.
- Proverite da li je pravilno postavljen. Rotirajuća ploča može da se okreće u smeru kazaljke na satu ili u suprotnom.

RAD

KONTROLNA TABLA I FUNKCIJE



1. Za podešavanje snage kuvanja okrenite dugme za napajanje na željeni nivo.
2. Podesite vreme kuvanja okretanjem dugmeta tajmera na željeno vreme prema vašem uputstvu za kuvanje hrane.
3. Mikrotalasna rerna će automatski početi da kuva nakon podešavanja nivoa snage i vremena.
4. Kada vreme kuvanja istekne, jedinica će se oglasiti tonom "Dong" koji označava zaustavljanje.
5. Ako se jedinica ne koristi, uvek podesite vreme na početnu poziciju.

FUNKCIJA/SNAGA	IZLAZ	APLIKACIJA
	17% mikro.	Topljenje sladoleda
	33% mikro.	Supa čorba, topljenje putera ili odmrzavanje
	55% mikro.	Paprikaš, riba
	77% mikro.	Pirinač, riba, piletina, mleveno meso
	100% mikro.	Zagrejati, mleko, prokuvati vodu, povrće, piće



Napomena

- Kada vadite hranu iz rerne, uverite se da je napajanje rerne isključeno okretanjem prekidača tajmera na 0 (nula).
U suprotnom, korišćenje mikrotalasne rerne bez hrane može dovesti do pregrevanja i oštećenja magnetrona.

ČIŠĆENJE

Uz dobru negu i čišćenje, vaš aparat će zadržati svoj izgled i ostati u potpunosti funkcionalan još dugo vremena. Ovdje ćemo objasniti kako treba pravilno da održavate i čistite svoj aparat.



- Ogrebano staklo na vratima aparata može da dovede do pojave pukotine. Nemojte koristiti strugač za staklo, oštra ili abrazivna sredstva za čišćenje ili deterdžente.
- Površina aparata može se oštetiti ako nije pravilno očišćena. Energija mikrotalasa može da izađe.
- Redovno čistite aparat i odmah uklonite ostatke hrane.
- Ne potapajte aparat u vodu niti ga čistite pod mlazom vode.

Sredstvo za čišćenje

Kako se različite površine ne bi oštetile korišćenjem pogrešnog sredstva za čišćenje, pridržavajte se informacija u nastavku. Temeljno operite nove sunđeraste krpe pre upotrebe.

Nemojte koristiti:



Gruba ili abrazivna sredstva za čišćenje



Metalne strugače ili strugače za staklo za čišćenje panela vrata

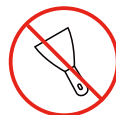

Metalni strugači ili strugači za staklo za čišćenje zaptivke vrata



Tvrđi jastučići za ribanje ili sunđeri



Sredstva za čišćenje sa visokim sadržajem alkohola

PREDNJA STRANA APARATA

Vruća voda sa sapunicom:

Očistite krpom za posuđe, a zatim osušite mekom krpom. Nemojte koristiti metalne strugače ili strugače za staklo za čišćenje.

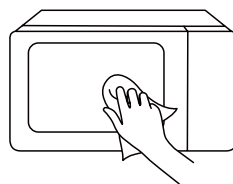

ČIŠĆENJE

PREDNJI PANEL APARATA

Vruća voda sa sapunicom:

Očistite krpom za posuđe, a zatim osušite mekom krpom. Odmah uklonite prskanja i mrlje od kamenca, masti, skroba i albumina. Može doći do pojave korozije ispod ovih mrlja ili prskanja. Za čišćenje nemojte koristiti sredstva za čišćenje stakla ili metalne strugače ili strugače za staklo.

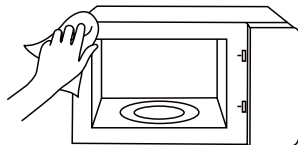

UNUTRAŠNJOST APARATA

Vruća voda sa sapunicom ili rastvor sa sirćetom:

Očistite krpom za posuđe, a zatim osušite mekom krpom. Nemojte koristiti sprej za rernu ili bilo koja druga agresivna sredstva za čišćenje rerne ili abrazivne materijale. Jastučići za ribanje, grubi sunđeri i sredstva za čišćenje tiganja takođe nisu pogodni. Ovi predmeti grebu površinu. Ostavite da se unutrašnje površine potpuno osuše.

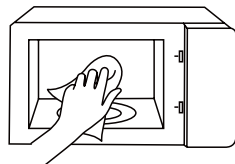

UDUBLJENJE U ODELJKU ZA KUVANJE

Vlažna krpa:

Voda ne sme da ulazi u aparat kroz pogon rotirajućeg tanjira. Osušite pogon rotirajućeg tanjira krpom.

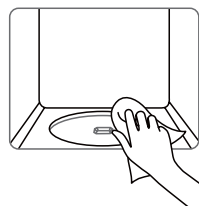

ROTIRAJUĆI TANJIR I ROTIRAJUĆI PRSTEN

Vruća voda sa sapunicom:

Prilikom vraćanja rotirajućeg tanjira u svoje udubljenje, ona mora pravilno da se pričvrsti.



PANEL VRATA

Sredstvo za čišćenje stakla:

Očistite krpom za posuđe. Nemojte koristiti strugače za staklo.

ODRŽAVANJE REŠAVANJE PROBLEMA

Potražite problem u grafikonu u nastavku i isprobajte rešenja za svaki problem.
Ako mikrotalasna rerna i dalje ne radi ispravno, obratite se najbližem ovlašćenom servisu.

PROBLEM	MOGUĆI UZROK	MOGUĆE REŠENJE
Rerna neće da se upali	<ul style="list-style-type: none">a. Električni kabl za rernu nije uključen.b. Vrata su otvorena.c. Podešena je pogrešna radna funkcija.	<ul style="list-style-type: none">a. Priključite u utičnicu.b. Zatvorite vrata i pokušajte ponovo.c. Proverite uputstva
Varničenje ili iskrenje	<ul style="list-style-type: none">a. Korišćeni su materijali koje treba izbegavati u mikrotalasnoj rerni.b. Rerna je uključena da radi dok je bila prazna.c. Prolivena hrana je ostala u unutrašnjosti.	<ul style="list-style-type: none">a. Koristite samo posuđe bezbedno za mikrotalasnu rernu.b. Nemojte uključivati rernu da radi kada je prazna.c. Očistite šupljinu mekom vlažnom krpom.
Neravnomerno kuvana hrana	<ul style="list-style-type: none">a. Korišćeni su materijali koje treba izbegavati u mikrotalasnoj rerni.b. Hrana nije potpuno odmrznuta.c. Vreme kuvanja, nivo snage nisu odgovarajući.d. Hrana se ne okreće niti meša.	<ul style="list-style-type: none">a. Koristite samo posuđe bezbedno za mikrotalasnu rernu.b. Potpuno odmrznite hranu.c. Koristite ispravno vreme kuvanja, nivo snage.d. Okrenite ili promešajte hranu.
Prekuvana hrana	Vreme kuvanja, nivo snage nisu odgovarajući.	Koristite ispravno vreme kuvanja, nivo snage.
Nedovoljno kuvana hrana	<ul style="list-style-type: none">a. Korišćeni su materijali koje treba izbegavati u mikrotalasnoj rerni.b. Hrana nije potpuno odmrznuta.c. Ventilacioni otvori rerne su blokirani.d. Vreme kuvanja, nivo snage nisu odgovarajući.	<ul style="list-style-type: none">a. Koristite samo posuđe bezbedno za mikrotalasnu rernu.b. Potpuno odmrznite hranu.c. Proverite da li otvori za ventilaciju rerne nisu blokirani.d. Koristite ispravno vreme trajanja kuvanja, nivo snage
Nepravilno odmrzavanje	<ul style="list-style-type: none">a. Korišćeni su materijali koje treba izbegavati u mikrotalasnoj rerni.b. Vreme kuvanja, nivo snage nisu odgovarajući.c. Hrana se ne okreće niti meša.	<ul style="list-style-type: none">a. Koristite samo posuđe bezbedno za mikrotalasnu rernu.b. Koristite ispravno vreme kuvanja, nivo snage.c. Okrenite ili promešajte hranu.



Prema Direktivi o otpadnoj električnoj i elektronskoj opremi (WEEE), WEEE treba odvojeno prikupljati i obrađivati. Ako u bilo kom trenutku u budućnosti budete morali da odložite ovaj proizvod, nemojte ga odlagati sa kućnim otpadom. Pošaljite ovaj proizvod na mesta za sakupljanje WEEE, gde je to dostupno.

#DetailsMatter

РЪКОВОДСТВО ЗА ЕКСПЛОАТАЦИЯ

МИКРОВОЪЛНОВА ФУРНА

MW-MM20P(BK)/MW-MM20P(WH)

Моля, прочетете настоящото ръководство за експлоатация преди да пристъпите към работа с уреда.

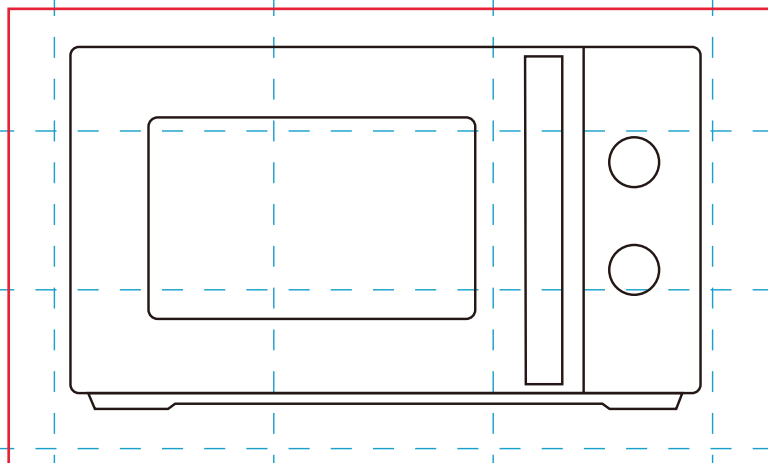

СЪДЪРЖАНИЕ

БЕЗОПАСНОСТ ПРИ ЕКСПЛОАТАЦИЯ

Мерки за безопасност против излагане на повишени нива микровълново лъчение	BG-01
Важни указания относно безопасността	BG-03
Заземяване на инсталацията с цел намаляване на риска от нараняване	BG-07
Почистване	BG-09
Съдове и контейнери	BG-10
Материали, които могат да бъдат използвани при микровълново готвене	BG-11
Материали, които не могат да бъдат използвани при микровълново готвене	BG-13

ПОДГОТОВКА ЗА РАБОТА

Подготовка на фурната за работа	BG-14
---------------------------------------	-------

УКАЗАНИЯ ЗА УПОТРЕБА

Преди първоначална употреба	BG-17
Експлоатация	BG-18
ПОЧИСТВАНЕ	BG-20

ПРОФИЛАКТИКА И ПОДДРЪЖКА

Отстраняване на неизправности	BG-22
-------------------------------------	-------



ЗАБЕЛЕЖКА

ПРЕДИ ДА ИЗПОЛЗВАТЕ ТОЗИ ПРОДУКТ Е НЕОБХОДИМО ДА ПРОЧЕТЕТЕ, РАЗБЕРЕТЕ И СПАЗВАТЕ ТЕЗИ УКАЗАНИЯ.
ЗАПАЗЕТЕ ТОЗИ НАРЪЧНИК ЗА БЪДЕЩИ СПРАВКИ.

БЕЗОПАСНОСТ ПРИ ЕКСПЛОАТАЦИЯ

МЕРКИ ЗА БЕЗОПАСНОСТ ПРОТИВ ИЗЛАГАНЕ НА ПОВИШЕНИ НИВА МИКРОВЪЛНОВО ЛЪЧЕНИЕ

- (a). Не опитвайте да работите с фурната при отворена врата. Това може да доведе до излагане на микровълново лъчение. Пазете обезопасителните блокиращи устройства от повреди и не ги модифицирайте по никакъв начин.
- (b). Не поставяйте нищо между лицевата страна и вратата на фурната; не позволявайте върху уплътнителните повърхности да се натрупват остатъци от храна или почистващи препарати.
- (c). **ПРЕДУПРЕЖДЕНИЕ:** Ако вратата или уплътненията са повредени, фурната не може да се използва, преди повредата да бъде отстранена от компетентно лице.

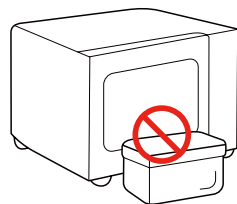

ДОПЪЛНЕНИЕ

Ако този уред не бъде поддържан в добро състояние на чистота, повърхностите му ще започнат да се увреждат, което ще доведе до намаляване на експлоатационния му живот и възможни рискови ситуации.

ХАРАКТЕРИСТИКИ

МОДЕЛ:	MW-MM20P(ВК)/MW-MM20P(WH)
--------	---------------------------

НОМИНАЛНО НАПРЕЖЕНИЕ/ЧЕСТОТА:	230 -240V~ 50 Hz
-------------------------------	------------------

НОМИНАЛНА КОНСУМИРАНА МОЩНОСТ (МИКРОВЪЛНИ):	1200-1270 W
--	-------------

НОМИНАЛНА ИЗХОДНА МОЩНОСТ (МИКРОВЪЛНИ):	750-800 W
--	-----------



ЗАБЕЛЕЖКА

Всички изображения в този наръчник имат единствено илюстративна цел и е възможно да има леки различия с действителния облик на закупеното оборудване.
В този случай вж. действителния продукт.

ВАЖНИ УКАЗАНИЯ ОТНОСНО БЕЗОПАСНОСТТА



ПРЕДУПРЕЖДЕНИЕ

За да намалите риска от токов удар, пожар, нараняване на хора или излагане на повишени нива микровълново лъчение по време на употреба на продукта, е необходимо да спазвате някои основни правила за безопасност, а именно:



Прочетете и спазвайте следното: "**МЕРКИ ЗА БЕЗОПАСНОСТ ПРОТИВ ИЗЛАГАНЕ НА ПОВИШЕНИ НИВА МИКРОВЪЛНОВО ЛЪЧЕНИЕ**".



Този уред може да бъде използван от деца над 8 годишна възраст, лица с намалени физически, сетивни или умствени възможности, както и от такива с липса на опит и познание, единствено когато са наблюдавани и инструктирани как да работят с него по безопасен начин и разбират рисковете, които могат да възникнат. Децата не трябва да си играят с уреда. Почистването и профилактиката не трябва да бъдат изпълнявани от деца без родителски надзор.



Съхранявайте уреда и захранващия кабел на места, недостъпни за деца на възраст под 8 години.

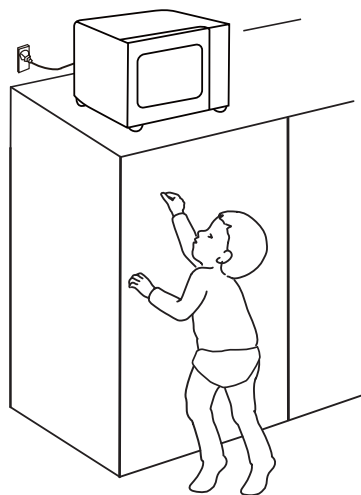



В случай че захранващият кабел бъде повреден, е необходимо същият да бъде заменен от производителя,

ВАЖНИ УКАЗАНИЯ ОТНОСНО БЕЗОПАСНОСТТА

негов сервизен представител или лице с подобна квалификация, с цел предотвратяване на евентуална опасност.

 **ПРЕДУПРЕЖДЕНИЕ:** С цел избягване възможността от токов удар, преди да пристъпите към смяна на крушката се уверете, че уредът е изключен.

 **ПРЕДУПРЕЖДЕНИЕ:** Изпълняването на каквито и да било ремонтни дейности, включващи свалянето на предпазния капак за микровълни от лице, което не е компетентно за последните е опасно.

 **ПРЕДУПРЕЖДЕНИЕ:** Течности и други храни не трябва да бъдат затопляни в запечатани опаковки, защото могат да избухнат;

 Ако затопляте храна в пластмасови или хартиени опаковки, наблюдавайте фурната поради опасност от запалване.



 Използвайте единствено съдове, които са подходящи за употреба в микровълнова фурна.

 Ако забележите да се отделя дим, изключете фурната от захранването и не отваряйте вратата, за да прекъснете достъпа на кислород до огъня.

 При нагриване на напитки с микровълни може да възникне забавено кипене. Ето защо съдът трябва да бъде докосван внимателно.

 За да се избегнат изгаряния, съдържанието на шишета и буркани с детски храни трябва да бъде разклатено

ВАЖНИ УКАЗАНИЯ ОТНОСНО БЕЗОПАСНОСТТА

преди употреба, а температурата – проверена.

 Важно е редовно да почиствате фурната и да се отървете от всякакви остатъци от храна. Благодарим ви, че поддържате чистотата в зоната на вълновода. Ако върху зоната на вълновода или кухнята има остатъци от пръски храна, почистете ги с мека, влажна кърпа. Неотстраняването на остатъците от храна може да доведе до безобидно искрене, малко количество дим и/или промяна на цвета на микровълновата кухня.

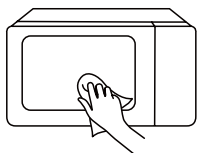

 Липсата на поддръжка може да доведе до влошаване на състоянието на повърхностите, като това може да повлияе неблагоприятно върху

живота на уреда и да причини опасни ситуации.

 Използвайте единствено сонди за отчитане на температура, които се препоръчват за тази фурна. (Отнася се за фурни, разполагащи с възможност за отчитане на температурата посредством сонда.)

 Микровълновата фурна може да бъде използвана единствено ако декоративната врата е отворена. (Отнася се за фурни с декоративна врата.)

 Този уред е предназначен да бъде използван за битово и друго подобно приложение, като например:

1. в кухненски помещения за персонал в магазини, офиси и др.;
2. от клиенти в хотели, мотели и други места за настаняване;
3. в земеделски стопанства;
4. в места за настаняване тип нощувка и закуска.

ВАЖНИ УКАЗАНИЯ ОТНОСНО БЕЗОПАСНОСТТА

 Микровълновата фурна е предназначена да затопля храна и напитки. Сушенето на храна или дрехи, както и нагряването на отоплителни подложки, чехли, гъби, влажни кърпи и т.н. може да доведе до риск от нараняване или пожар.

 Този продукт е предназначен за употреба в свободностоящо състояние.

 Задната страна на уреда трябва да бъде разположена срещу стена.

 Избягвайте поставянето на яйца в черупки и цели твърдо сварени яйца в микровълновата фурна, тъй като е възможно да експлодират, дори и след приключване на затоплянето.

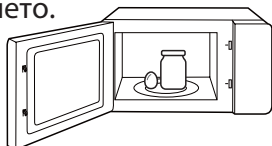

 Уредът не трябва да бъде разполаган зад декоративни врати и прегради, тъй като е възможно да се стигне до прегряване. (Това не се отнася за уреди с декоративни врати.)

 Микровълновата фурна не трябва да бъде поставяна в шкаф, освен ако за целта не са проведени изпитвания.

 Употребата на метални съдове за храна или напитки по време на микровълново готвене не е позволена.

 Не използвайте пара за почистване.

ПРОЧЕТЕТЕ ВНИМАТЕЛНО И ЗАПАЗЕТЕ ЗА БЪДЕЩИ СПРАВКИ

ЗАЗЕМЯВАНЕ НА ИНСТАЛАЦИЯТА С ЦЕЛ НАМАЛЯВАНЕ НА РИСКА ОТ НАРАНЯВАНЕ

Уредът трябва да бъде заземен. В случай на късо съединение заземяването намалява риска от токов удар, осигурявайки безопасен проводник за утечка на тока.

Този уред разполага със заземителен кабел и щепсел. Щепселът следва да бъде включен в контакт, който е надлежно монтиран и заземен.

ПРЕДУПРЕЖДЕНИЕ – Неправилното заземяване може да доведе до опасност от токов удар. В случай че изпитвате съмнения дали уредът е заземен надлежно или не сте разбрали указанията напълно, моля посъветвайте се с квалифициран електротехник. Ако се налага да използвате удължител, е необходимо същият да бъде трижилен.



ОПАСНОСТ

Опасност от токов удар:

При докосване на вътрешните компоненти могат да възникнат сериозни наранявания или смърт. Не разглобявайте този уред.

ЗАЗЕМЯВАНЕ НА ИНСТАЛАЦИЯТА С ЦЕЛ НАМАЛЯВАНЕ НА РИСКА ОТ НАРАНЯВАНЕ



**ПРЕДУПРЕ-
ЖДЕНИЕ**

Опасност от токов удар:

Неправилното заземяване може да причини токов удар. Не включвайте в електрически контакт преди уредът да бъде надлежно монтиран и заземен.

1. Предоставен е къс захранващ кабел, с цел намаляване възможността от заплитане или настъпване.
2. При употреба на дълъг захранващ кабел е необходимо:
 - (1). Електрическите характеристики, посочени върху маркировката на кабела или удължителя трябва да бъдат поне равни или по-големи тези на табелката на уреда.
 - (2). Удължителният кабел трябва да бъде трижилен със заземяване.
 - (3). По-дългият кабел трябва да бъде разположен по такъв начин, че да не виси над плота или масата, където може да бъде непреднамерено дръпнат или съборен.

ПОЧИСТВАНЕ

Уверете се, че уредът е изключен от електрическата мрежа.

1. След употреба почистете вътрешната част на фурната с леко навлажнена кърпа.
2. Почистете аксесоарите по общоприетия начин със сапунена вода.
3. Рамката на вратата, уплътненията и съседните части трябва да бъдат почиствани внимателно с навлажнена кърпа.
4. Не използвайте абразивни препарати или остри метални стъргалки за почистване на стъклото на вратата, тъй като повърхността му може да бъде надраскана и впоследствие спукана.
5. Съвет: За по-лесно почистване на вътрешните повърхности: Поставете половин лимон в купа, добавете 300 ml вода и загрейте на 100% микровълнова мощност за 10 минути. Избършете фурната с мека и суха кърпа.

СЪДОВЕ



ВНИМАНИЕ

Опасност от нараняване:

Изпълняването на каквито и да било ремонтни дейности, включващи свалянето на предпазния капак за микровълни от лице, което не е компетентно за последните е опасно. Вж.

указанията в **"Материали, които могат да бъдат използвани при микровълново готвене"** или **"Материали, които не могат да бъдат използвани при микровълново готвене"**

Възможно е да има определени съдове, които не са от метал, но въпреки това са опасни за използване при микровълново готвене. В случай че изпитвате съмнения, можете да изпитате въпросния съд, като изпълните указанията по-долу.

Изпитване на съдове:

1. Напълнете съд, подходящ за микровълнова фурна, с ок. 250 ml студена вода. Поставете го във фурната заедно със съда, който искате да изпитате.
2. Включете фурната на максимална мощност за 1 минута.
3. Внимателно докоснете съда. Ако празният съд е топъл, не го използвайте за микровълново готвене.
4. Не превишавайте времетраене от 1 минута.

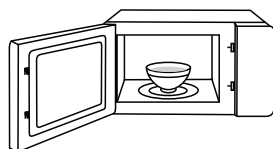

ЗАБЕЛЕЖКА

ПОДДЪРЖАЙТЕ ВЪТРЕШНИТЕ ПОВЪРХНОСТИ И ВЪЛНОВОДА ВИНАГИ ЧИСТИ

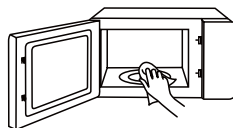

МАТЕРИАЛИ, КОИТО МОГАТ ДА БЪДАТ ИЗПОЛЗВАНИ ПРИ МИКРОВЪЛНОВО ГОТВЕНЕ

СЪДОВЕ

ЗАБЕЛЕЖКИ



Гювече

Спазвайте указанията на производителя. Дъното на съда за запичане трябва да бъде на поне 5 mm над въртящата чиния. При неправилна употреба, въртящата чиния може да се счупи.



Домакински съдове

Единствено такива, които са подходящи за микровълнова фурна. Спазвайте указанията на производителя. Не използвайте надраскани или напукани съдове.



Стъклени буркани

Винаги сваляйте капака. Използвайте единствено за леко затопляне на храна. Повечето стъклени буркани не са топлоустойчиви и е възможно да се счупят.



Стъклени съдове

Можете да използвате единствено топлоустойчиви стъклени съдове, подходящи за фурна. Уверете се, че нямат метален кант. Не използвайте надраскани или напукани съдове.



Торбички за готвене на фурна

Спазвайте указанията на производителя. Не затваряйте с метални закопчалки. Направете прорези, така че парата да може да излиза.



Картонени чинии и чаши

Използвайте единствено при готвене с кратко времетраене или затопляне на храна. По време на готвене не оставяйте фурната без наблюдение.



Хартиени кърпи

Служи за покриване на храната при затопляне и поглъщане на мазнина. Да се използва винаги под наблюдение, единствено при готвене с кратко времетраене.



Пергаментова хартия

Може да бъде използвано като покривало за предотвратяване на пръски или обвивка за задушаване на храната.



МАТЕРИАЛИ, КОИТО МОГАТ ДА БЪДАТ ИЗПОЛЗВАНИ ПРИ МИКРОВЪЛНОВО ГОТВЕНЕ

СЪДОВЕ

ЗАБЕЛЕЖКИ



Пластмаса

Единствено такива, които са подходящи за микровълнова фурна. Спазвайте указанията на производителя. Необходимо е да има етикет, указващ пригодност за употреба в микровълнова фурна. Някои съдове от пластмаса омекват, когато храната в тях се нагорещи. Готварските торби и плътно затворените полиетиленови торбички трябва да бъдат разрязани, пробити или вентилирани, съгласно указанията на опаковката.



Полиетиленово фолио

Единствено такива, които са подходящи за микровълнова фурна. Покрийте храната, за да задържите влагата в нея. Внимавайте полиетиленово фолио да не се докосва до храната.

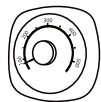

Термометри

Единствено такива, които са подходящи за микровълнова фурна (термометри за месо и сладкиши)



Восъчна хартия

Покрийте храната, за да предотвратите пръски по стените и да задържите влагата в нея.



МАТЕРИАЛИ, КОИТО НЕ МОГАТ ДА БЪДАТ ИЗПОЛЗВАНИ ПРИ МИКРОВЪЛНОВО ГОТВЕНЕ

СЪДОВЕ

ЗАБЕЛЕЖКИ



Алуминиева тава

Може да причини образуване на дъга. Прехвърлете храната в съд, подходящ за микровълнова фурна.



Картонена опаковка за храна с метална дръжка

Може да причини образуване на дъга. Прехвърлете храната в съд, подходящ за микровълнова фурна.



Съдове от метал или с метален кант

Металът предпазва храната от микровълновата енергия. Металните кантове могат да причинят образуване на дъга.



Метални закопчалки

Могат да причинят образуване на дъга или пожар.



Хартиени пликове

Могат да се запалят във фурната.



Пореста пластмаса

При излагане на висока температура порестата пластмаса може да се разтопи или да замърси храната, поставена в нея.



Дърво

Ако бъде използвано в микровълнова фурна, дървото може да се напука или разцепи.



ПОДГОТОВКА ЗА РАБОТА

ПОДГОТОВКА НА ФУРНАТА ЗА РАБОТА

НАИМЕНОВАНИЯ НА ЧАСТИТЕ И АКСЕСОАРИТЕ

Извадете уреда и всички компоненти от картонената кутия. Отстранете всички опаковъчни материали от вътрешността на фурната.

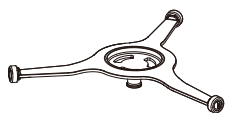

Сглобяем остов на
грамофонна платформа

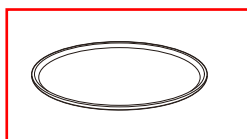

Съвкупна плоча

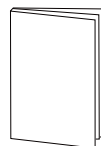

Ръководство за експлоатация

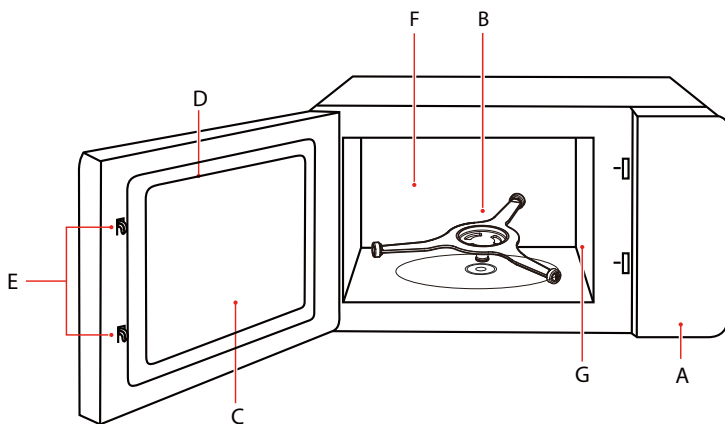

- A. Панел за управление
- B. Сглобяем остов на грамофонна платформа
- C. Прозорец
- D. рата
- E. Обезопасителни блокиращи устройства
- F. Кухненска камера
- G. Капак на вълновода

ПОДГОТОВКА НА ФУРНАТА ЗА РАБОТА

МОНТАЖ НА ВЪРТЯЩАТА ЧИНИЯ

Почистване на вътрешността на фурната и поставяне на въртящата чиния.

Ако уредът е нов се уверете, че всички опаковъчни материали и транспортни ленти са отстранени от задвижващия вал.

Преди да пристъпите към употреба на уреда за пръв път, е необходимо да поставите въртящата чиния по надлежен начин. Вътрешността на фурната и аксесоарите трябва да бъдат почистени.

Начин за монтаж на въртящата чиния:

How to put the turntable in place:

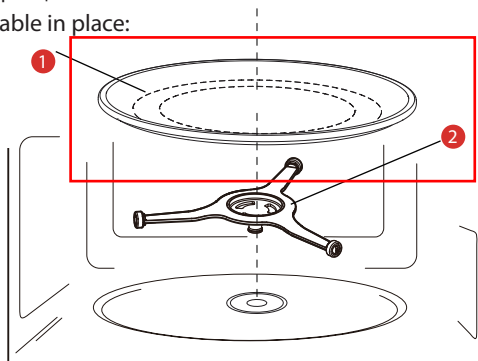

1. Стъклена плоча
2. Сглобяем остов на грамофонна платформа

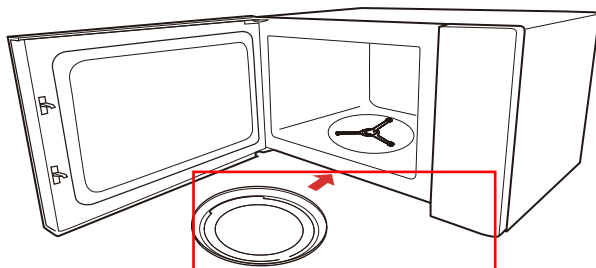

- Никога не включвайте микровълновата фурна без поставена въртяща чиния. Уверете се, че е захваната надлежно. Въртящата чиния може да се върти както по посока на часовниковата стрелка, така и обратно на нея.
- Никога не поставяйте въртящата чиния обърната наопаки. Движението на стъклената плоча не трябва никога да бъде ограничавано.
- По време на използване на микровълновата фурна стъклената плоча и водещата ролка трябва винаги да бъдат поставени.
- При готвене храната или съдът, в която е поставена, трябва винаги да бъдат разположени върху стъклената плоча.
- Ходът на въртящата чиния не трябва никога да бъде ограничаван.
- В случай че стъклената плоча или водещата ролка се напукат или счупят, се свържете с най-близкия упълномощен сервизен център.



ЗАБЕЛЕЖКА

МОНТИРАНЕ В КУХНЕНСКИ ПЛОТ

Отстранете всички опаковъчни материали и аксесоари. Огледайте добре фурната за повреди, вдлъбнатини или неизправност на вратата. В случай че е повредена, не я монтирайте.

Кабинет: Снемете всички защитни покрития, намиращи се на повърхността на шкафа на микровълновата фурна. Капакът на вълновода, който е закрепен към кухнята на фурната, за да предпазва магнетрона, не трябва да се сваля.

МОНТАЖ

1. Изберете равна повърхност, осигуряваща достатъчно свободно пространство за вентилационните отвори.
 - a. Минималното отстояние от пода е 85 cm.
 - b. Задната страна на уреда трябва да бъде разположена срещу стена. Минималното свободно пространство, което трябва да бъде оставено над фурната е 30 cm. Минималното отстояние от фурната до съседните стени е 20 cm.
 - c. Не отстранявайте крачетата от дъното на фурната.
 - d. Блокирането на вентилационните отвори може да доведе до повреда на фурната.
 - e. Поставете фурната възможно най-далеч от радиоприемници и телевизори. Нейната работа може да предизвика смущения в радиотелевизионния сигнал.

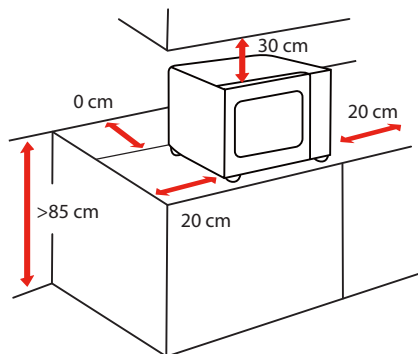

2. Включете микровълновата фурна в стандартен електрически контакт. Уверете се, че входното напрежение и честота съвпадат с тези, посочени върху етикета на продукта.



ЗАБЕЛЕЖКА

- Не поставяйте фурната върху готварски плот или в непосредствена близост до други източници на топлина.

В случай че този продукт бъде разположен в непосредствена близост или върху друг източник на топлина, могат да възникнат повреди, което биха направили гаранцията невалидна.

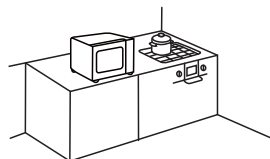

По време на употреба откритите части могат да се нагорещат

УКАЗАНИЯ ЗА УПОТРЕБА

ПРЕДИ ПЪРВОНАЧАЛНА УПОТРЕБА

При първоначалната употреба е възможно да усетите неприятна миризма.

В този раздел ще намерите информацията относно нещата, които трябва да направите, преди да използвате микровълновата фурна за пръв път. Преди всичко останало, прочетете раздел "**ВАЖНИ УКАЗАНИЯ ОТНОСНО БЕЗОПАСНОСТТА**" на стр. 3.

Преди да използвате този уред, е необходимо да поставите въртящата чиния правилно. Освен това, вътрешността на уреда и аксесоарите трябва да бъдат почистени.



ЗАБЕЛЕЖКА

- Никога не включвайте микровълновата фурна без поставена въртяща чиния.
- Уверете се, че е захваната надлежно. Въртящата чиния може да се върти както по посока на часовниковата стрелка, така и обратно на нея.

ЕКСПЛОАТАЦИЯ



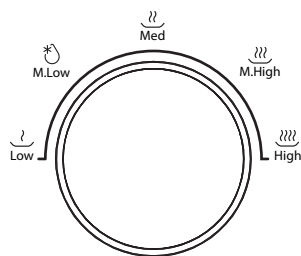

 POWER

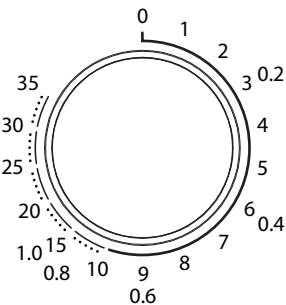

 TIMER Min / DEFROST kg



1. Задайте мощност чрез завъртане на селектора до желаното ниво.
2. Задайте желаното времетраене чрез завъртане на таймера, като спазвате указанията в ръководството за готвене.
3. След задаване на ниво на мощност и времетраене, фурната автоматично ще стартира готвене.
4. След като зададеното времетраене изтече, ще прозвучи звуков сигнал и фурната ще се изключи.
5. Когато уредът не се използва, винаги задавайте времетраене "0".

Функция/Мощност	Изх. мощност	Приложение
	17% микровълнова мощност	Омекотяване на сладолед
	33% микровълнова мощност	Яхния, разтопяване на масло или размразяване
	55% микровълнова мощност	Яхния, риба
	77% микровълнова мощност	Ориз, риба, пиле, кайма
	100% микровълнова мощност	Затопляне, мляко, кипване на вода, зеленчуци, напитки

Забележка: Когато изваждате храна от фурната, се уверявайте, че захранването е изключено, като завъртите таймера до първоначалната позиция. Ако не го направите и фурната работи без поставена в нея храна, това може да доведе до прегряване и повреда на магнетрона.

ПОЧИСТВАНЕ И ПРОФИЛАКТИКА

ПОЧИСТВАНЕ

При полагане на необходимите грижи и надлежно почистване, този уред ще запази добрия си външен вид и ще остане напълно функционален за дълго. По-долу ще Ви обясним как да правите това.



ПРЕДУПРЕЖДЕНИЕ

- Евентуално надраскване на стъклото на вратата може да се превърне в пукнатина. При почистване не използвайте стъргалки или други остри предмети, както и агресивни препарати с абразивно действие.
- При неправилно почистване покритието на уреда може да бъде повредено. Това би довело до изпускане на микровълново лъчение. Почиствайте уреда редовно и премахвайте незабавно всякакъв вид разсипана храна.
- Не потапяйте уреда във вода и не го почиствайте с водна струя.

Препарати за почистване

За да избегнете амортизиране на повърхностите вследствие използването на неподходящи препарати, моля запознайте се с информацията по-долу. Измивайте добре новите домакински гъби или кърпи, преди да ги използвате.

Не използвайте:



Агресивни почистващи препарати с абразивно действие



Стъргалки за метал или стъкло, за почистване на панелите на вратата

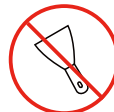

Стъргалки за метал или стъкло, за почистване на уплътненията на вратата



Домакинска тел и твърди кухненски гъби



Почистващи препарати с високо съдържание на алкохол

ПРЕДНА ЧАСТ

Гореща сапунена вода:

Почистете като избършете първо с влажна, а след това с мека суха кърпа. При почистване не използвайте стъргалки.

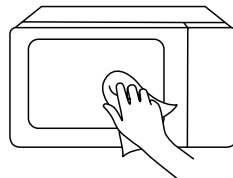

ПРЕДНА ПЛОЧА

Гореща сапунена вода:

Почистете като избършете първо с влажна, а след това с мека суха кърпа.

Отстранявайте незабавно пръски и петна от варовик, мазнина, нишесте и албумин. Тяхното натрупване може да доведе до образуване на корозия. При почистване не използвайте препарати за почистване на стъкло или стъргалки.

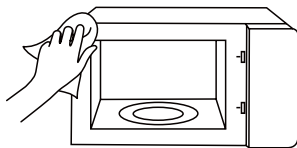

ВЪТРЕШНОСТ

Гореща сапунена вода или оцетов разтвор:

Почистете като избършете първо с влажна, а след това с мека суха кърпа. Не използвайте препарати за почистване на фурна или други агресивни субстанции с абразивно действие. Освен това, тампони за почистване от метал, груби домакински гъбички и домакинска тел също са неподходящи за почистване на фурната. Те биха надраскали повърхността. Изчакайте, докато вътрешните повърхности изсъхнат напълно.

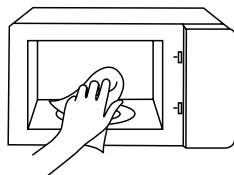

ГНЕЗДО ЗА РАЗПОЛАГАНЕ НА ВЪРТЯЩАТА ЧИНИЯ

Навлажнена кърпа:

Не допускате проникването на вода в уреда посредством задвижващия механизъм на въртящата чиния. Подсушавайте задвижващия механизъм с кърпа.

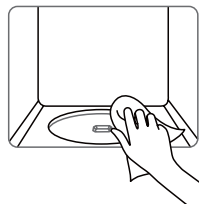

ВЪРТЯЩА ЧИНИЯ И ВОДЕЩА РОЛКА

Гореща сапунена вода:

При поставяне на въртящата чиния се уверете, че е захваната надлежно в гнездото.

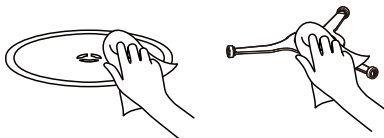

ВРАТА

Препарат за стъкло:

Почиствайте с кърпа за съдове. Не използвайте стъргалки за стъкло.

ОТСТРАНЯВАНЕ НА НЕИЗПРАВНОСТИ

Опитайте решенията за всеки проблем, след като използвате таблицата по-долу, за да проверите проблема си. Свържете се с най-близкия оторизиран сервиз, ако микровълновата фурна все още не функционира правилно.

ПРОБЛЕМ	ВЕРОЯТНА ПРИЧИНА	ВЪЗМОЖНО РЕШЕНИЕ
Фурната не се стартира	<ul style="list-style-type: none">a. Електрическият кабел на фурната не е включен в контакта.b. Вратата е отворена.v. Избрана е неправилна операция.	<ul style="list-style-type: none">a. Свържете към контакта.b. Заклучете вратата и опитайте още веднъж.v. Проверете указанията
Зарязване или искрене	<ul style="list-style-type: none">a. Използвани са предмети, които не трябва да се използват в микровълнова фурна.b. Фурната е използвана, когато е празна.v. Храната, която се е разляла, остава в кухнята.	<ul style="list-style-type: none">a. Използвайте само съдове за готвене, които са безопасни за микровълнова фурна.b. Никога не използвайте фурна, която е празна.v. Почистете кухнята с влажна кърпа.
Неравномерно сготвени храни	<ul style="list-style-type: none">a. Използвани са предмети, които не трябва да се използват в микровълнова фурна.b. Храната не се е размразила напълно.v. Нивото на мощност е недостатъчно за времето за готвене.г. Ястието не е обърнато или разбъркано.	<ul style="list-style-type: none">a. Използвайте само съдове за готвене, подходящи за микровълнова фурнаb. Размразявайте напълно храната.v. Използвайте подходящата мощност и време за готвене.г. Разбърквайте или обръщайте храната.
Прекалено сготвени храни	Времето за готвене и нивото на мощност са недостатъчни.	Използвайте подходящата мощност и време за готвене.
Недостатъчно сготвени храни	<ul style="list-style-type: none">a. Използвани са предмети, които не трябва да се използват в микровълнова фурна.b. Храната не се е размразила напълно.v. Вентилационните отвори във фурната са ограничени.г. Времето за готвене и нивото на мощност са неподходящи.	<ul style="list-style-type: none">a. Използвайте само съдове за готвене, които са подходящи за микровълнова фурна.b. Размразете напълно храната.v. Проверете дали вентилационните отвори на фурната не са блокирани.г. Използвайте правилното време за готвене и ниво на мощност.
Неправилно размразяване	<ul style="list-style-type: none">a. Използвани са предмети, които не трябва да се използват в микровълнова фурна.b. Неподходящо ниво на мощност и време за готвене.v. Не е извършено обръщане или почистване на храната.	<ul style="list-style-type: none">a. Използвайте само съдове за готвене, подходящи за микровълнова фурна.b. използвайте препоръчаното време за готвене и ниво на мощност.v. Разбъркайте или обърнете храната.



Съгласно Директивата за отпадъците от електрическо и електронно оборудване (ОЕЕО), ОЕЕО трябва да се събират и изхвърлят отделно. Ако в бъдеще ви се наложи да изхвърлите този продукт, моля, не го изхвърляйте заедно с битовите си отпадъци. Моля, занесете този продукт в пункт за събиране на ОЕЕО, където има такъв.

#DetailsMatter

MIKROVALNA PEĆNICA

MW-MM20P(BK)/MW-MM20P(WH)

Pročitajte ovaj priručnik s uputama prije korištenja aparata.

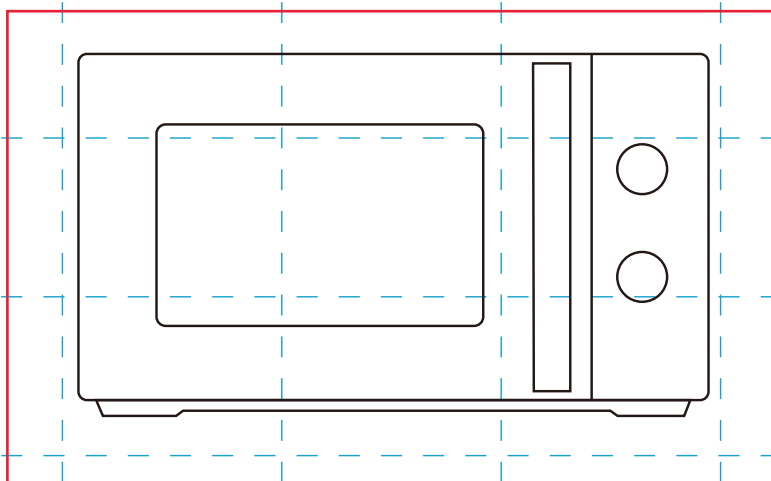

SADRŽAJ

SIGURNOST PROIZVODA

Mjere pozornosti radi izbjegavanja izlaganja prekomjernoj mikrovalnoj energiji	HR-01
Važne upute za sigurnost	HR-03
Upute za uzemljenje radi smanjenja rizika od fizičkih ozljeda	HR-07
Čišćenje	HR-09
Posuđe	HR-10
Materijali koji se mogu koristiti u mikrovalnoj pećnici	HR-11
Materijali koji se ne mogu koristiti u mikrovalnoj pećnici	HR-13

POSTAVLJANJE PROIZVODA

Postavljanje pećnice	HR-14
----------------------------	-------

UPUTE ZA UPORABU

Prije korištenja prvi put	HR-17
Rukovanje	HR-18
ČIŠĆENJE	HR-20

ODRŽAVANJE

Otklanjanje problema	HR-22
----------------------------	-------



NAPOMENA

PRIJE KORIŠTENJA OVOG PROIZVODA MORATE PROČITATI, RAZUMJETI I SLIJEDITI OVE UPUTE. OBAVEZNO POHRANITE OVU KNJIŽICU ZA PODSJEĆANJE U BUDUĆNOSTI.

MJERE OPREZA ZA IZBJEGAVANJE MOGUĆEG IZLAGANJA PREKOMJERNOJ MIKROVALNOJ ENERGIJI

(a). Ne pokušavajte koristiti ovu pećnicu s otvorenim vratima jer takvo korištenje može dovesti do štetnog izlaganja mikrovalnoj energiji.

Važno je ne deaktivirati i ne kvariti sigurnosne blokade.

(b). Nemojte stavljati bilo kakav predmet između prednje strane pećnice i vrata niti dopuštati da se na brtvenim površinama sakuplja prljavština ili ostaci sredstva za čišćenje.

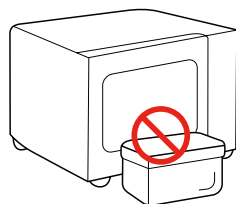

(c). **UPOZORENJE:** Ako su vrata ili brtve vrata oštećeni, pećnica se ne smije koristiti dok ih stručna osobe ne popravi.

DODATAK

Ako se aparat ne održava čistim, njegove površine mogu propasti i utjecati na radni vijek aparata, kao i dovesti do opasne situacije.

SPECIFIKACIJE

MODEL: MW-MM20P(BK)/MW-MM20P(WH)

NAZIVNI NAPON/FREKVENCIJA:: 230-240 V~ 50 Hz

NAZIVNA ULAZNA SNAGA (MIKROVALNA): 1200-1270 W

NAZIVNA IZLAZNA SNAGA (MIKROVALNA): 750-800 W



NAPOMENA

Sve slike u ovom priručniku služe samo kao ilustracija; mogu se razlikovati od kupljene opreme u određenoj mjeri; imajte u vidu stvarni proizvod.

VAŽNE UPUTE ZA SIGURNOST



UPOZORENJE

Da bi ste smanjili rizik od požara, strujnog udara, ozljeda osoba ili izlaganja prekomjernoj mikrovalnoj energiji prilikom korištenja aparata, slijedite temeljne mjere pozornosti, uključujući sljedeće:



Pročitajte i slijedite:
**„MJERE POZORNOSTI
ZA IZBJEGAVANJE
POTENCIJALNOG
IZLAGANJA
PREKOMJERNOJ
MIKROVALNOJ ENERGIJI“.**



Ovaj aparat mogu koristiti djeca uzrasta 8 i više godina, kao i osobe smanjenih fizičkih, senzornih ili mentalnih mogućnosti ili sa nedostatkom iskustva i znanja ako su bili pod nadzorom ili ih je neko naučio sigurnom korištenju aparata te razumiju opasnosti koje ga prate. Djeca se ne smiju igrati aparatom. Čišćenje i korisničko održavanje ne smiju obavljati djeca bez nadzora.



Držite aparat i njegov kabel izvan domašaja djece mlađe od 8 godina.

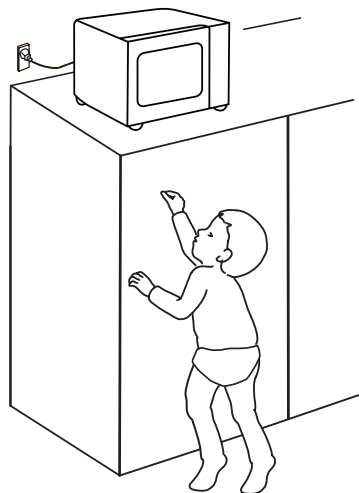



Ako je kabel za napajanje oštećen, mora ga zamijeniti proizvođač, njegov serviser ili

VAŽNE UPUTE ZA SIGURNOST

slično kvalificirane osobe kako bi se izbjegla opasnost.

 **UPOZORENJE:** Povedite računa da aparat isključite prije zamjene lampe kako biste izbjegli mogućnost strujnog udara.

 **UPOZORENJE:** Opasno je da bilo tko osim stručne osobe obavlja bilo kakvo servisiranje ili popravke koji obuhvaćaju uklanjanje poklopca koji štiti od izlaganja mikrovalnoj energiji.

 **UPOZORENJE:** Tekućine i druga hrana ne smiju se zagrijavati u hermetički zatvorenim posudama jer one mogu eksplodirati.

 Prilikom kuhanja hrane u plastičnim ili papirnim posudama, držite pećnicu na oku zbog mogućnosti paljenja.



 Koristite isključivo posuđe koje je pogodno za uporabu u mikrovalnim pećnicama.

 Ako aparat emitira dim, isključite ga ili ga iskopčajte i ostavite vrata zatvorena kako biste prigušili eventualni plamen.

 Zagrijavanje napitaka u mikrovalnoj pećnici može dovesti do odloženog eruptivnog ključanja, te je stoga neophodna pažnja pri rukovanju posudom.

 Sadržaj bočica za hranjenje i staklenki s hranom za bebe mora se promiješati ili

VAŽNE UPUTE ZA SIGURNOST

protresti, a temperatura se mora provjeriti prije konzumiranja kako bi se izbjegle ozljede.

 Važno je redovito čistiti pećnicu i riješiti se svih ostataka hrane. Hvala vam što održavate područje valovoda urednim. Ako na području valovoda ili šupljini ima ostataka hrane, očistite ih mekom, vlažnom krpom. Ako se ostaci hrane ne uklone, može doći do bezo-pasnog iskrenja, male količine dima i/ili promjene boje mikrovalne pećnice.

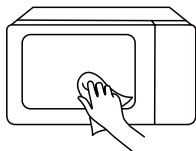

 Ako se pećnica ne održava u čistom stanju, površine mogu propasti, što može

imati negativan utjecaj na radni vijek aparata i potencijalno dovesti do opasne situacije.

 Koristite isključivo temperaturnu sondu preporučenu za ovu pećnicu. (kod pećnica koje imaju mogućnost korištenja sondi sa senzorima temperature)

 Mikrovalna pećnica se mora koristiti s otvorenim dekorativnim vratima. (kod pećnica koje imaju dekorativna vrata)

 Aparat je namijenjen za korištenje u domaćinstvu i sličnim primjenama kao što su:

1. kuhinjske oblasti za osoblje u radnjama, kancelarijama i drugim radnim okruženjima;

VAŽNE UPUTE ZA SIGURNOST

2. od strane klijenata u hotelima, motelima i drugim stambenim okruženjima;
3. kuće na farmama;
4. okruženja prenoćišta s doručkom.

 Mikrovalna pećnica je predviđena za zagrijavanje hrane i napitaka. Sušenje hrane ili odjeće i zagrijavanje jastuka za grijanje, papuča, spužvi, vlažnih krpa i sličnog može dovesti do rizika od ozljede, paljenja ili požara.

 Aparat je namijenjen za uporabu kao samostalno stojeći aparat.

 Stražnja površina aparata se mora postaviti uza zid.

 Jaja u ljusci i cijela tvrdo kuhana jaja ne smiju se zagrijavati u mikrovalnoj pećnici jer mogu eksplodirati, čak i nakon što se mikrovalno zagrijavanje završi.

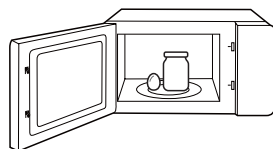

 Aparat se ne smije postavljati iza dekorativnih vrata kako bi se izbjeglo pregrijavanje. (Ovo ne vrijedi za aparate s dekorativnim vratima.)

 Mikrovalna pećnica se ne smije stavljati u ormar, osim ako je testirana u ormaru.

 Metalne posude za hranu i napitke nisu dopuštene prilikom kuhanja u mikrovalnoj pećnici.

 Aparat se ne smije čistiti paročišćem.

**PAŽLJIVO PROČITAJTE
I POHRANITE ZA UPORABU
U BUDUĆNOSTI**

UPUTE ZA UZEMLJENJE RADI SMANJENJA RIZIKA OD FIZIČKIH OZLJEDA

Ovaj aparat mora biti uzemljen. U slučaju kratkog spoja, uzemljenje smanjuje rizik od strujnog udara tako što odvodi električnu struju.

Ovaj aparat je opremljen kabelom koji ima provodnik uzemljenja s uzemljenim utikačem. Utikač se mora prikopčati u utičnicu koja je pravilno ugrađena i uzemljena.

UPOZORENJE - Nepravilno korištenje uzemljenja može dovesti do rizika od strujnog udara. Ako upute za uzemljenje ne razumijete u potpunosti ili ste u nedoumici da li je aparat pravilno uzemljen, posavjetujte se s kvalificiranim električarom ili serviserom.

Ako morate koristiti produžni kabel, koristite isključivo 3-žilni produžni kabel.



OPASNOST

Opasnost od električne utičnice:
Dodirivanje nekih unutarnjih komponenti
može izazvati ozbiljne fizičke ozljede ili smrt.
Nemojte rasklapati ovaj aparat.

UPUTE ZA UZEMLJENJE RADI SMANJENJA RIZIKA OD FIZIČKIH OZLJEDA



UPOZORENJE

Opasnost od električne utičnice:

Neppravilno korištenje uzemljenja može dovesti do strujnog udara. Nemojte prikopčavati aparat u utičnicu dok ne bude pravilno postavljen i uzemljen.

1. Priložen je kratak kabel za napajanje kako bi se smanjili rizici koji proističu iz zapetljavanja ili spoticanja o dulji kabel.
2. Ako se koristi dugačak ili produžni kabel:
 - (1). Naznačena električna snaga seta kabela ili produžnog kabela mora biti barem jednaka električnoj snazi aparata.
 - (2). Produžni kabel mora biti 3-žilni uzemljeni kabel.
 - (3). Dulji kabel se mora postaviti tako da ne pada preko radne ploče ili ploče stola gdje ga djeca mogu povući ili se slučajno spotaknuti o njega.

ČIŠĆENJE

Povedite računa da aparat iskopčate s napajanja.

1. Očistite unutarnjost pećnice nakon uporabe blago navlaženom krpom.
2. Očistite dodatke na uobičajen način sapunicom.
3. Okvir vrata, brtva i okolni dijelovi moraju se pažljivo očistiti mekom krpom kad se zaprljaju.
4. Nemojte koristiti jaka abrazivna sredstva za čišćenje ili oštre metalne strugače za čišćenje stakla na vratima pećnice jer oni mogu izgrebati površinu, što može dovesti do lomljenja stakla.
5. Savjet za čišćenje---Radi lakšeg čišćenja zidova unutarnjosti koje može dodirnuti hrana koja se kuha: Stavite polovicu limuna u činiju, dodajte 300 ml vode i zagrijavajte je na 100% mikrovalne snage 10 minuta. Obrišite pećnicu čistom, suhom krpom.

POSUĐE



OPREZ

Opasnost od fizičke ozljede:

Opasno je da bilo tko osim stručne osobe obavlja bilo kakvo servisiranje ili popravke koji obuhvaćaju uklanjanje poklopca koji štiti od izlaganja mikrovalnoj energiji. Pogledajte upute pod naslovom „**Materijali koji se mogu koristiti u mikrovalnoj pećnici**“ ili „**Materijali koji se ne mogu koristiti u mikrovalnoj pećnici**“

Određeno nemetalno posuđe može biti nesigurno za korištenje u mikrovalnoj pećnici. Ako ste u nedoumici, možete ispitati posudu o kojoj je riječ slijedeći postupak opisan u nastavku.

Test posude:

1. Napunite posudu sigurnu za uporabu u mikrovalnoj 1 šoljom vode (250 ml) pored posude o kojoj je riječ.
2. Kuhajte na maksimalnoj snazi 1 min.
3. Pažljivo napunite posudu. Ako je prazna posuda topla, nemojte je koristiti za kuhanje u mikrovalnoj pećnici.
4. Nemojte kuhati dulje od 1 min.

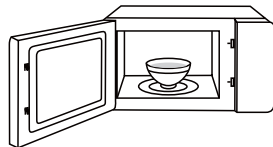





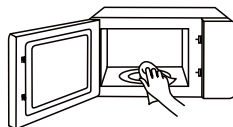











NAPOMENA

ODRŽAVATE UNUTARNJOST
I OBLAST USMJERIVAČA
VALOVA ČISTIM

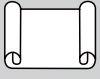

MATERIJALI KOJI SE MOGU KORISTITI U MIKROVALNOJ PEĆNICI

POSUĐE	NAPOMENE	
 Posuda za pečenje	Slijedite upute proizvođača. Dno posude za pečenje mora biti najmanje 5 mm iznad okretne ploče. Nepravilno korištenje može dovesti do lomljenja okretne ploče.	
 Posuđe za jelo	Samo siguran za uporabu u mikrovalnoj pećnici. Slijedite upute proizvođača. Ne koristiti naprslo ili okružano posuđe.	
 Staklenke	Uvijek skloniti poklopac. Koristiti samo za zagrijavanje hrane samo dok ne bude topla. Većina staklenki nije otporna na toplinu i mogu se polomiti.	
 Stakleno posuđe	Samo staklene posude za pečenje otporne na toplinu. Voditi računa da posuda bude bez metalnog premaza. Ne koristiti naprslo ili okružano posuđe.	
 Kese za kuhanje u pećnici	Slijedite upute proizvođača. Ne zatvarati metalnom vezicom. Napraviti proreze kako bi para mogla izaći.	
 Papirni tanjuri i čaše	Koristiti samo za kratkotrajno kuhanje/zagrijavanje. Ne ostavljajte pećnicu bez nadzora tijekom kuhanja.	
 Papirni ubrusi	Koristiti za pokrivanje hrane kod podgrijavanja i za upijanje masnoće. Koristiti uz nadzor samo za kratkotrajno kuhanje.	
 Pergament papir	Koristiti za pokrivanje kako bi se spriječilo prskanje ili umotati kod kuhanja na pari.	

MATERIJALI KOJI SE MOGU KORISTITI U MIKROVALNOJ PEĆNICI

POSUĐE

NAPOMENE



Plastika

Samo siguran za uporabu u mikrovalnoj pećnici. Slijediti upute proizvođača. Treba imati oznaku „Sigurno za mikrovalnu“. Neke plastične posude se razmekšaju kad se hrana u njima zagrije. „Kese za kuhanje“ i hermetički zatvorene plastične kese moraju se preseći, probušiti ili se na njima treba napraviti otvor prema uputama za odgovarajuću ambalažu.



Plastična folija

Samo siguran za uporabu u mikrovalnoj pećnici. Koristiti za pokrivanje hrane tijekom kuhanja kako bi se zadržala vlaga. Pazite da plastična folija ne dodiruje hranu.



Termometri

Samo sigurni za uporabu u mikrovalnoj pećnici (termometri za meso i slatkiše).



Voštani papir

Koristiti kao poklopac radi sprječavanja prskanja i zadržavanja vlage.



MATERIJALI KOJI SE NE MOGU KORISTITI U MIKROVALNOJ PEĆNICI

POSUDE

NAPOMENE



Aluminijska posuda

Može izazvati iskrenje. Prebacite hranu u posudu sigurnu za korištenje u mikrovalnoj pećnici.



Kartonska posuda za hranu s metalnom drškom

Može izazvati iskrenje. Prebacite hranu u posudu sigurnu za korištenje u mikrovalnoj pećnici.



Posuđe od metala ili s metalnim premazom

Metalni štiti hranu od mikrovalne energije. Metalni premaz može izazvati iskrenje.



Metalne uvrnute vezice

Može izazvati iskrenje i požar u pećnici.



Papirne vrećice

Može izazvati požar u pećnici.



Plastična pjena

Plastična pjena se može istopiti ili onečistiti tekućinu u unutarnjosti kad se izloži visokoj temperaturi.

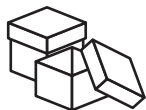

Drvo

Drvo će se osušiti kad se koristi u mikrovalnoj pećnici i može se podijeliti ili naprsnuti.



POSTAVLJANJE PROIZVODA

POSTAVLJANJE PEĆNICE

NAZIVI DIJELOVA MIKROVALNE PEĆNICE I DODATAKA

Izvadite pećnicu i sav materijal iz kutije i iz unutarnjosti pećnice.

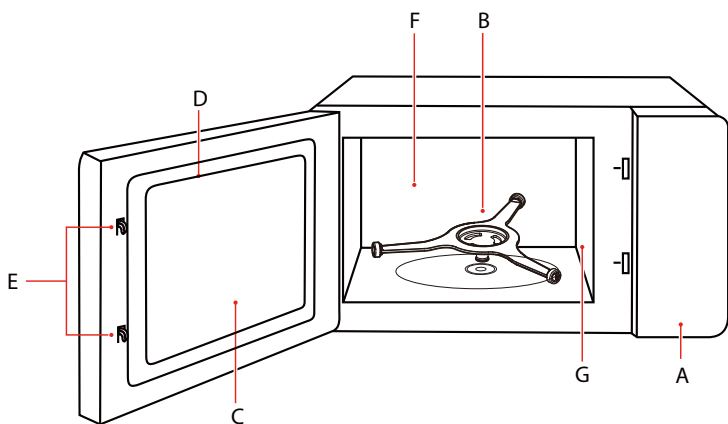
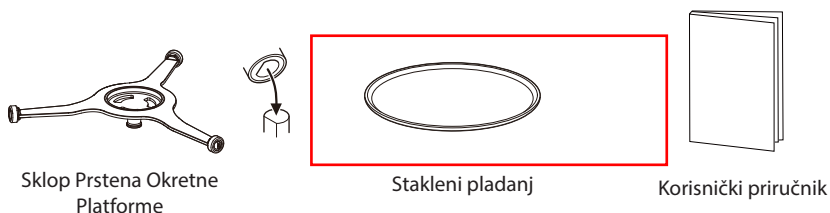

POSTAVLJANJE PEĆNICE

POSTAVLJANJE OKRETNE PLOČE

Čišćenje odjeljka za kuhanje i stavljanje okretne ploče na mjesto.

Kod postavljanja novih aparata, vodite računa da sva traka za pakiranje i transport bude uklonjena s osovine okretne ploče.

Prije korištenja aparata za pripremu hrane prvi put, morat ćete pravilno postaviti okrenu ploču. Morate očistiti odjeljak za kuhanje i dodatke.

Kako se okretna ploča stavlja na mjesto:

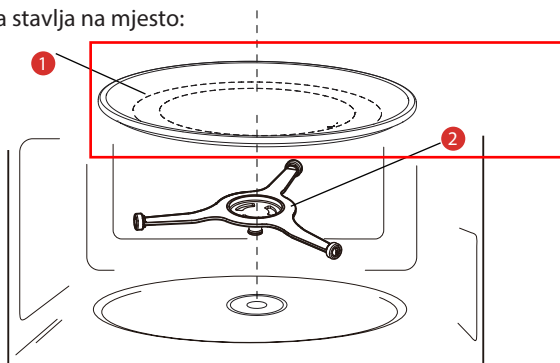

1) Stakleni pladanj

2) Sklop prstena okretne platforme

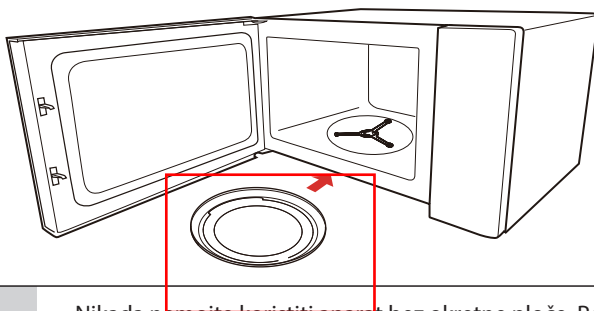

NAPOMENA

- Nikada nemojte koristiti aparat bez okretne ploče. Povedite računa da ona pravilno naliježe. Okretna ploča se može okretati u smjeru kretanja kazaljki na satu i suprotno od njega.
- Nikada nemojte postavljati stakleni plato naopako. Kretanje staklenog platoa nikada ne smije biti ograničeno.
- Prilikom kuhanja uvijek se moraju koristiti i stakleni plato i sklop prstena okretne ploče.
- Sva hrana i posude s hranom uvijek se stavljaju na stakleni plato radi kuhanja.
- Nikada nemojte ograničavati kretanje okretne ploče.
- Ako stakleni plato ili sklop prstena okretnog stola naprsne ili polomi, obratite se najbližem ovlaštenom servisnom centru.

POSTAVLJANJE NA RADNOM PULTU

Uklonite sav materijal za pakiranje i dodatke. Pregledajte ima li na pećnici oštećenja kao što su udubljenja ili neispravna vrata. Nemojte ugrađivati pećnicu ako je oštećena.

Unutarnjost: Uklonite svu zaštitnu foliju koju nađete na unutarnjim površinama pećnice.

Nemojte uklanjati svijetlosmeđi poklopac usmjerivača valova koji je pričvršćen u unutarnjosti pećnice radi zaštite magnetrona.

POSTAVLJANJE

1. Odaberite ravnu površinu koja osigurava dovoljno otvorenog prostora za ulazne i/ili izlazne ventilacijske otvore.
 - a. Minimalna visina ugradnje je 85 cm.
 - b. Stražnja površina aparata se mora postaviti uz zid. Ostavite minimalno rastojanje od 30 cm iznad pećnice. Između pećnice i susjednih zidova neophodno je minimalno rastojanje od 20 cm.
 - c. Nemojte uklanjati stopice s donje strane pećnice.
 - d. Blokiranje ulaznih i/ili izlaznih otvora može oštetiti pećnicu.
 - e. Postavite pećnicu što je moguće dalje od radio i TV aparata. Rad mikrovalne pećnice može izazvati smetnje u radio ili TV prijemu.

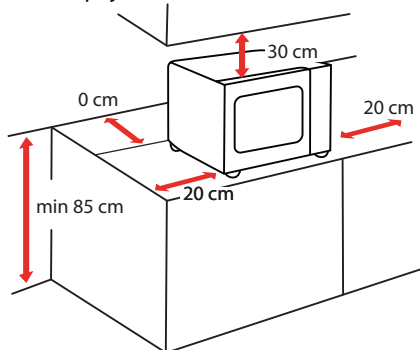

2. Priključite mikrovalnu pećnicu u standardnu utičnicu u domaćinstvu. Povedite računa da napon i frekvencija budu isti kao napon i frekvencija na nazivnoj naljepnici.



NAPOMENA

- Nemojte postavljati pećnicu iznad ploče za kuhanje ili drugog aparata koji proizvodi toplinu. Ako se postavi u blizini izvora topline, pećnica se može oštetiti i jamstvo može biti poništeno.

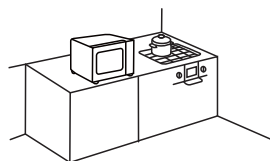

Dostupna površina može biti vruća tijekom rada

PRIJE PRVOG KORIŠTENJA

Aparat može stvarati neprijatan miris kad se koristi prvi put.

U ovom odjeljku je opisano što trebate uraditi prije korištenja mikrovalne pećnice za pripremu hrane prvi put. Najprije pročitajte upute pod naslovom „**VAŽNE UPUTE ZA SIGURNOST**“ na strani 3.

Da biste mogli koristiti nov aparat, morat ćete pravilno postaviti okretnu ploču na mjesto. Također morate očistiti odjeljak za kuhanje i dodatke.





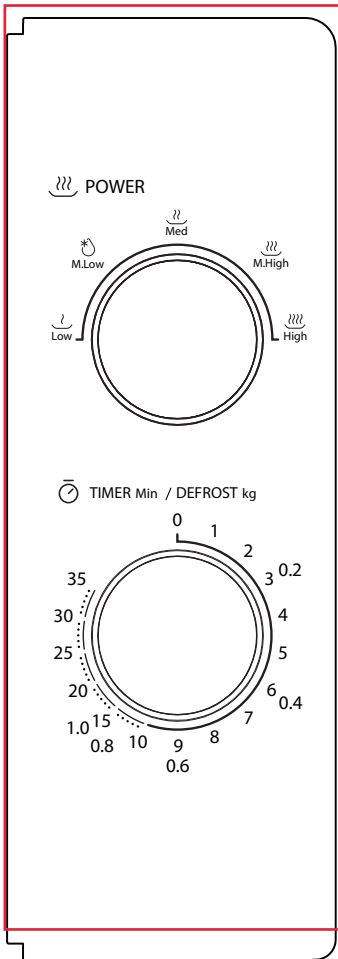

NAPOMENA

- Nikada nemojte koristiti aparat bez okretne ploče.
- Povedite računa da ona pravilno naliježe. Okretna ploča se može okretati u smjeru kretanja kazaljki na satu i suprotno od njega.

UKLOVANJE



1. Postavite snagu kuhanja tako što ćete gumb za snagu okrenuti na željenu razinu.
2. Postavite vrijeme kuhanja tako što ćete gumb brojača vremena okrenuti na željeno vrijeme prema smjernicama za kuhanje hrane koju spremate.
3. Mikrovalna pećnica će automatski započeti kuhanje nakon postavljanja razine snage i vremena.
4. Kad se vrijeme kuhanja završi, aparat će se zaustaviti uz zvučni signal.
5. Ako aparat nećete koristiti, uvijek postavite vrijeme na „0“.

Funkcija/snaga	Izlazna snaga	Primjena
	17% mikro.	Razmekšavanje sladoleda
	33% mikro.	Juha, paprikaš, omekšavanje maslaca ili odmrzavanje
	55% mikro.	Paprikaš, riba
	77% mikro.	Riža, riba, piletina, mljeveno meso
	100% mikro.	Podgrijavanje, mlijeko, kuhanje vode, povrće, napitak

Napomena: Prilikom vađenja hrane iz pećnice, povedite računa da pećnica bude isključena tako što ćete prekidač brojača vremena okrenuti u početni položaj.

Ako to ne uradite i koristite mikrovalnu pećnicu bez hrane u njoj, može doći do pregrijavanja i oštećenja magnetrona.

ČIŠĆENJE I ODRŽAVANJE

ČIŠĆENJE

Uz dobro održavanje i čišćenje, aparat će sačuvati svoj izgled i ostat će potpuno funkcionalan dugo vremena. Ovdje ćemo vam objasniti kako trebate pravilno održavati i čistiti svoj aparat.



UPOZORENJE

- Izgrebano staklo na vratima aparata može se pretvoriti u naprslinu. Nemojte koristiti stakleni strugač, oštre ili abrazivne alate za čišćenje ili deterdžente.
- Površina aparata se može oštetiti ako se čisti na odgovarajući način. Mikrovalna energija može izaći vani. Redovito čistite aparat i odmah uklonite sve ostatke hrane.
- Nemojte potapati aparat u vodu niti ga čistiti pod mlazom vode.

Sredstvo za čišćenje

Da se različite površine ne bi oštetile korištenjem pogrešnog sredstva za čišćenje, imajte u vidu niže navedene informacije. Temeljno operite spužvaste krpe prije uporabe.

Nemojte koristiti:



Jaka ili agresivna sredstva
za čišćenje



Metalni ili stakleni strugači
za čišćenje panela vrata



Metalni ili stakleni strugači
za čišćenje brtve vrata



Tvrđi jastučići ili
spužve za ribanje



Sredstva za čišćenje sa
visokim sadržajem alkohola

PREDNJA STRANA APARATA

Vruća sapunica:

Čistiti pomoću krpe sa suđe a zatim osušiti mekom krpom.
Ta čišćenje nemojte koristiti metalne ili staklene strugače.

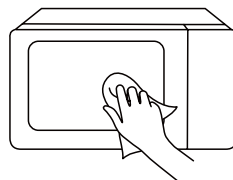

PREDNJA PLOČA APARATA

Vruća sapunica:

Čistiti pomoću krpe sa suđe a zatim osušiti mekom krpom. Odmah uklonite tragove prskanja i naslage krečnjaka, masti, skroba i albumina. Ispod tih naslaga i tragova od prskanja može nastati korozija. Za čišćenje nemojte koristiti sredstva za čišćenje stakla niti metalne ili staklene strugače.

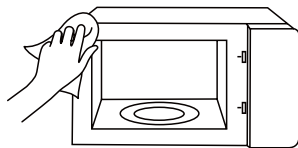

UNUTRAŠNOST APARATA

Vruća sapunica ili rastvor octa:

Čistiti pomoću krpe sa suđe a zatim osušiti mekom krpom. Nemojte koristiti sprej za pećnice ili neka druga agresivna sredstva za čišćenje ili abrazivne materijale. Žice za ribanje, abrazivne spužve i sredstva za čišćenje posuđa također nisu pogodna za uporaba. Ta sredstva grebu površinu. Sačekajte da se unutarne površine potpuno osuše.

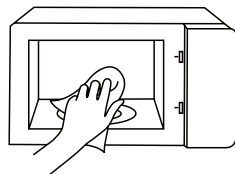

UDUBLJENJE U ODJELJKU ZA KUHANJE

Vlažna krpa:

Ne smije se dopustiti da voda uđe u aparat kroz okretnu ploču. Osušite okretnu ploču krpom.

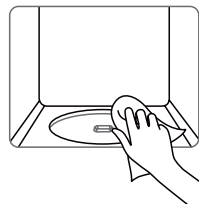

OKRETNNA PLOČA I PRSTEN VALJKA

Vruća sapunica:

Prilikom stavljanja okretne ploče u udubljenje, ona mora pravilno nalegnuti.



PANEL VRATA

Sredstvo za čišćenje stakla:

Čistiti krpom za suđe. Ne koristiti abrazivna sredstva za staklo.

ODRŽAVANJE

RJEŠAVANJE PROBLEMA

Isprobajte rješenja za svaki problem nakon što upotrijebite donju tablicu da provjerite svoj problem. Obratite se najbližem ovlaštenom servisu ako mikrovalna pećnica i dalje ne radi ispravno.

NEVOLJA	VJEROJATNI UZROK	MOGUĆE RJEŠENJE
Pećnica se ne pokreće	<ol style="list-style-type: none">Električni kabel pećnice nije uključen u utičnicu.Vrata su otvorena.Odabrana je neispravna operacija.	<ol style="list-style-type: none">Spojite u utičnicu.Zaključaj vrata i pokušaj još jednom.Provjerite upute
Zalučenje ili iskrenje	<ol style="list-style-type: none">Korišteni su predmeti koji se ne smiju koristiti u mikrovalnoj pećnici.Pećnica se koristi kada je prazna.Hrana koja se prolila ostaje u šupljini.	<ol style="list-style-type: none">Koristite samo posuđe koje je prikladno za mikrovalnu pećnicu.Nikada nemojte koristiti praznu pećnicu.Istrljajte karijes vlažnim ručnikom.
Neravnomjerno kuhana hrana	<ol style="list-style-type: none">Korišteni su predmeti koji se ne smiju koristiti u mikrovalnoj pećnici.Hrana nije u potpunosti odmrznuta.Razina snage je nedovoljna za vrijeme kuhanja.Obrok se ne okreće niti miješa.	<ol style="list-style-type: none">Koristite samo posuđe prikladno za mikrovalnu pećnicuU potpunosti odmrznite hranu.Koristite odgovarajuću snagu i vrijeme kuhanja.Promiješajte ili okrenite hranu.
Prekuhana hrana	Vrijeme kuhanja i razina snage su nedovoljni.	Koristite odgovarajuću snagu i vrijeme kuhanja.
Nedovoljno kuhana hrana	<ol style="list-style-type: none">Korišteni su predmeti koji se ne smiju koristiti u mikrovalnoj pećnici.Hrana nije u potpunosti odmrznuta.Ventilacijski otvori u pećnici su ograničeni.Vrijeme kuhanja i razina snage su neprikladni.	<ol style="list-style-type: none">Koristite samo posuđe koje je prikladno za mikrovalnu pećnicu.U potpunosti odmrznite hranu.Provjerite da ventilacijski otvori na pećnici nisu blokirani.Koristite odgovarajuće vrijeme kuhanja i razinu snage.
Neppravilno odmrzavanje	<ol style="list-style-type: none">Korišteni su predmeti koji se ne smiju koristiti u mikrovalnoj pećnici.Neodgovarajuća razina snage i vrijeme kuhanja.Bez okretanja ili ribanja hrane.	<ol style="list-style-type: none">Koristite samo posuđe prikladno za mikrovalnu pećnicu.koristite preporučeno vrijeme kuhanja i razinu snage.Bacati ili okretati hranu.



Prema Direktivi o otpadu od električne i elektroničke opreme (WEEE), WEEE treba skupljati i odlagati odvojeno. Ako ubuduće budete trebali odlagati ovaj proizvod, nemojte ga odlagati zajedno s kućnim otpadom. Molimo odnesite ovaj proizvod na sabirno mjesto WEEE gdje je dostupno.

#DetailsMatter

INSTRUKCIJU ROKASGRĀMATA

MIKROVIĻŅU KRĀSNS

MW-MM20P(BK)/MW-MM20P(WH)

Lūdzu, pirms lietošanas pārlasiet šo lietošanas pamācību.

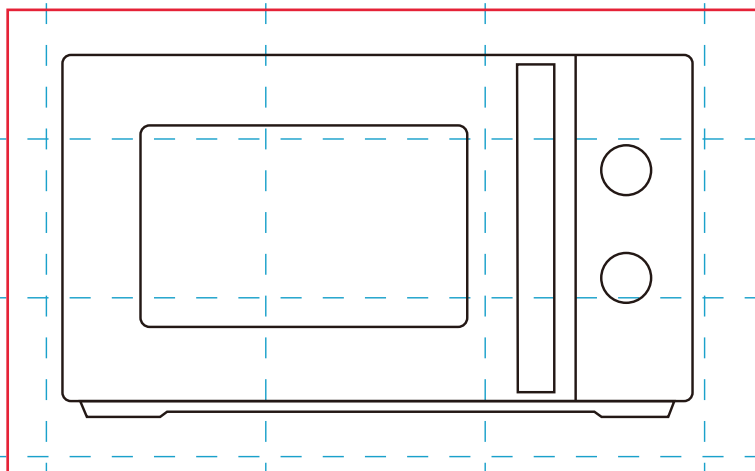

SATURS

PRODUKTA DROŠĪBA

Piesardzības pasākumi, lai izvairītos no iespējamās pārmērīgas mikroviļņu enerģijas iedarbības	LV-01
Svarīgi drošības norādījumi	LV-03
Lai samazinātu traumu risku cilvēkiem, saņemjiet iekārtu	LV-08
Galda piederumi	LV-11
Materiāli, ko var izmantot mikroviļņu krāsnī	LV-12
Materiāli, kurus nevar izmantot mikroviļņu krāsnī	LV-14

PRODUKTA IESTATĪJUMI

Krāsns iestatīšana	LV-15
Darbība	LV-20
TIRISANA	LV-22

APKOPE

Problēmu novēršana	LV-24
--------------------------	-------



PIEZĪME

PIRMS ŠĪ PRODUKTA EKSPLUATĀCIJAS, IZLASIET, SAPROTIET UN IEVĒROJIET ŠĪS INSTRUKCIJAS. NOTEIKTI SAGLABĀJIET ŠO ROKASGRĀMATU NĀKOTNES UZZIŅĀM.

PIESARDZĪBAS PASĀKUMI, LAI IZVĒRĪTOS NO IESPĒJAMĀS PĀRLIEKĀS MIKROVIĻŅU ENERĢIJAS IEDARBĪBAS

- (a). Nemēģiniet darbināt šo krāsni ar atvērtām durvīm, jo tas var izraisīt kaitīgu mikroviļņu enerģijas iedarbību. Ir svarīgi nesalauzt un nesabojāt drošības bloķētājus.
- (b). Nenovietojiet nekādus priekšmetus starp krāsni priekšējo virsmu un durvīm un neļaujiet netīrumiem vai tīrīšanas līdzekļa atlikumiem uzkrāties uz blīvējuma virsmām.
- (c). **BRĪDINĀJUMS:** Ja durvis vai durvju blīves ir bojātas, cepeškrāsni nedrīkst darbināt, kamēr to nav salabojusi kompetenta persona.

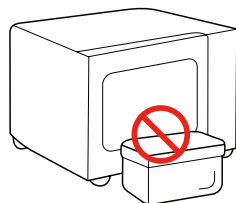

PAPILDINĀJUMS

Ja iekārta netiek uzturēta labā tīrības stāvoklī, tās virsma var tikt bojāta un ietekmēt ierīces kalpošanas laiku un izraisīt bīstamu situāciju.

SPECIFIKĀCIJAS

MODELIS	MW-MM20P(BK)/MW-MM20P(WH)
NOMINĀLAIS SPRIEGUMS/FREKVENCE	230-240V ~ 50Hz
NOMINĀLĀ IEVADES JAUDA (MIKROVIĻŅU)	1200-1270 W
NOMINĀLĀ IZEJAS JAUDA (MIKROVIĻŅU)	750-800 W



PIEZĪME

Visi attēli šajā rokasgrāmatā ir paredzēti tikai ilustratīviem nolūkiem; tie var nedaudz atšķirties no iegādātā aprīkojuma, lūdzu, skatiet faktisko produktu.

SVARĪGI DROŠĪBAS NORĀDĪJUMI



BRĪDINĀJUMS

Lai samazinātu ugunsgrēka, elektriskās strāvas trieciena, cilvēku savainojumu vai pārmērīgas mikroviļņu krāsns enerģijas iedarbības risku ierīces lietošanas laikā, ievērojiet pamata piesardzības pasākumus, tostarp šādus:



Izlasiet un ievērojiet konkrēto: **“PIESARDZĪBAS PASĀKUMI, LAI IZVĒRĪTOS NO IESPĒJAMĀS PĀRLIEKĀS MIKROVIĻŅU ENERĢIJAS IEDARBĪBAS”**.



Šo ierīci var lietot bērni no 8 gadu vecuma un personas ar ierobežotām fiziskām, sensoriskām vai garīgām spējām vai pieredzes un zināšanu trūkumu, ja viņi ir tikuši uzraudzīti vai ir instruēti par ierīces lietošanu drošā veidā un saprot saistītos riskus. Bērni nedrīkst spēlēt ar ierīci. Tīrīšanu un lietotāja apkopi nedrīkst veikt bērni bez uzraudzības.



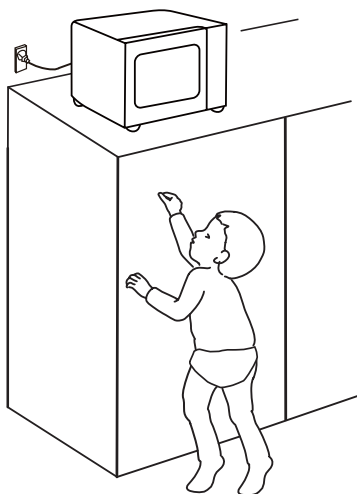

Glabājiet ierīci un tās vadu bērniem, kas jaunāki par 8 gadiem, nepieejamā vietā.





SVARĪGI DROŠĪBAS NORĀDĪJUMI

 Ja barošanas vads ir bojāts, tas jānomaina ražotājam, tā servisa aģentam vai līdzīgi kvalificētām personām, lai izvairītos no briesmām.

 **BRĪDINĀJUMS:** Pirms lampas nomaiņas pārlicinieties, vai ierīce ir izslēgta, lai izvairītos no elektriskās strāvas trieciena.

 **BRĪDINĀJUMS:** Ikvienam, kas nav kompetenta persona, ir bīstami veikt apkopes vai remonta darbības, kas ietver vāka noņemšanu, kas aizsargā pret mikroviļņu enerģijas iedarbību.

 **BRĪDINĀJUMS:** Šķidrumus un citus pārtikas produktus nedrīkst karsēt noslēgtos traukos, jo tie var eksplodēt.

 Sildot pārtiku plastmasas vai papīra traukos, uzmaniet cepeškrāni, jo pastāv aizdegšanās iespēja.



 Izmantojiet tikai tādus traukus, kas ir piemēroti lietošanai mikroviļņu krāsnīs.

 Ja izdalās dūmi, izslēdziet vai atvienojiet ierīci un turiet durvis aizvērtas, lai apslāpētu liesmas.

 Dzērienu karsēšana mikroviļņu krāsnī var izraisīt aizkavētu uzliesmojumu, tāpēc, rīkojoties ar trauku, jābūt uzmanīgiem.

 Lai izvairītos no apdegumiem, barošanas pudelišu un zīdaiņu pārtikas burciņu saturs pirms

SVARĪGI DROŠĪBAS NORĀDĪJUMI

lietošanas jāsamaisa vai jāsakrata un jāpārbauda temperatūra.

 Krāsns ir regulāri jātīra un jānoņem pārtikas nogulsnes. Lūdzu, saglabāiet viļņoto laukumu tīru. Izmantojiet mīkstu, mitru drānu, lai to notīrītu, ja uz viļņotās zonas vai kamerā ir izšļakstīti pārtikas atlikumi. Pārtikas atlikumu neiztīrīšana var izraisīt nekaitīgu dzirksteļošanu vai nelielu dūmu veidošanos mikroviļņu krāsnī, kā arī var mainīties kameras krāsa.

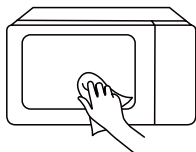

 Krāsns neuzturēšana tīrā stāvoklī var izraisīt virsmas nolietošanos, kas var negatīvi ietekmēt ierīces

kalpošanas laiku un, iespējams, izraisīt bīstamu situāciju.

 Izmantojiet tikai ieteicamo temperatūras zondi šai krāsnij. (krāsnīm, kas aprīkotas ar iespēju izmantot temperatūras zondi.)

 Mikroviļņu krāsns jādarbina ar atvērtām dekoratīvajām durvīm. (krāsnīm ar dekoratīvām durvīm.)

 Šī ierīce ir paredzēta lietošanai mājāsaimniecībā un līdzīgos pielietojumos, piemēram:

1. personāla virtuves zonas veikalos, birojos un citās darba vidēs;
2. klienti viesnīcās, moteļos un citās dzīvojamās telpās;
3. lauku mājas;

SVARĪGI DROŠĪBAS NORĀDĪJUMI

4. gultas un brokastu tipa vides.

 Mikroviļņu krāsns ir paredzēta ēdienu un dzērienu sildīšanai. Pārtikas vai apģērba žāvēšana un sildīšanas paliktņu, ielikņu, sūkļu, mitras drānas un tamlīdzīgu materiālu karsēšana var radīt savainojumu, aizdegšanās vai aizdegšanās risku.

 Ierīce ir paredzēta lietošanai brīvi stāvoša.

 Ierīču aizmugures virsma jānovieto pie sienas.

 Olas čaumalās un veselas cieti vārītas olas nedrīkst karsēt mikroviļņu krāsnī, jo tās var eksplodēt pat pēc tam, kad sildīšana mikroviļņu krāsnī ir beigusies.

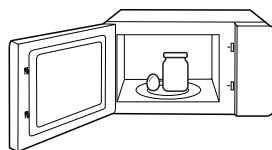

 Ierīci nedrīkst uzstādīt aiz dekoratīvām durvīm, lai izvairītos no pārkaršanas. (Tas neattiecas uz ierīcēm ar dekoratīvām durvīm.)

 Mikroviļņu krāsni nedrīkst ievietot skapī, izņemot, ja tā ir pārbaudīta skapī.

 Gatavošanas laikā mikroviļņu krāsni nav atļauts ievietot metāla traukus ēdieniem un dzērieniem.

 Ierīci nedrīkst tīrīt ar tvaika tīrītāju; gultas un brokastu tipa vidēs.

**UZMANĪGI IZLASIET UN SAGLABĀJIET
VĒLĀKAI UZZIŅAI**

LAI SAMAZINĀTU TRAUMU RISKU PERSONĀM, SAZEMĒJIET IEKĀRTU

Šai ierīcei jābūt iezemētai. Elektriskā īssavienojuma gadījumā zemējums samazina elektriskās strāvas trieciena risku, nodrošinot elektriskās strāvas novadišanas vadu.

Šī ierīce ir aprīkota ar kabeli ar zemējuma vadu un zemējuma kontaktdakšu. Kontaktdakšai jābūt pievienotai kontaktligzdai, kas ir pareizi uzstādīta un iezemēta.

BRĪDINĀJUMS — nepareiza zemējuma izmantošana var izraisīt elektriskās strāvas trieciena risku. Konsultējieties ar kvalificētu elektriķi vai servisa speciālistu, ja zemējuma norādījumi nav pilnībā izprasti vai ja rodas šaubas par to, vai ierīce ir pareizi iezemēta. Ja nepieciešams izmantot pagarinātāju, izmantojiet tikai 3 vadu pagarinātāju.



BĪSTAMI

Elektriskās strāvas trieciena risks:

Pieskaroties dažām iekšējām sastāvdaļām, var gūt nopietnus miesas bojājumus vai letālus ievainojumus. Neizjauciet šo ierīci.

LAI SAMAZINĀTU TRAUMU RISKU PERSONĀM, SAZEMĒJIET IEKĀRTU



BRĪDINĀJUMS

Elektriskās strāvas triecienu risks:

Nepareiza zemējuma izmantošana var izraisīt elektriskās strāvas triecienu. Nepievienojiet ierīci kontaktligzdai, kamēr ierīce nav pareizi uzstādīta un iezemēta.

1. Īss barošanas vads ir nodrošināts, lai samazinātu risku, kas var rasties, sapinoties garākā vadā vai pakļūpot aiz tā.
2. Ja tiek izmantots garš vads vai pagarinātājs:
 - (1). Marķētajai vadu komplekta vai pagarinātāja elektriskajai vērtībai ir jābūt vismaz tikpat lielai kā ierīces elektriskajai nominālajai vērtībai.
 - (2). Pagarinātājam ir jābūt zemējuma tipa 3 vadu kabelim.
 - (3). Garākais vads ir jāizkārto tā, lai tas nepārklājas pāri galda virsmai vai galda virsmai, kur bērni to var pavilkēt vai nejauši pakļūpt.

TĪRĪŠANA

Noteikti atvienojiet ierīci no strāvas padeves.

1. Pēc lietošanas iztīriet cepeškrāsns kameru ar nedaudz mitru drānu.
2. Piederumus tīriet parastajā veidā ziepjūdenī.
3. Durvju rāmis un blīve un blakus esošās daļas rūpīgi jānotīra ar mitru drānu, ja tās ir netīras.
4. Cepeškrāsns durvju stikla tīrīšanai neizmantojiet spēcīgus abrazīvus tīrīšanas līdzekļus vai asus metāla skrāpjus, jo tie var saskrāpēt virsmu, kā rezultātā stikls var saplīst.
5. Tīrīšanas padoms --- Lai vieglāk notīrītu kameras sienas, kurām var pieskarties pagatavotais ēdiens: levietojiet pusi citrona bļodā, pievienojiet 300 ml ūdens un 10 minūtes karsējiet ar 100% mikroviļņu jaudu. Noslaukiet cepeškrāsns tīru, izmantojot mīkstu, sausu drānu.

GALDA PIEDERUMI



UZMANĪBU

Personas savainojumu risks:
Ikvienam, kas nav kompetenta persona, ir bīstami veikt apkopes vai remonta darbības, kas ietver vāka noņemšanu, kas aizsargā pret mikroviļņu enerģijas iedarbību. Skatiet norādījumus sadaļā **“Materiāli, ko var izmantot mikroviļņu krāsnī”** vai **“Materiāli, ko nevar izmantot mikroviļņu krāsnī”**

Var būt daži nemetāliski trauki, kurus nav droši izmantot mikroviļņu krāsnī. Ja rodas šaubas, varat pārbaudīt attiecīgo trauku, veicot tālāk norādītās darbības.

Trauku pārbaude:

1. Piepildiet mikroviļņu krāsnī drošā traukā ar 1 glāzi auksta ūdens (250 ml) kopā ar attiecīgo trauku.
2. Gatavojiet ar maksimālo jaudu 1 min.
3. Uzmanīgi aptaustiet trauku. Ja tukšais trauks ir silts, neizmantojiet to gatavošanai mikroviļņu krāsnī.
4. Nepārsniedziet 1 minūti gatavošanas laiku.

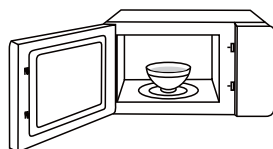

PIEZĪME

UZTURIET KAMERU UN
VIĻŅOTO ZONU TĪRU

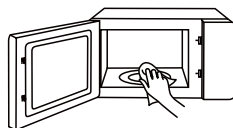

MATERIĀLI, KO VAR IZMANTOT MIKROVIĻŅU KRĀSNĪ

GALDA PIEDERUMI

PIEZĪMES



Brūnīnāšanas trauks

Izpildiet ražotāja norādījumus. Apbrūnīnāšanas trauka apakšai jābūt vismaz 5 mm virs grozāmās pamatnes. Nepareiza lietošana var izraisīt grozāmās pamatnes salūšanu.



Ēdienu trauki

Drošs tikai mikroviļņu krāsnī. Izpildiet ražotāja norādījumus. Neizmantojiet saplaisājušus vai iedrupušus traukus.



Stikla burkas

Vienmēr noņemiet vāku. Izmantojiet tikai, lai uzsildītu ēdienu, līdz tas ir silts. Lielākā daļa stikla burku nav karstumizturīgas un var saplīst.



Stikla trauki

Tikai karstumizturīgi cepeškrāsns stikla trauki. Pārliecinieties, vai nav metāla apdares. Neizmantojiet saplaisājušus vai iedrupušus traukus.



Cepeškrāsns gatavošanas maisiņi

Izpildiet ražotāja norādījumus. Neaizveriet ar metāla noslēgu. Izveidojiet iegriezumus, lai tvaiks varētu izplūst.



Papīra šķīvji un krūzes

Izmantojiet tikai īslaicīgai gatavošanai/sildīšanai. Gatavošanas laikā neatstājiet cepeškrāsni bez uzraudzības.



Papīra dvieļi

Izmantojiet, lai pārklātu pārtiku, lai uzsildītu un absorbētu taukus. Izmantojiet uzraudzībā tikai īslaicīgai gatavošanai.



Pergamenta papīra

Izmantojiet kā pārsegu, lai novērstu izšakstīšanos, vai aptinumu sautēšanai.



MATERIĀLI, KO VAR IZMANTOT MIKROVIĻŅU KRĀSNĪ

GALDA PIEDERUMI

PIEZĪMES



Plastmasa

Drošs tikai mikroviļņu krāsnī. Izpildiet ražotāja norādījumus. Jābūt marķētam "Drošs mikroviļņu krāsnī". Daži plastmasas trauki kļūst mīksti, ja iekšā esošais ēdiens kļūst karsts. "Vārīšanas maisi" un cieši noslēgti plastmasas maisiņi ir jāsgriež, jācaurdur vai jāvēdina, kā norādīts uz iepakojuma.



Plastmasas iesaiņojums

Drošs tikai mikroviļņu krāsnī. Izmantojiet, lai pārklātu ēdienu gatavošanas laikā, lai saglabātu mitrumu. Neļaujiet plastmasas iesaiņojumam pieskarties pārtikai.

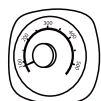

Termometri

Drošs tikai mikroviļņu krāsnī (gaļas un konfekšu termometri).



Vaska papīrs

Izmantojiet kā pārsegu, lai novērstu izšakstīšanos un saglabātu mitrumu.



MATERIĀLI, KO NEVAR IZMANTOT MIKROVIĻŅU KRĀSNĪ

GALDA PIEDERUMI

PIEZĪMES



Alumīnija paplāte

Var izraisīt loka veidošanos. Ievietojiet pārtiku mikroviļņu krāsnī drošā traukā.



Pārtikas kastīte ar metāla rokturi

Var izraisīt loka veidošanos. Ievietojiet pārtiku mikroviļņu krāsnī drošā traukā.



Metāla vai metāla apdares trauki

Metāls ekranē pārtiku no mikroviļņu enerģijas. Metāla apdare var izraisīt loka veidošanos.



Metāla savilces

Var izraisīt loku un var izraisīt aizdegšanos cepeškrāsnī.

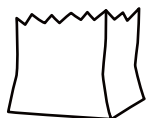

Papīra maisiņi

Var izraisīt aizdegšanos cepeškrāsnī.



Plastmasas putas

Plastmasas putas var izkausēt vai piesārņot iekšpusē esošo šķidrumu, pakļaujot to augstai temperatūrai.



Koksne

Koksne izžūš, kad to izmanto mikroviļņu krāsnī, un var plīst vai saplaisāt.



PRODUKTA IESTATĪJUMI

KRĀSNS IESTATĪŠANA

MIKROVIĻŅU KRĀSNS DAĻU UN PIEDERUMU NOSAUKUMS

Izņemiet krāsni un visus materiālus no kartona kārbas un cepeškrāsns kameras.

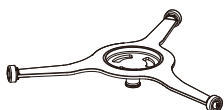

Grozāmās pamatnes
gredzena mezgls



Stikla paplāte Instrukciju rokasgrāmata

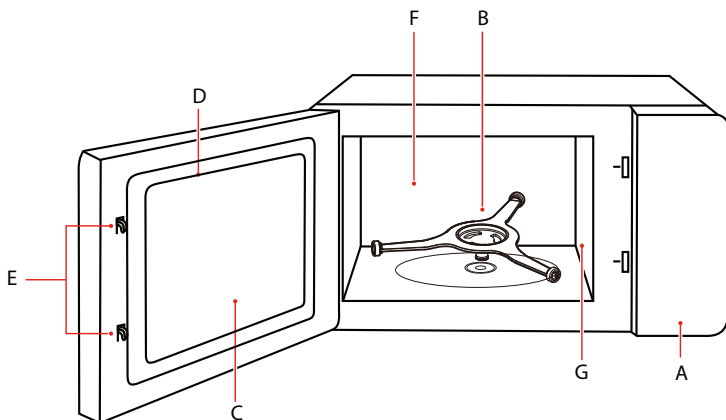
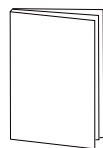

- A. Vadības panelis
- B. Grozāmās pamatnes
gredzena mezgls
- C. Novērošanas logs
- D. Durvju mezgls

- E. Drošības bloķēšanas sistēma
- F. Krāsns dobums
- G. Viļņvada vāks

KRĀSNS IESTATĪŠANA

GROZĪJAMĀS PAMATNES UZSTĀDĪŠANA

Gatavošanas kameras tīrīšana un grozāmās pamatnes novietošana vietā.

Jaunām iekārtām pārliecinieties, vai no grozāmās pamatnes vārpstas ir noņemta visa iepakojuma un transportēšanas lente.

Pirms lietojat ierīci ēdiena gatavošanai pirmo reizi, jums ir pareizi jānovieto grozāmā pamatne.

Jums ir jāiztīra gatavošanas kamera un piederumi.

Kā novietot grozāmo pamatni vietā:

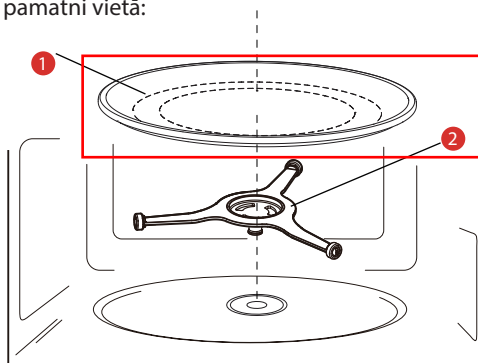

1) Stikla paplāte

2) Griešanas galds gredzena komplekts

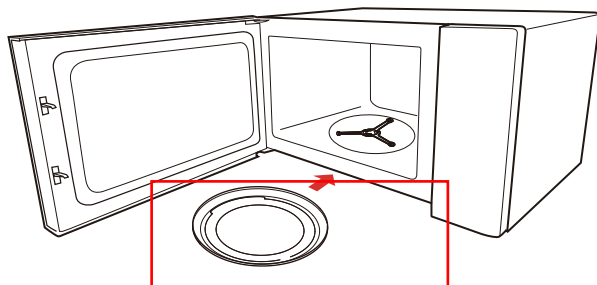

PIEZĪME

- Nekad neizmantojiet ierīci bez grozāmās pamatnes. Pārliecinieties, vai tā ir pareizi uzlikta. Grozāmā pamatne var griezties pulksteņrādītāja virzienā vai pretēji pulksteņrādītāja virzienam.
- Nekad nenovietojiet stikla paplāti otrādi. Stikla paplāte nekad nedrīkst būt ierobežota.
- Gatavošanas laikā vienmēr ir jāizmanto gan stikla paplāte, gan grozāmās pamatnes gredzens.
- Visi ēdieni un ēdiena trauki vienmēr tiek novietoti uz stikla paplātes gatavošanai.
- Nekad neierobežojiet grozāmās pamatnes kustību.
- Ja stikla paplāte vai grozāmā pamatnes gredzena mezgls saplaisā vai saplīst, sazinieties ar tuvāko pilnvaroto servisa centru.

KRĀSNS IESTATĪŠANA

ATDURU UZSTĀDĪŠANA

Noņemiet visus iepakojuma materiālus un piederumus. Pārbaudiet, vai cepeškrāsnij nav bojājumu, piemēram, iespaidumu vai salauztu durvju. Neuzstādiet, ja krāsns ir bojāta.

Korpuss: Noņemiet aizsargplēvi, kas atrodas uz mikroviļņu krāsns korpusa virsmas.

Nenoņemiet viļņvada vāciņu, kas ir pievienots cepeškrāsns kamerai, lai pasargātu magnetronu.

UZSTĀDĪŠANA

1. Izvēlieties līdzenu virsmu, kas nodrošina pietiekami daudz brīvas vietas ieplūdes un/vai izplūdes atverēm.
 - a. Minimālais uzstādīšanas augstums ir 85 cm.
 - b. Ierīces aizmugures virsma jānovieto pret sienu. Virs krāsns atstājiet vismaz 30 cm atstarpi. Starp krāsni un blakus esošajām sienām ir jābūt vismaz 20 cm.
 - c. Nenoņemiet kājiņas no krāsns apakšas.
 - d. Ieplūdes un/vai izplūdes atveru bloķēšana var sabojāt cepeškrāsni.
 - e. Novietojiet krāsni pēc iespējas tālāk no radio un TV.Mikroviļņu krāsns darbība var izraisīt radio vai TV uztveršanas traucējumus.

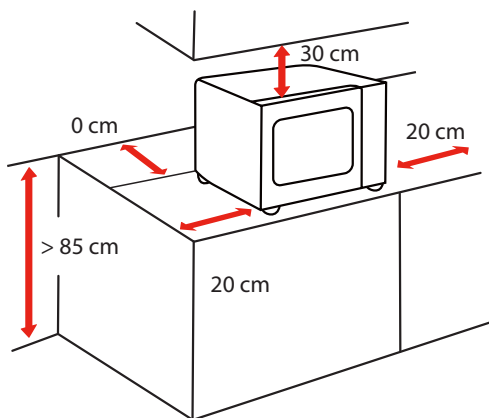

KRĀSNS IESTATĪŠANA

2. Pieslēdziet cepeškrāsni standarta mājsaimniecības kontaktligzdai. Pārļiecinieties, vai spriegums un frekvence ir tādi paši kā spriegums un frekvence, kas norādīta uz datu uzlīmes.



BRĪDINĀJUMS

- Neuzstādiet krāsni virs plīts virsmas vai citas siltumu radošas ierīces. Ja krāsns tiek uzstādīta tuvu siltuma avotam vai virs tā, tā var tikt bojāta, un garantija tiks anulēta.

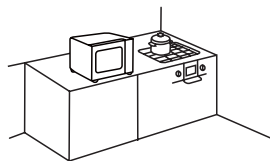

Pieejamā virsma darbības laikā var būt karsta.

LIETOŠANAS INSTRUKCIJA

PIRMS LIETOŠANAS PIRMO REIZI

Ierīce var radīt nepatīkamu smaku, kad to lieto pirmo reizi.

Šajā sadaļā ir norādīts, kas jums jādara, pirms lietojat mikroviļņu krāsni, lai pagatavotu ēdienu pirmo reizi. Iepriekš izlasiet sadaļu "**SVARĪGI DROŠĪBAS NORĀDĪJUMI**" 3. lappusē.

Lai varētu izmantot savu jauno ierīci, pareizi jānovieto grozāmā pamatne. Jātīra arī gatavošanas nodalījums un piederumi.



PIEZĪME

- Nekad neizmantojiet ierīci bez grozāmās pamatnes.
- Pārlicinieties, vai tā ir pareizi nofiksēta. Grozāmā pamatne var griezties pulksteņrādītāja virzienā vai pretēji pulksteņrādītāja virzienam.

DARBĪBA

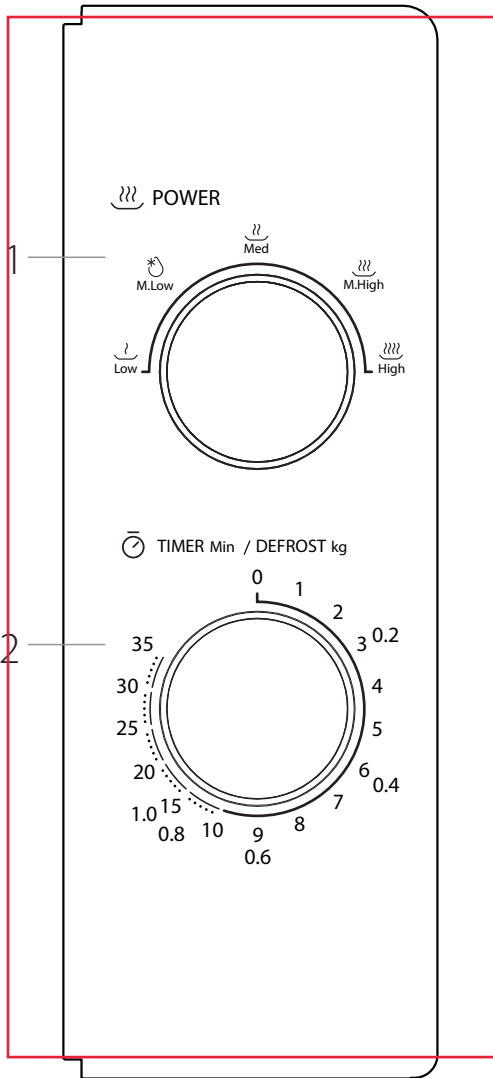

VADĪBAS PANELIS UN FUNKCIJAS



1. POWER ripa

2. TIMER ripa

- Lai iestatītu gatavošanas jaudu, pagriežot POWER ripu vēlamajā līmenī.
- Lai iestatītu gatavošanas laiku, pagriežot TIMER ripu līdz vajadzīgajam laikam saskaņā ar ēdiena gatavošanas rokasgrāmatu.
- Mikroviļņu krāsns automātiski sāks gatavot pēc jaudas līmeņa un laika iestatīšanas.
- Kad gatavošanas laiks ir beidzies, ierīce apstājas.
- Ja ierīce netiek lietota, vienmēr iestatiet laiku uz "0".

Funkcija/jauda	Jauda	Pielietojums
 Zems	17% mikro.	Mīkstināt saldējumu
 Vid. Zems	33% mikro.	Zupa, sautējums, mīkstina sviestu vai atkausē
 Vid.	55% mikro.	Sautējums, zivis
 Vid. Augsts	77% mikro.	Rīsi, zivis, vista, malta gaļa
 Augsts	100% mikro.	Uzsildīt, piens, uzvārit ūdeni, dārzeņi, dzērieni

Piezīme: Izņemot ēdienu no cepeškrāsns, lūdzu, pārlicinieties, vai cepeškrāsns barošana ir izslēgta, pagriežot taimera slēdzi uz 0 (nulle). Ja tas netiek darīts un mikroviļņu krāsns tiek darbināts bez ēdiena, tas var izraisīt pārkaršanu un magnetrona bojājumus.

TĪRĪŠANA

Labi kopjot un tīrot, jūsu ierīce saglabās savu izskatu un funkcionētspēju ilgu laiku. Šeit mēs paskaidrosim, kā pareizi kopt un tīrīt ierīci.



BRĪDINĀJUMS

- Ierīces durvju stikla skrāpējums var izveidoties par plaisu. Neizmantojiet stikla skrāpi, asus vai abrazīvus tīrīšanas līdzekļus vai mazgāšanas līdzekļus.
- Ierīces virsma var tikt bojāta, ja tā netiek pareizi tīrīta. Var izplūst mikroviļņu enerģija. Regulāri tīriet ierīci un nekavējoties noņemiet pārtikas paliekas.
- Neiegremdējiet ierīci ūdenī un netīriet to zem ūdens strūkļas.

Tīrīšanas līdzeklis

Lai nodrošinātu, ka dažādas virsmas netiek bojātas, izmantojot nepareizu tīrīšanas līdzekli, ievērojiet tālāk sniegto informāciju. Pirms lietošanas rūpīgi nomazgājiet jaunas sūkļa drānas.

Nelietojiet:



Agresīvi vai abrazīvie
tīrīšanas līdzekļi



Metāla vai stikla skrāpji
durvju paneļu tīrīšanai



Metāla vai stikla skrāpji
durvju blīvējuma tīrīšanai



Cieti beršanas
spilventiņi vai sūkļi



Tīrīšanas līdzekļi ar
augstu spirta saturu

IERĪCES PRIEKŠPUSE

Karsts ziepjūdens:

Notīriet, izmantojot trauku lupatiņu, un pēc tam nosusiniet ar mikstu drāniņu. Tīrīšanai neizmantojiet metāla vai stikla skrāpjus.

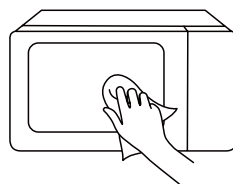

TĪRĪŠANA

IERĪCES PRIEKŠĒJĀ PLĀKSNE

Karsts ziepjūdens:

Notīriet, izmantojot trauku lupatiņu, un pēc tam nosusiniet ar mīkstu drāniņu.

Nekavējoties noņemiet kaļķakmens, tauku, cietes un organisko vielu šķakatas un plankumus. Zem šiem plankumiem vai šķakatām var veidoties korozija. Tīrīšanai neizmantojiet stikla tīrīšanas līdzekļus vai metāla vai stikla skrāpjus.

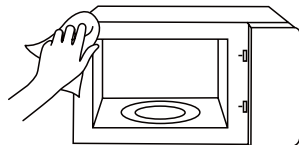

IERĪCES KAMERA

Karsts ziepjūdens vai etiķa šķīdums:

Notīriet, izmantojot trauku lupatiņu, un pēc tam nosusiniet ar mīkstu drāniņu. Neizmantojiet cepeškrāsns aerosolu vai citus agresīvus cepeškrāsns tīrīšanas līdzekļus vai abrazīvus materiālus. Nav piemēroti arī tīrīšanas spilventiņi, raupji sūkļi un pannu tīrīšanas līdzekļi. Šie priekšmeti saskrāpē virsmu. Ļaujiet iekšējām virsmām pilnībā nožūt.

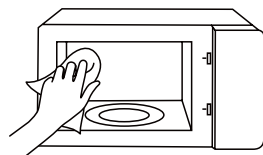

IEDOBE GATAVOŠANAS KAMERĀ

Mitra lupata:

Ūdenim nedrīkst ļaut iekļūst ierīcē caur grozāmās pamatnes piedziņu. Nosusiniet grozāmās pamatnes piedziņu ar drānu.

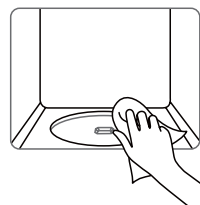

GROZĀMĀ PAMATNE UN GREDZENS

Karsts ziepjūdens:

Grozāmo pamatni padziļinājumā, tai ir pareizi jānofiksējas.



DURVJU PANELIS

Stikla tīrītājs:

Notīriet ar trauku lupatiņu. Neizmantojiet stikla skrāpjus.

APKOPE

PROBLĒMU NOVĒRŠANA

Pārbaudiet savu problēmu, izmantojot tālāk redzamo tabulu, un izmēģiniet katras problēmas risinājumus.

Ja mikroviļņu krāsns joprojām nedarbojas pareizi, sazinieties ar tuvāko pilnvaroto servisa centru.

PROBLĒMAS	IESPĒJAMĀS CĒĻONIS	IESPĒJAMS RISINĀJUMS
Cepeškrāsns nesāk darboties	<ol style="list-style-type: none">Cepeškrāsns elektrības vads nav pievienots.Durvis ir atvērtas.Iestatīta nepareiza darbība.	<ol style="list-style-type: none">Pieslēdziet kontaktligzdai.Aizveriet durvis un mēģiniet vēlreiz.Pārbaudiet instrukcijas
Loks vai dzirksteļošana	<ol style="list-style-type: none">Tika izmantoti materiāli, no kuriem mikroviļņu krāsni jāizvairās.Cepeškrāsns tiek darbināta, kad tā ir tukša.Izšļakstītās pārtikas paliekas kamerā.	<ol style="list-style-type: none">Izmantojiet tikai mikroviļņu krāsni piemērotus virtuves traukus.Nedarbiniet, ja krāsns ir tukša.Notīriet kameru ar mitru dvieli.
Nevienmērīgi pagatavoti ēdieni	<ol style="list-style-type: none">Tika izmantoti materiāli, no kuriem mikroviļņu krāsni jāizvairās.Pārtika nav pilnībā atkausēta.Gatavošanas laiks, jaudas līmenis nav piemērots.Ēdiens netiek apgriezts vai maisīts.	<ol style="list-style-type: none">Izmantojiet tikai mikroviļņu krāsni piemērotus virtuves traukus.Pilnībā atkausējiet pārtiku.Izmantojiet pareizo gatavošanas laiku, jaudas līmeni.Apgrieziet vai samaisiet ēdienu.
Pārgatavoti ēdieni	Gatavošanas laiks, jaudas līmenis nav piemērots.	Izmantojiet pareizo gatavošanas laiku, jaudas līmeni.
Nepietiekami termiski apstrādāti ēdieni	<ol style="list-style-type: none">Tika izmantoti materiāli, no kuriem mikroviļņu krāsni jāizvairās.Pārtika nav pilnībā atkausēta.Krāsns ventilācijas atveres ir ierobežotas.Gatavošanas laiks, jaudas līmenis nav piemērots.	<ol style="list-style-type: none">Izmantojiet tikai mikroviļņu krāsni piemērotus virtuves traukus.Pilnībā atkausējiet pārtiku.Pārbaudiet, vai krāsns ventilācijas atveres nav ierobežotas.Izmantojiet pareizo gatavošanas laiku, jaudas līmeni
Nepareiza atkausēšana	<ol style="list-style-type: none">Tika izmantoti materiāli, no kuriem mikroviļņu krāsni jāizvairās.Gatavošanas laiks, jaudas līmenis nav piemērots.Ēdiens netiek apgriezts vai maisīts.	<ol style="list-style-type: none">Izmantojiet tikai mikroviļņu krāsni piemērotus virtuves traukus.Izmantojiet pareizo gatavošanas laiku, jaudas līmeni.Apgrieziet vai samaisiet ēdienu.



Saskaņā ar elektrisko un elektronisko iekārtu atkritumu (EEIA) direktīvu EEIA jāsavāc un jāapstrādā atsevišķi. Ja nākotnē jums vajadzēs atbrīvoties no šī izstrādājuma, lūdzu, neizmetiet šo izstrādājumu kopā ar sadzīves atkritumiem. Lūdzu, nosūtiet šo produktu uz EEIA savākšanas punktiem, kur tie ir pieejami.



#DetailsMatter