

INSTRUCTION MANUAL

MICROWAVE OVEN

MW3-AC26SF(WH)

Please review this instruction manual before operating.

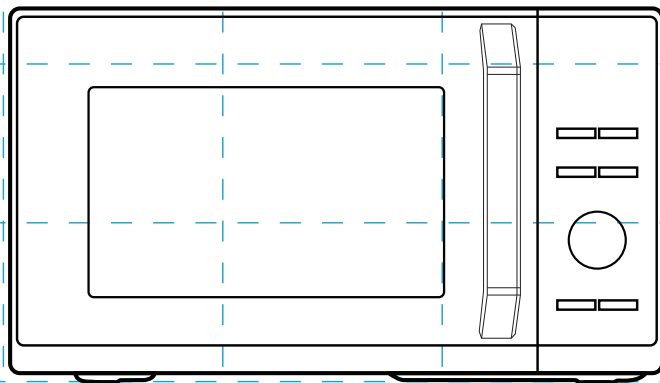

TOSHIBA

LANGUAGES

EN English

IT Italian

ES Spanish

EL Greece

PT Portugal

SR Serbia

BG Bulgaria

HR Croatia

LV Latvian

CONTENTS

PRODUCT SAFETY

Precautions to avoid possible exposure to excessive microwave energy	EN-01
Important safety instructions	EN-03
Grounding installation	EN-08
Cleaning	EN-10
Utensils.....	EN-11
Materials you can use in microwave oven	EN-12
Materials can not be used in microwave oven	EN-14

PRODUCT SETTING

Setting up your oven	EN-15
----------------------------	-------

INSTRUCTION FOR USE

Before using for the first time	EN-18
Operation	EN-19
1. Power levels	EN-20
2. Clock setting	EN-20
3. Kitchen timer	EN-21
4. Microwave cooking	EN-22
5. Grill or combination	EN-22
6. Convection with preheat	EN-23
7. Convection without preheat	EN-24
8. Airfry menu	EN-25
9. Auto menu&Crispy grill menu.....	EN-26
10. Weight defrost	EN-28
11. Time defrost	EN-28
12. Multi-stage cooking	EN-29

13. Speedy cooking	EN-30
14. Lock function	EN-31
15. Inquiring function.....	EN-31

CLEANING AND MAINTENANCE

Cleaning	EN-32
Trouble shooting	EN-34



NOTE

BEFORE OPERATING THIS PRODUCT, READ, UNDERSTAND, AND FOLLOW THESE INSTRUCTIONS. BE SURE TO SAVE THIS BOOKLIST FOR FUTURE REFERENCE.

PRODUCT SAFETY

PRECAUTIONS TO AVOID POSSIBLE EXPOSURE TO EXCESSIVE MICROWAVE ENERGY

- (a). Do not attempt to operate this oven with the door open since this can result in harmful exposure to microwave energy. It is important not to break or tamper with the safety interlocks.
- (b). Do not place any object between the oven front face and the door or allow soil or cleaner residue to accumulate on sealing surfaces.
- (c). **WARNING:** If the door or door seals are damaged, the oven must not be operated until it has been repaired by a competent person.

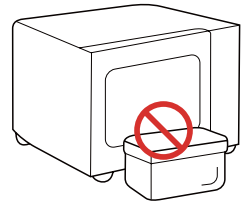

ADDENDUM

If the apparatus is not maintained in a good state of cleanliness, its surface could be degraded and affect the lifespan of the apparatus and lead to a dangerous situation.

SPECIFICATIONS

MODEL	MW3-AC26SF(WH)
RATED VOLTAGE/FREQUENCY	230-240 V~ 50 Hz
RATED INPUT POWER(MICROWAVE)	1450 W
RATED OUTPUT POWER(MICROWAVE)	900 W
RATED INPUT POWER(GRILL)	1000 W
RATED INPUT POWER(CONVECTION)	2100 W



NOTE

All pictures in this manual are for illustrative purposes only; these may be slightly different from the purchased equipment, please refer to the actual product.

IMPORTANT SAFETY INSTRUCTIONS



WARNING

To reduce the risk of fire, electric shock, injury to persons or exposure to excessive microwave oven energy when using your appliance, follow basic precautions, including the following:



Read and follow the specific: "**PRECAUTIONS TO AVOID POSSIBLE EXPOSURE TO EXCESSIVE MICROWAVE ENERGY**".



This appliance can be used by children aged from 8 years and above and persons with reduced physical, sensory or mental capabilities or lack of experience and knowledge if they have been given supervision or instruction concerning use of the appliance in a safe way and understand the hazards involved. Children shall not play with the appliance.



maintenance shall not be made by children without supervision.



Keep the appliance and its cord out of reach of children less than 8 years.





If the supply cord is damaged, it must be replaced by the manufacturer, its service agent or similarly qualified persons in order to avoid a hazard.



WARNING: Ensure that the appliance is switched off before replacing the lamp to avoid the possibility of electric shock.

IMPORTANT SAFETY INSTRUCTIONS

 **WARNING:** It is hazardous for anyone other than a competent person to carry out any service or repair operation that involves the removal of a cover which gives protection against exposure to microwave energy.

 **WARNING:** Liquids and other foods must not be heated in sealed containers since they are liable to explode.

 When heating food in plastic or paper containers, keep an eye on the oven due to the possibility of ignition.

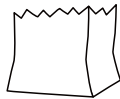

 Only use utensils that are suitable for use in microwave ovens.

 If smoke is emitted, switch off or unplug the appliance and keep the door closed in order to stifle any flames.

 Microwave heating of beverages can result in delayed eruptive boiling, therefore care must be taken when handling the container.

 The contents of feeding bottles and baby food jars shall be stirred or shaken and the temperature checked before consumption, in order to avoid burns.

 The oven should be cleaned regularly and any food deposits removed. Please keep the waveguide area clean. Use soft damp cloth to clean it up when there is food splash residue on the waveguide area or

IMPORTANT SAFETY INSTRUCTIONS

the cavity. Failure to clean food residue may cause innocuous sparking or some smoke in the microwave cavity, discoloration of the cavity may also occur.

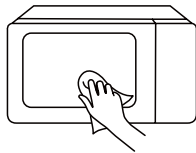

 Failure to maintain the oven in a clean condition could lead to deterioration of the surface that could adversely affect the life of the appliance and possibly result in a hazardous situation.

 Only use the temperature probe recommended for this oven. (for ovens provided with a facility to use a temperature-sensing probe.)

 The microwave oven must be operated with the decorative door open. (for ovens with a decorative door.)

 This appliance is intended to be used in household and similar applications such as:

1. staff kitchen areas in shops, offices and other working environments;
2. by clients in hotels, motels and other residential type environments;
3. farm houses;
4. bed and breakfast type environments.

 The microwave oven is intended for heating food and beverages. Drying of food or clothing and heating of warming pads, slippers, sponges, damp cloth and similar may lead to risk of injury, ignition or fire.

IMPORTANT SAFETY INSTRUCTIONS

 The appliance is intended to be used freestanding.

 The rear surface of appliances shall be placed against a wall.

 The temperature of accessible surfaces may be high when the appliance is operating.

 **WARNING:** When the appliance is operated in the combination mode, children should only use the oven under adult supervision due to the temperatures generated.

 Eggs in their shell and whole hard-boiled eggs should not be heated in microwave ovens since they may explode, even after microwave heating

has ended.

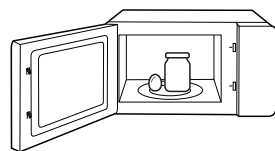

 The appliance must not be installed behind a decorative door in order to avoid overheating. (This is not applicable for appliances with decorative door.)

 The microwave oven shall not be placed in a cabinet unless it has been tested in a cabinet.

 Metallic containers for food and beverages are not allowed during microwave cooking.

 The appliance shall not be cleaned with a steam cleaner.

IMPORTANT SAFETY INSTRUCTIONS



The appliances are not intended to be operated by means of an external timer or separate remote-control system.

READ CAREFULLY AND KEEP FOR
FUTURE REFERENCE

TO REDUCE THE RISK OF INJURY TO PERSONS GROUNDING INSTALLATION

This appliance must be grounded. In the event of an electrical short circuit, grounding reduces the risk of electric shock by providing an escape wire for the electric current.

This appliance is equipped with a cord having a grounding wire with a grounding plug. The plug must be plugged into an outlet that is properly installed and grounded.

WARNING - Improper use of the grounding can result in a risk of electric shock. Consult a qualified electrician or serviceman if the grounding instructions are not completely understood or if doubt exists as to whether the appliance is properly grounded.

If it is necessary to use an extension cord, use only a 3-wire extension cord.



DANGER

Electric Shock Hazard:

Touching some of the internal components can cause serious personal injury or death. Do not disassemble this appliance.

TO REDUCE THE RISK OF INJURY TO PERSONS GROUNDING INSTALLATION



WARNING

Electric Shock Hazard:

Improper use of the grounding can result in electric shock. Do not plug into an outlet until appliance is properly installed and grounded.

1. A short power-supply cord is provided to reduce the risks resulting from becoming entangled in or tripping over a longer cord.
2. If a long cord or extension cord is used:
 - (1). The marked electrical rating of the cord set or extension cord should be at least as great as the electrical rating of the appliance.
 - (2). The extension cord must be a grounding-type 3-wire cord.
 - (3). The longer cord should be arranged so that it will not drape over the counter top or tabletop where it can be pulled on by children or tripped over unintentionally.

CLEANING

Be sure to unplug the appliance from the power supply.

1. Clean the cavity of the oven after using with a slightly damp cloth.
2. Clean the accessories in the usual way in soapy water.
3. The door frame and seal and neighbouring parts must be cleaned carefully with a damp cloth when they are dirty.
4. Do not use harsh abrasive cleaners or sharp metal scrapers to clean the oven door glass since they can scratch the surface, which may result in shattering of the glass.
5. Cleaning Tip---For easier cleaning of the cavity walls that the food cooked can touch: Place half a lemon in a bowl, add 300ml (1/2 pint) water and heat on 100% microwave power for 10 minutes. Wipe the oven clean using a soft, dry cloth.

UTENSILS



CAUTION

Personal Injury Hazard:

It is hazardous for anyone other than a competent person to carry out any service or repair operation that involves the removal of a cover which gives protection against exposure to microwave energy. See the instructions on "**Materials you can use in microwave oven**" or "**Materials can not be used in microwave oven**"

There may be certain non-metallic utensils that are not safe to use for microwaving. If in doubt, you can test the utensil in question following the procedure below.

Utensil Test:

1. Fill a microwave-safe container with 1 cup of cold water (250ml) along with the utensil in question.
2. Cook on maximum power for 1 min.
3. Carefully feel the utensil. If the empty utensil is warm, do not use it for microwave cooking.
4. Do not exceed 1 min cooking time.

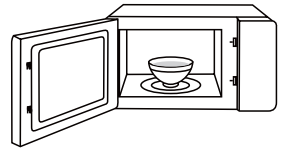





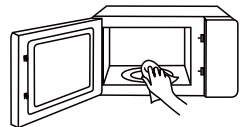











NOTE









KEEP THE CAVITY AND WAVEGUIDE AREA CLEAN

















MATERIALS YOU CAN USE IN MICROWAVE OVEN

UTENSILS	REMARKS
 Browning dish	Follow manufacturer's instructions. The bottom of browning dish must be at least 3/16 inch (5mm) above the turntable. Incorrect usage may cause the turntable to break. 
 Dinnerware	Microwave-safe only. Follow manufacturer's instructions. Do not use cracked or chipped dishes. 
 Glass jars	Always remove lid. Use only to heat food until just warm. Most glass jars are not heat resistant and may break. 
 Glassware	Heat-resistant oven glassware only. Make sure there is no metallic trim. Do not use cracked or chipped dishes. 
 Oven cooking bags	Follow manufacturer's instructions. Do not close with metal tie. Make slits to allow steam to escape. 
 Paper plates and cups	Use for short-term cooking/warming only. Do not leave oven unattended while cooking. 
 Paper towels	Use to cover food for reheating and absorbing fat. Use with supervision for a short-term cooking only. 
 Parchment paper	Use as a cover to prevent splattering or a wrap for steaming. 

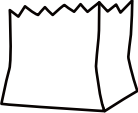
MATERIALS YOU CAN USE IN MICROWAVE OVEN

UTENSILS	REMARKS
 <p data-bbox="179 451 243 475">Plastic</p>	<p data-bbox="355 352 904 491">Microwave-safe only. Follow the manufacturer's instructions. Should be labeled "Microwave Safe". Some plastic containers soften, as the food inside gets hot. "Boiling bags" and tightly closed plastic bags should be slit, pierced or vented as directed by package.</p> 
 <p data-bbox="150 635 268 659">Plastic wrap</p>	<p data-bbox="355 555 904 635">Microwave-safe only. Use to cover food during cooking to retain moisture. Do not allow plastic wrap to touch food.</p> 
 <p data-bbox="137 799 285 823">Thermometers</p>	<p data-bbox="355 746 893 770">Microwave-safe only (meat and candy thermometers).</p> 
 <p data-bbox="159 962 263 986">Wax paper</p>	<p data-bbox="355 898 825 946">Use as a cover to prevent splattering and retain moisture.</p> 

MATERIALS CAN NOT BE USED IN MICROWAVE OVEN

UTENSILS	REMARKS
 Aluminum tray	May cause arcing. Transfer food into microwave-safe dish. 
 Food carton with metal handle	May cause arcing. Transfer food into microwave-safe dish. 
 Metal or metal trimmed utensils	Metal shields the food from microwave energy. Metal trim may cause arcing. 
 Metal twist ties	May cause arcing and could cause a fire in the oven. 
 Paper bags	May cause a fire in the oven. 
 Plastic foam	Plastic foam may melt or contaminate the liquid inside when exposed to high temperature. 
 Wood	Wood will dry out when used in the microwave oven and may split or crack. 

PRODUCT SETTING

SETTING UP YOUR OVEN

(In case of any differences between the appliance and the pictures in this manual, the product shall prevail.)

NAMES OF MICROWAVE OVEN PARTS AND ACCESSORIES

Remove the oven and all materials from the carton and oven cavity.

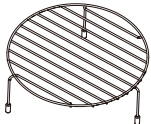

Higher Grill Rack

~~Grill Rack (Cannot be used in microwave function and must be placed on the glass tray)~~

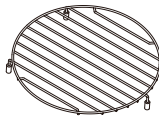

Lower Grill Rack

~~Grill Rack (Cannot be used in microwave function and must be placed on the glass tray)~~

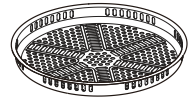

Bake Tray (Cannot be used in conjunction with microwave function and can be placed on the grill rack)



Glass Tray

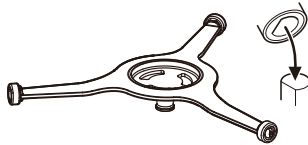

Turntable Ring Assembly



Instruction Manual

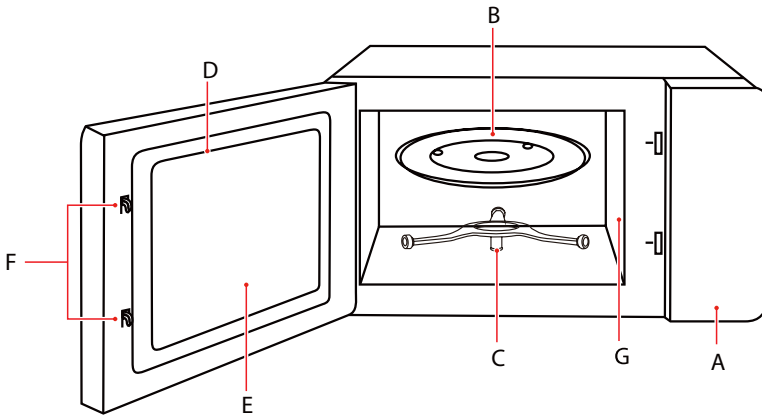

A) Control panel

B) Glass tray

C) Turntable ring assembly

D) Door assembly

E) Observation window

F) Safety interlock system

G) Waveguide cover

SETTING UP YOUR OVEN

TURNTABLE INSTALLATION

Clean the cooking compartment and place the turntable.

For new installations, make sure all packaging and shipping tape has been removed from the turntable shaft.

Before using the appliance to prepare food for the first time, you will need to put the turntable in place correctly. You must clean the cooking compartment and accessories. You can also refer them to the cleaning section.

How to put the turntable in place:

1. Place the turntable ring assembly ② into the recess in the cooking compartment.
2. Place the glass tray ① on the turntable ring assemblies ②.

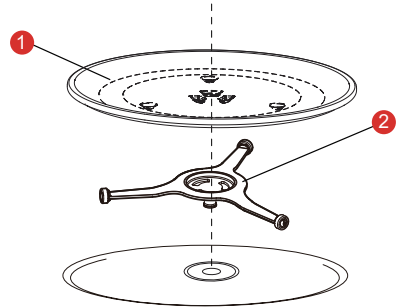

- 1) Glass Tray
2) Turntable Ring Assembly

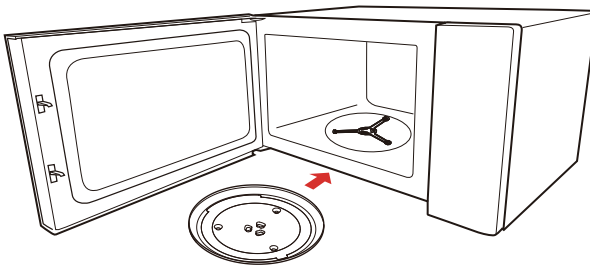

NOTE

- Never use the appliance without the turntable. Make sure that it is properly engaged. The turntable can turn clockwise or anti-clockwise.
- Never place the glass tray upside down. The glass tray should never be restricted.
- Both glass tray and turntable ring assembly must always be used during cooking.
- All food and containers of food are always placed on the glass tray for cooking.
- Never restrict the movement of the turntable.
- If glass tray or turntable ring assembly cracks or breaks, contact your nearest authorized service center.

COUNTERTOP INSTALLATION

Remove all packing material and accessories. Examine the oven for any damage such as dents or broken door. Do not install if oven is damaged.

Cabinet: Remove any protective film found on the microwave oven cabinet surface. Do not remove the waveguide cover that is attached to the oven cavity to protect the magnetron.

INSTALLATION

1. Select a level surface that provide enough open space for the intake and/or outlet vents.
 - a. The minimum installation height is 85cm.
 - b. The rear surface of appliance shall be placed against a wall. Leave a minimum clearance of 30cm above the oven. A minimum clearance of 20cm is required between the oven and any adjacent walls.
 - c. Do not remove the legs from the bottom of the oven.
 - d. Blocking the intake and/or outlet openings can damage the oven.
 - e. Place the oven as far away from radios and TV as possible. Operation of microwave oven may cause interference to your radio or TV reception.

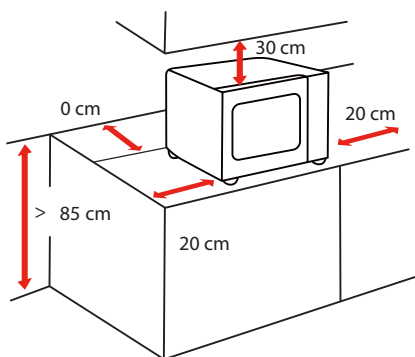

2. Plug microwave oven into a standard household outlet. Be sure the voltage and the frequency is the same as the voltage and the frequency on the rating label.



NOTE

- Do not install oven over a range cooktop or other heat-producing appliance. If installed near or over a heat source, the oven could be damaged and the warranty would be void.

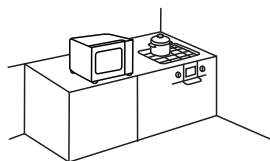

The accessible surface may be hot during operation

INSTRUCTION FOR USE

BEFORE USING FOR THE FIRST TIME

It is normal that the oven may produce unpleasant odors when it is used for the first time.

This section tells you what you need to do before using your microwave to prepare food for the first time. Read the section entitled "**PRODUCT SAFETY**" beforehand.

Before you can use your new appliance, you will need to put the turntable in place correctly. You must also clean the cooking compartment and accessories.



NOTE

- Never use the appliance without the turntable.
- Make sure that it is properly engaged. The turntable can turn clockwise or anti-clockwise.

OPERATION

CONTROL PANEL AND FEATURES

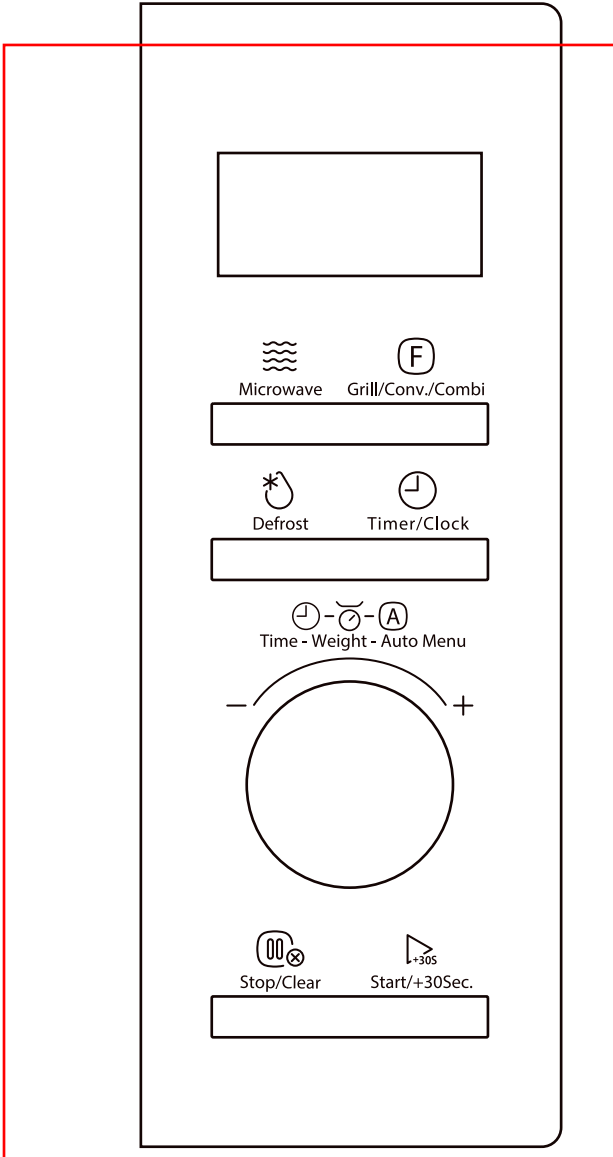

1. POWER LEVELS

Five power levels are available.

LEVEL	POWER	DISPLAY
1	100%	P100
2	80%	P80
3	50%	P50
4	30%	P30
5	10%	P10

2. CLOCK SETTING

When the microwave oven is plugged into an outlet, "0:00" will display.

a Press  twice, 00:00 displays.



b Turn the knob to set the hour figures, it should be within 0-23.

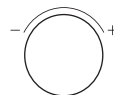



c Press  or  to confirm the hour figures.

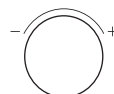

d Turn the knob to set the minute figures, it should be within 0-59.



e Press  Start/+30Sec. or  Timer/Clock to confirm.



NOTE

- When the oven is power on, if the clock is not be set, it will not work.
- In the process of setting clock, if there is not any operation in 5 minutes or press  directly, display will automatically return to the previous clock setting.

3. KITCHEN TIMER

When the microwave oven is plugged into an outlet, "0:00" will display.

a Press  once



b Turn the knob to set the time, it should be within 0:05-95:00.



c Press  Start/+30Sec. to start counting down





NOTE

- The Kitchen Timer setting is different from the Clock setting; it is simply a timer.
- During the Kitchen Timer function, no cooking function can be set into operation.

4. MICROWAVE COOK

When the microwave oven is plugged into an outlet, "0:00" will display.

- a** or
- Press  more times to choose the power level.
- Press  once, and then turn the knob to set the power level



- b** Press  to confirm the power level.



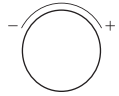

- c** Turn the knob to set the time, the maximum time value is "95:00".



- d** Press  to start cooking.



5. GRILL OR COMBINATION

- a** or
- Press  more times to choose the mode.
- Press  once, and then turn the knob to choose the mode.



"G-1,C-1...C-4,150°C,160°C.....240°C" will display in order. ("G-1" is grill, "C-1~C-4" are combination).

b Press  to confirm the mode.



c Turn the knob to set the time, the maximum time value is "95:00".

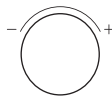

d Press  to start cooking.



NOTE

- When half of the time has finished, the buzzer will sound to remind you to turn the food over during grill function. If no operation, the oven will continue working.

6. CONVECTION WITH PREHEAT

Press  more times to choose the convection temperature..



a or

Press  once, and then turn the knob to choose the convection temperature.



150C, 160C.....240C are available.

b Press  twice to start preheating. When preheating is completed, the temperature will flash, open the door and place food in the oven.



c Turn the knob to set the time, the maximum time value is "95:00".

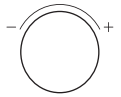

d Press  to start cooking.

Start/+30Sec.





7. CONVECTION WITHOUT PREHEAT

a Press  more times to choose the convection temperature.

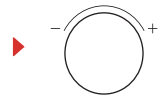

a or Press  once, and then turn the knob to choose the convection temperature. 150°C, 160°C.....240°C are available.



b Press  to confirm the temperature.

Start/+30Sec.



c Turn the knob to set the time, the maximum time value is "95:00".

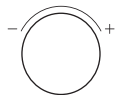

d Press  to start cooking.

Start/+30Sec.



8. AIRFRY MENU

- a** In waiting state, turn the knob right to enter the menu function.
Turn the knob repeatedly to choose the menu type H-1.

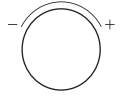

- b** Press  Start/+30Sec. to confirm the type of menu



- c** Turn the knob to choose the submenu.

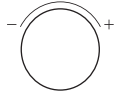

- d** Press  Start/+30Sec. to start cooking



AIRFRY MENU CHART

DISPLAY	MENU	WEIGHT
H - 1	Frozen French fries	300g
H - 2	Frozen Potato croquettes	350g
H - 3	Frozen Squid	250g
H - 4	Frozen Onion rings	250g
H - 5	Frozen chicken nuggets	350g
H - 6	Escalope	400g
H - 7	Shrimps	250g
H - 8	Vegetable	200g
H - 9	Spring rolls	300g

Note: The weight of the airfry menu cannot be set.

9. AUTO MENU & CRISPY GRILL MENU

a In waiting state, turn the knob right to enter the menu function.
Turn the knob repeatedly to choose auto menu(display A-1)or
crispy grill menu(display C-1).For example,choose the C-1.

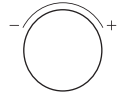

b Press  to confirm.
Start/+30Sec.



c Turn the knob to choose the submenu,
C-1~C-4 are available.

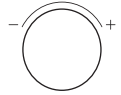

d Press  to confirm.
Turn the knob to choose the weight
The weight of C-3 and C-4 cannot be set.

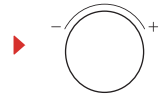

e Press  to confirm.
Start/+30Sec.



CRISPY GRILL MENU CHART

DISPLAY	MENU	WEIGHT
C-1	Cordon bleu	300g
		600g
		900g
C-2	lasagna	200g
		300g
		400g
		500g
C-3	bread	100g
C-4	pie/tart	8 (about 350g)

AUTO MENU CHART

MENU	DISPLAY	WEIGHT/ AMOUNT	POWER LEVEL
A-1 AUTO REHEAT	150g	150g	P100
	250g	250g	
	350g	350g	
	450g	450g	
	600g	600g	
A-2 POTATO	1	1(about 230g)	P100
	2	2	
	3	3	
A-3 MEAT	150g	150g	P80
	300g	300g	
	450g	450g	
	600g	600g	
A-4 VEGETABLE	150g	150g	P100
	350g	350g	
	500g	500g	
A-5 FISH	150g	150g	P80
	250g	250g	
	350g	350g	
	450g	450g	
	650g	650g	
A-6 PASTA	50g(with cold water 450g)	50g	P80
	100g(with cold water 800g)	100g	
	150g(with cold water 1200g)	150g	
A-7 SOUP	200g	200g	P100
	400g	400g	
	600g	600g	
A-8 CAKE	475g	475g	CONVEC.160°C (With preheat160°C)
A-9 PIZZA	100g	100g	C-4
	200g	200g	
	300g	300g	
A-10 CHICKEN	500g	500g	C-4
	750g	750g	
	1000g	1000g	
	1200g	1200g	

10.WEIGHT DEFROST

- a Press  once, "dEF1" will display.



- b Turn the knob to set the weight of food, it should be within "100g-2000g".

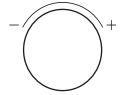

- c Press  to start defrosting.



NOTE

- The buzzer will sound twice to remain you of turning over the food during defrosting.

11 .TIME DEFROST

- a Press  twice, "dEF2" will display.



- b Turn the knob to set the time, the maximum time value is "95:00".

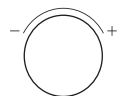

c Press  Start/+30Sec. to start defrosting.



Start/+30Sec.



NOTE

- The buzzer will sound to remind you of turning over the food when half of the time has passed.
- The default power level is P30, it can not be changed.

12. MULTI-SATGE COOKING

a Press  Defrost twice, "dEF2" will display.

Defrost

b Turn the knob to set the time, the maximum time value is "95:00".

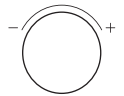

c Press  Grill/Conv./Combi to choose the cooking mode.

Grill/Conv./Combi

d Press  Start/+30Sec. to confirm.

Start/+30Sec.

e Turn the knob to set the time, the maximum time value is "95:00".

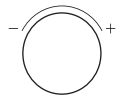

f Press  to start cooking.

Start/+30Sec.

Start/+30Sec.



NOTE

- Two cooking stages can be set in multi-stage cooking.
- If you set defrost function, it will work automatically in the first stage.
- Kitchen Timer, Auto menu, Speed cooking and Preheat cannot be set as one of the multi-stage.

13. SPEED COOKING

a Turn the knob left once to choose the cooking mode with 100% power level for 5 seconds directly.

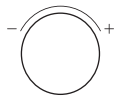

b Turn the knob to set the time, the maximum time value is "95:00".

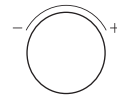

c Press  to start cooking.

Start/+30Sec.



Start/+30Sec.

a Press  once to cook with 100% power level with 30 seconds directly.

Start/+30Sec.

Start/+30Sec.

14. LOCK FUNCTION

- a** To lock the microwave so that it cannot be operated by children or other unintended users, press  pad for 3 seconds, the locked icon will display.



- b** To unlock, press  pad for 3 seconds.



15. INQUIRING FUNCTION

- a** When oven is cooking, press  , the current time will appear for three seconds in the display.



CLEANING AND MAINTENANCE

CLEANING

With good care and cleaning, your appliance will retain its appearance and remain fully functioning for a long time to come. We will explain here how you should correctly care for and clean your appliance.



WARNING

- Scratched glass in the appliance door may develop into a crack. Do not use a glass scraper, sharp or abrasive cleaning aids or detergents.
- The surface of the appliance may become damaged if it is not cleaned properly. Microwave energy may escape. Clean the appliance on a regular basis, and remove any food remnants immediately.
- Do not immerse the appliance in water or clean under a jet of water.

Cleaning agent

To ensure that the different surfaces are not damaged by using the wrong cleaning agent, observe the information in the table. Wash new sponge cloths thoroughly before use.

Do not use:



Harsh or abrasive cleaning agents



Metal or glass scrapers to clean the door panels



Metal or glass scrapers to clean the door seal



Hard scouring pads or sponges



Cleaning agents with a high alcohol content

APPLIANCE FRONT

Hot soapy water:

Clean using a dish cloth and then dry with a soft cloth. Do not use metal or glass scrapers for cleaning.

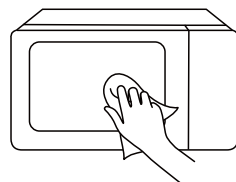

APPLIANCE FRONT WITH STAINLESS STEEL

Hot soapy water:

Clean using a dish cloth and then dry with a soft cloth. Remove splashes and patches of limescale, grease, starch and albumin immediately. Corrosion can form under these patches or splashes. Do not use glass cleaners or metal or glass scrapers for cleaning.

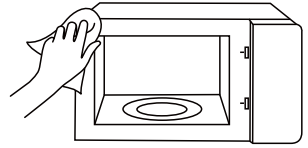

COOKING COMPARTMENT MADE OF STAINLESS STEEL

Hot soapy water or vinegar solution:

Clean using a dish cloth and then dry with a soft cloth. Do not use oven spray or any other aggressive oven cleaners or abrasive materials. Scouring pads, rough sponges and pan cleaners are also unsuitable. These items scratch the surface. Allow the interior surfaces to dry completely.

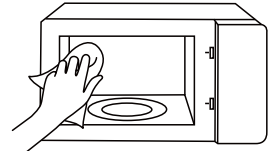

RECESS IN THE COOKING COMPARTMENT

Damp cloth:

Water must not be allowed to run into the appliance through the turntable drive. Dry the turntable drive with a cloth.

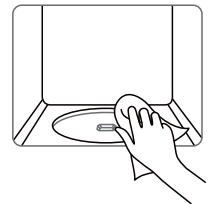

TURNTABLE AND ROLLER RING

Hot soapy water:

When placing the turntable back into its recess, it must engage properly.

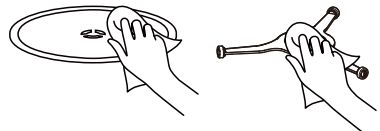

DOOR PANELS

Glass cleaner:

Clean with a dish cloth. Do not use glass scrapers.

TROUBLE SHOOTING

Check your problem by using the chart below and try the solutions for each problem. If the microwave oven still does not work properly, contact the nearest authorized service center.

TROUBLE	POSSIBLE CAUSE	POSSIBLE REMEDY
Oven will not start	<ul style="list-style-type: none"> a. Electrical cord for oven is not plugged in. b. Door is open. c. Wrong operation is set. 	<ul style="list-style-type: none"> a. Plug into the outlet. b. Close the door and try again. c. Check instructions
Arcing or sparking	<ul style="list-style-type: none"> a. Materials to be avoided in microwave oven were used. b. The oven is operated when empty. c. Spilled food remains in the cavity. 	<ul style="list-style-type: none"> a. Use microwave-safe cookware only. b. Do not operate with oven empty. c. Clean cavity with soft damp cloth.
Unevenly cooked foods	<ul style="list-style-type: none"> a. Materials to be avoided in microwave oven were used. b. Food is not defrosted completely. c. Cooking time, power level is not suitable. d. Food is not turned or stirred. 	<ul style="list-style-type: none"> a. Use microwave-safe cookware only. b. Completely defrost food. c. Use correct cooking time, power level. d. Turn or stir food.
Overcooked foods	<ul style="list-style-type: none"> Cooking time, power level is not suitable. 	<ul style="list-style-type: none"> Use correct cooking time, power level.
Undercooked foods	<ul style="list-style-type: none"> a. Materials to be avoided in microwave oven were used. b. Food is not defrosted completely. c. Oven ventilation ports are restricted. d. Cooking time, power level is not suitable. 	<ul style="list-style-type: none"> a. Use microwave-safe cookware only. b. Completely defrost food. c. Check to see that oven ventilation ports are not restricted. d. Use correct cooking time, power level
Improper defrosting	<ul style="list-style-type: none"> a. Materials to be avoided in microwave oven were used. b. Cooking time, power level is not suitable. c. Food is not turned or stirred. 	<ul style="list-style-type: none"> a. Use microwave-safe cookware only. b. Use correct cooking time, power level. c. Turn or stir food.



According to Waste of Electrical and Electronic Equipment (WEEE) directive, WEEE should be separately collected and treated. If at any time in future you need to dispose of this product please do NOT dispose of this product with household waste. Please send this product to WEEE collecting points where available.

#DetailsMatter

MANUALE DI ISTRUZIONI

FORNO A MICROONDE

MW3-AC26SF(WH)

Rivedere il manuale di istruzioni prima dell'utilizzo.

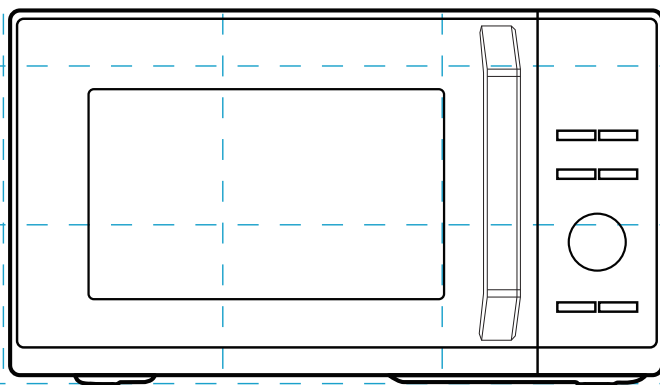

TOSHIBA

CONTENUTI

SICUREZZA DEL PRODOTTO

Precauzioni per evitare possibili sovraesposizioni alle emissioni di microonde	IT-01
Istruzioni importanti sulla sicurezza	IT-03
Installazione della messa a terra	IT-08
Pulizia	IT-10
Utensili	IT-11
Materiali utilizzabili nel forno a microonde	IT-12
Materiali non utilizzabili nel forno a microonde	IT-14

IMPOSTAZIONE DEL PRODOTTO

Configurazione del forno	IT-15
--------------------------------	-------

ISTRUZIONI PER L'USO

Prima di utilizzare per la prima volta	IT-18
Funzionamento.....	IT-19
1. Livelli di potenza	IT-20
2. Impostazione dell'orologio	IT-20
3. Timer da cucina	IT-21
4. Cottura a microonde	IT-22
5. Grill o combinazioni	IT-22
6. Convezione con preriscaldamento	IT-23
7. Convezione senza preriscaldamento	IT-24
8. Menu frittura ad aria	IT-25
9. Menu automatico e menu grill croccante	IT-26
10. Scongelamento in base al peso	IT-28
11. Tempo di scongelamento	IT-28
12. Cottura multifase.....	IT-29

13. Cottura rapida	IT-30
14. Funzione di blocco	IT-31
15. Funzione di richiesta	IT-31

PULIZIA E MANUTENZIONE

Pulizia	IT-32
Risoluzione dei problemi	IT-34



NOTA

PRIMA DI UTILIZZARE IL PRESENTE PRODOTTO,
LEGGERE ACCURATAMENTE LE ISTRUZIONI,
ASSICURARSI DI AVERLE COMPRESSE E SEGUIRLE CON
CURA.
CONSERVARE QUESTO MANUALE PER FUTURE
CONSULTAZIONI.

SICUREZZA DEL PRODOTTO

PRECAUZIONI PER EVITARE POSSIBILI ESPOSIZIONI A UNA ECCESSIVA ENERGIA DEL MICROONDE

- (a). Non tentare di far funzionare il forno con lo sportello aperto, in quanto ciò può comportare un'esposizione dannosa all'energia delle microonde. È di fondamentale importanza evitare di rompere o manomettere gli interblocchi di sicurezza.
- (b). Non posizionare oggetti tra la parte anteriore del forno e la porta ed evitare l'accumulo di residui e polvere sulle superfici delle guarnizioni.
- (c). **AVVERTENZA:** Se lo sportello o le guarnizioni dello sportello presentano danni, non utilizzare il forno fino a quando una persona qualificata non lo abbia riparato.

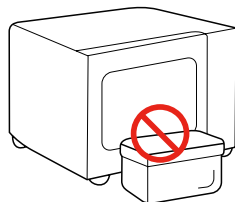

APPENDICE

Se non si garantisce un'adeguata pulizia dell'apparecchio, la sua superficie si potrebbe danneggiare, compromettendone la durata e causando potenziali rischi.

SPECIFICHE

MODELLO	MW3-AC26SF(WH)
TENSIONE/FREQUENZA NOMINALE	230-240 V~ 50 Hz
POTENZA NOMINALE IN INGRESSO (MICROONDE)	1450 W
POTENZA NOMINALE IN USCITA (MICROONDE)	900 W
POTENZA NOMINALE IN INGRESSO (GRILL)	1000 W
POTENZA NOMINALE IN INGRESSO (CONVEZIONE)	2100 W



NOTA

Tutte le immagini contenute nel presente manuale sono solo a scopo illustrativo; potrebbero differire leggermente dall'apparecchiatura acquistata; fare riferimento al prodotto effettivo.

ISTRUZIONI IMPORTANTI SULLA SICUREZZA



AVVERTENZA

Al fine di ridurre il rischio di incendio, scosse elettriche, lesioni alle persone o esposizione a un'eccessiva emissione di energia del forno a microonde, quando si utilizza l'elettrodomestico, osservare le precauzioni di base, tra cui le seguenti:



Leggere e seguire le specifiche: "**PRECAUZIONI PER EVITARE POSSIBILI SOVRAESPOSIZIONI ALLE ECCESSIVE EMISSIONI DI MICROONDE**".



Questo elettrodomestico può essere utilizzato da bambini di età dagli 8 anni in su e da persone con ridotte capacità fisiche, sensoriali o mentali, oppure prive dell'esperienza e delle conoscenze necessarie, se supervisionati o istruiti sull'utilizzo in sicurezza dell'elettrodomestico e se consapevoli dei rischi che ne derivano. Assicurarsi che i bambini non giochino con l'elettrodomestico.



La manutenzione non deve essere eseguita da bambini senza supervisione.



Tenere l'elettrodomestico e il relativo cavo fuori dalla portata dei bambini di età inferiore a 8 anni.





Se il cavo di alimentazione è danneggiato, deve essere sostituito dal produttore, un suo agente di assistenza autorizzato o altro personale qualificato per evitare pericoli.



AVVERTENZA: Assicurarsi che l'elettrodomestico sia spento prima di sostituire la lampada per evitare la possibilità di scosse elettriche.

ISTRUZIONI IMPORTANTI SULLA SICUREZZA

 **AVVERTENZA:** Qualsiasi persona non competente è esposta a pericoli derivanti da interventi di manutenzione o riparazione che implicano la rimozione di una copertura che protegge dall'esposizione alle microonde.

 **AVVERTENZA:** Liquidi e altri alimenti non devono essere riscaldati in contenitori sigillati, in quanto rischiano di esplodere.

 Quando si riscaldano cibi in contenitori di plastica o carta, tenere d'occhio il forno per evitare incendi.



 Utilizzare esclusivamente utensili adatti per l'utilizzo con forni a microonde.

 In caso di emissione di fumo spegnere o scollegare l'elettrodomestico e tenere chiusa la porta per soffocare eventuali fiamme.

 Il riscaldamento a microonde delle bevande può provocare un'ebollizione ritardata, pertanto è necessario prestare attenzione quando si maneggia il contenitore.

 Il contenuto di biberon e vasetti di alimenti per neonati deve essere mescolato o agitato e la temperatura controllata prima del consumo, al fine di evitare ustioni.

ISTRUZIONI IMPORTANTI SULLA SICUREZZA

 Il forno deve essere pulito regolarmente e tutti i depositi di cibo devono essere rimossi. Si prega di mantenere pulita l'area della guida d'onda. Utilizzare un panno umido morbido per pulirlo quando ci sono residui di schizzi di cibo sull'area della guida d'onda o sulla cavità. La mancata pulizia dei residui di cibo può causare scintille innocue o fumo nella cavità del microonde, potrebbe anche verificarsi scolorimento della cavità.

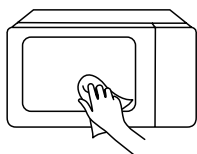

 Il mancato mantenimento del forno in condizioni pulite potrebbe portare a un deterioramento della superficie con conseguente compromissione della vita utile dell'elettrodomestico e a possibili situazioni di pericolo.

 Usare esclusivamente la sonda di temperatura raccomandata per questo forno. (per i forni predisposti all'utilizzo di una sonda per il rilevamento della temperatura.)

 Il forno a microonde deve essere utilizzato con lo sportello decorativo aperto. (per forni dotati di sportello decorativo.)

 Questo elettrodomestico è pensato per uso domestico e per applicazioni simili, come ad esempio:

1. nelle aree cucina dei negozi, degli uffici e altri ambienti di lavoro;
2. dai clienti di hotel, motel e altri edifici residenziali;
3. fattorie;
4. ambienti tipo bed and breakfast.

ISTRUZIONI IMPORTANTI SULLA SICUREZZA

 Il forno a microonde è destinato al riscaldamento di alimenti e bevande. L'asciugatura di alimenti o indumenti e il riscaldamento di cuscini riscaldanti, pantofole, spugne, panni umidi e simili possono comportare il rischio di lesioni, innesco o incendio.

 L'elettrodomestico è destinato ad essere usato in modo indipendente.

 La superficie posteriore degli elettrodomestici deve essere appoggiata a una parete.

 Quando l'elettrodomestico è in funzione, la temperatura delle superfici accessibili può essere molto alta.

 **AVVERTENZA:** Quando l'elettrodomestico funziona in modalità

combinata, i bambini devono utilizzare il forno solo sotto la supervisione di un adulto a causa delle temperature generate.

 Le uova con il guscio e le uova sode intere non devono essere riscaldate nei forni a microonde poiché potrebbero esplodere, anche dopo che il riscaldamento a microonde è terminato.

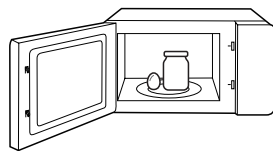



 Non installare l'elettrodomestico dietro sportelli decorativi per evitare il surriscaldamento. (Tale precauzione non è applicabile per elettrodomestici dotati di sportelli decorativi.)

ISTRUZIONI IMPORTANTI SULLA SICUREZZA

 Il forno a microonde non deve essere posizionato in un armadietto a meno che non sia stato testato in un armadietto.

 I contenitori metallici per alimenti e bevande non sono ammessi durante la cottura a microonde.

 L'elettrodomestico non deve essere pulito con un pulitore a vapore.

 L'elettrodomestico non è progettato per funzionare con un timer esterno o con un altro sistema di controllo a distanza separato.

**LEGGERE ATTENTAMENTE E
CONSERVARE PER RIFERIMENTI
FUTURI**

RIDURRE IL RISCHIO DI LESIONI PERSONALI DURANTE L'OPERAZIONE DI MESSA A TERRA

Questo apparecchio deve essere messo a terra. In caso di cortocircuito elettrico, la messa a terra riduce il rischio di scosse elettriche, fornendo un filo di fuga per la corrente elettrica.

Questo apparecchio è dotato di un cavo con un filo di messa a terra con una spina di messa a terra. La spina deve essere collegata a una presa correttamente installata e messa a terra.

AVVERTENZA - L'impostazione impropria della messa a terra può comportare un rischio di scosse elettriche. Consultare un elettricista o un tecnico qualificato in caso di dubbio e incomprensioni delle istruzioni di messa a terra, oppure quando necessita l'assistenza per la messa a terra.

Se è necessario utilizzare una prolunga, utilizzare solo una prolunga a 3 fili.



PERICOLO

Rischio di scosse elettriche

Toccare alcuni dei componenti interni può causare gravi lesioni personali o morte. Non smontare questo apparecchio.

RIDURRE IL RISCHIO DI LESIONI PERSONALI DURANTE L'OPERAZIONE DI MESSA A TERRA



**AVVER-
TENZA**

Rischio di scosse elettriche

L'uso improprio della messa a terra può provocare scosse elettriche. Non collegare alla presa fino a quando l'apparecchio non è installato correttamente e messo a terra.

1. È stato fornito un cavo di alimentazione corto per ridurre i rischi derivanti dall'inciampo su un cavo più lungo.
2. Se si utilizza un cavo lungo o una prolunga:
 - (1). La potenza elettrica nominale contrassegnata del set di cavi o della prolunga deve essere almeno pari alla potenza elettrica dell'apparecchio.
 - (2). La prolunga deve essere un cavo a 3 fili di tipo di messa a terra.
 - (3). Il cavo lungo deve essere disposto in modo che non si drappeggia sul piano di lavoro o sul piano del tavolo, per evitare che i bambini lo tirino o inciampino su di esso.

PULIZIA

Assicurarsi di scollegare l'apparecchio dall'alimentazione.

1. Pulire la cavità del forno dopo l'uso con un panno leggermente umido.
2. Pulire gli accessori nella stessa maniera con acqua saponata.
3. Il telaio e la guarnizione dello sportello e le parti verniciate devono essere puliti accuratamente con un panno umido.
4. Non utilizzare detergenti abrasivi aggressivi o raschietti metallici taglienti per pulire il vetro della porta del forno, poiché possono graffiare la superficie, provocando la rottura del vetro.
5. Suggerimento per la pulizia: Per facilitare la pulizia delle pareti della cavità con cui il cibo cotto può entrare in contatto: Mettere il liquido di mezzo limone in una ciotola, aggiungere 300 ml (1/2 pinta) di acqua e riscaldare al 100% a microonde per 10 minuti. Pulire il forno con un panno morbido e asciutto.

UTENSILI



CAUTELA

Pericolo di lesioni personali:

È pericoloso per chiunque non sia un tecnico competente effettuare qualsiasi operazione di manutenzione o riparazione, che riguarda la rimozione di una copertura contro la perdita dell'energia a microonde. Vedi le istruzioni su "**Materiali ammissibili nel forno a microonde**" o "**Materiali non ammissibili nel forno a microonde**".

Potrebbero esserci alcuni utensili non metallici che non sono sicuri da usare per il microonde. In caso di dubbio, è possibile testare l'utensile in questione seguendo la procedura riportata di seguito.

Test dell'utensile:

1. Riempire un contenitore adatto per essere usato nel microonde con 1 tazza di acqua fredda (250 ml), mettendo all'interno del contenitore insieme l'utensile in questione.
2. Cottura alla massima potenza per 1 min.
3. Controllare attentamente l'utensile. Se l'utensile vuoto è caldo, non usarlo per cucinare a microonde.
4. Non superare il tempo di cottura di 1 minuto.

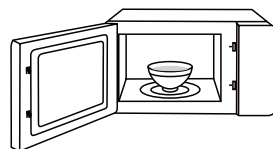





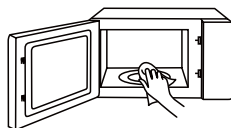











NOTA

MANTENERE PULITA LA CAVITÀ
E L'AREA DELLA GUIDA
DELL'ONDA

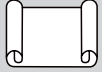

MATERIALI AMMISSIBILI NEL FORNO A MICROONDE

UTENSILI	OSSERVAZIONI	
 Piatto di doratura	Seguire le istruzioni del produttore. Il fondo del piatto di doratura deve essere posizionato almeno 3/16 pollice (5 mm) dal piatto girevole. L'utilizzo scorretto può causare la rottura del piatto girevole.	
 Stoviglie	Solo i tipi adatti per microonde. Seguire le istruzioni del produttore. Non usare piatti con spaccatura o scheggiati.	
 Barattoli di vetro	Rimuovere sempre il coperchio. Utilizzarlo solo per riscaldare il cibo fino a quando non è appena caldo. La maggior parte dei barattoli di vetro non sono resistenti al calore e possono rompersi.	
 Vetreteria	Solo vetreria da forno resistente al calore. Assicurarsi che non ci siano finiture metalliche. Non usare piatti con spaccatura o scheggiati.	
 Sacchetti per la cottura del forno	Seguire le istruzioni del produttore. Non chiudere il sacchetto con una molletta metallica. Lasciare un po' aperto il sacchetto per la fuoriuscita dei vapori.	
 Piatti e bicchieri di carta	Utilizzarli solo per cucinare / riscaldare per breve tempo. Non lasciare il forno incustodito durante la cottura.	
 Asciugamani di carta	Utilizzarlo per coprire il cibo, permettendo di riscaldare e assorbire il grasso. Durante l'utilizzo, controllare sempre il forno e lo si utilizza solo per una cottura a breve termine.	
 Carta pergamena	Utilizzarla come copertura per evitare schizzi o come una guarnizione per la cottura a vapore.	

MATERIALI AMMISSIBILI NEL FORNO A MICROONDE

UTENSILI

OSSERVAZIONI



Plastico

Solo i tipi adatti per microonde. Seguire le istruzioni del produttore. Deve essere etichettato con "Adatto al microonde". Alcuni contenitori di plastica si ammorbidiscono, poiché il cibo all'interno si scalda. I "sacchetti bollenti" e i sacchetti di plastica ben chiusi devono essere lasciati leggermente aperta, forata o ventilata come indicato dalla confezione.



Pellicola trasparente

Solo i tipi adatti per microonde. Utilizzarla per coprire il cibo durante la cottura per trattenere l'umidità. Non lasciare che l'involucro di plastica tocchi il cibo.

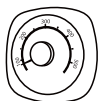

Termometri

Solo per microonde (termometri per carne e caramelle).











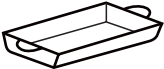



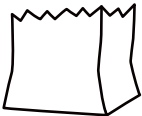

Carta fa forno

Utilizzarlo come copertura per evitare schizzi e trattenere l'umidità.



MATERIALI NON AMMISSIBILI NEL FORNO A MICROONDE

UTENSILI	OSSERVAZIONI
 <p>Vassoio in alluminio</p>	<p>Può causare l'arco. Spostare il cibo in un piatto sicuro per il microonde.</p> 
 <p>Cartone alimentare con manico in metallo</p>	<p>Può causare l'arco. Spostare il cibo in un piatto sicuro per il microonde.</p> 
 <p>Utensili metallici o rifiniti in metallo</p>	<p>Il metallo protegge il cibo dall'energia delle microonde. Il rivestimento metallico può causare l'arco.</p> 
 <p>Fascette a torsione in metallo</p>	<p>Può causare archi e incendio nel forno.</p> 
 <p>Busti di carta</p>	<p>Può causare un incendio nel forno.</p> 
 <p>Schiuma plastica</p>	<p>La schiuma plastica può sciogliere o contaminare il liquido all'interno del contenitore se esposta ad alte temperature.</p> 
 <p>Legno</p>	<p>La legna si asciugherà se utilizzata nel forno a microonde e potrebbe dividersi o rompersi.</p> 

IMPOSTAZIONE DEL PRODOTTO

CONFIGURAZIONE DEL FORNO

(In caso di divergenze tra l'elettrodomestico e le immagini nel presente manuale, farà fede il prodotto effettivo.)

NOMI DELLE PARTI E DEGLI ACCESSORI DEL FORNO A MICROONDE

Rimuovere il forno e tutti i materiali dal cartone e dalla cavità del forno.

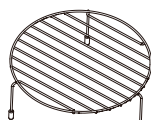

Griglia superiore

Griglia (non può essere utilizzata nella funzione microonde e deve essere posizionata sul vassoio in vetro)

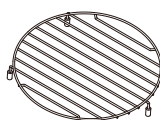

Griglia inferiore

Griglia (non può essere utilizzata nella funzione microonde e deve essere posizionata sul vassoio in vetro)



Teglia da forno (non può essere utilizzata nella funzione microonde e deve essere posizionata sul vassoio in vetro)



Vassoio di vetro

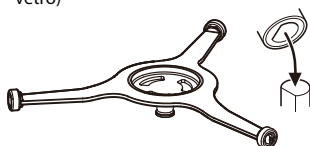

Assemblaggio dell'anello del piatto girevole

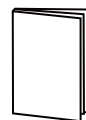

Manuale di istruzioni

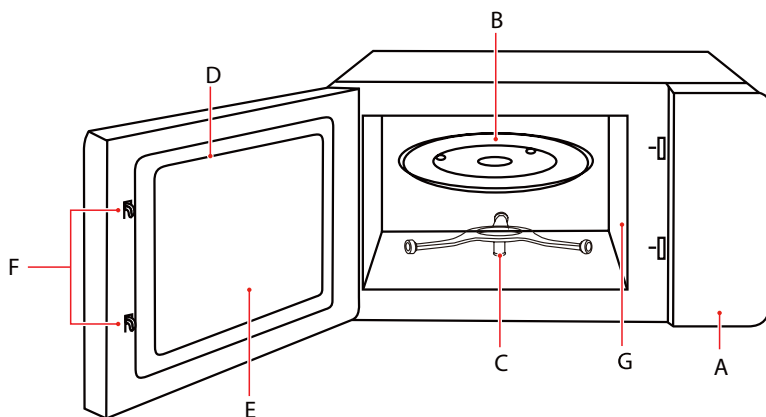

A) Pannello di controllo

B) Vassoio di vetro

C) Assemblaggio dell'anello del piatto girevole

D) Assemblaggio sportello

E) Finestra di osservazione

F) Sistema di interblocco di sicurezza

G) Copertura guida d'onda

CONFIGURAZIONE DEL FORNO

INSTALLAZIONE PIATTO GIREVOLE

Pulire il vano di cottura e posizionare il piatto girevole.

Per i nuovi impianti, verificare che tutti i materiali di imballaggio e gli adesivi della confezione siano stati rimossi dall'albero del piatto girevole.

Prima di usare per la prima volta l'elettrodomestico per la cottura del cibo, posizionare correttamente il piatto girevole. Pulire il vano di cottura e gli accessori. È possibile anche consultare la sezione dedicata alla loro pulizia.

Sistemazione del piatto girevole:

1. Posizionare il complesso del piatto girevole ② nell'incasso del vano di cottura.
2. Posizionare il vassoio di vetro ① sull'assemblaggio dell'anello del piatto girevole ②.

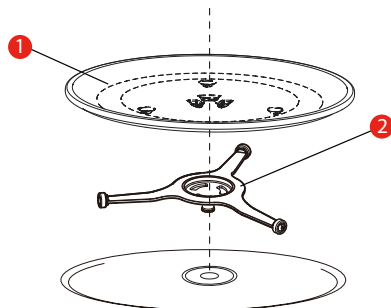

1) Vassoio in vetro

2) Assemblaggio dell'anello del piatto girevole

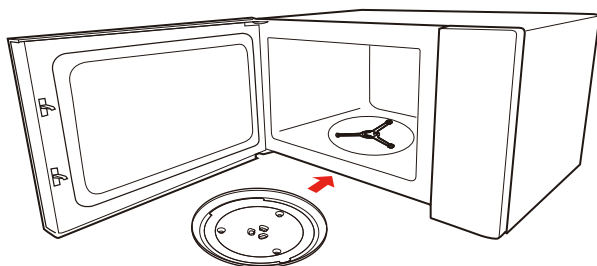

NOTA

- Non usare mai l'elettrodomestico senza piatto girevole. Assicurarsi che sia saldamente agganciato. Il piatto può ruotare in senso orario e antiorario.
- Non capovolgere mai il vassoio di vetro. Il vassoio di vetro non deve mai essere limitato.
- Durante la cottura è necessario utilizzare sempre sia il vassoio di vetro che l'anello del piatto girevole.
- Tutti gli alimenti e i loro contenitori devono essere sempre posizionati sul vassoio di vetro per la cottura.
- Non limitare mai i movimenti del piatto girevole.
- In caso di rottura o incrinatura del vassoio di vetro o dell'anello di tenuta del piatto girevole, contattare il centro di assistenza autorizzato più vicino.

INSTALLAZIONE SUL PIANO DI LAVORO

Rimuovere tutti i materiali di imballaggio e gli accessori. Esaminare il forno per qualsiasi danno come ammaccature o sportello rotto. Evitare l'installazione se il forno è danneggiato.
Mobile: Rimuovere tutte le pellicole protettive presenti sulla superfici interne del forno a microonde. Non rimuovere il coperchio della guida d'onda che è applicato sulla cavità del forno per proteggerne il magnetron.

INSTALLAZIONE

1. Scegliere una superficie piana che fornisca spazio sufficiente per le bocchette di aspirazione e/o di scarico dell'aria.
 - a. L'altezza minima per l'installazione è pari a 85 cm.
 - b. La superficie posteriore dell'elettrodomestico deve essere appoggiata a una parete. Lasciare uno spazio di almeno 30 cm al di sopra del forno. Tra il forno e le pareti adiacenti deve essere lasciato uno spazio minimo di 20 cm.
 - c. Non rimuovere le gambe dalla parte inferiore del forno.
 - d. Il bloccaggio delle aperture di aspirazione e/o scarico dell'aria può provocare danni al forno.
 - e. Posizionare il forno il più lontano possibile da radio e televisori. Il funzionamento del forno a microonde potrebbe causare interferenze al segnale radio o TV.

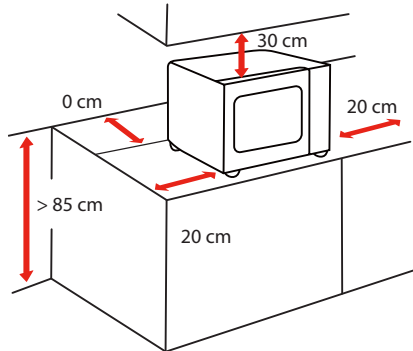

2. Collegare il forno a microonde a una presa elettrica domestica standard. Assicurarsi che la tensione e la frequenza siano uguali alla tensione e alla frequenza sull'etichetta dei dati nominali.



NOTA

- Non installare il forno sopra un piano di cottura o un altro elettrodomestico che genera calore. Se installato in prossimità di una fonte di calore, il forno potrebbe danneggiarsi e la garanzia non sarebbe più valida.

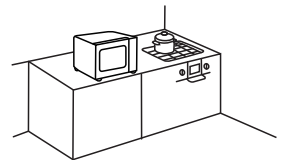

La superficie di accesso potrebbe surriscaldarsi durante il funzionamento

PRIMA DI UTILIZZARE PER LA PRIMA VOLTA

È normale che il forno produca odori sgradevoli al primo utilizzo.

Questa sezione spiega cosa è necessario fare prima di utilizzare il forno a microonde per la prima volta per preparare del cibo. Leggere prima la sezione intitolata "**SICUREZZA DEL PRODOTTO**".

Prima di poter utilizzare il nuovo elettrodomestico, è necessario posizionare correttamente il piatto girevole. È inoltre necessario pulire il vano cottura e gli accessori.



NOTA

- Non usare mai l'elettrodomestico senza piatto girevole.
- Assicurarsi che sia agganciata correttamente. Il piatto girevole può essere ruotato in senso orario o antiorario.

FUNZIONAMENTO

PANNELLO DI CONTROLLO E FUNZIONI

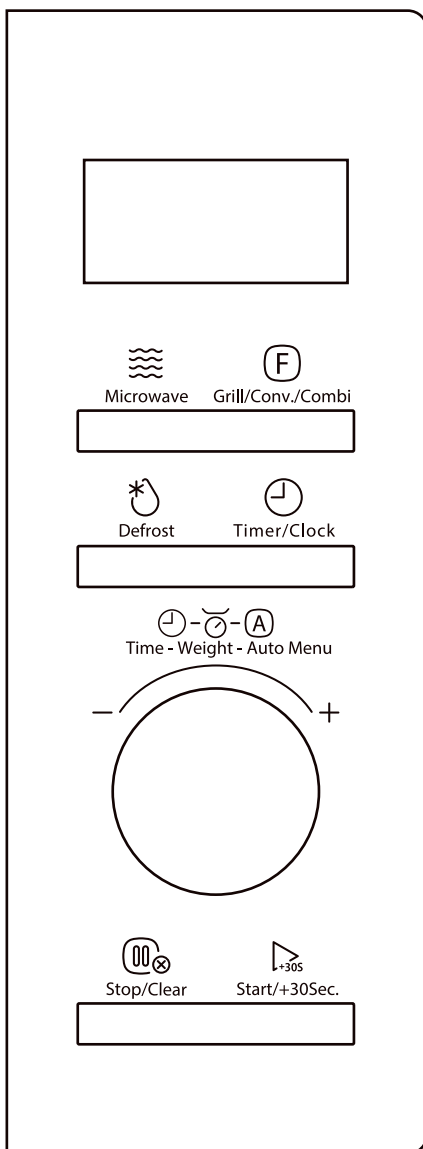



1. LIVELLI DI POTENZA

Sono disponibili cinque livelli di potenza.

LIVELLO	POTENZA	DISPLAY
1	100%	P100
2	80%	P80
3	50%	P50
4	30%	P30
5	10%	P10

2. IMPOSTAZIONE DELL'OROLOGIO

Quando il forno a microonde viene collegato a una presa elettrica, verrà visualizzato "0:00".

- a**  Premere due volte Timer/Clock , viene visualizzato "00:00".
- b** Ruotare la manopola per impostare le cifre delle ore, entro l'intervallo 0-23.
- c**   Premere Start/+30Sec. o Timer/Clock per confermare le cifre dell'ora.
- d** Ruotare la manopola per impostare le cifre dei minuti, entro l'intervallo 0-59.

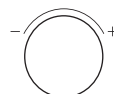
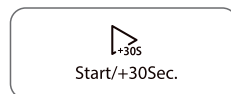
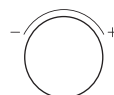

e Premere  Start/+30Sec. o  Timer/Clock per confermare.



- Quando il forno è acceso, se l'orologio non è impostato, non funziona.
- Durante l'impostazione dell'orologio, se non viene eseguita alcuna operazione entro 5 minuti o se viene premuto direttamente  , la visualizzazione tornerà automaticamente all'impostazione dell'orologio precedente.

3. TIMER DA CUCINA

Quando il forno a microonde viene collegato a una presa elettrica, verrà visualizzato "0:00".

a Premere una volta  Timer/Clock



b Ruotare la manopola per scegliere il tempo entro l'intervallo 0:05-95:00.

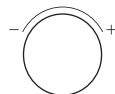









c Premere  Start/+30Sec. per avviare il conto alla rovescia.







- L'impostazione del timer da cucina è diversa da quella dell'orologio; si tratta semplicemente di un timer.
- Durante il funzionamento del timer da cucina, non può essere impostata alcuna funzione di cottura.

4. COTTURA A MICROONDE

Quando il forno a microonde viene collegato a una presa elettrica, verrà visualizzato "0:00".

- a** o
- Premere " Microwave " più volte per scegliere il livello di potenza.
- 
- Premere una volta " Microwave " e ruotare la manopola per impostare il livello di potenza
- 
- 
- b**
- Premere  Start/+30Sec. per confermare il livello di potenza.
- 
- c**
- Ruotare la manopola per impostare l'ora, il valore di tempo massimo è "95:00".
- 
- d**
- Premere  Start/+30Sec. per avviare la cottura.
- 

5. GRILL O COMBINAZIONI

- a** o
- Premere più volte  Grill/Conv./Combi per scegliere la modalità.
- 
- Premere una volta  Grill/Conv./Combi , quindi ruotare la manopola per scegliere la modalità.
- 
- 
- "G-1, C-1...C-4, 150 ° C, 160 ° C...240 ° C" verranno visualizzati in ordine. ("G-1" è la funzione grill, mentre "C-1~C-4" sono le combinazioni).

b Premere  Start/+30Sec. per confermare la modalità.



c Ruotare la manopola per impostare l'ora, il valore di tempo massimo è "95:00".

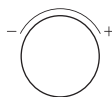

d Premere  Start/+30Sec. per avviare la cottura.



NOTA

• Trascorsa la metà del tempo, il cicalino suona per ricordare di girare gli alimenti durante la funzione grill. Se non si eseguono operazioni, il forno continua a funzionare.

6. CONVEZIONE CON PRERISCALDAMENTO

a Premere più volte  Grill/Conv./Combi per scegliere la temperatura di convezione.



a Premere una volta  Grill/Conv./Combi, quindi ruotare la manopola per scegliere la temperatura di convezione.



150°C, 160°C.....240°C sono disponibili.

b Premere due volte  Start/+30Sec. per avviare il preriscaldamento. Al termine del preriscaldamento, la temperatura lampeggia, quindi aprire lo sportello e posizionare gli alimenti nel forno.



- c** Ruotare la manopola per impostare l'ora, il valore di tempo massimo è "95:00".

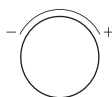

- d** Premere  Start/+30Sec. per avviare la cottura.



7. CONVEZIONE SENZA PRERISCALDAMENTO

- a** Premere più volte  Grill/Conv./Combi per scegliere la temperatura di convezione.



- a** Premere una volta  Grill/Conv./Combi, quindi ruotare la manopola per scegliere la temperatura di convezione. 150°C, 160°C.....240°C sono disponibili.



- b** Premere  Start/+30Sec. per confermare la temperatura.



- c** Ruotare la manopola per impostare l'ora, il valore di tempo massimo è "95:00".

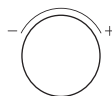



- d** Premere  Start/+30Sec. per avviare la cottura.

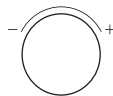

8. MENU FRITTURA AD ARIA

- a** In stato di attesa, ruotare la manopola verso destra per accedere alla funzione menu.
Ruotare ripetutamente la manopola per scegliere il tipo di menu H-1.



- b** Premere  Start/+30Sec. per confermare il tipo di menu.



- c** Ruotare la manopola per selezionare il sotto-menu.

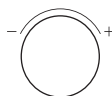

- d** Premere  Start/+30Sec. per avviare la cottura.



TABELLA DEL MENU FRITTURA AD ARIA

DISPLAY	MENU	PESO
H-1	Patatine fritte surgelate	300 g
H-2	Crocchette di patate surgelate	350 g
H-3	Calamaro surgelato	250 g
H-4	Anelli di cipolla surgelati	250 g
H-5	Bocconcini di pollo surgelati	350 g
H-6	Scaloppine	400 g
H-7	Gamberi	250 g
H-8	Verdura	200 g
H-9	Involtini primavera	300 g

Nota: Il peso del menu di frittura ad aria non può essere impostato.

9. MENU AUTOMATICO E MENU GRILL CROCCANTE

- a** In stato di attesa, ruotare la manopola verso destra per accedere alla funzione menu. Ruotare ripetutamente la manopola per scegliere il menu automatico (display A-1) o il menu grill croccante (display C-1). Ad esempio, scegliere il C-1.

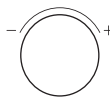

- b** Premere  Start/+30Sec. per confermare.



- c** Ruotare la manopola per scegliere il sotto-menu, sono disponibili C-1~C-4.

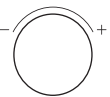

- d** Premere  Start/+30Sec. per confermare. Ruotare la manopola per selezionare il peso. Il peso di C-3 e C-4 non può essere impostato.



- e** Premere  Start/+30Sec. per confermare.



TABELLA MENU GRILL CROCCANTE

DISPLAY	MENU	PESO
C-1	Cordon bleu	300 g
		600 g
		900 g
C-2	lasagne	200 g
		300 g
		400 g
		500 g
C-3	pane	100 g
C-4	torta/crostata	8 (circa 350g)

TABELLA DEL MENU AUTOMATICO

MENU	DISPLAY	PESO/ QUANTITÀ	LIVELLO DI POTENZA
A-1 RISCALDAMENTO AUTOMATICO	150 g	150 g	P100
	250 g	250 g	
	350 g	350 g	
	450 g	450 g	
	600 g	600 g	
A-2 PATATE	1	1 (circa 230 g)	P100
	2	2	
	3	3	
A-3 CARNE	150 g	150 g	P80
	300 g	300 g	
	450 g	450 g	
	600 g	600 g	
A-4 VERDURA	150 g	150 g	P100
	350 g	350 g	
	500 g	500 g	
A-5 PESCE	150 g	150 g	P80
	250 g	250 g	
	350 g	350 g	
	450 g	450 g	
	650 g	650 g	
A-6 PASTA	50 g (con acqua fredda 450 g)	50 g	P80
	100 g (con acqua fredda 800 g)	100 g	
	150 g (con acqua fredda 1200 g)	150 g	
A-7 ZUPPA	200 g	200 g	P100
	400 g	400 g	
	600 g	600 g	
A-8 TORTE	475 g	475 g	CONVEZ.160°C (Con preriscaldamento 160°C)
A-9 PIZZA	100 g	100 g	C-4
	200 g	200 g	
	300 g	300 g	
A10 POLLO	500 g	500 g	C-4
	750 g	750 g	
	1000 g	1000 g	
	1200 g	1200 g	

10. SBRINAMENTO IN BASE AL PESO

- a** Premere una volta "  Defrost " e "dEF1" verrà visualizzato.



- b** Ruotare la manopola per impostare il peso degli alimenti entro l'intervallo "100 g-2000 g".

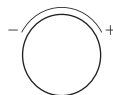

- c** Premere  Start/+30Sec. per avviare lo scongelamento.



NOTA

- Il cicalino suonerà due volte per ricordare di girare gli alimenti durante lo scongelamento.

11. TEMPO DI SCONGELAMENTO

- a** Premere due volte "  Defrost ", verrà visualizzato "dEF2".

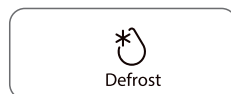

- b** Ruotare la manopola per impostare l'ora. Il massimo valore di tempo è "95:00".

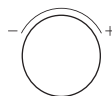

- c** Premere  Start/+30Sec. per avviare lo scongelamento.

Start/+30Sec.



NOTA

- Il cicalino suonerà per ricordare di girare gli alimenti una volta trascorsa la metà del tempo.
- Il livello di potenza predefinito è P30 e non può essere modificato.

12. COTTURA MULTIFASE

- a** Premere due volte  "Defrost", verrà visualizzato "dEF2".

Defrost

- b** Ruotare la manopola per impostare l'ora, il valore di tempo massimo è "95:00".



- c** Premere  Grill/Conv./Combi per scegliere la modalità di cottura.

Grill/Conv./Combi

- d** Premere  Start/+30Sec. per confermare.

Start/+30Sec.

- e** Ruotare la manopola per impostare l'ora, il valore di tempo massimo è "95:00".

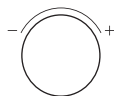

- f** Premere  Start/+30Sec. per avviare la cottura.



NOTA

- Nella cottura multifase è possibile impostare due fasi di cottura.
- Se si imposta la funzione di scongelamento, quest'ultima funzionerà automaticamente nella prima fase.
- Timer da cucina, Menu automatico, Cottura rapida e Preriscaldamento non possono essere impostati come una delle funzioni di cottura multifase.

13. COTTURA RAPIDA

- a** Ruotare una volta la manopola a sinistra per scegliere la modalità di cottura con un livello di potenza al 100% per 5 secondi.

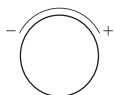

- b** Ruotare la manopola per impostare l'ora. Il massimo valore di tempo è "95:00".

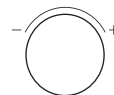

- c** Premere  Start/+30Sec. per avviare la cottura.



- a** Premere una volta  Start/+30Sec. per effettuare direttamente la cottura con un livello di potenza al 100% e per 30 secondi.



14. FUNZIONE DI BLOCCO

- a** Per bloccare il microonde in modo che non possa essere azionato da bambini o da altri utenti indesiderati, premere il tasto  per 3 secondi e l'icona del lucchetto verrà visualizzata sul display.



- b** Per sbloccare, premere il tasto “  ” per 3 secondi.



15. FUNZIONE DI RICHIESTA

- a** Quando il forno è in fase di cottura, premere “  ” per visualizzare il tempo corrente sul display per tre secondi.



PULIZIA

Con cura e pulizia adeguata, il tuo apparecchio manterrà il suo aspetto estetico e rimarrà perfettamente funzionante per lungo periodo di tempo. Spiegheremo qui come curare e pulire correttamente il tuo apparecchio.



AVVERTENZA

- Il graffio del vetro dello sportello dell'apparecchio può trasformarsi in una crepa. Non utilizzare raschietti per vetro, strumenti taglienti o abrasivi per la pulizia o detersivi.
- La superficie dell'apparecchio può danneggiarsi se non viene pulita adeguatamente. L'energia del microonde potrebbe fuoriuscire. Pulire regolarmente l'apparecchio e rimuovere immediatamente eventuali residui di cibo.
- Non immergere l'apparecchio in acqua né pulirlo sotto il flusso d'acqua.

Detergente di pulizia

Per garantire che le varie superfici dell'apparecchio non vengano danneggiate dall'utilizzo di un detergente sbagliato, rispettare le indicazioni seguenti. Lavare accuratamente i panni e spugne nuovi prima dell'uso.

Non utilizzare:



Detergenti aggressivi o abrasivi



Raschietti per metallo o vetro per la pulizia dei pannelli dello sportello



Raschietti per metallo o vetro per la pulizia della guarnizione dello sportello



Detergenti ad alto contenuto di alcol



Detergenti ad alto contenuto di alcol

PARTE ANTERIORE DELL'APPARECCHIO

Acqua saponata calda:

Pulire con un panno lavapiatti e quindi asciugare con un panno morbido.

Non utilizzare raschietti per metallo o vetro per la pulizia.

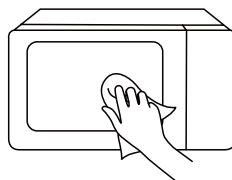

PULIZIA

PIASTRA FRONTALE DELL'APPARECCHIO

Acqua calda saponata:

Pulire con un canovaccio e poi asciugare con un panno morbido. Rimuovere immediatamente schizzi e macchie di calcare, grasso, amido e albumina. Queste macchie o schizzi possono dare origine alla corrosione del materiale. Non utilizzare detergenti per vetri o raschietti per metallo o vetro per la pulizia.

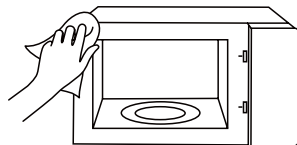

CAVITÀ DELL'APPARECCHIO

Acqua calda saponata o soluzione di aceto:

Pulire con un canovaccio e poi asciugare con un panno morbido. Non utilizzare spray detergente per forni o altri detergenti per forni che sono aggressivi o che sono fatti con materiali abrasivi. Inoltre, nemmeno le pagliette abrasive, spugne ruvide e detergenti per pentole sono adatte. Poiché questi prodotti possono graffiare la superficie. Lasciare asciugare completamente le superfici interne.

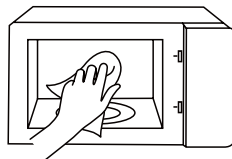

NICCHIA NEL VANO COTTURA

Panno bagnato:

L'acqua non può entrare nell'apparecchio attraverso la piastra girevole. Asciugare la piastra girevole con un panno.

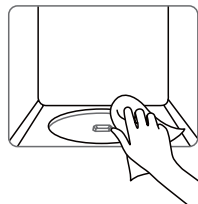

PIASTRA GIREVOLE E ANELLO ROTONDO

Acqua calda saponata:

Quando si ripone la piastra girevole nella sua nicchia, la piastra girevole deve essere inserita correttamente.

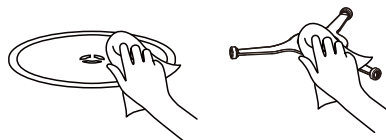

PANNELLO DELLO SPORTELLO

Detergente del vetro:

Pulire con un canovaccio. Non utilizzare raschietti per vetro.

RISOLUZIONE DEI PROBLEMI

Provare le soluzioni per ogni problema dopo aver utilizzato la tabella sottostante per verificare il problema. Se il forno a microonde continua a non funzionare correttamente, rivolgersi al servizio di assistenza autorizzato più vicino.

TROPPO	PROBABILE CAUSA	POSSIBILE SOLUZIONE
Il forno non si avvia	<ul style="list-style-type: none"> a. Il cavo elettrico del forno non è inserito. b. Lo sportello è aperto. c. È stato selezionato il funzionamento non corretto. 	<ul style="list-style-type: none"> a. Collegare alla presa di corrente. b. Chiudere lo sportello e riprovare. c. Verificare le indicazioni.
Arco elettrico o scintilla	<ul style="list-style-type: none"> a. Sono stati utilizzati articoli che non dovrebbero essere utilizzati in un forno a microonde. b. Il forno viene utilizzato quando è vuoto. c. Il cibo che si è rovesciato rimane nella cavità. 	<ul style="list-style-type: none"> a. Utilizzare solo pentole adatte al microonde. b. Non utilizzare mai un forno vuoto. c. Pulire la cavità con un panno umido.
Cibi cotti in modo non uniforme	<ul style="list-style-type: none"> a. Sono stati utilizzati articoli che non dovrebbero essere utilizzati in un forno a microonde. b. Il cibo non si è completamente scongelato. c. Il livello di potenza è insufficiente per il tempo di cottura. d. La pietanza non è stata girata o mescolata. 	<ul style="list-style-type: none"> a. Usare solo pentole adatte al microonde. b. Scongelare completamente gli alimenti. c. Utilizzare la potenza e il tempo di cottura adeguati. d. Mescolare o girare gli alimenti.
Cibi troppo cotti	Il tempo di cottura e il livello di potenza sono insufficienti.	Utilizzare la potenza e il tempo di cottura adeguati.
Alimenti poco cotti	<ul style="list-style-type: none"> a. Sono stati utilizzati articoli che non dovrebbero essere utilizzati in un forno a microonde. b. Il cibo non si è completamente scongelato. c. Le porte di ventilazione del forno sono limitate. d. Il tempo di cottura e il livello di potenza sono inadeguati. 	<ul style="list-style-type: none"> a. Utilizzare solo pentole adatte al microonde. b. Scongelare completamente gli alimenti. c. Verificare che le aperture di ventilazione del forno non siano ostruite. d. Utilizzare il tempo di cottura e il livello di potenza adeguati.
Scongelamento non corretto	<ul style="list-style-type: none"> a. Sono stati utilizzati articoli che non dovrebbero essere utilizzati in un forno a microonde. b. Livello di potenza e tempo di cottura inadeguati. c. Non sono stati girati o strofinati gli alimenti. 	<ul style="list-style-type: none"> a. Utilizzare solo pentole adatte al microonde. b. utilizzare il tempo di cottura e il livello di potenza consigliati. c. Scartare o girare il cibo.



Secondo la direttiva sui rifiuti di apparecchiature elettriche ed elettroniche (RAEE), i RAEE devono essere raccolti e smaltiti separatamente. Se in futuro si dovesse smaltire questo prodotto, si prega di non smaltirlo insieme ai rifiuti domestici. Portare il prodotto in un punto di raccolta RAEE, se disponibile.

#DetailsMatter

MANUAL DE INSTRUCCIONES

HORNO MICROONDAS

MW3-AC26SF(WH)

Lea este manual de instrucciones antes de utilizar el aparato.

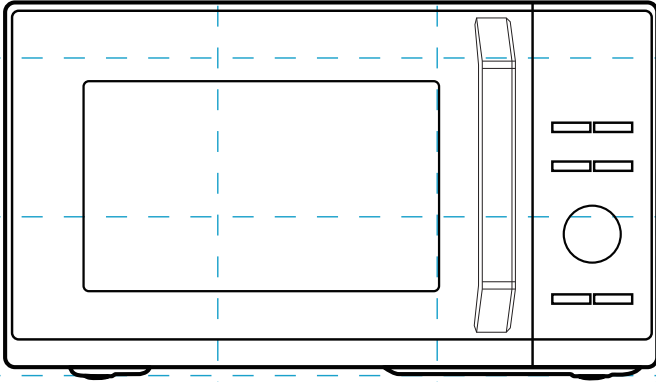

ÍNDICE

SEGURIDAD DEL PRODUCTO

Precauciones para evitar una posible exposición a una energía excesiva del microondas ...	ES-01
Instrucciones importantes de seguridad.....	ES-03
Instalación a tierra	ES-08
Limpieza	ES-10
Utensilios.....	ES-11
Materiales que puede usar en un horno microondas.....	ES-12
Materiales que no pueden usarse en un horno microondas	ES-14

CONFIGURACIÓN DEL PRODUCTO

Preparación del horno.....	ES-15
----------------------------	-------

INSTRUCCIONES DE USO

Antes de usarlo por primera vez	ES-18
Funcionamiento	ES-19
1. Niveles de potencia.....	ES-20
2. Configuración del reloj.....	ES-20
3. Temporizador de la cocina.....	ES-21
4. Cocinado con el microondas.....	ES-22
5. PARRILLA O COMBINACIÓN.....	ES-22
6. Convección con precalentamiento.....	ES-23
7. Convección sin precalentamiento.....	ES-24
8. Menú Airfry	ES-25
9. Menú automático y menú de parrilla crujiente	ES-26
10. Descongelación por peso	ES-28
11. Tiempo de descongelación	ES-28
12. Cocción multifase.....	ES-29

13. Cocina rápida.....	ES-30
14. Función de bloqueo.....	ES-31
15. Función de pregunta.....	ES-31

LIMPIEZA Y MANTENIMIENTO

Limpieza.....	ES-32
Solución de problemas.....	EN-34



NOTA

ANTES DE PONER EN FUNCIONAMIENTO ESTE PRODUCTO, LEA, ENTIENDA Y SIGA ESTAS INSTRUCCIONES. ASEGÚRESE DE GUARDAR ESTE LIBRETO COMO REFERENCIA FUTURA.

SEGURIDAD DEL PRODUCTO

PRECAUCIONES PARA EVITAR UNA POSIBLE EXPOSICIÓN A UN EXCESO DE ENERGÍA DE MICROONDAS

- (a). No intente operar este horno con la puerta abierta, ya que esto puede provocar una exposición nociva a la energía del microondas. Es importante no romper o interferir en los cierres de seguridad.
- (b). No coloque ningún objeto entre la cara frontal del horno y la puerta ni permita que se acumulen suciedad o restos de limpiador en las superficies de sellado.
- (c). **ADVERTENCIA:** Si la puerta o las juntas de la puerta están dañadas, el horno no debe ponerse en funcionamiento hasta que haya sido reparado por parte de una persona competente.

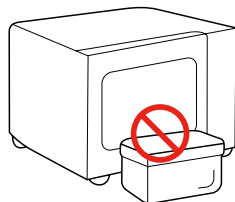

APÉNDICE

Si el aparato no se mantiene en un buen estado de limpieza, su superficie puede degradarse y afectar la vida útil del aparato y provocar una situación peligrosa.

ESPECIFICACIONES

MODELO	MW3-AC26SF(WH)
TENSIÓN NOMINAL/FRECUENCIA	230-240 V~ 50 Hz
POTENCIA DE ENTRADA NOMINAL (DEL MICROONDAS)	1450 W
POTENCIA DE SALIDA NOMINAL (MICROONDAS)	900 W
POTENCIA DE ENTRADA NOMINAL (PARRILLA):	1000 W
POTENCIA DE ENTRADA NOMINAL (CONVECCIÓN):	2100 W



NOTA

Todas las imágenes de este manual tiene únicamente una finalidad ilustrativa; estas pueden ser ligeramente diferentes del equipo adquirido; remítase al producto real.

INSTRUCCIONES IMPORTANTES DE SEGURIDAD



ADVERTENCIA

Para reducir el riesgo de incendio, descarga eléctrica, lesiones personales o exposición a un exceso de energía del horno microondas cuando use el aparato, siga las precauciones básicas, incluyendo las siguientes:



Lea y siga estos puntos específicos:
«**PRECAUCIONES PARA EVITAR UNA POSIBLE EXPOSICIÓN A UN EXCESO DE ENERGÍA DEL MICROONDAS**».



Este aparato puede usarse por niños con edades de 8 años o más y personas con capacidades físicas, mentales o sensoriales reducidas o falta de conocimientos o experiencia si se les ha ofrecido supervisión o instrucción respecto al uso del aparato de forma segura y entienden los riesgos que implica. Los niños no deben jugar con el aparato.



La limpieza y el mantenimiento no deben ser realizados por niños sin supervisión.



Mantenga el aparato y su cable alejado del alcance de los niños menores de 8 años.





Si el cable de alimentación está dañado, debe ser sustituido por el fabricante, su agente de servicio o una persona con cualificación similar con el fin de evitar riesgos.



ADVERTENCIA: Asegúrese de que el aparato está apagado antes de sustituir la bombilla para evitar la posibilidad de una descarga eléctrica.

INSTRUCCIONES IMPORTANTES DE SEGURIDAD

 **ADVERTENCIA:** Es peligroso que cualquier persona que no sea una persona competente lleve a cabo cualquier operación de servicio o reparación que implique la retirada de la carcasa que proteja contra la exposición a la energía de microondas.

 **ADVERTENCIA:** No se debe calentar líquidos u otros alimentos en recipientes cerrados, ya que pueden explotar.

 Cuando se calienten alimentos en recipientes de plástico o papel, vigile el horno debido a la posibilidad de ignición.

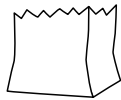

 Use únicamente utensilios que sean aptos para su uso en hornos microondas.

 Si sale humo, apague o desenchufe el aparato y mantenga la puerta cerrada para sofocar las llamas.

 El calentamiento de bebidas en el microondas puede provocar una ebullición eruptiva retardada, por lo que se debe tener cuidado al manipular el recipiente.

 Los contenidos de biberones y los potitos deben agitarse o removerse y se debe comprobar la temperatura antes de su consumo para evitar quemaduras.

INSTRUCCIONES IMPORTANTES DE SEGURIDAD

 El horno debe limpiarse con regularidad y deben eliminarse los depósitos de alimentos.

Mantenga limpia la zona de la guía de ondas. Utilice un paño suave y húmedo para limpiarlo cuando haya restos de salpicaduras de alimentos en la zona de la guía de ondas o en la cavidad. Si no se limpian los restos de comida pueden producirse chispas inocuas o algo de humo en la cavidad del microondas, también puede producirse decoloración de la cavidad.

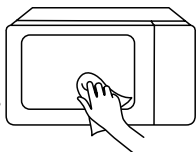

 En caso de no mantener el horno en condiciones de limpieza, podría producirse un deterioro de la superficie que podría afectar de forma negativa a la vida útil del aparato y, probablemente, dar lugar a una situación peligrosa.

 Use únicamente la sonda de temperatura recomendada para este horno. (para hornos provistos de la posibilidad de usar una sonda de temperatura.)

 El horno microondas debe ponerse en funcionamiento con la puerta decorativa abierta. (para hornos con una puerta decorativa).

 Este aparato ha sido diseñado para uso doméstico y aplicaciones similares, como:

1. Zonas de cocina para el personal en tiendas, oficinas y otros entornos laborales;
2. Por parte de clientes en hoteles, moteles y otros entornos de tipo residencial;
3. Casas rurales;
4. Entornos de tipo hostel.

INSTRUCCIONES IMPORTANTES DE SEGURIDAD

 El horno microondas está diseñado para el calentamiento de alimentos y bebidas. El secado de alimentos o ropa y el calentamiento de mantas eléctricas, zapatillas, esponjas, paños húmedos y similares puede provocar riesgo de lesiones, ignición o incendio.

 El aparato está diseñado para usarse de forma independiente.

 La superficie posterior del aparato debe colocarse contra una pared.

 La temperatura de las superficies accesibles puede ser alta cuando el aparato esté en funcionamiento.

 **ADVERTENCIA:** Cuando el aparato está funcionando en el modo combinado, los

niños solo deben usarlo bajo la supervisión de un adulto debido a las temperaturas generadas.

 Los huevos con cáscara y los huevos duros enteros no deben calentarse en hornos microondas, ya que pueden explotar, incluso después de haber finalizado el calentamiento por microondas.

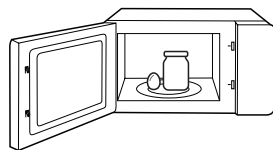



 El aparato no debe instalarse detrás de una puerta decorativa para evitar el sobrecalentamiento. (Esto no es aplicable a aparatos con una puerta decorativa).

INSTRUCCIONES IMPORTANTES DE SEGURIDAD

 El horno microondas no debe colocarse en un armario a menos que se haya probado dentro del mismo.

 No se permiten recipientes metálicos para alimentos y bebidas durante la cocción con el microondas.

 El aparato no debe limpiarse con un limpiador a vapor.

 Los aparatos no están diseñados para funcionar por medio de un temporizador externo o un sistema de control remoto independiente.

LÉALO DETENIDAMENTE Y
GUÁRDELO COMO REFERENCIA
FUTURA

PARA REDUCIR EL RIESGO DE LESIONES A LAS PERSONAS PARA INSTALACIÓN DE PUESTA A TIERRA

Este aparato debe estar conectado a tierra. En caso de un cortocircuito eléctrico, la conexión a tierra reduce el riesgo de descarga eléctrica al proporcionar un cable de escape para la corriente eléctrica.

Este aparato está provisto de un cable que tiene un cable de conexión a tierra con un enchufe a tierra. El enchufe debe estar conectado a un tomacorriente que esté correctamente instalado y conectado a tierra.

ADVERTENCIA - El uso inadecuado de la conexión a tierra puede resultar en un riesgo de descarga eléctrica. Consulte a un electricista o técnico calificado cuando no entiende completamente las instrucciones de conexión a tierra o cuando existen dudas sobre si el aparato está conectado a tierra correctamente.

Use solo un cable de extensión de 3 hilos si es necesario.



PELIGRO

Peligro de Descarga Eléctrica:

Tocar algunos de los componentes internos puede causar lesiones personales graves o la muerte. No desmonte el aparato.

PARA REDUCIR EL RIESGO DE LESIONES A LAS PERSONAS PARA INSTALACIÓN DE PUESTA A TIERRA



ADVERTENCIA

Peligro de Descarga Eléctrica:

El uso inadecuado de la conexión a tierra puede provocar una descarga eléctrica. No lo enchufe en un tomacorriente hasta que el aparato esté correctamente instalado y conectado a tierra.

1. Se proporciona un cable corto de fuente de alimentación para reducir los riesgos de enredarse o tropezarse con un cable más largo.
2. Si se usa un cable largo o un cable de extensión:
 - (1).La clasificación eléctrica marcada del juego de cables o del cable de extensión debe ser al menos tan buena como la clasificación eléctrica del aparato.
 - (2).El cable de extensión debe ser un cable de 3 hilos a tierra.
 - (3).El cable más largo debe colocarse de manera que no caiga sobre la encimera o la mesa, donde los niños puedan tirar de él o tropezar.

LIMPIEZA

Asegúrese de desenchufar el aparato de la fuente de alimentación.

1. Limpie la cavidad del horno con un paño poco húmedo después del uso.
2. Limpie los accesorios con agua y jabón de la forma habitual.
3. Deben limpiar el marco de la puerta y las juntas y las partes cercanas cuidadosamente con un paño húmedo cuando estén sucios.
4. No utilice limpiadores abrasivos fuertes o raspadores metálicos afilados para limpiar el vidrio de la puerta del horno, ya que pueden dañar la superficie, lo que puede provocar la rotura del vidrio.
5. Consejo de limpieza --- Para limpiar fácilmente las paredes de la cavidad que los alimentos cocinados pueden tocar: Coloque medio limón en un tazón, agregue 300 ml (1/2 pinta) de agua y caliente al 100% el microondas durante 10 minutos. Limpie el horno con un paño suave y seco.

UTENSILLOS



PRECAUCIÓN

Riesgo de Lesiones Personales:

Es peligroso para cualquier persona no competente realizar cualquier servicio u operación de reparación relacionada con la retirada de una cubierta que brinda protección contra la exposición a la energía de microondas.

Consulte las instrucciones en **"Materiales que se pueden usar en el horno de microondas"** o **"Materiales que no se pueden usar en el horno de microondas"**.

Puede haber ciertos utensilios no metálicos que no sean seguros para usar en el microondas.

En caso de duda, puede probar el utensilio en cuestión siguiendo el procedimiento a continuación.

Prueba de Utensilios:

1. Llene un recipiente apto para microondas con 1 taza de agua fría (250 ml) junto con el utensilio en cuestión.
2. Cocine a máxima potencia durante 1 minuto.
3. Sienta con cuidado el utensilio. Si el utensilio vacío está caliente, no lo use para cocinar en el microondas.
4. No exceda el tiempo de cocción de 1 minuto.

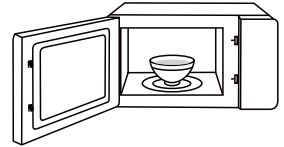





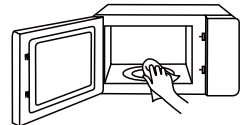







NOTA









MANTENGA LIMPIO EL ÁREA DE LAGUÍA DE CAVIDAD Y ONDAS

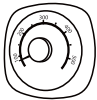

MATERIALES QUE SE PUEDEN USAR EN EL HORNO DE MICROONDAS

UTENSILLOS	OBSERVACIONES	
 Plato para dorar	Siga las instrucciones del fabricante. El fondo del plato para dorar debe estar al menos 3/16 pulgadas (5 mm) por encima del plato giratorio. El uso incorrecto puede hacer que se rompa el plato giratorio.	
 Vajilla	Solo apto para microondas. Siga las instrucciones del fabricante. No utilice platos rotos o astillados.	
 Jarras de vidrio	Retire siempre la tapa. Úselo solo para calentar alimentos hasta que estén calientes. La mayoría de los frascos de vidrio no son resistentes al calor y pueden romperse.	
 Cristalería	Solo cristalería para horno resistente al calor. Asegúrese de que no haya molduras metálicas. No utilice platos rotos o astillados.	
 Bolsas para cocinar al horno	Siga las instrucciones del fabricante. No cierre con amarre de metal. Haga ranuras para permitir que salga el vapor.	
 Platos y vasos de papel	Uso solo para cocinar/calentar a corto plazo. No deje el horno desatendido mientras cocina.	
 Toallas de papel	Úselo para cubrir alimentos para recalentar y absorber grasa. Úselo con supervisión solo para una cocción a corto plazo.	
 Papel pergamino	Úselo como cubierta para evitar salpicaduras o como envoltorio para cocinar al vapor.	

MATERIALES QUE SE PUEDEN USAR EN EL HORNO DE MICROONDAS

UTENSILLOS	OBSERVACIONES
 <p data-bbox="153 499 232 523">Plástico</p>	<p data-bbox="336 371 901 571">Solo apto para microondas. Siga las instrucciones del fabricante. Debe estar etiquetado como "Microwave Safe (Apto para Microondas)". Algunos recipientes de plástico se ablandan a medida que la comida del interior se calienta. Las "bolsas para hervir" y las bolsas de plástico bien cerradas deben cortarse, perforarse o ventilarse según las instrucciones del paquete.</p> 
 <p data-bbox="88 707 298 730">Envoltura de plástico</p>	<p data-bbox="336 611 882 722">Solo apto para microondas. Úselo para cubrir los alimentos durante la cocción para retener la humedad. No permita que la envoltura de plástico toque los alimentos.</p> 
 <p data-bbox="123 866 263 890">Termómetros</p>	<p data-bbox="336 802 874 850">Solo apto para microondas (termómetros para carne y dulces)</p> 
 <p data-bbox="115 1018 270 1042">Papel encerado</p>	<p data-bbox="336 954 901 1002">Úselo como cubierta para evitar salpicaduras y retener la humedad.</p> 

MATERIALES QUE NO SE PUEDEN USAR EN EL HORNO DE MICROONDAS

UTENSILLOS	OBSERVACIONES
 Bandeja de aluminio	Puede causar arcos eléctricos. Transfiera la comida a un plato apto para microondas. 
 Cartón de comida con asa de metal	Puede causar arcos eléctricos. Transfiera la comida a un plato apto para microondas. 
 Utensilios de metal o con adornos de metal	El metal protege los alimentos de la energía de microondas. Las molduras metálicas pueden provocar arcos eléctricos. 
 Lazos de torsión de metal	Puede provocar un arco eléctrico y un incendio en el horno. 
 Bolsas de papel	Puede provocar un incendio en el horno. 
 Espuma plástica	La espuma plástica puede derretir o contaminar el líquido del interior cuando se expone a altas temperaturas. 
 Madera	La madera se secará cuando se use en el microondas y tendrá posibilidad de partirse o rajarse. 

CONFIGURACIÓN DEL PRODUCTO

PREPARACIÓN DEL HORNO

(En caso de existir diferencias entre el aparato y las imágenes de este manual, prevalecerá el producto).

NOMBRE DE LOS COMPONENTES Y ACCESORIOS DEL HORNO MICROONDAS

Retire el horno y todos los materiales del cartón y de la cavidad del horno.

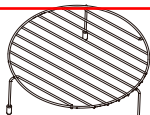

Rejilla superior de la parrilla

Rejilla del grill (no puede utilizarse en la función microondas y debe colocarse en la bandeja de cristal)

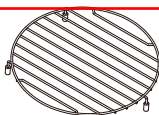

Rejilla inferior de la parrilla

Rejilla del grill (no puede utilizarse en la función microondas y debe colocarse en la bandeja de cristal)

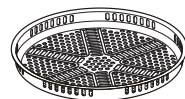

Bandeja para hornear (No puede utilizarse en la función microondas y puede colocarse en la rejilla de la parrilla)



Bandeja de cristal

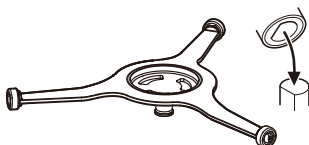

Conjunto de Anillo de Plato Giratorio



Manual de instrucciones

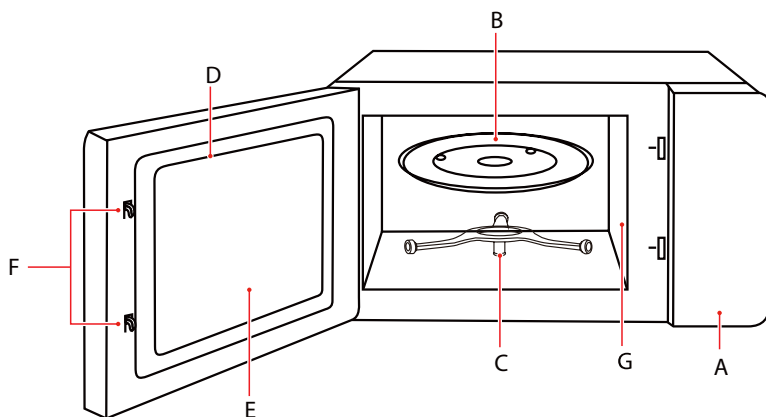

- A) Panel de control
- B) Bandeja de cristal
- C) Conjunto del anillo del plato giratorio
- D) Puerta

- E) Ventana de observación
- F) Sistema de cierre de seguridad
- G) Cubierta de la guía de ondas

PREPARACIÓN DEL HORNO

INSTALACIÓN DEL PLATO GIRATORIO

Limpie el compartimento de cocción y coloque el plato giratorio.

Para las instalaciones nuevas, asegúrese de que todo el embalaje y la cinta hayan sido extraídos del eje del plato giratorio.

Antes de usar el aparato para cocinar alimentos por primera vez, deberá colocar correctamente el plato giratorio en posición. Debe limpiar el compartimento de cocción y los accesorios.

También puede consultar la sección de limpieza.

Cómo colocar el plato giratorio en posición:

1. Coloque el conjunto del aro del plato giratorio ② en el hueco del compartimento de cocción.
2. Coloque la bandeja de cristal ① en el conjunto del aro del plato giratorio ②.

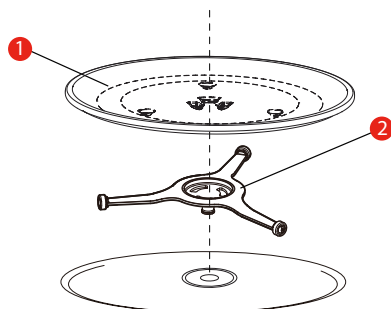

- 1) Bandeja de cristal
- 2) Anillo giratorio

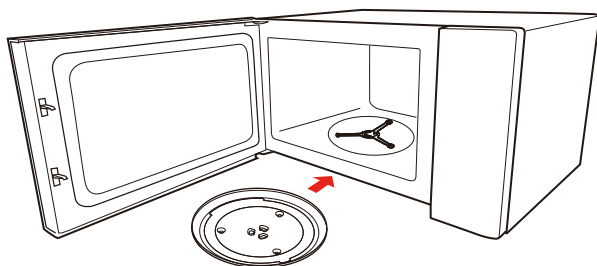

NOTA

- Nunca use el aparato sin el plato giratorio. Asegúrese de que se encuentra instalado correctamente. El plato giratorio puede girar en sentido horario y antihorario.
- Nunca coloque la bandeja de cristal boca abajo. La bandeja de cristal nunca debe confinarse.
- Tanto la bandeja de cristal como el anillo del plato giratorio deben usarse siempre al cocinar.
- Todos los alimentos y recipientes de alimentos se colocan siempre en la bandeja de cristal para cocinarlos.
- Nunca limite el movimiento del plato giratorio.
- Si la bandeja de cristal o el anillo del plato giratorio se agrietan o rompen, póngase en contacto con su centro de servicio autorizado más cercano.

INSTALACIÓN EN LA ENCIMERA

Retire todos los materiales del envase y accesorios. Examine el horno en busca de cualquier daño como melladuras o la puerta rota. No instale el horno si está dañado.

Carcasa: Retire cualquier película protectora que se encuentre en la superficie de la carcasa del horno microondas. No retire la cubierta que está fijada a la cavidad del horno para proteger el magnetrón.

INSTALACIÓN

1. Seleccione una superficie plana que ofrezca suficiente espacio abierto para las ventilaciones de admisión y/o salida.
 - a. La altura mínima de instalación es de 85 cm.
 - b. La parte trasera del aparato debe colocarse contra la pared. Deje un espacio libre mínimo de 30 cm por encima del horno. Es necesario un espacio mínimo de 20 cm entre el horno y cualquier pared adyacente.
 - c. No retire las patas de la parte inferior del horno.
 - d. Bloquear las aperturas de entrada y/o salida puede dañar el horno.
 - e. Coloque el horno lo más alejado posible de radios y televisores. El funcionamiento del horno microondas puede causar interferencias con la recepción de su radio o televisor.

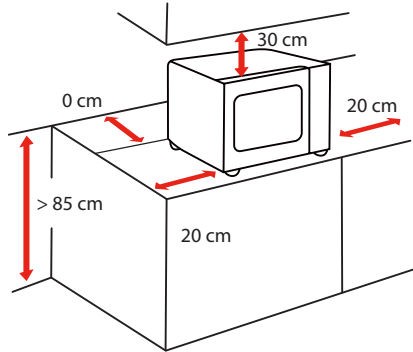

2. Enchufe el horno microondas a una toma doméstica estándar. Asegúrese de que la tensión y la frecuencia son las mismas que la tensión y la frecuencia de la etiqueta de calificación.



NOTA

- No instale el horno sobre una placa de cocina u otros aparatos que produzcan calor. Si se instala cerca o sobre una fuente de calor, se puede dañar el horno y quedará anulada la garantía.

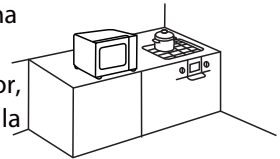

La superficie accesible puede estar caliente durante su funcionamiento.

INSTRUCCIONES DE USO

ANTES DE USARLO POR PRIMERA VEZ

Es normal que el horno produzca olores desagradables cuando se use por primera vez.

Esta sección le dice lo que necesita hacer antes de usar el microondas para preparar alimentos por primera vez. Lea antes la sección titulada «**SEGURIDAD DEL PRODUCTO**».

Antes de que pueda usar el nuevo aparato, será necesario que coloque correctamente en su lugar el plato giratorio. Asimismo, debe limpiar el compartimento de cocción y sus accesorios.



NOTA

- Nunca use el aparato sin el plato giratorio.
- Asegúrese de que esté correctamente acoplado. El plato giratorio puede girar en sentido horario o antihorario.

FUNCIONAMIENTO

PANEL DE CONTROL Y CARACTERÍSTICAS

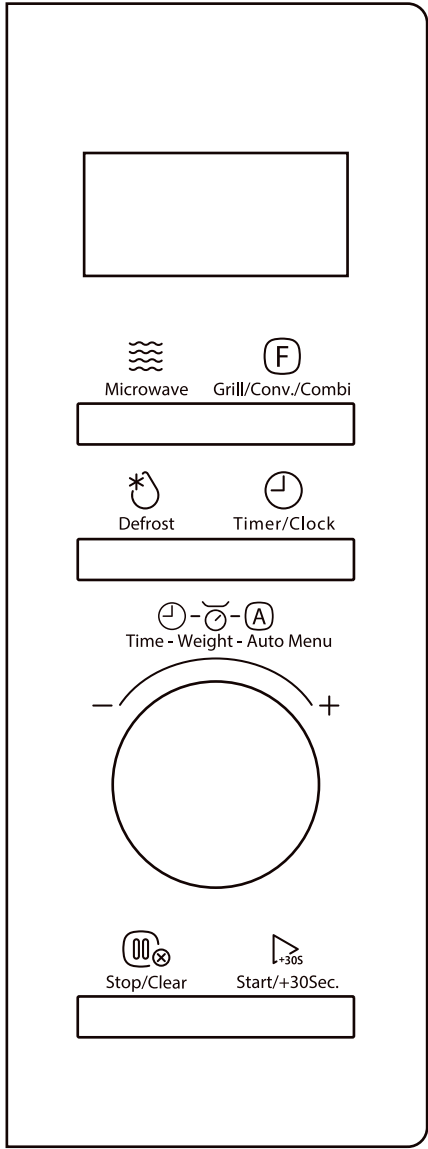

1. NIVELES DE POTENCIA

Dispone de cinco niveles de potencia.

NIVEL	POTENCIA	PANTALLA
1	100 %	P100
2	80 %	P80
3	50 %	P50
4	30 %	P30
5	10 %	P10

2. CONFIGURACIÓN DEL RELOJ

Cuando el horno microondas está conectado a una toma de corriente, se mostrará «00:00».

- a** Pulse  dos veces y aparece «00:00».



- b** Gire el mando giratorio para ajustar los dígitos de la hora; deben estar entre 0-23.

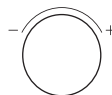

- c** Pulse  o  para confirmar las cifras de las horas.



- d** Gire el mando giratorio para ajustar las cifras de los minutos; debe estar entre 0-59.

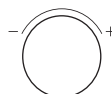

e Pulse  Start/+30Sec. o  Timer/Clock para confirmarlo.



NOTA

- Cuando se encienda el horno, si no se ha configurado el reloj, no funcionará.
- En el proceso de la configuración del reloj, si no se realiza ninguna operación en 5 minutos, pulse  directamente; la pantalla volverá automáticamente a la configuración anterior del reloj.

3. TEMPORIZADOR DE LA COCINA

Quando el horno microondas está conectado a una toma de corriente, se mostrará «0:00».

a Pulse  Timer/Clock una vez.



b Gire el mando giratorio para ajustar la hora; debe estar entre 0:05-95:00.



c Pulse  Start/+30Sec. para empezar la cuenta atrás.













NOTA





- La configuración del temporizador de cocina es diferente a la configuración del reloj; es simplemente un temporizador.
- Durante la función de temporizador de cocina, no se puede configurar para su funcionamiento ninguna función de cocinado.

4. COCINADO CON EL MICROONDAS

Cuando el horno microondas está conectado a una toma de corriente, se mostrará «0:00».

- a** Pulse  más tiempo para elegir el nivel de potencia. 
- a** Pulse  una vez y después gire el mando giratorio para establecer el nivel de potencia.  
- b** Pulse  para confirmar el nivel de potencia. 
- c** Gire el mando giratorio para ajustar el tiempo, el valor máximo de tiempo es de «95:00». 
- d** Pulse  para empezar a cocinar. 

5. PARRILLA O COMBINACIÓN

- a** Pulse  más veces para elegir el modo. 
- a** Pulse  una vez y después gire el mando giratorio para elegir el modo.
«G-1, C-1...C-4, 150 °C, 160 °C.....240 °C» se mostrará en orden. («G-1» es la parrilla, «C-1~C-4» son las combinaciones).  

b Pulse  Start/+30Sec. para confirmar el modo.



c Gire el mando giratorio para ajustar el tiempo, el valor máximo de tiempo es de «95:00».

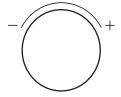

d Pulse  Start/+30Sec. para empezar a cocinar.



NOTA

• Cuando haya transcurrido la mitad del tiempo, sonará el pitido para recordarle que debe darle la vuelta a la comida durante la función de parrilla. Si no hay ninguna operación, el horno continuará funcionando.

6. CONVECCIÓN CON PRECALENTAMIENTO

a Pulse  Grill/Conv./Combi más veces para elegir la temperatura de convección.



a Pulse  Grill/Conv./Combi una vez y después gire el mando giratorio para elegir la temperatura de convección.





150 °C, 160 °C.....240 °C están disponibles.

b Pulse  Start/+30Sec. dos veces para empezar a precalentar. Cuando se complete el precalentamiento, la temperatura parpadeará, abra la puerta e introduzca los alimentos en el horno.

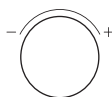

- c** Gire el mando giratorio para ajustar el tiempo, el valor máximo de tiempo es de «95:00».



- d** Pulse  para empezar a cocinar.



7. CONVECCIÓN SIN PRECALENTAMIENTO

- a** Pulse  más veces para elegir la temperatura de convección.



- a** **o** Pulse  una vez y después gire el mando giratorio para elegir la temperatura de convección. 150 °C, 160 °C.....240 °C están disponibles.



- b** Pulse  para confirmar la temperatura.



- c** Gire el mando giratorio para ajustar el tiempo, el valor máximo de tiempo es de «95:00».

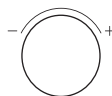



- d** Pulse  para empezar a cocinar.

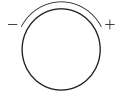

8. MENÚ AIRFRY

- a** En estado de espera, gire el mando giratorio a la derecha para introducir la función del menú.
Gire el mando giratorio repetidamente para elegir el tipo de menú H-1.



- b** Pulse  Start/+30Sec. para confirmar el tipo de menú



- c** Gire el mando regulador para elegir el submenú.

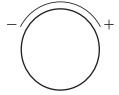

- d** Pulse  Start/+30Sec. para empezar a cocinar.



CUADRO DE MENÚ AIRFRY

PANTALLA	MENÚ	PESO
H-1	Patatas fritas congeladas	300 g
H-2	Croquetas de patatas congeladas	350 g
H-3	Calamar congelado	250 g
H-4	Aros de cebolla congelados	250 g
H-5	Nuggets de pollo congelados	350 g
H-6	Escalope	400 g
H-7	Gambas	250 g
H-8	Verduras	200 g
H-9	Rollitos de primavera	300 g

Nota: No se puede establecer el peso del menú airfry.

9. MENÚ AUTOMÁTICO Y MENÚ DE PARRILLA CRUJIENTE

- a** En estado de espera, gire el mando giratorio a la derecha para introducir la función del menú.
Gire el mando giratorio repetidamente para elegir el menú automático (pantalla A-1) o el menú de la parrilla crujiente (pantalla C-1). Por ejemplo, elija el C-1.

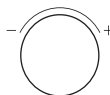

- b** Pulse  Start/+30Sec. para confirmarlo.



- c** Gire el mando giratorio para elegir el submenú, C-1~C-4 están disponibles.



- d** Pulse  Start/+30Sec. para confirmarlo.
Gire el mando giratorio para elegir el peso
No se puede establecer el peso de C-3 y C-4.



- e** Pulse  Start/+30Sec. para confirmarlo.



CUADRO DE MENU DE PARRILLA CRUJIENTE

PANTALLA	MENÚ	PESO
C-1	Cordon bleu	300 g
		600 g
		900 g
C-2	lasaña	200 g
		300 g
		400 g
		500 g
C-3	pan	100 g
C-4	pastel/tarta	8 (unos 350 g)

CUADRO DE MENÚ AUTOMÁTICO

MENÚ	PANTALLA	PESO/ CANTIDAD	NIVEL DE ALIMENTACIÓN
A-1 RECALENTAMIENTO AUTOMÁTICO	150 g	150 g	P100
	250 g	250 g	
	350 g	350 g	
	450 g	450 g	
	600 g	600 g	
A-2 PATATA	1	1 (aproximadamente 230g)	P100
	2	2	
	3	3	
A-3 CARNE	150 g	150 g	P80
	300 g	300 g	
	450 g	450 g	
	600 g	600 g	
A-4 VERDURAS	150 g	150 g	P100
	350 g	350 g	
	500 g	500 g	
A-5 PESCADO	150 g	150 g	P80
	250 g	250 g	
	350 g	350 g	
	450 g	450 g	
	650 g	650 g	
A-6 PASTA	50 g (con agua fría 450 g)	50 g	P80
	100 g (con agua fría 800 g)	100 g	
	150 g (con agua fría 1200 g)	150 g	
A-7 SOPA	200 g	200 g	P100
	400 g	400 g	
	600 g	600 g	
A-8 PASTEL	475 g	475 g	CONVEC.160 °C (Con precalentamiento 160 °C)
A-9 PIZZA	100 g	100 g	C-4
	200 g	200 g	
	300 g	300 g	
A10 POLLO	500 g	500 g	C-4
	750 g	750 g	
	1000 g	1000 g	
	1200 g	1200 g	

10. DESCONGELACIÓN POR PESO

- a** Pulse  Defrost una vez y aparecerá «dEF1».



- b** Gire el mando giratorio para ajustar el peso de los alimentos; debe estar entre «100 g-2000 g».

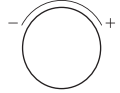

- c** Pulse  Start/+30Sec. para empezar a descongelar.



NOTA

- El pitido sonará dos veces para recordarle que debe darles la vuelta a los alimentos durante la descongelación.

11. TIEMPO DE DESCONGELACIÓN

- a** Pulse dos veces  Defrost; se mostrará «dEF2».



- b** Gire el mando giratorio para establecer la hora, el valor máximo de tiempo es «95:00».

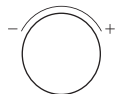

- c** Pulse  Start/+30Sec. para empezar a descongelar.



NOTA

- El pitido sonará para recordarle que debe darles la vuelta a los alimentos cuando haya transcurrido la mitad del tiempo.
- El nivel de potencia predeterminado es de P30 y no puede modificarse..

12. COCCIÓN MULTIFASE

- a** Pulse dos veces  Defrost ; se mostrará «dEF2».



- b** Gire el mando giratorio para ajustar el tiempo, el valor máximo de tiempo es de «95:00».



- c** Pulse  Grill/Conv./Combi para elegir el modo de cocinado.



- d** Pulse  Start/+30Sec. para confirmarlo.



- e Gire el mando giratorio para ajustar el tiempo, el valor máximo de tiempo es de «95:00».

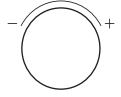

- f Pulse  Start/+30Sec. para empezar a cocinar.



NOTA

- Con el cocinado multifase se pueden establecer dos fases de cocinado.
- Si establece la función de descongelación, se iniciará automáticamente en la primera fase.
- El temporizador de cocina, el menú automático, la cocción rápida y el precalentamiento no pueden establecerse como una de las fases múltiples.

13. VELOCIDAD DE COCINADO

- a Gire el mando giratorio una vez a la izquierda para elegir el modo de cocinado con un nivel de potencia del 100 % durante 5 segundos directamente.

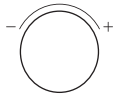

- b Gire el mando giratorio para establecer la hora, el valor máximo de tiempo es «95:00».

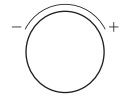

- c Pulse  Start/+30Sec. para empezar a cocinar.



- a Pulse  Start/+30Sec. una vez para cocinar con un nivel de potencia del 100 % con 30 segundos directamente.



14. FUNCIÓN DE BLOQUEO

- a** Para bloquear el microondas de forma que los niños u otros usuarios no intencionados, pulse  durante 3 segundos; se mostrará el icono de bloqueo.



- b** Para desbloquearlo, pulse el botón  durante 3 segundos.



15. FUNCIÓN DE PREGUNTA

- a** Cuando el horno esté cocinando, pulse  Timer/Clock ; aparecerá el tiempo actual durante tres segundos en la pantalla.



LIMPIEZA

Con limpieza y mantenimiento adecuados, su aparato mantendrá plenamente su apariencia durante un largo período de tiempo. Explicaremos a continuación para decirle cómo hacer el mantenimiento y la limpieza de su aparato.



- El vidrio rayado en la puerta del aparato puede convertirse en una rotura. Se prohíbe usar raspadores de vidrio, productos de limpieza o detergentes afilados o abrasivos.
- La superficie del aparato puede ser dañada si no se limpia correctamente. Lo que aumentará la energía de microondas. Limpie el aparato de forma periódica y retire de inmediato los restos de comida.
- No sumerja el aparato en agua ni lo limpie bajo un chorro de agua.

Agente de limpieza

Para asegurarse de que las diferentes superficies no se dañen por el uso de agente de limpieza incorrecto, deberá observarse la siguiente información. Lave bien los paños de esponja nuevos antes de usarlos.

No utilice:



Agentes de limpieza fuertes o abrasivos



Raspadores metálicos o vidrio para limpiar el panel de puertas



Raspadores metálicos o vidrio para limpiar la junta de puerta



Esponjas abrasivas o estropajos duros



Agentes de limpieza con alta graduación alcohólica

PARTE DELANTERA DEL APARATO

Agua jabonosa caliente:

Utilice un paño de cocina para limpiar y luego seque con un paño suave.

No utilice raspadores metálicos o vidrio para la limpieza.

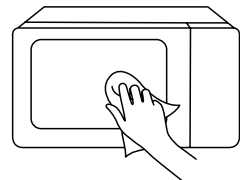

LIMPIEZA

CHAPA DE LA PARTE DELANTERA DEL APARATO

Agua caliente jabonosa:

Utilice un paño de cocina para limpiar y luego seque con un paño suave.

Elimine inmediatamente las salpicaduras y manchas de cal, grasa, almidón y albúmina. La parte inferior de estos parches o salpicaduras puede causar la corrosión. No utilice limpiador de cristales, raspadores metálicos o vidrio para la limpieza.

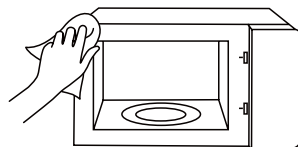

CAVIDAD DEL APARATO

Agua caliente jabonosa o solución de vinagre:

Utilice un paño de cocina para limpiar y luego seque con un paño suave. No utilice aerosol para horno ni ningún otro limpiador de horno agresivo o materiales abrasivos. Las esponjas abrasivas o las esponjas ásperas y los limpiadores de ollas tampoco son idóneos. Estos elementos pueden dañar la superficie. Deje que se sequen completamente las superficies interiores.

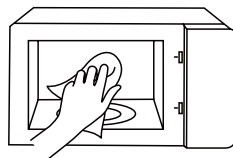

HUECO DE SOPORTE EN EL COMPARTIMENTO DE COCCIÓN

Paño húmedo:

No se permite que entre agua en el aparato debido al movimiento del plato giratorio. Seque el plato giratorio con un paño.

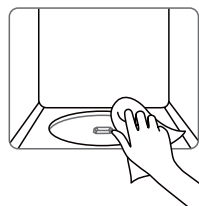

PLATO GIRATORIO Y ANILLO DE RODAMIENTO

Agua caliente jabonosa:

Cuando coloca el plato giratorio en su hueco de soporte, deberá ser la colocación correctamente.



PANEL DE PUERTA

Limpiador de cristales:

Utilice un paño de cocina para limpiar. No utilice raspadores de vidrio.

RESOLUCIÓN DE PROBLEMAS

Verifique su problema utilizando la tabla a continuación y pruebe las soluciones para cada uno. Si el microondas aún no funciona correctamente, comuníquese con el centro de servicio autorizado más cercano.

PROBLEMA	CAUSA POSIBLE	POSIBLE REMEDIO
El horno no arranca	<ul style="list-style-type: none"> a. El cable eléctrico del horno no está enchufado. b. La puerta está abierta. c. Se establece una operación incorrecta. 	<ul style="list-style-type: none"> a. Enchufarlo en el tomacorriente. b. Cerrar la puerta y vuelva a intentarlo. c. Consultar las instrucciones
Formación de arcos o chispas eléctricas	<ul style="list-style-type: none"> a. Se utilizaron materiales prohibidos en el horno microondas. b. El horno funciona cuando está vacío. c. La comida derramada permanece en la cavidad. 	<ul style="list-style-type: none"> a. Utilizar únicamente utensilios de cocina aptos para microondas. b. No operar con el horno vacío. c. Limpiar la cavidad con una toalla húmeda.
Alimentos mal cocidos	<ul style="list-style-type: none"> a. Se utilizaron materiales prohibidos en el horno microondas. b. Los alimentos no se descongelan por completo. c. No son adecuados el tiempo de cocción y el nivel de potencia. d. La comida no se da vuelta ni se revuelve. 	<ul style="list-style-type: none"> a. Utilizar únicamente utensilios de cocina aptos para microondas. b. Descongelar completamente los alimentos. c. Utilizar el tiempo de cocción y el nivel de potencia correctos. d. Voltrear o revuelva la comida.
Alimentos demasiado cocidos	No son adecuados el tiempo de cocción y el nivel de potencia.	Utilizar el tiempo de cocción y el nivel de potencia correctos.
Alimentos poco cocidos	<ul style="list-style-type: none"> a. Se utilizaron materiales prohibidos en el horno microondas. b. Los alimentos no se descongelan por completo. c. Los puertos de ventilación del horno están restringidos. d. No son adecuados el tiempo de cocción y el nivel de potencia. 	<ul style="list-style-type: none"> a. Utilizar únicamente utensilios de cocina aptos para microondas. b. Descongelar completamente los alimentos. c. Verificar que los puertos de ventilación del horno no estén restringidos. d. Utilizar el tiempo de cocción y el nivel de potencia correctos.
Descongelación inadecuada	<ul style="list-style-type: none"> a. Se utilizaron materiales prohibidos en el horno microondas. b. No son adecuados el tiempo de cocción y el nivel de potencia. c. La comida no se da vuelta ni se revuelve. 	<ul style="list-style-type: none"> a. Utilizar únicamente utensilios de cocina aptos para microondas. b. Utilizar el tiempo de cocción y el nivel de potencia correctos. c. Voltrear o revuelva la comida.



De acuerdo con la directiva de Residuos de Aparatos Eléctricos y Electrónicos (RAEE), los residuos de aparatos eléctricos y electrónicos deben recolectarse y tratarse por separado. Si en algún momento en el futuro necesita deshacerse de este producto, NO lo deseché con la basura doméstica. Envíe este producto a los puntos de recogida de residuos de aparatos eléctricos y electrónicos donde estén disponibles.

#DetailsMatter

ΟΔΗΓΙΕΣ ΧΡΗΣΗΣ

ΦΟΥΡΝΟΣ ΜΙΚΡΟΚΥΜΑΤΩΝ

MW3-AC26SF(WH)

Διαβάστε αυτές τις οδηγίες χρήσης πριν από τη λειτουργία.

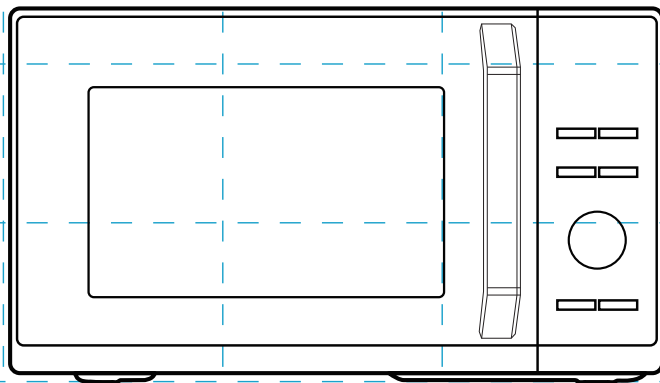

TOSHIBA

ΠΕΡΙΕΧΟΜΕΝΑ

ΑΣΦΑΛΕΙΑ ΠΡΟΪΟΝΤΟΣ

Προφυλάξεις για να αποφύγετε πιθανή έκθεση σε υπερβολική ενέργεια μικροκυμάτων	EL-01
Σημαντικές οδηγίες ασφαλείας	EL-03
Εγκατάσταση γείωσης	EL-08
Καθαρισμός	EL-10
Σκεύη	EL-11
Υλικά που μπορούν να χρησιμοποιηθούν στον φούρνο μικροκυμάτων	EL-12
Υλικά που δεν μπορούν να χρησιμοποιηθούν στον φούρνο μικροκυμάτων	EL-14

ΡΥΘΜΙΣΗ ΠΡΟΪΟΝΤΟΣ

Ρύθμιση του φούρνου σας.....	EL-15
------------------------------	-------

ΟΔΗΓΙΕΣ ΧΡΗΣΗΣ

Πριν από την πρώτη χρήση	EL-18
Χειρισμός.....	EL-19
1. Επίπεδα ισχύος	EL-20
2. Ρύθμιση ρολογιού	EL-20
3. Χρονόμετρο κουζίνας	EL-21
4. Μαγείρεμα με μικροκύματα	EL-22
5. Γκριλ ή συνδυασμοί	EL-22
6. Αέρας με προθέρμανση	EL-23
7. Αέρας χωρίς προθέρμανση.....	EL-24
8. Μενού Φριτέζα αέρα	EL-25
9. Μενού Αυτόματο & Γκριλ για ξεροψημένα	EL-26
10. Απόψυξη βάρους	EL-28
11. Χρόνος απόψυξης.....	EL-28
12. Μαγείρεμα πολλαπλών σταδίων	EL-29

13. Γρήγορο μαγείρεμα.....	EL-30
14. Λειτουργία κλειδώματος	EL-31
15. Λειτουργία πληροφοριών	EL-31

ΚΑΘΑΡΙΣΜΟΣ ΚΑΙ ΣΥΝΤΗΡΗΣΗ

Καθαρισμός.....	EL-32
Αντιμετώπιση προβλημάτων	EL-34



ΣΗΜΕΙΩΣΗ

**ΠΡΙΝ ΧΡΗΣΙΜΟΠΟΙΗΣΕΤΕ ΑΥΤΟ ΤΟ ΠΡΟΙΟΝ,
ΔΙΑΒΑΣΤΕ, ΚΑΤΑΝΟΗΣΤΕ ΚΑΙ ΑΚΟΛΟΥΘΗΣΤΕ ΑΥΤΕΣ
ΤΙΣ ΟΔΗΓΙΕΣ.
ΦΡΟΝΤΙΣΤΕ ΝΑ ΚΡΑΤΗΣΕΤΕ ΤΟ ΠΑΡΟΝ ΕΓΧΕΙΡΙΔΙΟ
ΓΙΑ ΜΕΛΛΟΝΤΙΚΗ ΑΝΑΦΟΡΑ.**

ΑΣΦΑΛΕΙΑ ΠΡΟΪΟΝΤΟΣ

ΠΡΟΦΥΛΑΞΕΙΣ ΑΠΟΦΥΓΗΣ ΠΙΘΑΝΗΣ ΕΚΘΕΣΗΣ ΣΕ ΥΠΕΡΒΟΛΙΚΗ ΕΝΕΡΓΕΙΑ ΜΙΚΡΟΚΥΜΑΤΩΝ

(α). Μην προσπαθήσετε να χρησιμοποιήσετε τον φούρνο με την πόρτα ανοικτή, καθώς αυτό μπορεί να προκαλέσει επιβλαβή έκθεση στην ενέργεια των μικροκυμάτων. Είναι σημαντικό να μην σπάσετε ή παραποιήσετε τα κλειδιά ασφαλείας.

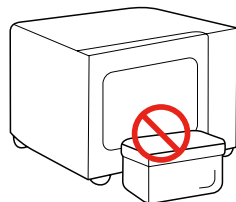

(β). Μην τοποθετείτε αντικείμενα ανάμεσα στην πρόσοψη του φούρνου και την πόρτα και μην αφήνετε να συσσωρεύονται ακαθαρσίες ή υπολείμματα καθαριστικού στις επιφάνειες σφραγίσματος.

(γ). **ΠΡΟΕΙΔΟΠΟΙΗΣΗ:** Εάν η πόρτα ή τα στεγανωτικά υλικά της πόρτας έχουν υποστεί φθορά, μην χρησιμοποιείτε τον φούρνο, μέχρι να επισκευαστεί από ειδικευμένο άτομο.

ΠΑΡΑΡΤΗΜΑ

Εάν η συσκευή δεν διατηρείται καθαρή, η επιφάνειά της μπορεί να υποβαθμιστεί και να επηρεάσει τη διάρκεια ζωής της, οδηγώντας σε πιθανώς επικίνδυνη κατάσταση.

ΠΡΟΔΙΑΓΡΑΦΕΣ

ΜΟΝΤΕΛΟ	MW3-AC26SF(WH)
ΟΝΟΜΑΣΤΙΚΗ ΤΑΣΗ/ΣΥΧΝΟΤΗΤΑ	230-240 V~ 50 Hz
ΟΝΟΜΑΣΤΙΚΗ ΙΣΧΥΣ ΕΙΣΟΔΟΥ (ΜΙΚΡΟΚΥΜΑΤΑ)	1450 W
ΟΝΟΜΑΣΤΙΚΗ ΙΣΧΥΣ ΕΞΟΔΟΥ (ΜΙΚΡΟΚΥΜΑΤΑ)	900 W
ΟΝΟΜΑΣΤΙΚΗ ΙΣΧΥΣ ΕΙΣΟΔΟΥ (ΓΚΡΙΛ)	1000 W
ΟΝΟΜΑΣΤΙΚΗ ΙΣΧΥΣ ΕΙΣΟΔΟΥ (ΑΕΡΑΣ)	2100 W



ΣΗΜΕΙΩΣΗ

Όλες οι εικόνες σε αυτό το εγχειρίδιο παρέχονται μόνο για επεξηγηματικούς σκοπούς. Ενδέχεται να είναι ελαφρώς διαφορετικές από τον εξοπλισμό που αγοράσατε. Ανατρέξτε στο προϊόν σας.

ΣΗΜΑΝΤΙΚΕΣ ΟΔΗΓΙΕΣ ΑΣΦΑΛΕΙΑΣ



ΠΡΟΕΙΔΟΠΟΙΗΣΗ

Για τη μείωση του κινδύνου πυρκαγιάς, ηλεκτροπληξίας, τραυματισμών ή έκθεσης σε υπερβολική ενέργεια μικροκυμάτων, ακολουθείτε τις βασικές προφυλάξεις κατά τη χρήση της συσκευής σας, συμπεριλαμβανομένων των παρακάτω:



Διαβάστε και ακολουθήστε την ενότητα:

«ΠΡΟΦΥΛΑΞΕΙΣ ΓΙΑ ΝΑ ΑΠΟΦΥΓΕΤΕ ΠΙΘΑΝΗ ΈΚΘΕΣΗ ΣΕ ΥΠΕΡΒΟΛΙΚΗ ΕΝΕΡΓΕΙΑ ΜΙΚΡΟΚΥΜΑΤΩΝ».



Η συσκευή μπορεί να χρησιμοποιηθεί από παιδιά ηλικίας άνω των 8 ετών και άτομα με μειωμένες σωματικές, αισθητηριακές ή νοητικές ικανότητες ή έλλειψη εμπειρίας και γνώσεων, εφόσον τους παρέχεται επίβλεψη ή καθοδήγηση σχετικά με τη χρήση της συσκευής με ασφαλή τρόπο και εφόσον κατανοούν τους εμπλεκόμενους κινδύνους. Τα παιδιά δεν πρέπει να παίζουν με τη συσκευή.



η συντήρηση της συσκευής δεν πρέπει να πραγματοποιείται από παιδιά χωρίς επίβλεψη.



Διατηρείτε τη συσκευή και το καλώδιό της μακριά από παιδιά κάτω των 8 ετών.





Εάν το καλώδιο ρεύματος έχει υποστεί βλάβη, θα πρέπει να αντικατασταθεί από τον κατασκευαστή, τον εκπρόσωπο σέρβις ή άτομα με παρόμοια προσόντα για την αποφυγή κινδύνων.



ΠΡΟΕΙΔΟΠΟΙΗΣΗ:
Βεβαιωθείτε ότι η συσκευή είναι απενεργοποιημένη πριν αντικαταστήσετε τη λάμπα, για την αποφυγή της πιθανότητας ηλεκτροπληξίας.

ΣΗΜΑΝΤΙΚΕΣ ΟΔΗΓΙΕΣ ΑΣΦΑΛΕΙΑΣ

 **ΠΡΟΕΙΔΟΠΟΙΗΣΗ:** Η πραγματοποίηση εργασιών σέρβις ή επισκευής είναι επικίνδυνη από μη ειδικευμένα άτομα, συμπεριλαμβανομένης της αφαίρεσης του καλύμματος που παρέχει προστασία από την έκθεση στην ενέργεια μικροκυμάτων.

 **ΠΡΟΕΙΔΟΠΟΙΗΣΗ:** Τα υγρά και λοιπά τρόφιμα δεν πρέπει να θερμαίνονται σε σφραγισμένα δοχεία, αφού υπάρχει κίνδυνος έκρηξης.

 Κατά τη θέρμανση φαγητού σε πλαστικά ή χάρτινα δοχεία, προσέχετε τον φούρνο, λόγω της πιθανότητας ανάφλεξης.

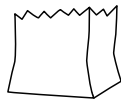

 Χρησιμοποιείτε μόνο σκεύη κατάλληλα για χρήση σε φούρνους μικροκυμάτων.

 Σε περίπτωση εκπομπής καπνού, απενεργοποιήστε ή αποσυνδέστε από την πρίζα τη συσκευή και διατηρήστε την πόρτα κλειστή, για να κατασταλούν τυχόν φλόγες.

 Η θέρμανση ροφημάτων σε φούρνο μικροκυμάτων μπορεί να προκαλέσει καθυστερημένη βράση, γι' αυτό θα πρέπει να προσέχετε κατά τον χειρισμό του δοχείου.

 Το περιεχόμενο μπιμπερό και βάζων βρεφικής τροφής πρέπει να αναδεύεται ή να ανακινείται, καθώς και να ελέγχεται η θερμοκρασία του πριν την κατανάλωση, για την αποφυγή εγκαυμάτων.

ΣΗΜΑΝΤΙΚΕΣ ΟΔΗΓΙΕΣ ΑΣΦΑΛΕΙΑΣ

 Ο φούρνος πρέπει να καθαρίζεται τακτικά, αφαιρώντας τυχόν υπολείμματα τροφίμων. Διατηρείτε καθαρή την περιοχή του θαλάμου φούρνου. Χρησιμοποιήστε ένα μαλακό υγρό πανί για να καθαρίσετε όταν υπάρχουν υπολείμματα φαγητού στην περιοχή του θαλάμου φούρνου. Σε περίπτωση που δεν καθαριστούν τα υπολείμματα φαγητού, ενδέχεται να προκληθεί αβλαβής σπινθήρας ή να εμφανιστεί καπνός στον θάλαμο του φούρνου, καθώς επίσης και αποχρωματισμός του θαλάμου.

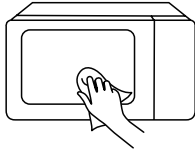

 Εάν ο φούρνος δεν διατηρείται καθαρός, η επιφάνειά του μπορεί να υποστεί φθορά, επηρεάζοντας αρνητικά τη διάρκεια ζωής της συσκευής και οδηγώντας πιθανώς σε επικίνδυνες συνθήκες.

 Χρησιμοποιείτε μόνο τον αισθητήρα θερμοκρασίας που συνιστάται για τον συγκεκριμένο φούρνο. (για φούρνους που διαθέτουν δυνατότητα χρήσης αισθητήρα θερμοκρασίας.)

 Ο φούρνος μικροκυμάτων πρέπει να χρησιμοποιείται με ανοικτή τη διακοσμητική πόρτα. (για φούρνους με διακοσμητική πόρτα)

 Αυτή η συσκευή προορίζεται για οικιακή χρήση και για παρόμοιες εφαρμογές όπως:

1. προσωπικό κουζίνας σε καταστήματα, γραφεία και άλλα επαγγελματικά περιβάλλοντα,
2. χρήση από πελάτες σε ξενοδοχεία, μοτέλ, πανσιόν και άλλα περιβάλλοντα οικιακού τύπου,
3. -αγροικίες,
4. πανσιόν.

ΣΗΜΑΝΤΙΚΕΣ ΟΔΗΓΙΕΣ ΑΣΦΑΛΕΙΑΣ

 Ο φούρνος μικροκυμάτων παρέχεται για τη θέρμανση τροφίμων και ροφημάτων. Η αποξήρανση τροφίμων ή το στέγνωμα ρούχων και η θέρμανση θερμοφόρων, παντοφλών, σφουγγαριών, υγρών πανιών και παρόμοιων αντικειμένων μπορεί να προκαλέσει κίνδυνο τραυματισμού, ανάφλεξης ή φωτιάς.

 Η συσκευή προορίζεται για χρήση χωρίς εντοιχισμό.

 Η πίσω επιφάνεια της συσκευής πρέπει να τοποθετηθεί σε τοίχο.

 Οι επιφάνειες της συσκευής μπορεί να θερμανθούν πολύ κατά τη λειτουργία της.

 **ΠΡΟΕΙΔΟΠΟΙΗΣΗ:** Όταν η συσκευή λειτουργεί στη λειτουργία συνδυασμού, τα

παιδιά πρέπει να χρησιμοποιούν τον φούρνο μόνο υπό την επίβλεψη ενηλίκων λόγω των θερμοκρασιών που δημιουργούνται.

 Αυγά μέσα στο τσόφλι τους και ολόκληρα βραστά αυγά δεν πρέπει να θερμαίνονται σε φούρνους μικροκυμάτων, αφού υπάρχει κίνδυνος έκρηξης, ακόμη και μετά την ολοκλήρωση της θέρμανσής τους.

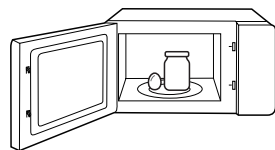



 Η συσκευή δεν πρέπει να τοποθετείται πίσω από πόρτες ντουλαπιών, για την αποφυγή υπερθέρμανσης. (Αυτό δεν ισχύει για συσκευές που διαθέτουν πόρτα ντουλαπιού)

ΣΗΜΑΝΤΙΚΕΣ ΟΔΗΓΙΕΣ ΑΣΦΑΛΕΙΑΣ

 Ο φούρνος μικροκυμάτων δεν πρέπει να τοποθετείται σε ντουλάπι, εκτός εάν έχει δοκιμαστεί σε ντουλάπι.

 Δεν επιτρέπεται η τοποθέτηση μεταλλικών δοχείων τροφίμων και ροφημάτων στον φούρνο μικροκυμάτων.

 Μην καθαρίζετε τη συσκευή με καθαριστή ατμού.

 Οι συσκευές δεν προορίζονται για λειτουργία μέσω εξωτερικού χρονοδιακόπτη ή ξεχωριστού συστήματος τηλεχειρισμού.

ΔΙΑΒΑΣΤΕ ΠΡΟΣΕΚΤΙΚΑ ΚΑΙ
ΦΥΛΑΞΤΕ ΤΙΣ ΟΔΗΓΙΕΣ ΓΙΑ
ΜΕΛΛΟΝΤΙΚΗ ΧΡΗΣΗ

Για να μειώσετε τον κίνδυνο τραυματισμού. Εγκατάσταση γείωσης

Αυτή η συσκευή πρέπει να είναι γειωμένη. Σε περίπτωση βραχυκυκλώματος, η γείωση μειώνει τον κίνδυνο ηλεκτροπληξίας, καθώς παρέχει ένα καλώδιο διαφυγής για το ηλεκτρικό ρεύμα. Αυτή η συσκευή είναι εξοπλισμένη με καλώδιο με φως που διαθέτει γείωση. Το φως πρέπει να είναι συνδεδεμένο σε μια πρίζα σωστά τοποθετημένη και γειωμένη.

ΠΡΟΕΙΔΟΠΟΙΗΣΗ - Η ακατάλληλη χρήση της γείωσης μπορεί να οδηγήσει σε κίνδυνο ηλεκτροπληξίας. Συμβουλευτείτε έναν εξειδικευμένο ηλεκτρολόγο ή συντηρητή εάν οι οδηγίες γείωσης δεν είναι πλήρως κατανοητές ή εάν υπάρχουν αμφιβολίες για το αν η συσκευή είναι σωστά γειωμένη.

Εάν απαιτείται να χρησιμοποιήσετε μπαλαντέζα, χρησιμοποιήστε μόνο μπαλα-ντέζα που έχει 3 καλώδια (ουδέτερο- φάση- γείωση).



ΚΙΝΔΥΝΟΣ

Κίνδυνος ηλεκτροπληξίας:

Το άγγιγμα ορισμένων από τα εσωτερικά εξαρτήματα μπορεί να προκαλέσει σοβαρό τραυματισμό ή θάνατο. Μην αποσυναρμολογείτε αυτή τη συσκευή.

ΓΙΑ ΝΑ ΜΕΙΩΘΕΙ Ο ΚΙΝΔΥΝΟΣ ΤΡΑΥΜΑΤΙΣΜΟΥ ΕΓΚΑΤΑΣΤΑΣΗ ΓΕΙΩΣΗΣ



**ΠΡΟΕΙΔΟΠ
ΟΙΗΣΗ**

Κίνδυνος ηλεκτροπληξίας:

Η ακατάλληλη χρήση της γείωσης μπορεί να προκαλέσει ηλεκτροπληξία. Μην συνδέετε το φως στην πρίζα μέχρι η συσκευή να εγκατασταθεί και να γειωθεί σωστά.

1. Παρέχεται ένα κοντό καλώδιο τροφοδοσίας για τη μείωση των κινδύνων που προκύπτουν από το να μπλέξετε ή να σκοντάψετε σε ένα μακρύτερο καλώδιο.
2. Εάν χρησιμοποιείται μακρύ καλώδιο ή :
 - (1). Η ονομαστική ισχύς που μπορεί να δεχτεί η μπαλαντέζα πρέπει να είναι μεγαλύτερη από την ισχύ της συσκευής
 - (2). Η μπαλαντέζα θα πρέπει να διαθέτει 3 καλώδια (ουδέτερο-φάση- γείωση)
 - (3). Το μακρύτερο καλώδιο θα πρέπει να είναι τοποθετημένο έτσι ώστε να μην κρέμεται πάνω από τον πάγκο ή το τραπέζι όπου μπορεί να τραβηχτεί από παιδιά ή να σκοντάψουν ακούσια.

ΚΑΘΑΡΙΣΜΟΣ

Βεβαιωθείτε ότι έχετε αποσυνδέσει τη συσκευή από την παροχή ρεύματος.

1. Καθαρίστε την κοιλότητα του φούρνου μετά τη χρήση με ένα ελαφρώς υγρό πανί.
2. Καθαρίστε τα εξαρτήματα με τον συνήθη τρόπο σε σαπουνόνερο.
3. Το πλαίσιο της πόρτας και τα γειτονικά εξαρτήματα θα πρέπει να καθαρίζονται προσεκτικά με ένα νοτισμένο πανί.
4. Μην χρησιμοποιείτε σκληρά λειαντικά καθαριστικά ή αιχμηρές μεταλλικές ξύστρες για να καθαρίσετε το γυαλί της πόρτας του φούρνου, καθώς μπορεί να χαράξουν την επιφάνεια, με αποτέλεσμα να σπάσει το γυαλί.
5. Συμβουλή για τον καθαρισμό---Για πιο εύκολο καθαρισμό του εσωτερικού του φούρνου: Βάλτε μισό λεμόνι σε ένα μπολ, προσθέστε 300ml νερό και ζεστάνετε με ισχύ 100% στο φούρνο μικροκυμάτων για 10 λεπτά. Σκουπίστε το φούρνο χρησιμοποιώντας ένα απαλό, στεγνό πανί.

ΣΚΕΥΗ



ΠΡΟΣΟΧΗ

Κίνδυνος προσωπικού τραυματισμού:
Είναι επικίνδυνο για οποιονδήποτε άλλον εκτός από αρμόδιο άτομο να εκτελεί οποιαδήποτε εργασία σέρβις ή επισκευής που περιλαμβάνει την αφαίρεση ενός καλύμματος που παρέχει προστασία από την έκθεση σε ενέργεια μικροκυμάτων. **Ανατρέξτε στις οδηγίες «Υλικά που μπορείτε να χρησιμοποιήσετε σε φούρνο μικροκυμάτων» ή «Υλικά που δεν μπορούν να χρησιμοποιηθούν σε φούρνο μικροκυμάτων».** Ενδέχεται να υπάρχουν ορισμένα μη μεταλλικά σκεύη που δεν είναι ασφαλή για χρήση σε φούρνο μικροκυμάτων. Αν δεν είστε βέβαιοι, μπορείτε να δοκιμάσετε το επιθυμητό σκεύος ακολουθώντας την εξής διαδικασία:

Δοκιμή σκευών:

1. Γεμίστε ένα δοχείο κατάλληλο για φούρνο μικροκυμάτων με 1 φλιτζάνι κρύο νερό (250 ml) μαζί με το εν λόγω σκεύος.
2. Μαγειρέψτε στη μέγιστη ισχύ για 1 λεπτό.
3. Ψηλαφίστε προσεκτικά το σκεύος. Εάν το άδειο σκεύος είναι ζεστό, μην το χρησιμοποιήσετε για μαγείρεμα σε φούρνο μικροκυμάτων.
4. Μην υπερβαίνετε τον χρόνο μαγειρέματος του 1 λεπτού.

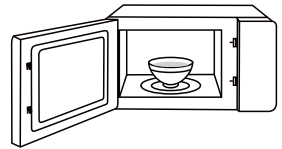

ΣΗΜΕΙΩΣΗ

ΔΙΑΤΗΡΕΙΤΕ ΤΗΝ ΚΟΙΛΟΤΗΤΑ ΚΑΙ ΤΗΝ ΠΕΡΙΟΧΗ ΤΟΥ ΚΥΜΑΤΟΔΗΓΟΥ ΚΑΘΑΡΗ

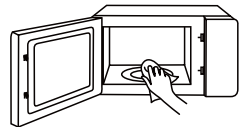

ΥΛΙΚΑ ΠΟΥ ΜΠΟΡΕΙΤΕ ΝΑ ΧΡΗΣΙΜΟΠΟΙΗΣΕΤΕ ΣΕ ΦΟΥΡΝΟ ΜΙΚΡΟΚΥΜΑΤΩΝ

ΣΚΕΥΗ

ΠΑΡΑΤΗΡΗΣΕΙΣ



Πυρέξ

Ακολουθείτε τις οδηγίες του κατασκευαστή. Ο πυθμένας του Πυρέξ πρέπει να βρίσκεται τουλάχιστον 3/16 ίντσας (5 mm) πάνω από τον περιστρεφόμενο δίσκο. Η λανθασμένη χρήση μπορεί να προκαλέσει το σπάσιμο του περιστρεφόμενου δίσκου.



Σερβίτσια

Μόνο ειδικά για φούρνους μικροκυμάτων. Ακολουθείτε τις οδηγίες του κατασκευαστή. Μην χρησιμοποιείτε ραγισμένα ή σπασμένα σκεύη.



Γυάλινα βάζα

Αφαιρείτε πάντα το καπάκι. Χρησιμοποιήστε τον μόνο για να ζεστάνετε το φαγητό μέχρι να είναι μόλις ζεστό. Τα περισσότερα γυάλινα βάζα δεν είναι ανθεκτικά στη θερμότητα και μπορεί να σπάσουν.



Γυάλινα σκεύη

Μόνο γυάλινα σκεύη φούρνου ανθεκτικά στη θερμότητα. Βεβαιωθείτε ότι δεν υπάρχουν μεταλλικά διακοσμητικά στοιχεία. Μην χρησιμοποιείτε ραγισμένα ή σπασμένα σκεύη.



Σακούλες μαγειρέματος φούρνου

Ακολουθείτε τις οδηγίες του κατασκευαστή. Μην κλείνετε με μεταλλικά πιαστράκια. Κάντε σχισμές για να επιτρέψει τη διαφυγή του ατμού.



Χάρτινα πιάτα και ποτήρια

Χρήση μόνο για βραχυπρόθεσμο μαγείρεμα/ζέσταμα. Μην αφήνετε τον φούρνο χωρίς επίβλεψη κατά τη διάρκεια του μαγειρέματος.



Χαρτοπετσέτες

Χρησιμοποιήστε τη για να καλύψετε τρόφιμα για αναθέρμανση και απορρόφηση λίπους. Χρησιμοποιήστε το με επίβλεψη μόνο για βραχυπρόθεσμο μαγείρεμα.



Λαδόκολλα

Χρησιμοποιήστε το ως κάλυμμα για να αποφύγετε το πιτσίσισμα ή ως περιτύλιγμα για το μαγείρεμα στον ατμό.



ΥΛΙΚΑ ΠΟΥ ΜΠΟΡΕΙΤΕ ΝΑ ΧΡΗΣΙΜΟΠΟΙΗΣΕΤΕ ΣΕ ΦΟΥΡΝΟ ΜΙΚΡΟΚΥΜΑΤΩΝ

ΣΚΕΥΗ

ΠΑΡΑΤΗΡΗΣΕΙΣ



Πλαστικό

Μόνο ασφαλή για μικροκύματα. Ακολουθείτε τις οδηγίες του κατασκευαστή. Θα πρέπει να φέρει την ένδειξη «Microwave Safe» (Ασφαλής για μικροκύματα). Ορισμένα πλαστικά δοχεία μαλακώνουν, καθώς το φαγητό μέσα τους ζεσταίνεται. Οι «σακούλες βρασμού» και οι ερμητικά κλειστές πλαστικές σακούλες πρέπει να σχίζονται, να τρυπιούνται ή να αερίζονται σύμφωνα με τις οδηγίες της συσκευασίας.



Πλαστικό περιτύλιγμα

Μόνο ασφαλή για μικροκύματα. Χρησιμοποιήστε το για να καλύψετε τα τρόφιμα κατά τη διάρκεια του μαγειρέματος για να διατηρήσετε την υγρασία. Μην αφήνετε τη μεμβράνη να αγγίζει το φαγητό.

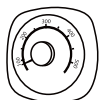

Θερμόμετρα

Μόνο για θερμόμετρα που είναι ασφαλή για μικροκύματα (θερμόμετρα κρέατος και γλυκών).



Κηρόχαρτο

Χρησιμοποιήστε το ως κάλυμμα για να αποφύγετε το πιτσίσισμα και να διατηρήσετε την υγρασία.



ΤΑ ΥΛΙΚΑ ΔΕΝ ΜΠΟΡΟΥΝ ΝΑ ΧΡΗΣΙΜΟΠΟΙΗΘΟΥΝ ΣΕ ΦΟΥΡΝΟ ΜΙΚΡΟΚΥΜΑΤΩΝ

ΣΚΕΥΗ

ΠΑΡΑΤΗΡΗΣΕΙΣ

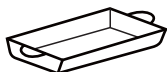

Δίσκος αλουμινίου

Μπορεί να προκληθεί ηλεκτρικό τόξο. Μεταφέρετε το φαγητό σε σκεύος ασφαλές για μικροκύματα.



Σκεύος τροφίμων με μεταλλική λαβή

Μεταφέρετε το φαγητό σε σκεύος ασφαλές για μικροκύματα.



Μέταλλο ή σκεύη με μεταλλική διακόσμηση

Το μέταλλο προστατεύει το φαγητό από την ενέργεια των μικροκυμάτων. Η μεταλλική διακόσμηση μπορεί να προκαλέσει ηλεκτρικό τόξο.



Πλαστικοποιημένο σύρμα – μεταλλικά πιαστράκια

Μπορεί να προκληθεί ηλεκτρικό τόξο και φωτιά στο εσωτερικό του φούρνου μικροκυμάτων.

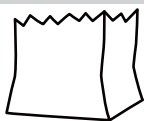

Χάρτινες σακούλες

Ενδέχεται να προκαλέσει φωτιά στον φούρνο.



Πλαστικός αφρός

Ο πλαστικός αφρός μπορεί να λιώσει ή να μολύνει το υγρό στο εσωτερικό του όταν εκτεθεί σε υψηλή θερμοκρασία.



Ξύλο

Το ξύλο ξηραίνεται όταν χρησιμοποιείται στον φούρνο μικροκυμάτων και μπορεί να σπάσει ή να ραγίσει.



ΡΥΘΜΙΣΗ ΠΡΟΙΟΝΤΟΣ

Ρ'ΥΘΜΙΣΗ ΤΟΥ ΦΟΥΡΝΟΥ ΣΑΣ

(Σε περίπτωση διαφορών μεταξύ της συσκευής και των εικόνων στο παρόν εγχειρίδιο, υπερισχύει το προϊόν).

ΟΝΟΜΑΤΑ ΕΞΑΡΤΗΜΑΤΩΝ ΚΑΙ ΑΞΕΣΟΥΡΑ ΦΟΥΡΝΟΥ ΜΙΚΡΟΚΥΜΑΤΩΝ

Αφαιρέστε τον φούρνο και όλα τα υλικά από το χαρτοκιβώτιο και το εσωτερικό του φούρνου.

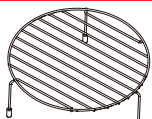

Υψηλότερη σάρα γκριλ

Σάρα γκριλ (δεν μπορεί να χρησιμοποιηθεί σε λειτουργία μικροκυμάτων και πρέπει να τοποθετηθεί στον γυάλινο δίσκο)

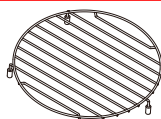

Κάτω σάρα γκριλ

Σάρα γκριλ (δεν μπορεί να χρησιμοποιηθεί σε λειτουργία μικροκυμάτων και πρέπει να τοποθετηθεί στον γυάλινο δίσκο)

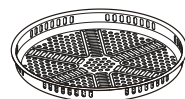

Δίσκος ψησίματος (δεν μπορεί να χρησιμοποιηθεί σε συνδυασμό με τη λειτουργία μικροκυμάτων και μπορεί να τοποθετηθεί στη σάρα γκριλ)

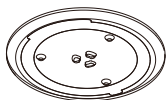

Γυάλινος δίσκος

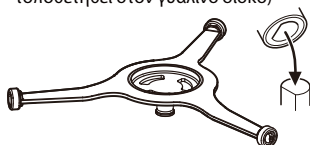

Διάταξη δακτυλίου περιστρεφόμενου δίσκου



Οδηγίες χρήσης

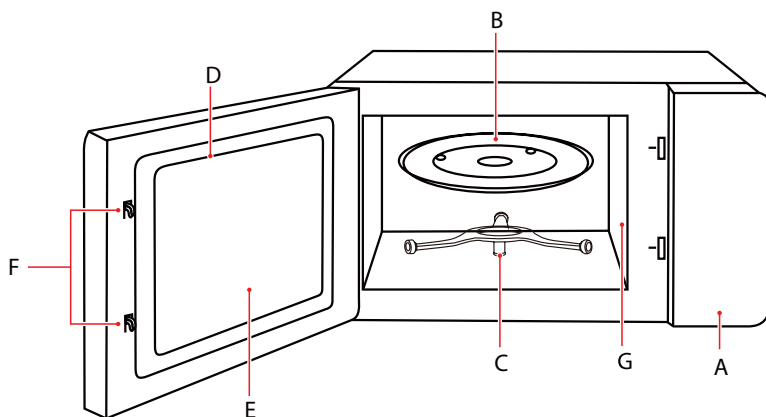

A) Πίνακας ελέγχου

B) Γυάλινος δίσκος

C) Διάταξη δακτυλίου περιστρεφόμενου δίσκου

D) Διάταξη πόρτας

E) Παράθυρο παρατήρησης

F) Σύστημα κλειδώματος ασφαλείας

G) Κάλυμμα θαλάμου φούρνου

ΡΥΘΜΙΣΗ ΤΟΥ ΦΟΥΡΝΟΥ ΣΑΣ

ΕΓΚΑΤΑΣΤΑΣΗ ΠΕΡΙΣΤΡΕΦΟΜΕΝΟΥ ΔΙΣΚΟΥ

Καθαρίστε τον θάλαμο μαγειρέματος και τοποθετήστε τον περιστρεφόμενο δίσκο στη θέση του. Για νέες εγκαταστάσεις, βεβαιωθείτε ότι έχει αφαιρεθεί η ταινία συσκευασίας και αποστολής από τον άξονα του περιστρεφόμενου δίσκου.

Προτού χρησιμοποιήσετε τη συσκευή για να προετοιμάσετε φαγητό για πρώτη φορά, πρέπει να τοποθετήσετε τον περιστρεφόμενο δίσκο σωστά στη θέση του. Πρέπει να καθαρίσετε τον θάλαμο μαγειρέματος και τα αξεσουάρ. Μπορείτε επίσης να τους παραπέμψετε στην ενότητα καθαρισμού.

Πώς να τοποθετήσετε τον περιστρεφόμενο δίσκο στη θέση του:

1. Τοποθετήστε τη διάταξη δακτυλίου του περιστρεφόμενου δίσκου ② στην εσοχή στον θάλαμο μαγειρέματος.
2. Τοποθετήστε τον γυάλινο δίσκο ① στις διατάξεις δακτυλίου του περιστρεφόμενου δίσκου ②.

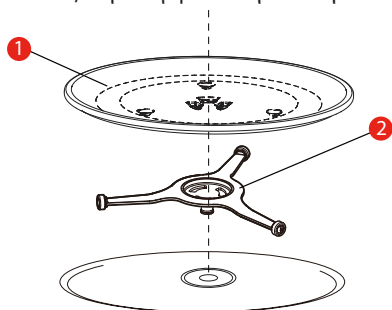

1) Γυάλινος δίσκος

2) Διάταξη δακτυλίου περιστρεφόμενου δίσκου

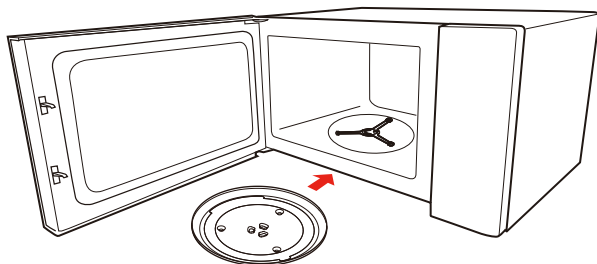

ΣΗΜΕΙΩΣΗ

- Μην χρησιμοποιείτε ποτέ τη συσκευή χωρίς τον περιστρεφόμενο δίσκο. Βεβαιωθείτε ότι ο δίσκος έχει τοποθετηθεί σωστά. Ο δίσκος μπορεί να περιστραφεί δεξιόστροφα ή αριστερόστροφα.
- Μην τοποθετείτε ποτέ ανάποδα τον γυάλινο δίσκο. Ο γυάλινος δίσκος δεν πρέπει ποτέ να περιορίζεται.
- Ο γυάλινος δίσκος και η διάταξη δακτυλίου περιστρεφόμενου δίσκου πρέπει να χρησιμοποιούνται πάντα κατά το μαγείρεμα.
- Όλα τα τρόφιμα και τα δοχεία τροφίμων πρέπει να τοποθετούνται πάντα στον γυάλινο δίσκο για μαγείρεμα.
- Μην περιορίζετε ποτέ την κίνηση του περιστρεφόμενου δίσκου.
- Σε περίπτωση που ο γυάλινος δίσκος ή η διάταξη δακτυλίου περιστρεφόμενου δίσκου ραγίσουν ή σπάσουν, επικοινωνήστε με το πλησιέστερο εξουσιοδοτημένο κέντρο σέρβις.

ΕΓΚΑΤΑΣΤΑΣΗ ΣΕ ΠΑΓΚΟ

Αφαιρέστε όλα τα υλικά συσκευασίας και τα εξαρτήματα. Επιθεωρήστε τον φούρνο για τυχόν ζημιές, όπως χτυπήματα ή σπασμένη πόρτα. Μην εγκαθιστάτε αν ο φούρνος παρουσιάζει φθορά. Ντουλάπι: Αφαιρέστε τυχόν προστατευτική μεμβράνη που βρίσκεται στην επιφάνεια του ντουλαπιού του φούρνου μικροκυμάτων. Μην αφαιρέσετε το κάλυμμα που είναι προσαρτημένο στον θάλαμο του φούρνου για την προστασία του μαγνητρόνιου.

ΕΓΚΑΤΑΣΤΑΣΗ

1. Επιλέξτε μια επίπεδη επιφάνεια που παρέχει αρκετό ελεύθερο χώρο για τις σπές εισόδου ή/και εξόδου αέρα.
 - a. Το ελάχιστο ύψος εγκατάστασης είναι 85cm.
 - b. Η πίσω επιφάνεια της συσκευής πρέπει να τοποθετείται σε τοίχο. Αφήστε ελάχιστο διάκενο 30 cm πάνω από τον φούρνο. Απαιτείται ελάχιστο διάκενο 20 cm μεταξύ του φούρνου και τυχόν παρακείμενων τοίχων.
 - c. Μην αφαιρείτε τα πόδια από το κάτω μέρος του φούρνου.
 - d. Τυχόν μπλοκάρισμα των οπών εισόδου ή/και εξόδου αέρα ενδέχεται να προκαλέσει ζημιά στον φούρνο.
 - e. Τοποθετήστε τον φούρνο όσο το δυνατόν πιο μακριά από ραδιόφωνα και τηλεοράσεις. Η λειτουργία του φούρνου μικροκυμάτων ενδέχεται να προκαλέσει παρεμβολές στο σήμα ραδιοφώνου ή τηλεόρασης.

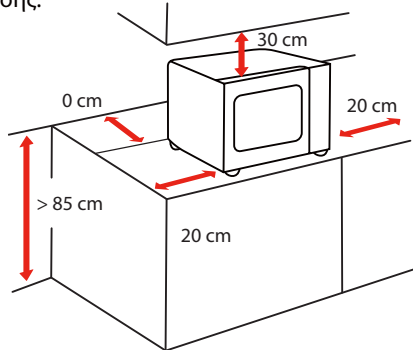

2. Τοποθετήστε το καλώδιο τροφοδοσίας του φούρνου μικροκυμάτων στην πρίζα. Βεβαιωθείτε ότι η τάση και η συχνότητα είναι ίδια με την τάση και τη συχνότητα που αναγράφονται στην ετικέτα χαρακτηριστικών.



• Μην εγκαθιστάτε τον φούρνο πάνω από εστία ή άλλη συσκευή που παράγει θερμότητα. Σε περίπτωση εγκατάστασης κοντά ή πάνω από πηγή θερμότητας, ο φούρνος ενδέχεται να υποστεί ζημιά, στην οποία περίπτωση η εγγύηση θα ακυρωθεί.

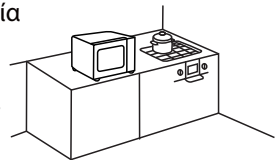

Οι προσβάσιμες επιφάνειες ενδέχεται να υπερθερμανθούν κατά τη διάρκεια της λειτουργίας της συσκευής

ΠΡΙΝ ΑΠΟ ΤΗΝ ΠΡΩΤΗ ΧΡΗΣΗ

Η συσκευή μπορεί να αναδίδει δυσάρεστες οσμές κατά την πρώτη χρήση και αυτό είναι φυσιολογικό.

Αυτή η ενότητα παρέχει πληροφορίες για αυτά που πρέπει να κάνετε προτού χρησιμοποιήσετε τον φούρνο μικροκυμάτων σας για να προετοιμάσετε φαγητό για πρώτη φορά. Διαβάστε προηγουμένως την ενότητα με τίτλο «**ΠΛΗΡΟΦΟΡΙΕΣ ΑΣΦΑΛΕΙΑΣ**».

Προτού χρησιμοποιήσετε τη νέα σας συσκευή, θα πρέπει να τοποθετήσετε σωστά τον περιστρεφόμενο δίσκο. Πρέπει επίσης να καθαρίσετε τον θάλαμο μαγειρέματος και τα αξεσουάρ.



ΣΗΜΕΙΩΣΗ

- Μην χρησιμοποιείτε ποτέ τη συσκευή χωρίς τον περιστρεφόμενο δίσκο.
- Βεβαιωθείτε ότι έχει τοποθετηθεί σωστά. Ο περιστρεφόμενος δίσκος μπορεί να περιστραφεί δεξιόστροφα ή αριστερόστροφα.

ΛΕΙΤΟΥΡΓΙΑ

ΠΙΝΑΚΑΣ ΕΛΕΓΧΟΥ ΚΑΙ ΧΑΡΑΚΤΗΡΙΣΤΙΚΑ

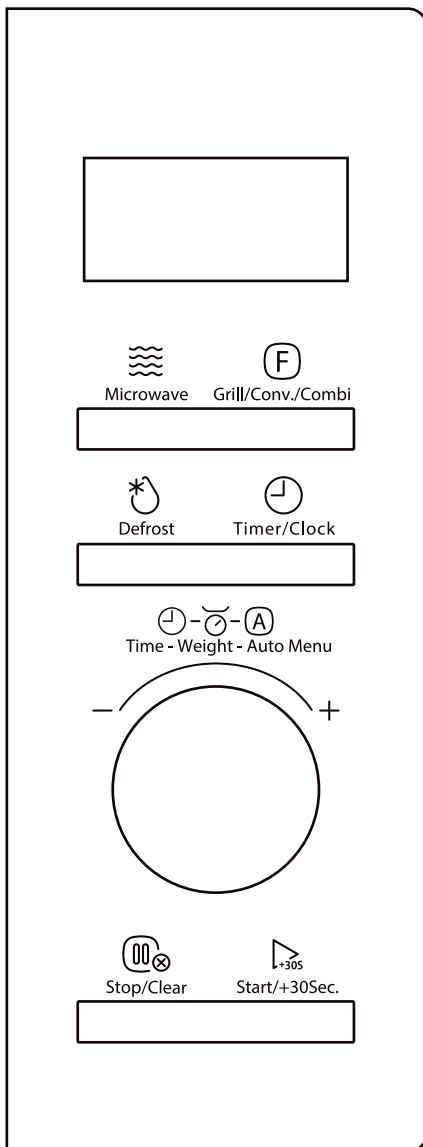

1. ΕΠΙΠΕΔΑ ΙΣΧΥΟΣ

Διατίθενται πέντε επίπεδα ισχύος.

ΙΣΧΥΟΣ	ΕΠΙΠΕΔΟ	ΘΘΟΝΗ
1	100%	P100
2	80%	P80
3	50%	P50
4	30%	P30
5	10%	P10

2. ΡΥΘΜΙΣΗ ΡΟΛΟΓΙΟΥ

Όταν ο φούρνος μικροκυμάτων συνδεθεί σε πρίζα, εμφανίζεται η ένδειξη «0:00».

- a** Πατήστε  Timer/Clock δύο φορές, θα εμφανιστεί η ένδειξη 00:00.



- b** Γυρίστε τον περιστροφικό διακόπτη για να ρυθμίσετε τα ψηφία ώρας, στο εύρος 0-23.



- c** Πατήστε  Start/+30Sec. ή  Timer/Clock για να επιβεβαιώσετε τα στοιχεία ώρας.

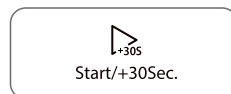

- d** Γυρίστε τον περιστροφικό διακόπτη για να ρυθμίσετε τα ψηφία λεπτών, στο εύρος 0-59.

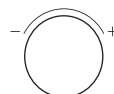

e Πατήστε  Start/+30Sec. ή  Timer/Clock για επιβεβαίωση.



- Όταν ο φούρνος είναι ενεργοποιημένος, δεν θα λειτουργεί εάν δεν έχει ρυθμιστεί το ρολόι.
- Κατά τη διαδικασία ρύθμισης του ρολογιού, εάν δεν πραγματοποιηθεί καμία λειτουργία εντός 5 λεπτών ή εάν πατήσετε  απευθείας, η ένδειξη θα επιστρέψει αυτόματα στην προηγούμενη ρύθμιση του ρολογιού.

3. ΧΡΟΝΟΜΕΤΡΟ ΚΟΥΖΙΝΑΣ

Όταν ο φούρνος μικροκυμάτων συνδεθεί σε πρίζα, εμφανίζεται η ένδειξη «0:00».

a Πατήστε  Timer/Clock μία φορά



b Γυρίστε τον περιστροφικό διακόπτη για να ρυθμίσετε την ώρα, στο εύρος 0:05-95:00.













c Πατήστε  Start/+30Sec. για να ξεκινήσετε την αντίστροφη μέτρηση







- Η ρύθμιση του χρονομέτρου κουζίνας είναι διαφορετική από τη ρύθμιση του ρολογιού. Πρόκειται για χρονοδιακόπτη.
- Κατά τη λειτουργία του χρονομέτρου κουζίνας, δεν μπορεί να επιλεγθεί καμία λειτουργία μαγειρέματος.

4. ΜΑΓΕΪΡΕΜΑ ΜΕ ΜΙΚΡΟΚΥΜΑΤΑ

Όταν ο φούρνος μικροκυμάτων συνδεθεί σε πρίζα, εμφανίζεται η ένδειξη «0:00».

- a** ή
- Πατήστε  Microwave περισσότερες φορές για να επιλέξετε το επίπεδο ισχύος. 
- Πατήστε  Microwave μία φορά και, στη συνέχεια, γυρίστε τον περιστροφικό διακόπτη για να ρυθμίσετε το επίπεδο ισχύος.  
- b** Πατήστε  Start/+30Sec. για να επιβεβαιώσετε το επίπεδο ισχύος. 
- c** Γυρίστε τον περιστροφικό διακόπτη για να ρυθμίσετε την ώρα, η μέγιστη τιμή ώρας είναι «95:00». 
- d** Πατήστε  Start/+30Sec. για να ξεκινήσει το μαγείρεμα. 

5. ΓΚΡΙΛ Ή ΣΥΝΔΥΑΣΜΟΣ

- a** ή
- Πατήστε  Grill/Conv./Combi περισσότερες φορές για να επιλέξετε τη λειτουργία. 
- Πατήστε  Grill/Conv./Combi μία φορά και, στη συνέχεια, περιστρέψτε τον περιστροφικό διακόπτη για να επιλέξετε τη λειτουργία.  
- Θα εμφανιστεί η ένδειξη «G-1, C-1...C-4, 150°C, 160°C.....240°C» με τη σειρά. (το «G-1» είναι το γκριλ, τα «C-1~C-4» είναι συνδυασμοί).

b Πατήστε  Start/+30Sec. για να επιβεβαιώσετε τη λειτουργία.



c Γυρίστε τον περιστροφικό διακόπτη για να ρυθμίσετε την ώρα, η μέγιστη τιμή ώρας είναι «95:00».

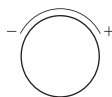

d Πατήστε  Start/+30Sec. για να ξεκινήσει το μαγείρεμα.



ΣΗΜΕΙΩΣΗ

• Αφότου παρέλθει ο μισός χρόνος, ο βομβητής ηχεί προκειμένου να σας υπενθυμίσει να γυρίσετε το φαγητό σε λειτουργία γκριλ. Εάν δεν πραγματοποιηθεί καμία ενέργεια, ο φούρνος θα συνεχίσει να λειτουργεί.

6. ΑΕΡΑΣ ΜΕ ΠΡΟΘΕΡΜΑΝΣΗ

a Πατήστε  Grill/Conv./Combi περισσότερες φορές για να επιλέξετε τη θερμοκρασία αέρα.



a ή Πατήστε  Grill/Conv./Combi μία φορά και, στη συνέχεια, γυρίστε τον περιστροφικό διακόπτη για να επιλέξετε τη θερμοκρασία αέρα.
Οι διαθέσιμες επιλογές είναι 150°C.....240°C.



b Πατήστε  Start/+30Sec. δύο φορές για να ξεκινήσετε την προθέρμανση.
Όταν ολοκληρωθεί η προθέρμανση, η θερμοκρασία θα αναβοσβήσει. Ανοίξτε την πόρτα και τοποθετήστε το φαγητό στον φούρνο.



- c** Γυρίστε τον περιστροφικό διακόπτη για να ρυθμίσετε την ώρα, η μέγιστη τιμή ώρας είναι «95:00».

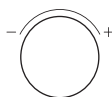

- d** Πατήστε  Start/+30Sec. για να ξεκινήσει το μαγείρεμα.



7. ΑΕΡΑΣ ΧΩΡΙΣ ΠΡΟΘΕΡΜΑΝΣΗ

- f** Πατήστε  Grill/Conv./Combi περισσότερες φορές για να επιλέξετε τη θερμοκρασία αέρα.



a ή

- f** Πατήστε  Grill/Conv./Combi μία φορά και, στη συνέχεια, γυρίστε τον περιστροφικό διακόπτη για να επιλέξετε τη θερμοκρασία αέρα. Οι διαθέσιμες επιλογές είναι 150°C, 160°C.....240°C.



- b** Πατήστε  Start/+30Sec. για να επιβεβαιώσετε τη θερμοκρασία.



- c** Γυρίστε τον περιστροφικό διακόπτη για να ρυθμίσετε την ώρα, η μέγιστη τιμή ώρας είναι «95:00».

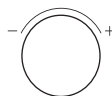



- d** Πατήστε  Start/+30Sec. για να ξεκινήσει το μαγείρεμα.

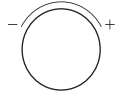

8. ΜΕΝΟΥ ΦΡΙΤΕΖΑ ΑΕΡΑ

- a** Σε κατάσταση αναμονής, γυρίστε τον περιστροφικό διακόπτη προς τα δεξιά για να εισέλθετε στη λειτουργία μενού. Γυρίστε τον περιστροφικό διακόπτη για να επιλέξετε το μενού, πληκτρολογήστε H-1.



- b** Πατήστε  για να επιβεβαιώσετε τον τύπο του μενού Start/+30Sec.



- c** Γυρίστε τον περιστροφικό διακόπτη για να επιλέξετε το δευτερεύον μενού.

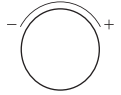

- d** Πατήστε  Start/+30Sec. για να ξεκινήσει το μαγείρεμα.



ΔΙΑΓΡΑΜΜΑ ΜΕΝΟΥ ΦΡΙΤΕΖΑ ΑΕΡΑ

ΟΘΟΝΗ	ΜΕΝΟΥ	ΒΑΡΟΣ
H-1	Κατεψυγμένες τηγανητές πατάτες	300 γρ.
H-2	Κατεψυγμένες κροκέτες πατάτας	350 γρ.
H-3	Κατεψυγμένο καλαμάρι	250 γρ.
H-4	Κατεψυγμένα onion rings	250 γρ.
H-5	Κατεψυγμένες κοτομπουκιές	350 γρ.
H-6	Εσκαλόπ	400 γρ.
H-7	Γαρίδες	250 γρ.
H-8	Λαχανικά	200 γρ.
H-9	Σπρινγκ ρολ	300 γρ.

Σημείωση: Το βάρος του μενού Φριτέζα αέρα δεν μπορεί να ρυθμιστεί.

9. ΜΕΝΟΥ ΑΥΤΟΜΑΤΟ & ΓΚΡΙΛ ΓΙΑ ΞΕΡΟΨΗΜΕΝΑ

a Σε κατάσταση αναμονής, γυρίστε τον περιστροφικό διακόπτη προς τα δεξιά για να εισέλθετε στη λειτουργία μενού. Γυρίστε τον περιστροφικό διακόπτη επανειλημμένα για να επιλέξετε το μενού Αυτόματο (ένδειξη A-1) ή το μενού Γκριλ για ξεροψημένα (ένδειξη C-1). Για παράδειγμα, επιλέξτε το C-1.

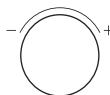



b Πατήστε  για επιβεβαίωση.

Start/+30Sec.

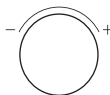

c Γυρίστε τον περιστροφικό διακόπτη για να επιλέξετε το υπομενού, C-1~C-4.



d Πατήστε  Start/+30Sec. για επιβεβαίωση. Γυρίστε τον περιστροφικό διακόπτη για να επιλέξετε το βάρος. Το βάρος των C-3 και C-4 δεν μπορεί να ρυθμιστεί.



e Πατήστε  Start/+30Sec. για επιβεβαίωση.

Start/+30Sec.



ΔΙΑΓΡΑΜΜΑ ΜΕΝΟΥ ΓΚΡΙΛ ΓΙΑ ΞΕΡΟΨΗΜΕΝΑ

ΟΘΟΝΗ	ΜΕΝΟΥ	ΒΑΡΟΣ
C-1	Κόρντον μπλου	300 γρ. 600 γρ. 900 γρ.
C-2	λαζάνια	200 γρ. 300 γρ. 400 γρ. 500 γρ.
C-3	ψωμί	100 γρ.
C-4	πίτα/τάρτα	8 (περίπου 350 γρ.)

ΔΙΑΓΡΑΜΜΑ ΜΕΝΟΥ ΑΥΤΟΜΑΤΟ

ΜΕΝΟΥ	ΟΘΟΝΗ	ΒΑΡΟΣ/ ΠΟΣΟΤΗΤΑ	ΕΠΙΠΕΔΟ ΙΣΧΥΟΣ
A-1 ΑΥΤΟΜΑΤΗ ΑΝΑΘΕΡΜΑΝΣΗ	150 γρ. 250 γρ. 350 γρ. 450 γρ. 600 γρ.	150 γρ. 250 γρ. 350 γρ. 450 γρ. 600 γρ.	P100
A-2 ΠΑΤΑΤΕΣ	1 2 3	1 (περίπου 230 γρ.) 2 3	P100
A-3 ΚΡΕΑΣ	150 γρ. 300 γρ. 450 γρ. 600 γρ.	150 γρ. 300 γρ. 450 γρ. 600 γρ.	P80
A-4 ΛΑΧΑΝΙΚΑ	150 γρ. 350 γρ. 500 γρ.	150 γρ. 350 γρ. 500 γρ.	P100
A-5 ΨΑΡΙ	150 γρ. 250 γρ. 350 γρ. 450 γρ. 650 γρ.	150 γρ. 250 γρ. 350 γρ. 450 γρ. 650 γρ.	P80
A-6 ΖΥΜΑΡΙΚΑ	50 γρ. (με κρύο νερό 450 γρ.) 100 γρ. (με κρύο νερό 800 γρ.) 150 γρ. (με κρύο νερό 1200 γρ.)	50 γρ. 100 γρ. 150 γρ.	P80
A-7 ΣΟΥΠΑ	200 γρ. 400 γρ. 600 γρ.	200 γρ. 400 γρ. 600 γρ.	P100
A-8 ΚΕΙΚ	475 γρ.	475 γρ.	ΑΕΡΑΣ 160°C (Με προθέρμανση 160°C)
A-9 ΠΙΤΣΑ	100 γρ. 200 γρ. 300 γρ.	100 γρ. 200 γρ. 300 γρ.	C-4
A10 ΚΟΤΟΠΟΥΛΟ	500 γρ. 750 γρ. 1000 γρ. 1200 γρ.	500 γρ. 750 γρ. 1000 γρ. 1200 γρ.	C-4

10. ΑΠΟΨΥΞΗ ΒΑΡΟΥΣ

- a** Πατήστε  Defrost μία φορά, θα εμφανιστεί η ένδειξη «dEF1».



- b** Γυρίστε τον περιστροφικό διακόπτη για να ρυθμίσετε το βάρος του φαγητού, στο εύρος «100 γρ.-2000 γρ.» .

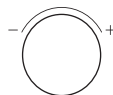

- c** Πατήστε  Start/+30Sec. για να ξεκινήσει η απόψυξη.



ΣΗΜΕΙΩΣΗ

- Ο βομβητής θα ηχήσει δύο φορές για να σας υπενθυμίσει να γυρίσετε το φαγητό κατά τη διάρκεια της απόψυξης.

11. ΧΡΟΝΟΣ ΑΠΟΨΥΞΗΣ

- a** Πατήστε  Defrost δύο φορές, θα εμφανιστεί η ένδειξη «dEF2».

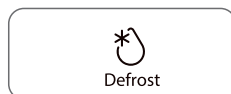

- b** Γυρίστε τον περιστροφικό διακόπτη για να ρυθμίσετε τον χρόνο, με μέγιστη τιμή χρόνου «95:00».

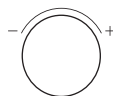

c Πατήστε  Start/+30Sec. για να ξεκινήσει η απόψυξη.

Start/+30Sec.



- Ο βομβητής θα ηχήσει για να σας υπενθυμίσει να γυρίσετε το φαγητό αφού συμπληρωθεί ο μισός χρόνος.
- Το προεπιλεγμένο επίπεδο ισχύος είναι P30 και δεν μπορεί να αλλάξει.

12. ΜΑΓΕΙΡΕΜΑ ΠΟΛΛΑΠΛΩΝ ΣΤΑΔΙΩΝ

a Πατήστε  Defrost δύο φορές, θα εμφανιστεί η ένδειξη «dEF2».

Defrost

b Γυρίστε τον περιστροφικό διακόπτη για να ρυθμίσετε την ώρα, η μέγιστη τιμή ώρας είναι «95:00».

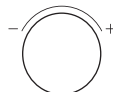

c Πατήστε  Grill/Conv./Combi για να επιλέξετε τη λειτουργία μαγειρέματος.



Grill/Conv./Combi

d Πατήστε  Start/+30Sec. για επιβεβαίωση.

Start/+30Sec.

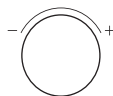
- e** Γυρίστε τον περιστροφικό διακόπτη για να ρυθμίσετε την ώρα, η μέγιστη τιμή ώρας είναι «95:00».



- f** Πατήστε  Start/+30Sec. για να ξεκινήσει το μαγείρεμα.



ΣΗΜΕΙΩΣΗ

- Μπορούν να ρυθμιστούν δύο στάδια μαγειρέματος στο μαγείρεμα πολλαπλών σταδίων.
- Εάν ορίσετε τη λειτουργία απόψυξης, θα λειτουργήσει αυτόματα στο πρώτο στάδιο.
- Το χρονόμετρο κουζίνας, το αυτόματο μενού, το γρήγορο μαγείρεμα και η προθέρμανση δεν μπορούν να οριστούν ως ένα από τα στάδια πολλαπλών φάσεων.

13. ΓΡΗΓΟΡΟ ΜΑΓΕΙΡΕΜΑ

- a** Γυρίστε τον περιστροφικό διακόπτη αριστερά μία φορά για να επιλέξετε τη λειτουργία μαγειρέματος με επίπεδο ισχύος 100% για 5 δευτερόλεπτα απευθείας.

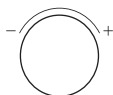

- b** Γυρίστε τον περιστροφικό διακόπτη για να ρυθμίσετε τον χρόνο, με μέγιστη τιμή χρόνου «95:00».



- c** Πατήστε  Start/+30Sec. για να ξεκινήσει το μαγείρεμα.



- a** Πατήστε  Start/+30Sec. μία φορά για να μαγειρέψετε με επίπεδο ισχύος 100% για 30 δευτερόλεπτα απευθείας.



14. ΛΕΙΤΟΥΡΓΙΑ ΚΛΕΙΔΩΜΑΤΟΣ

- a** Για να κλειδώσετε τον φούρνο μικροκυμάτων έτσι ώστε να μην μπορούν να τον χρησιμοποιήσουν παιδιά ή άλλοι μη επιθυμητοί χρήστες, πατήστε  για 3 δευτερόλεπτα. Θα εμφανιστεί το εικονίδιο κλειδώματος.



- b** Για να ξεκλειδώσετε, πατήστε  για 3 δευτερόλεπτα.



15. ΛΕΙΤΟΥΡΓΙΑ ΠΛΗΡΟΦΟΡΙΩΝ

- a** Όταν ο φούρνος μαγειρεύει, πατήστε  Timer/Clock. Ο τρέχων χρόνος θα εμφανιστεί για τρία δευτερόλεπτα στην οθόνη.



ΚΑΘΑΡΙΣΜΟΣ

Με καλή φροντίδα και καθαρισμό, η συσκευή σας θα διατηρήσει την εμφάνισή της και θα παραμείνει πλήρως λειτουργική για μεγάλο χρονικό διάστημα. Θα σας εξηγήσουμε εδώ πώς πρέπει να φροντίζετε και να καθαρίζετε σωστά τη συσκευή σας.



ΠΡΟΕΙΔΟ ΠΟΙΗΣΗ

- Το γρατζουνισμένο γυαλί στην πόρτα της συσκευής μπορεί να εξελιχθεί σε ρωγμή. Μη χρησιμοποιείτε ξύστρα γυαλιού, αιχμηρά ή λειαντικά καθαριστικά βοηθήματα ή απορρυπαντικά.
- Η επιφάνεια της συσκευής μπορεί να υποστεί ζημιά αν δεν καθαριστεί σωστά. Ενέργεια μικροκυμάτων μπορεί να διαφύγει. Καθαρίζετε τη συσκευή σε τακτική βάση και απομακρύνετε αμέσως τυχόν υπολείμματα φαγητού.
- Μη βυθίζετε τη συσκευή σε νερό ή μην καθαρίζετε κάτω από πίδακα νερού.

Καθαριστικό μέσο

Για να διασφαλίσετε ότι οι διάφορες επιφάνειες δεν θα υποστούν ζημιά από τη χρήση λανθασμένου καθαριστικού μέσου, τηρείτε τις παρακάτω πληροφορίες. Πλένετε καλά τα καινούργια πανιά σφουγγαρίσματος πριν από τη χρήση.

Μη χρησιμοποιείτε:



Σκληρά ή λειαντικά
καθαριστικά



Μεταλλικές ή γυάλινες
ξύστρες για τον καθαρισμό
των πάνελ της πόρτας



Μεταλλικές ή γυάλινες
ξύστρες για τον καθαρισμό
της στεγανοποίησης της
πόρτας



Σκληρά επιθέματα
καθαρισμού ή
σφουγγάρια



Καθαριστικά με υψηλή
περιεκτικότητα σε αλκοόλη

ΠΡΟΣΟΨΗ ΣΥΣΚΕΥΗΣ

Ζεστό σαπουνόνερο:

Καθαρίστε με ένα πανί πιάτων και στη συνέχεια στεγνώστε με ένα μαλακό πανί. Μη χρησιμοποιείτε μεταλλικές ή γυάλινες ξύστρες για τον καθαρισμό.

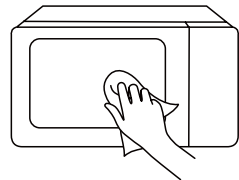

ΚΑΘΑΡΙΣΜΟΣ

ΜΠΡΟΣΤΙΝΗ ΠΛΑΚΑ ΤΗΣ ΣΥΣΚΕΥΗΣ

Ζεστό σαπουνόνερο:

Καθαρίστε με ένα πανί πιάτων και στη συνέχεια στεγνώστε με ένα μαλακό πανί.

Απομακρύνετε αμέσως τις πιτσιλιές και τις κηλίδες από άλατα, λίπη, άμυλο και λευκώματα. Κάτω από αυτούς τους λεκέδες ή τις πιτσιλιές μπορεί να σχηματιστεί διάβρωση. Μη χρησιμοποιείτε καθαριστικά γυαλιού ή μεταλλικές ή γυάλινες ξύστρες για τον καθαρισμό.

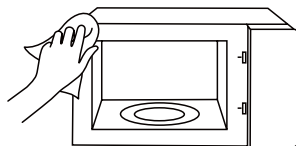

ΕΣΩΤΕΡΙΚΟ ΤΜΗΜΑ

Ζεστό σαπουνόνερο ή διάλυμα ξιδιού:

Καθαρίστε με ένα πανί πιάτων και στη συνέχεια στεγνώστε με ένα μαλακό πανί. Μη χρησιμοποιείτε σπρέι φούρνου ή άλλα επιθετικά καθαριστικά φούρνου ή λειαντικά υλικά. Ακατάλληλα είναι επίσης τα σφουγγάρια καθαρισμού, τα τραχιά σφουγγάρια και τα καθαριστικά ταψιών. Αυτά τα αντικείμενα χαράζουν την επιφάνεια. Αφήστε τις εσωτερικές επιφάνειες να στεγνώσουν εντελώς.

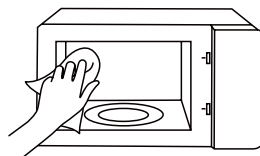

ΕΣΟΧΕΣ ΣΤΟ ΕΣΩΤΕΡΙΚΟ ΤΜΗΜΑ

Υγρό πανί:

Το νερό δεν πρέπει να εισέρχεται στη συσκευή μέσω του περιστρεφόμενου δίσκου. Στεγνώστε τον περιστρεφόμενο δίσκο με ένα πανί.

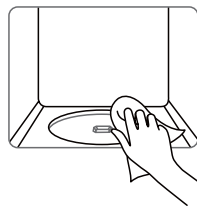

ΠΕΡΙΣΤΡΕΦΟΜΕΝΟΣ ΔΙΣΚΟΣ ΚΑΙ ΔΑΚΤΥΛΙΟΣ ΚΥΛΙΝΔΡΟΥ

Ζεστό σαπουνόνερο:

Όταν τοποθετείτε τον περιστρεφόμενο δίσκο πίσω στην εσοχή του, πρέπει να ασφαλίσει σωστά.

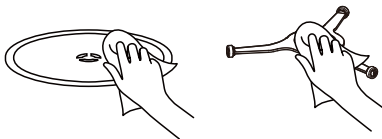

ΠΙΝΑΚΑΣ ΠΟΡΤΑΣ

Καθαριστικό γυαλιού:

Καθαρίστε με ένα πανί πιάτων. Μη χρησιμοποιείτε ξύστρες γυαλιού.

ΣΥΝΤΗΡΗΣΗ

ΑΝΤΙΜΕΤΩΠΙΣΗ ΠΡΟΒΛΗΜΑΤΩΝ

Δοκιμάστε τις λύσεις για κάθε πρόβλημα αφού χρησιμοποιήσετε τον παρακάτω πίνακα για να ελέγξετε το πρόβλημά σας. Επικοινωνήστε με την πλησιέστερη εξουσιοδοτημένη υπηρεσία σέρβις εάν ο φούρνος μικροκυμάτων εξακολουθεί να μην λειτουργεί σωστά.

ΠΡΟΒΛΗΜΑ	ΠΙΘΑΝΗ ΑΙΤΙΑ	ΠΙΘΑΝΗ ΛΥΣΗ
Ο φούρνος δεν ξεκινάει	<ul style="list-style-type: none">α. Το ηλεκτρικό καλώδιο του φούρνου δεν είναι συνδεδεμένο στην πρίζα.β. Η πόρτα είναι ανοιχτή.γ. Έχει επιλεγεί η λανθασμένη λειτουργία.	<ul style="list-style-type: none">α. Συνδέστε το στην πρίζα.β. Κλειδώστε την πόρτα και δοκιμάστε άλλη μια φορά.γ. Επαληθεύστε τις οδηγίες
Δημιουργία τόξου ή σπινθήρα	<ul style="list-style-type: none">α. Χρησιμοποιήθηκαν αντικείμενα που δεν πρέπει να χρησιμοποιούνται σε φούρνο μικροκυμάτων.β. Ο φούρνος χρησιμοποιείται όταν είναι άδειος.γ. Τρόφιμα που έχουν χυθεί παραμένουν στην κοιλότητα.	<ul style="list-style-type: none">α. Χρησιμοποιείτε μόνο μαγειρικά σκεύη που είναι ασφαλή για φούρνο μικροκυμάτων.β. Ποτέ μη χρησιμοποιείτε φούρνο που είναι άδειος.γ. Τρίψτε την κοιλότητα με μια υγρή πετσέτα.
Ανομοιόμορφα μαγειρεμένα τρόφιμα	<ul style="list-style-type: none">α. Χρησιμοποιήθηκαν αντικείμενα που δεν πρέπει να χρησιμοποιούνται σε φούρνο μικροκυμάτων.β. Το φαγητό δεν έχει αποψυχθεί πλήρως.γ. Το επίπεδο ισχύος είναι ανεπαρκές για το χρόνο μαγειρέματος.δ. Το φαγητό δεν έχει περιστραφεί ή αναδευτεί.	<ul style="list-style-type: none">α. Χρησιμοποιείτε μόνο μαγειρικά σκεύη ασφαλή για φούρνο μικροκυμάτωνβ. Αποψύξτε πλήρως τα τρόφιμα.γ. Χρησιμοποιήστε την κατάλληλη ισχύ και τον κατάλληλο χρόνο μαγειρέματος.δ. Ανακατέψτε ή γυρίστε το φαγητό.
Υπερψημένα τρόφιμα	Ο χρόνος μαγειρέματος και το επίπεδο ισχύος είναι ανεπαρκή.	Χρησιμοποιήστε την κατάλληλη ισχύ και τον κατάλληλο χρόνο μαγειρέματος.
Μη καλά μαγειρεμένα τρόφιμα	<ul style="list-style-type: none">α. Χρησιμοποιήθηκαν αντικείμενα που δεν πρέπει να χρησιμοποιούνται σε φούρνο μικροκυμάτων.β. Το φαγητό δεν έχει αποψυχθεί πλήρως.γ. Οι θύρες εξαερισμού του φούρνου είναι περιορισμένες.δ. Ο χρόνος μαγειρέματος και το επίπεδο ισχύος είναι ακατάλληλα.	<ul style="list-style-type: none">α. Χρησιμοποιείτε μόνο μαγειρικά σκεύη που είναι ασφαλή για φούρνο μικροκυμάτων.β. Ξεπαγώστε πλήρως το φαγητό.γ. Βεβαιωθείτε ότι οι θύρες εξαερισμού του φούρνου δεν είναι φραγμένες.δ. Χρησιμοποιήστε τον κατάλληλο χρόνο μαγειρέματος και το κατάλληλο επίπεδο ισχύος.
Ακατάλληλη απόψυξη	<ul style="list-style-type: none">α. Χρησιμοποιήθηκαν αντικείμενα που δεν πρέπει να χρησιμοποιούνται σε φούρνο μικροκυμάτων.β. Ακατάλληλο επίπεδο ισχύος και χρόνος μαγειρέματος.γ. Δεν έγινε περιστροφή ή τρίψιμο των τροφίμων.	<ul style="list-style-type: none">α. Χρησιμοποιείτε μόνο μαγειρικά σκεύη ασφαλή για μικροκύματα.β. Χρησιμοποιήστε τον συνιστώμενο χρόνο μαγειρέματος και το συνιστώμενο επίπεδο ισχύος.γ. Αναποδογυρίστε ή γυρίστε το φαγητό.



Σύμφωνα με την οδηγία για τα απόβλητα από ηλεκτρικό και ηλεκτρονικό εξοπλισμό (ΑΗΗΕ), τα ΑΗΗΕ θα πρέπει να συλλέγονται και να απορρίπτονται ξεχωριστά. Εάν χρειαστεί να απορρίψετε αυτό το προϊόν στο μέλλον, παρακαλούμε να μην το απορρίψετε μαζί με τα οικιακά σας απορρίμματα. Παρακαλείστε να μεταφέρετε αυτό το προϊόν σε σημείο συλλογής ΑΗΗΕ, όπου υπάρχει.

#DetailsMatter

MANUAL DE INSTRUÇÕES

FORNO MICRO-ONDAS

MW3-AC26SF(WH)

Consulte este manual de instruções antes da utilização.

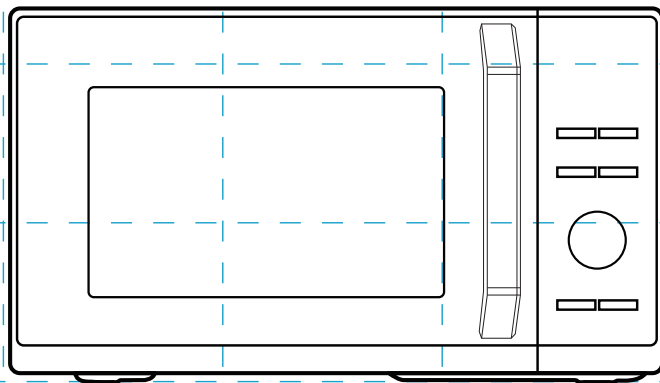

TOSHIBA

ÍNDICE

SEGURANÇA DO PRODUTO

Precauções para evitar possível exposição a níveis excessivos de energia de micro-ondas	PT-01
Instruções importantes de segurança	PT-03
Instalação da ligação à terra	PT-08
Limpeza	PT-10
Utensílios	PT-11
Materiais que pode utilizar no forno de micro-ondas	PT-12
Os materiais não podem ser utilizados em fornos de micro-ondas	PT-14

CONFIGURAÇÃO DO PRODUTO

Configuração do seu forno	PT-15
---------------------------------	-------

INSTRUÇÕES DE UTILIZAÇÃO

Antes de utilizar pela primeira vez	PT-18
Operação	PT-19
1. Níveis de potência	PT-20
2. Acerto do relógio	PT-20
3. Temporizador de cozinha	PT-21
4. Cozinhar com micro-ondas	PT-22
5. Grelhador ou combinado	PT-22
6. Convecção com pré-aquecimento	PT-23
7. Convecção sem pré-aquecimento	PT-24
8. Menu Airfry	PT-25
9. Menu automático e menu de grelhados crocantes	PT-26
10. Peso de descongelação	PT-28
11. Tempo de descongelação	PT-28
12. Cozedura em várias fases	PT-29

13. Cozedura rápida	PT-30
14. Função de bloqueio	PT-31
15. Função de consulta	PT-31

LIMPEZA E MANUTENÇÃO

Limpeza	PT-32
Resolução de problemas	PT-34



NOTA

ANTES DE OPERAR ESTE PRODUTO, LEIA, COMPREENDA, E SIGA ESTAS INSTRUÇÕES. NÃO SE ESQUEÇA DE GUARDAR ESTA LISTA DE LIVROS PARA CONSULTA FUTURA.

SEGURANÇA DO PRODUTO

PRECAUÇÕES PARA EVITAR POSSÍVEL EXPOSIÇÃO A NÍVEIS EXCESSIVOS MICRO-ONDAS

- (a). Não tente utilizar este forno com a porta aberta, pois tal pode resultar numa exposição nociva a energia micro-ondas. É importante não quebrar ou adulterar os interbloqueios de segurança.
- (b). Não coloque quaisquer objetos entre a superfície dianteira do forno e a porta, nem permita a acumulação de sujidade ou de resíduos de detergente nas superfícies isolantes.
- (c). **AVISO:** Se a porta ou as vedações da porta estiverem danificadas, o forno não deverá ser utilizado até que seja reparado por uma pessoa competente.

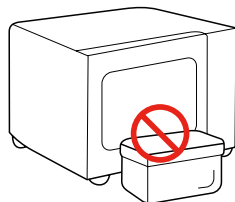

ADENDA

Se o eletrodoméstico não for mantido num bom estado de limpeza, a sua superfície pode ficar degradada, afetando a vida útil do mesmo e dando origem a uma situação perigosa.

ESPECIFICAÇÕES

MODELO	MW3-AC26SF(WH)
TENSÃO/FREQUÊNCIA NOMINAL	230-240 V~ 50 Hz
POTÊNCIA DE ENTRADA NOMINAL (MICRO-ONDAS)	1450 W
POTÊNCIA DE SAÍDA NOMINAL (MICRO-ONDAS)	900 W
POTÊNCIA DE ENTRADA NOMINAL (GRELHADOR)	1000 W
POTÊNCIA DE ENTRADA NOMINAL (CONVECÇÃO)	2100 W



NOTA

Todas as imagens neste manual servem apenas para fins ilustrativos; podem ser ligeiramente diferentes do equipamento adquirido, consulte o produto real.

INSTRUÇÕES IMPORTANTES DE SEGURANÇA



AVISO

A fim de reduzir o risco de incêndio, choque elétrico, ferimentos ou exposição a níveis excessivos de energia do forno micro-ondas durante a utilização do seu eletrodoméstico, siga as precauções básicas, incluindo as seguintes:



Leia e siga o especificado: **"PRECAUÇÕES PARA EVITAR POSSÍVEL EXPOSIÇÃO A NÍVEIS EXCESSIVOS DE ENERGIA DO MICRO-ONDAS"**.



Este equipamento pode ser usado por crianças a partir de 8 anos e mais e por pessoas com capacidades físicas, sensoriais ou mentais reduzidas ou com falta de experiência e conhecimento se lhes tiver sido dada a supervisão ou instrução relativamente ao uso do equipamento de uma forma segura e entender os riscos envolvidos. As crianças não devem brincar com o aparelho.



A manutenção não deve ser realizada por crianças sem supervisão.



Mantenha o eletrodoméstico e o seu cabo de alimentação fora do alcance das crianças com menos de 8 anos.





Se o cabo de alimentação estiver danificado, deve ser substituído pelo fabricante ou respetivo agente de assistência ou uma pessoa similarmente qualificada para evitar riscos.



AVISO: Assegure-se de que o aparelho está desligado antes de substituir a lâmpada para evitar a possibilidade de choque elétrico.

INSTRUÇÕES IMPORTANTES DE SEGURANÇA

 **AVISO:** É perigoso para uma pessoa, que não um técnico qualificado, proceder a qualquer operação de assistência ou reparação, que envolva a remoção de uma tampa de proteção contra a exposição à energia de micro-ondas.

 **AVISO:** Os líquidos ou outros alimentos não devem ser aquecidos em recipientes selados, uma vez que podem explodir.

 Ao aquecer alimentos em recipientes plásticos ou de papel, vigie o forno devido à possibilidade de ignição.



 Apenas utilize utensílios que sejam adequados à utilização em fornos micro-ondas.

 Se for emitido fumo, desligue o aparelho ou retire a ficha da tomada e mantenha a porta fechada, de forma a abafar quaisquer chamas.

 O aquecimento de bebidas no micro-ondas pode resultar no sobreaquecimento do líquido para além do ponto de ebulição sem que se verifique o borbulhar, portanto, deverá ter cuidado no manuseio do recipiente.

 O conteúdo de biberões e de recipientes de comida para bebé devem ser mexidos ou agitados e a temperatura deve ser verificada antes do consumo de forma a evitar queimaduras.

INSTRUÇÕES IMPORTANTES DE SEGURANÇA

 O forno deve ser limpo regularmente e quaisquer resíduos de alimentos devem ser removidos. Mantenha a área do guia de ondas limpa. Utilize um pano macio e húmido para o limpar quando houver resíduos de comida na área do guia de ondas ou na cavidade. A falta de limpeza dos resíduos alimentares pode provocar faíscas inócuas ou algum fumo na cavidade do micro-ondas, podendo também ocorrer descoloração da cavidade.

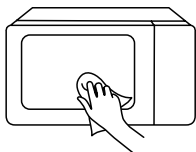

 A falta de limpeza do forno poderá levar à deterioração da superfície, o que poderá afetar o tempo de vida útil do aparelho e, possivelmente, resultar numa situação perigosa.

 Utilize apenas a sonda de temperatura recomendada para este forno. (para fornos equipados com a possibilidade de utilizar uma sonda de temperatura.)

 O forno micro-ondas tem de ser utilizado com a porta decorativa aberta. (para fornos com porta decorativa.)

 Este aparelho destina-se a ser utilizado em aplicações domésticas e similares, tais como:

1. áreas de cozinha dos funcionários em lojas, escritórios e outros ambientes de trabalho;
2. por clientes em hotéis, motéis e outros ambientes de residências;
- 3 casas rurais;
- 4 ambientes do tipo alojamento e pequeno-almoço.

INSTRUÇÕES IMPORTANTES DE SEGURANÇA

 O forno micro-ondas destina-se ao aquecimento de alimentos e bebidas. A secagem de alimentos ou roupa e o aquecimento de almofadas de aquecimento, chinelos, esponjas, panos molhados ou objetos semelhantes pode causar o risco de ferimentos, ignição ou fogo.

 Este eletrodoméstico destina-se a ser utilizado de forma independente.

 A superfície traseira dos eletrodomésticos deve ser colocada contra uma parede.

 A temperatura das superfícies acessíveis pode ser elevada quando o aparelho está a funcionar.

 **AVISO:** quando o eletrodoméstico é utilizado no modo combinado, as

crianças apenas podem utilizar o forno sob supervisão de adultos devido às temperaturas geradas.

 Não deve utilizar fornos micro-ondas para aquecer ovos com casca nem ovos cozidos, uma vez que estes podem explodir depois de aquecidos no micro-ondas.

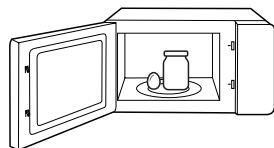



 O aparelho não deve ser instalado atrás da porta de um móvel de cozinha, de forma a evitar o sobreaquecimento. (esta instrução não é aplicável a eletrodomésticos com porta decorativa.)

INSTRUÇÕES IMPORTANTES DE SEGURANÇA

 O forno micro-ondas não deve ser colocado num armário, exceto se tiver sido testado num.

 Recipientes metálicos para alimentos e bebidas não são permitidos durante a cozedura no micro-ondas.

 O eletrodoméstico não deve ser limpo com um aparelho de limpeza a vapor.

 Os aparelhos não se destinam a ser operados através de um temporizador externo ou de um sistema de controlo remoto separado.

LEIA CUIDADOSAMENTE E
CONSERVE PARA REFERÊNCIA
FUTURA

PARA REDUZIR O RISCO DE FERIMENTOS EM PESSOAS, INSTALAÇÃO DE LIGAÇÃO À TERRA

Este aparelho deve ter ligação à terra. No caso de curto-circuito elétrico, a ligação à terra reduz o risco de choque elétrico através de um fio de descarga para a corrente elétrica.

Este aparelho está equipado com um cabo com ficha de ligação à terra. A ficha deve ser ligada a uma tomada corretamente instalada e com ligação à terra.

AVISO - O uso inadequado da ligação à terra pode resultar em risco de choque elétrico. Contacte um electricista ou técnico qualificado se não compreender em absoluto as indicações sobre a ligação à terra ou em caso de dúvida sobre a correta ligação à terra do aparelho.

Caso seja necessário utilizar uma extensão, utilize apenas um cabo de extensão com 3 conectores.



PERIGO

Perigo de choque elétrico:

Tocar em alguns dos componentes internos pode resultar em graves danos pessoais ou morte. Não desmonte este aparelho.

PARA REDUZIR O RISCO DE FERIMENTOS EM PESSOAS, INSTALAÇÃO DE LIGAÇÃO À TERRA



AVISO

Perigo de choque elétrico:

A utilização inadequada do sistema de ligação à terra pode originar choques elétricos. Não ligue o aparelho a uma tomada até que esteja devidamente instalado e ligado à terra.

1. O micro-ondas inclui um cabo de alimentação curto, para reduzir os riscos de o utilizador ficar preso ou tropeçar num cabo mais comprido.
2. Se for usado um cabo longo ou extensão:
 - (1). A classificação elétrica do cabo ou extensão deve ser minimamente aproximada à classificação elétrica do aparelho.
 - (2). O cabo de extensão deve ser de ligação à terra com 3 conectores.
 - (3). O cabo comprido deve ser disposto de forma que não fique pendurado sobre o balcão ou sobre a mesa, onde possa ser puxado por crianças ou no qual possa tropeçar inadvertidamente.

LIMPEZA

Desligue o aparelho da fonte de alimentação.

1. Após a utilização, limpe o compartimento do forno com um pano ligeiramente humedecido.
2. Limpe os acessórios com água com sabão pela via normal.
3. A moldura e o vedante da porta e os componentes adjacentes devem ser cuidadosamente limpos com um pano húmido quando estiverem sujos.
4. Não utilize produtos de limpeza abrasivos ou raspadores de metal afiados para limpar o vidro da porta do forno, já que podem arranhar a superfície e partir o vidro.
5. Sugestão de limpeza---Para uma limpeza facilitada das paredes do compartimento com as quais os alimentos podem entrar em contacto: Coloque meio limão numa taça, adicione 300 ml de água e aqueça à potência máxima do micro-ondas durante 10 minutos. Limpe o forno com um pano macio e seco.

UTENSÍLIOS



CUIDADO

Perigo de ferimentos pessoais:

É perigoso para qualquer pessoa que não seja um técnico competente realizar qualquer operação de manutenção ou reparação que envolva a remoção de uma cobertura que proteja contra a exposição à energia de micro-ondas. Consulte as instruções nas secções "**Materiais que pode utilizar no forno micro-ondas**" ou "**Materiais que não pode utilizar no forno micro-ondas**".

Pode não ser segura a utilização de determinados utensílios não metálicos no micro-ondas. Em caso de dúvida, pode testar o utensílio em questão seguindo o procedimento abaixo.

Teste de utensílio:

1. Encha um recipiente adequado para micro-ondas com 1 copo de água fria (250 ml) juntamente com o utensílio em questão.
2. Cozinhe na potência máxima durante 1 min.
3. Verifique cuidadosamente a temperatura do utensílio. Se o utensílio vazio estiver quente, não o utilize para cozinhar no micro-ondas.
4. Não exceda 1 minuto de tempo de cozimento.

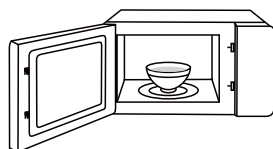

NOTA



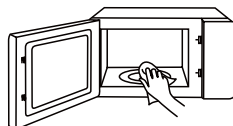





MANTENHA O COMPARTIMENTO DE COZIMENTO E A ÁREA DO GUIA DE ONDAS LIMPAS













MATERIAIS QUE PODE UTILIZAR NO FORNO MICRO-ONDAS

UTENSÍLIOS	OBSERVAÇÕES	
 Prato para altas temperaturas	Siga as instruções do fabricante. A parte inferior do prato para altas temperaturas deve estar, pelo menos, 5 mm acima do prato giratório. O prato giratório pode partir se o utilizar incorretamente.	
 Loiça	Apenas adequada para o micro-ondas. Siga as instruções do fabricante. Não utilize pratos rachados ou lascados.	
 Frascos de vidro	Retire sempre a tampa. Utilize apenas para aquecer alimentos até que fiquem quentes. A maioria dos frascos de vidro não são resistentes ao calor e podem partir.	
 Objetos de vidro	Apenas objetos de vidro resistentes ao calor do forno. Certifique-se de que não possuem acabamentos metálicos. Não utilize pratos rachados ou lascados.	
 Sacos para micro-ondas	Siga as instruções do fabricante. Não feche com arame de metal. Faça cortes para permitir a saída de vapor.	
 Copos e pratos de papel	Utilize apenas para cozinhar/aquecer a curto prazo. Não deixe o aparelho sem vigilância durante a cozedura.	
 Papel de cozinha	Utilize para cobrir alimentos, de forma a reaquecê-los e absorver a gordura. Utilize apenas para períodos curtos de cozedura sob vigilância.	
 Papel vegetal	Utilize para cobrir, de forma a evitar salpicos, ou envolver os alimentos durante a cozedura a vapor.	

MATERIAIS QUE PODE UTILIZAR NO FORNO MICRO-ONDAS

UTENSÍLIOS	OBSERVAÇÕES
 <p data-bbox="170 480 248 501">Plástico</p>	<p data-bbox="350 352 910 549">Apenas adequada para o micro-ondas. Siga as instruções do fabricante. Deve ser rotulado como "Seguro para micro-ondas". Alguns recipientes de plástico podem amolecer à medida que os alimentos no seu interior são aquecidos. "Os sacos para micro-ondas" e sacos hermeticamente fechados devem ser perfurados, conforme indicado na embalagem.</p> 
 <p data-bbox="123 691 295 711">Película aderente</p>	<p data-bbox="350 595 852 703">Apenas adequada para o micro-ondas. Utilize para cobrir alimentos durante a cozedura, de forma a protegê-los da desidratação. Não deixe que a película aderente toque nos alimentos.</p> 
 <p data-bbox="140 855 277 876">Termómetros</p>	<p data-bbox="350 791 874 842">Apenas adequada para o micro-ondas (termómetros para carne e doces).</p> 
 <p data-bbox="132 1018 288 1038">Papel encerado</p>	<p data-bbox="350 954 809 1005">Utilize para cobrir alimentos, de forma a evitar salpicos e protegê-los da desidratação.</p> 

MATERIAIS QUE NÃO PODE UTILIZAR NO FORNO MICRO-ONDAS

UTENSÍLIOS	OBSERVAÇÕES	
 Recipientes de alumínio	Podem originar a formação de arco elétrico. Transfira os alimentos para um prato de utilização segura no micro-ondas.	
 Embalagens com pega de metal	Podem originar a formação de arco elétrico. Transfira os alimentos para um prato de utilização segura no micro-ondas.	
 Utensílios de metal ou com acabamentos metálicos.	O metal protege os alimentos da energia de micro-ondas. Os acabamentos metálicos podem originar a formação de arco elétrico.	
 Arames de metal	Pode causar arco elétrico e incêndio no forno.	
 Sacos de papel	Pode causar incêndio no forno.	
 Espuma plástica	A espuma plástica pode derreter ou contaminar o líquido no seu interior quando exposta a temperaturas elevadas.	
 Madeira	Quando utilizada no forno micro-ondas, a madeira irá secar e poderá lascrar ou rachar.	

CONFIGURAÇÃO DO PRODUTO

CONFIGURAÇÃO DO SEU FORNO

Em caso de diferenças entre o eletrodoméstico e as imagens apresentadas neste manual, prevalecerá o produto.

DESIGNAÇÃO DAS PEÇAS E ACESSÓRIOS DO FORNO MICRO-ONDAS

Retire o forno e todos os materiais do interior da caixa e do interior do forno.

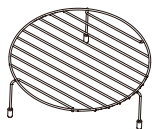

Suporte superior para grelhador

Grelha (não pode ser utilizada na função micro-ondas e deve ser colocada sobre o tabuleiro de vidro)

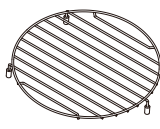

Suporte inferior para grelhador

Grelha (não pode ser utilizada na função micro-ondas e deve ser colocada sobre o tabuleiro de vidro)

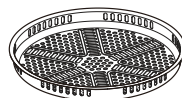

Tabuleiro de cozedura (não pode ser utilizado com a função de micro-ondas e pode ser colocado no grelhador)



Prato de vidro

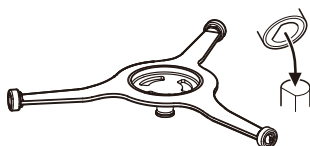

Montagem do Anel do Prato Giratório



Manual de instruções

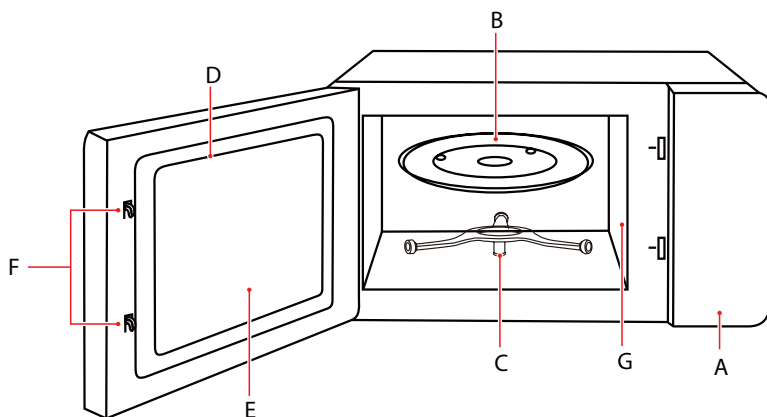

A) Painel de controlo
B) Prato de vidro
C) Anel do prato giratório
D) Conjunto da porta

E) Janela de observação
F) Sistema de interbloqueio de segurança
G) Tampa do guia de ondas

CONFIGURAÇÃO DO SEU FORNO

INSTAÇÃO DO PRATO GIRATÓRIO

Limpe o compartimento de cozedura e coloque o prato giratório na posição correta. Para novas instalações, certifique-se de que todas as embalagens e fitas de transporte foram removidas do eixo do prato giratório.

Antes de utilizar o aparelho para preparar alimentos pela primeira vez, terá de colocar corretamente o prato giratório. É necessário limpar o compartimento de cozedura e os acessórios. Também pode obter mais informações na secção de limpeza.

Como colocar o prato giratório no lugar:

1. Coloque a montagem do anel giratório ② no recesso do compartimento de cozedura.
2. Coloque a bandeja de vidro ① na montagem do anel de prato giratório ②.

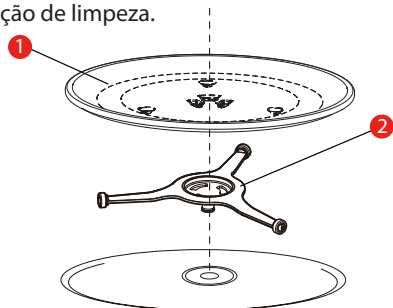

1) Prato de vidro

2) Montagem do anel do prato giratório

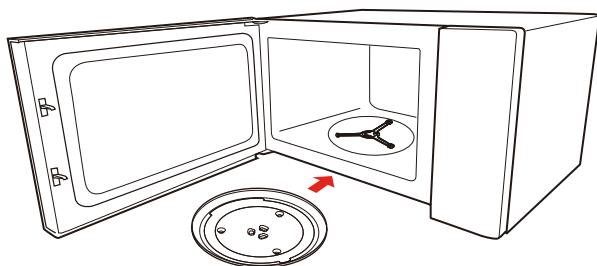

NOTA

- Nunca utilizar o aparelho sem o prato giratório. Certificar-se de que está devidamente engatado. O prato giratório pode girar no sentido dos ponteiros do relógio ou no sentido contrário.
- Nunca coloque o prato de vidro ao contrário. O prato de vidro nunca deve ficar bloqueado.
- Tanto o prato de vidro como o anel do prato giratório devem ser sempre utilizados durante a cozedura.
- Todos os alimentos e recipientes de alimentos devem ser sempre colocados no prato de vidro para a respetiva cozedura.
- Nunca restrinja o movimento do prato giratório.
- Se o prato de vidro ou o anel do prato giratório se partir ou rachar, contacte o seu centro de assistência autorizado mais próximo.

INSTALAÇÃO EM BALCÃO

Retire todo o material de embalagem e acessórios. Examine o forno e veja se tem danos como moissas ou a porta partida. Não instale o forno se estiver danificado.

Armário: remova toda a película protetora que se encontra na superfície do forno micro-ondas. Não remova a cobertura de guia de ondas que se encontra no interior do forno (para proteção do magnetrão).

INSTALAÇÃO

1. Selecione uma superfície nivelada com espaço livre suficiente para as entradas e/ou saídas de ar.
 - a. A altura mínima da instalação é de 85 cm.
 - b. A superfície traseira do aparelho deve ser colocada contra uma parede, deixando uma folga mínima de 30 cm acima do forno. É necessário um espaço mínimo de 20 cm entre o forno e as paredes adjacentes.
 - c. Não remova os pés da parte inferior do forno.
 - d. O bloqueio das aberturas de entrada e/ou saída de ar pode danificar o forno.
 - e. Coloque o forno o mais afastado possível de rádios e aparelhos de TV. O funcionamento do forno micro-ondas pode causar interferência na recepção do seu rádio ou TV.

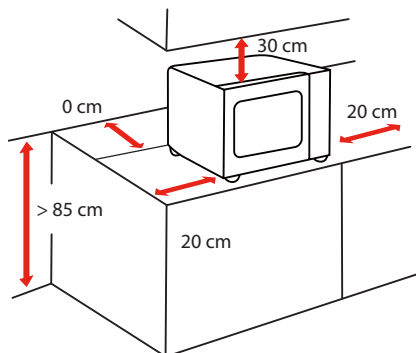

2. Ligue o forno micro-ondas a uma tomada elétrica doméstica normal. Certifique-se de que a tensão e a frequência é a mesma que a tensão e frequência indicados na etiqueta de classificação.



NOTA

- Não instale o forno por cima de uma placa elétrica ou outro eletrodoméstico que produza calor. Se instalado junto ou por cima de uma fonte de calor, o forno pode sofrer danos e a garantia poderá ficar sem efeito.

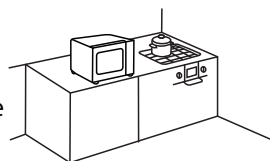

A superfície acessível pode ficar quente durante o funcionamento

INSTRUÇÕES DE UTILIZAÇÃO

ANTES DE UTILIZAR PELA PRIMEIRA VEZ

É normal que o forno possa produzir odores desagradáveis quando é utilizado pela primeira vez.

Esta secção indica-lhe o que deve fazer antes de utilizar o micro-ondas para preparar alimentos pela primeira vez. Leia previamente a secção intitulada “**SEGURANÇA DO PRODUTO**”.

Antes de poder utilizar o seu aparelho novo, é necessário colocar corretamente o prato giratório na respetiva posição. Também é necessário limpar o compartimento de cozedura e os acessórios.



NOTA

- Nunca utilizar o aparelho sem o prato giratório.
- Certifique-se de que está corretamente encaixado. O prato giratório pode rodar para a direita ou para a esquerda.

OPERAÇÃO

PAINEL DE CONTROLO E FUNCIONALIDADES

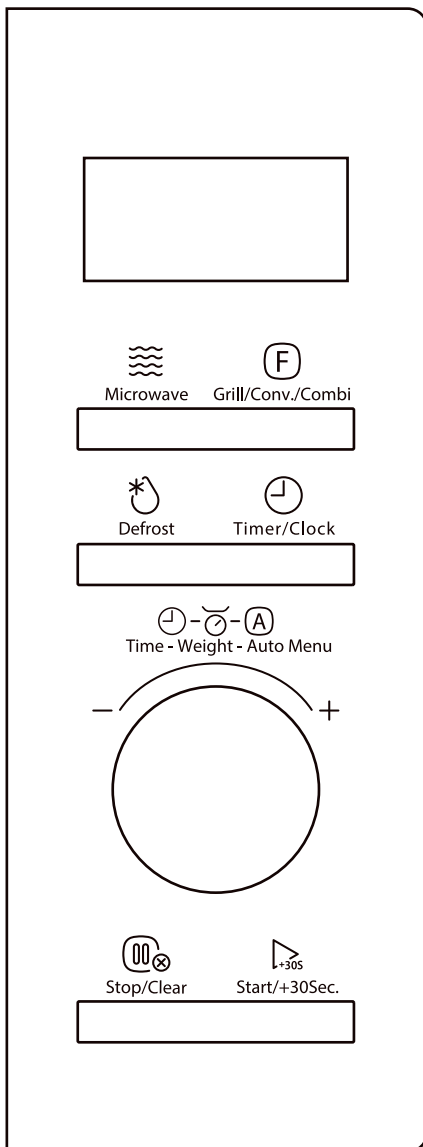







1. NÍVEIS DE POTÊNCIA

Estão disponíveis cinco níveis de potência.

NÍVEL	POTÊNCIA	VISOR
1	100%	P100
2	80%	P80
3	50%	P50
4	30%	P30
5	10%	P10

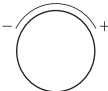
2. ACERTO DO RELÓGIO

Quando o forno micro-ondas está ligado a uma tomada, aparece "0:00".

- a**  Prima **Timer/Clock** duas vezes, é apresentado 00:00. 
- b** Rode o botão para definir o número de horas, que deve estar entre 0-23. 
- c**  Prima **Start/+30Sec.** ou  **Timer/Clock** para confirmar os valores das horas. 
- d** Rode o botão para definir os números dos minutos, que devem estar entre 0-59. 

e Prima  Start/+30Sec. ou  Timer/Clock para confirmar.



NOTA

- Quando o forno é ligado, se o relógio não estiver acertado, não funciona.
- No processo de acerto do relógio, se não houver nenhuma operação em 5 minutos ou se premir  diretamente, o visor regressa automaticamente à definição anterior do relógio.

3. TEMPORIZADOR DE COZINHA

Quando o forno micro-ondas está ligado a uma tomada, aparece "0:00".

a Prima  Timer/Clock uma vez



b Rode o botão para definir o tempo, que deve estar entre 0:05-95:00.



c Prima  Start/+30Sec. para iniciar a contagem decrescente











NOTA



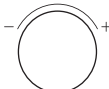

- A definição do Temporizador de cozinha é diferente da definição do Relógio; é simplesmente um temporizador.
- Durante o funcionamento do temporizador de cozinha, não é possível ativar qualquer função de cozedura.

4. COZINHAR COM MICRO-ONDAS

Quando o forno micro-ondas está ligado a uma tomada, aparece "0:00".

- a** ou
- Prima  mais vezes para escolher o nível de potência.
- Prima  uma vez e, em seguida, rode o botão para definir o nível de potência
- b** Prima  para confirmar o nível de potência.
- c** Rode o botão para definir a hora, o valor máximo de tempo é "95:00".
- d** Prima  para começar a cozinhar.
- 
- 
- 
- 
- 

5. GRELHADOR OU COMBINADO

- a** ou
- Prima  mais vezes para escolher o modo.
- Prima  uma vez e, em seguida, rode o botão para escolher o modo.
- "G-1, C-1...C-4, 150 °C, 160 °C.....240 °C" serão apresentados por ordem. ("G-1" é grelhador, "C-1~C-4" são combinados).
- 
- 

b Prima  Start/+30Sec. para confirmar o modo.



c Rode o botão para definir a hora, o valor máximo de tempo é "95:00".

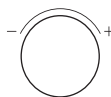

d Prima  Start/+30Sec. para começar a cozinhar.



NOTA

• Quando metade do tempo tiver terminado, o sinal sonoro soa para o lembrar de virar os alimentos durante a função de grelhar. Se não realizar qualquer operação, o forno continuará a trabalhar.

6. CONVECÇÃO COM PRÉ-AQUECIMENTO

a Prima  Grill/Conv./Combi mais vezes para escolher a temperatura de convecção.



a ou

a Prima  Grill/Conv./Combi uma vez e, em seguida, rode o botão para escolher a temperatura de convecção. 150 °C, 160 °C.....240 °C estão disponíveis.



b Prima  Start/+30Sec. duas vezes para iniciar o pré-aquecimento. Quando o pré-aquecimento estiver concluído, a temperatura pisca, abra a porta e coloque os alimentos no forno.



c Rode o botão para definir a hora, o valor máximo de tempo é "95:00".

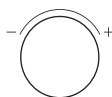

d Prima  para começar a cozinhar.



7. CONVECÇÃO SEM PRÉ-AQUECIMENTO

a Prima  mais vezes para escolher a temperatura de convecção.



a ou

b Prima  uma vez e, em seguida, rode o botão para escolher a temperatura de convecção. 150 °C, 160 °C.....240 °C estão disponíveis.



b Prima  para confirmar a temperatura.



c Rode o botão para definir a hora, o valor máximo de tempo é "95:00".

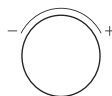

d Prima  para começar a cozinhar.



8. MENU AIRFRY

a No estado de espera, rode o botão para a direita para aceder à função de menu.

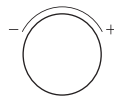

Rode o botão repetidamente para escolher o tipo de menu H-1.

b Prima  Start/+30Sec. para confirmar o tipo de menu



c Rode o botão para escolher o submenu.

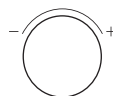

d Prima  Start/+30Sec. para começar a cozinhar.



GRÁFICO DE MENU AIRFRY

VISOR	MENU	PESO
H-1	Batatas fritas congeladas	300 g
H-2	Croquetes de batata congelados	350 g
H-3	Lulas congeladas	250 g
H-4	Anéis de cebola congelados	250 g
H-5	Nuggets de frango congelados	350 g
H-6	Escalope	400 g
H-7	Camarão	250 g
H-8	Vegetais	200 g
H-9	Rolinhos primavera	300 g

Nota: Não é possível definir o peso do menu airfry.

9. MENU AUTOMÁTICO E MENU DE GRELHADOS CROCANTES

- a** No estado de espera, rode o botão para a direita para aceder à função de menu. Rode o botão repetidamente para escolher o menu automático (visor A-1) ou o menu de grelhado crocante (visor C-1). Por exemplo, escolha o C-1.

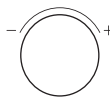

- b** Prima  Start/+30Sec. para confirmar.



- c** Rode o botão para escolher o submenu, C-1~C-4 estão disponíveis.

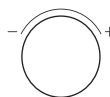

- d** Prima  Start/+30Sec. para confirmar. Rode o botão para escolher o peso do alimento. Não é possível definir o peso de C-3 e C-4.



- e** Prima  Start/+30Sec. para confirmar.



GRÁFICO DO MENU DE GRELHADOS CROCANTES

VISOR	MENU	PESO
C-1	Cordon bleu	300 g
		600 g
		900 g
C-2	lasanha	200 g
		300 g
		400 g
		500 g
C-3	pão	100 g
C-4	tarte/torta	8 (cerca de 350 g)

GRÁFICO DO MENU AUTOMÁTICO

MENU	VISOR	PESO/ QUANTIDADE	NÍVEL DE POTÊNCIA
A-1 REAQUECIMENTO AUTOMÁTICO	150 g	150 g	P100
	250 g	250 g	
	350 g	350 g	
	450 g	450 g	
	600 g	600 g	
A-2 BATATA	1	1 (cerca de 230 g)	P100
	2	2	
	3	3	
A-3 CARNE	150 g	150 g	P80
	300 g	300 g	
	450 g	450 g	
	600 g	600 g	
A-4 VEGETAIS	150 g	150 g	P100
	350 g	350 g	
	500 g	500 g	
A-5 PEIXE	150 g	150 g	P80
	250 g	250 g	
	350 g	350 g	
	450 g	450 g	
	650 g	650 g	
A-6 MASSA	50 g (em água fria 450 g)	50 g	P80
	100 g (em água fria 800 g)	100 g	
	150 g (em água fria 1200 g)	150 g	
A-7 SOPA	200 g	200 g	P100
	400 g	400 g	
	600 g	600 g	
A-8 BOLO	475 g	475 g	CONVEC.160 °C (Com pré-aquecimento 160 °C)
A-9 PIZZA	100 g	100 g	C-4
	200 g	200 g	
	300 g	300 g	
A10 FRANGO	500 g	500 g	C-4
	750 g	750 g	
	1000 g	1000 g	
	1200 g	1200 g	

10. PESO DE DESCONGELAÇÃO

- a** Prima  Defrost uma vez, é apresentado "dEF1".



- b** Rode o botão para definir o peso dos alimentos, que deve estar entre "100 g-2000 g".

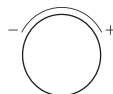

- c** Prima  Start/+30Sec. para começar a descongelação.



NOTA

- O sinal sonoro soa duas vezes para o lembrar de virar os alimentos durante a descongelação.

11. TEMPO DE DESCONGELAÇÃO

- a** Prima  Defrost duas vezes, é apresentado "dEF2".

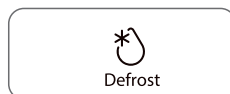

- b** Rode o botão para definir o tempo, o valor de tempo máximo é de "95:00".

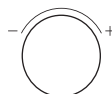

- c** Prima  Start/+30Sec. para começar a descongelação.



Start/+30Sec.



NOTA

- O sinal sonoro soará para o lembrar de virar os alimentos quando tiver passado metade do tempo.
- O nível de potência predefinido é P30, não pode ser alterado.

12. COZEDURA EM VÁRIAS FASES

- a** Prima  Defrost duas vezes, é apresentado "dEF2".

Defrost

- b** Rode o botão para definir a hora, o valor máximo de tempo é "95:00".



- c** Prima  Grill/Conv./Combi para escolher o modo de cozedura.



Grill/Conv./Combi

- d** Prima  Start/+30Sec. para confirmar.

Start/+30Sec.

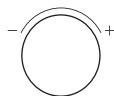
- e Rode o botão para definir a hora, o valor máximo de tempo é "95:00".



- f  Prima Start/+30Sec. para começar a cozinhar.



NOTA

- É possível definir duas fases de cozedura na função de cozedura em várias fases.
- Se definiu a função de descongelação, irá decorrer automaticamente na primeira fase.
- O temporizador de cozinha, o menu automático, a cozedura rápida e o pré-aquecimento não podem ser definidos como uma das várias fases.

13. COZEDURA RÁPIDA

- a Rode o botão para a esquerda uma vez para escolher o modo de cozedura com 100% de potência durante 5 segundos diretamente.

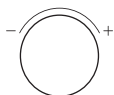

- b Rode o botão para definir o tempo, o valor de tempo máximo é de "95:00".

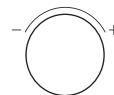

- c  Prima Start/+30Sec. para começar a cozinhar.



- a  Prima Start/+30Sec. uma vez para cozinhar com um nível de potência de 100% durante 30 segundos diretamente.



14. FUNÇÃO DE BLOQUEIO

- a** Para bloquear o micro-ondas de modo a que não possa ser utilizado por crianças ou outros utilizadores acidentalmente, prima o botão  durante 3 segundos, o ícone de bloqueio será apresentado.



- b** Para desbloquear, prima o botão  durante 3 segundos.



15. FUNÇÃO DE CONSULTA

- a** Quando o forno estiver a cozinhar, prima  Timer/Clock, a hora atual aparece durante três segundos no visor.



LIMPEZA

Com bons cuidados e limpeza, o seu aparelho manterá a sua aparência e permanecerá em pleno funcionamento por muito tempo. Explicamos aqui o que deve fazer para cuidar do seu aparelho e limpá-lo corretamente.



- O vidro riscado da porta do aparelho pode rachar. Não use raspadores de vidro, produtos de limpeza afiados ou abrasivos ou detergentes.
- A superfície do aparelho pode ficar danificada se não for limpa adequadamente. A energia das micro-ondas pode escapar. Limpe o aparelho regularmente e remova imediatamente quaisquer restos de alimentos.
- Não mergulhe o aparelho em água nem limpe com jato de água.

Agentes de limpeza

Para garantir que as diferentes superfícies não são danificadas pela utilização de um agente de limpeza errado, observe as informações na tabela. Lave cuidadosamente os panos esponja novos antes da sua utilização.

Não use:



Agentes de limpeza agressivos ou abrasivos



Raspadores de metal ou vidro para limpar os painéis da porta



Raspadores de metal ou vidro para limpar a vedação da porta



Esfregões ou esponjas duros



Agentes de limpeza com alto teor alcoólico

PARTE FRONTAL DO APARELHO

Água quente com sabão:

Limpe com um pano de pratos e depois seque com um pano macio.

Não utilize raspadores de metal ou vidro para limpar.

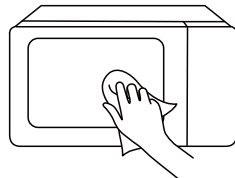

PARTE FORNTAL DO APARELHO COM AÇO INOX

Água quente com sabão:

Limpe com um pano de pratos e depois seque com um pano macio.

Remova imediatamente salpicos e manchas de calcário, gordura, amido e albumina. Pode formar-se corrosão sob essas manchas ou salpicos. Não utilize limpadores de vidro ou raspadores de metal ou vidro para a limpar.

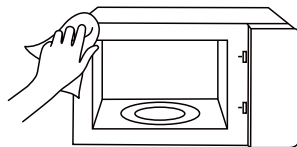

COMPARTIMENTO DE COZIMENTO EM AÇO INOXIDÁVEL

Água quente com sabão ou solução com vinagre:

Limpe com um pano de pratos e depois seque com um pano macio. Não utilize sprays de forno ou outros produtos de limpeza agressivos para forno ou materiais abrasivos. Os esfregões, esponjas ásperas e produtos de limpeza para panelas também são inadequados. Estes artigos arranham a superfície. Deixe as superfícies internas secarem completamente.

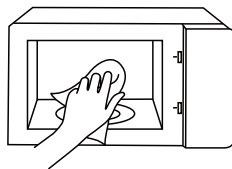

ENTALHE NO COMPARTIMENTO DE COZIMENTO

Pano húmido:

Não deve entrar água no aparelho através do acionamento do prato giratório. Seque a unidade do prato giratório com um pano.

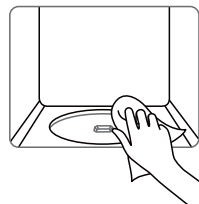

PRATO GIRATÓRIO E ARO DE ROLAMENTOS

Água quente com sabão:

Quando colocar o prato giratório de volta no entalhe, o mesmo deve encaixar corretamente.

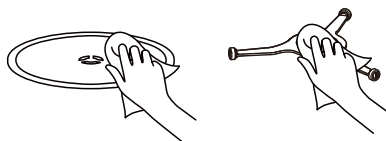

PAINÉIS DA PORTA

Limpador de vidro:

Limpe com um pano de pratos. Não use raspadores de vidro.

RESOLUÇÃO DE PROBLEMAS

Verifique o seu problema usando a tabela abaixo e experimente as soluções para cada problema. Se o forno micro-ondas ainda não funcionar corretamente, entre em contacto com o centro de serviço autorizado mais próximo.

PROBLEMA	CAUSA POSSÍVEL	SOLUÇÃO POSSÍVEL
O forno não liga	<ul style="list-style-type: none">a. O cabo elétrico do forno não está ligado.b. A porta está aberta.c. Foi definida uma operação errada.	<ul style="list-style-type: none">a. Ligue à tomada.b. Feche a porta e tente novamente.c. Verifique as instruções
Arco ou faísca	<ul style="list-style-type: none">a. Foram utilizados materiais a serem evitados em fornos micro-ondas.b. O forno funciona vazio.c. Alimentos derramados permanecem no compartimento.	<ul style="list-style-type: none">a. Use apenas utensílios adequados para micro-ondas.b. Não utilize com o forno vazio.c. Limpe o compartimento com uma toalha húmida.
Alimentos cozinhados de forma irregular	<ul style="list-style-type: none">a. Foram utilizados materiais a serem evitados em fornos micro-ondas.b. Os alimentos não foram descongelados completamente.c. Tempo de cozimento e nível de potência não adequados.d. Os alimentos não foram virados ou mexidos.	<ul style="list-style-type: none">a. Use apenas utensílios adequados para micro-ondas.b. Descongele completamente os alimentos.c. Use o tempo de cozimento e o nível de potência corretos.d. Vire ou mexa os alimentos.
Alimentos cozinhados em demasia	Tempo de cozimento e nível de potência não adequados.	Use o tempo de cozimento e o nível de potência corretos.
Alimentos mal cozinhados	<ul style="list-style-type: none">a. Foram utilizados materiais a serem evitados em fornos micro-ondas.b. Os alimentos não foram descongelados completamente.c. As portas de ventilação do forno estão restritas.d. Tempo de cozimento e nível de potência não adequados.	<ul style="list-style-type: none">a. Use apenas utensílios adequados para micro-ondas.b. Descongele completamente os alimentos.c. Verifique se as portas de ventilação do forno não estão restritas.d. Use o tempo de cozimento e o nível de potência corretos
Descongelamento inadequado	<ul style="list-style-type: none">a. Foram utilizados materiais a serem evitados em fornos micro-ondas.b. Tempo de cozimento e nível de potência não adequados.c. Os alimentos não foram virados ou mexidos.	<ul style="list-style-type: none">a. Use apenas utensílios adequados para micro-ondas.b. Use o tempo de cozimento e o nível de potência corretos.c. Vire ou mexa os alimentos.



De acordo com a diretiva relativa à eliminação de resíduos de equipamentos elétricos e eletrónicos (REEE), estes resíduos devem ser recolhidos e tratados separadamente. Se, em algum momento futuro, precisar de eliminar este produto, NÃO o faça juntamente com o lixo doméstico. Envie este produto para pontos de recolha de REEE, quando disponíveis.

#DetailsMatter

UPUTSTVO ZA UPOTREBU

MIKROTALASNA PEĆNICA

MW3-AC26SF(WH)

Pregledajte ovo uputstvo za upotrebu pre upotrebe.

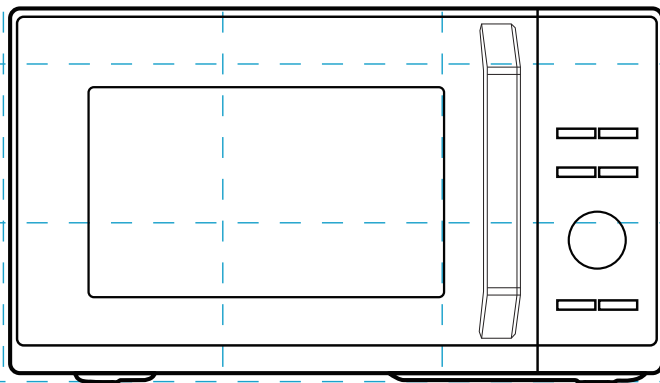

TOSHIBA

SADRŽAJ

BEZBEDNOST PROIZVODA

Mere predostrožnosti za izbegavanje mogućeg izlaganja prekomernoj mikrotalasnoj energiji	SR-01
Važna bezbednosna uputstva	SR-03
Instalacija uzemljenja	SR-08
Čišćenje.....	SR-10
Kuhinjski pribor.....	SR-11
Materijali koje možete koristiti u mikrotalasnoj pećnici	SR-12
Materijali koji se ne mogu koristiti u mikrotalasnoj pećnici	SR-14

PODEŠAVANJE PROIZVODA

Postavljanje pećnice	SR-15
----------------------------	-------

UPUTSTVO ZA KORIŠĆENJE

Pre prve upotrebe	SR-18
Rad.....	SR-19
1. Nivoi snage.....	SR-20
2. Podešavanje sata	SR-20
3. Kuhinjski tajmer.....	SR-21
4. Kuvanje u mikrotalasnoj pećnici	SR-22
5. ROŠTILJ ILI KOMBINOVANO	SR-22
6. Konvekcija sa prethodnim zagrevanjem.....	SR-23
7. Konvekcija bez prethodnog zagrevanja.....	SR-24
8. Meni Airfry.....	SR-25
9. Automatski meni i meni za hrskavi roštilj	SR-26
10. Odmrzavanje po težini	SR-28
11. Vreme odmrzavanja	SR-28
12. Višefazno kuvanje	SR-29

13. Brzo kvanje.....	SR-30
14. Funkcija zaključavanja.....	SR-31
15. Funkcija upita	SR-31

ČIŠĆENJE I ODRŽAVANJE

Čišćenje.....	SR-32
Rešavanje problema.....	SR-34



NAPOMENA

PRE UPOTREBE OVOG PROIZVODA, PROČITAJTE, SHVATITE I SLEDITE OVA UPUTSTVA. OBAVEZNO SAČUVAJTE OVU KNJIŽICU ZA BUDUĆU UPOTREBU.

BEZBEDNOST PROIZVODA

MERE PREDOSTROŽNOSTI ZA IZBEGAVANJE MOGUĆEG IZLAGANJA PREKOMERNOJ MIKROTALASNOJ ENERGIJI

- (a). Ne pokušavajte da koristite ovu pećnicu sa otvorenim vratima jer to može dovesti do štetnog izlaganja mikrotalasnoj energiji. Važno je da ne lomite ili neovlašćeno rukujete sigurnosnim blokadama.
- (b). Ne stavljajte nikakve predmete između prednje strane pećnice i vrata i ne dozvolite da se prljavština ili ostaci sredstva za čišćenje nakupljaju na zaptivnim površinama.
- (c). **UPOZORENJE:** Ako su vrata ili zaptivke vrata oštećene, pećnica ne sme da se koristi dok je ne popravi stručna osoba.

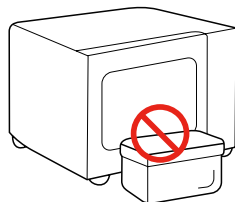

DODATAK

Ako se uređaj ne održava u čistom stanju, njegova površina može degradirati, što može uticati na životni vek uređaja i dovesti do opasne situacije.

SPECIFIKACIJE

MODEL	MW3-AC26SF(WH)
NOMINALNI NAPON/FREKVENCIJA	230-240 V~ 50 Hz
NAZIVNA ULAZNA SNAGA (MIKROTALASI)	1450 W
NAZIVNA IZLAZNA SNAGA (MIKROTALASI)	900 W
NAZIVNA ULAZNA SNAGA (ROŠTILJ)	1000 W
NAZIVNA ULAZNA SNAGA (KONVEKCIJA)	2100 W



NAPOMENA

Sve slike u ovom uputstvu služe samo u ilustrativne svrhe; one se mogu malo razlikovati od kupljene opreme, pogledajte stvarni proizvod.

VAŽNA BEZBEDNOSNA UPUTSTVA



UPOZORENJE

Da biste smanjili rizik od požara, strujnog udara, povreda osoba ili izlaganja prekomernoj energiji mikrotalasne pećnice kada koristite uređaj, pratite osnovne mere opreza, uključujući sledeće:



Pročitajte i sledite konkretno: „**MERE PREDOSTROŽNOSTI ZA IZBEGAVANJE MOGUĆEG IZLAGANJA PREKOMERNOJ MIKROTALASNOJ ENERGIJI**“.



Deca od 8 godina i starija, kao i osobe sa smanjenim fizičkim, čulnim ili mentalnim sposobnostima ili bez dovoljnog iskustva i znanja mogu da koriste ovaj uređaj samo ako su pod nadzorom ili su im data uputstva u vezi sa korišćenjem uređaja na bezbedan način i ako razumeju opasnosti koje pri tome postoje. Deca ne smeju da se igraju ovim uređajem.



korisničko održavanje ne smeju da obavljaju deca bez nadzora.



Držite uređaj i njegov kabl van domašaja dece mlađe od 8 godina.





Ako je kabl za napajanje oštećen, potrebno je da ga zameni proizvođač, ovlašćeni serviser ili druga kvalifikovana osoba kako bi se izbegla opasnost.



UPOZORENJE: Uverite se da je uređaj isključen pre zamene lampe kako biste izbegli mogućnost strujnog udara.

VAŽNA BEZBEDNOSNA UPUTSTVA

 **UPOZORENJE:** Opasno je za bilo koga osim za kompetentno lice da izvrši bilo kakvu operaciju servisiranja ili popravke koja uključuje uklanjanje poklopca koji pruža zaštitu od izlaganja mikrotalasnoj energiji.

 **UPOZORENJE:** Tečnosti i druga hrana se ne smeju zagrevati u zatvorenim posudama jer mogu eksplodirati.

 Kada zagrevate hranu u plastičnim ili papirnim posudama, pazite na pećnicu zbog mogućnosti paljenja.



 Koristite samo pribor koji je pogodan za upotrebu u mikrotalasnim pećnicama.

 Ako se pojavi dim, isključite ili iskopčajte uređaj iz struje i držite vrata zatvorena kako biste prigušili plamen.

 Zagrevanje pića u mikrotalasnoj pećnici može dovesti do odloženog eruptivnog ključanja, stoga morate biti oprezni pri rukovanju posudom.

 Sadržaj flašica za hranjenje i tegli sa hranom za bebe treba promešati ili protresti i proveriti temperaturu pre konzumiranja, kako bi se izbegle opekotine.

VAŽNA BEZBEDNOSNA UPUTSTVA

 Pećnicu treba redovno čistiti i uklanjati sve naslage hrane.

Područje talasovoda treba da bude čisto. Koristite meku vlažnu krpu da biste je očistili kada postoje ostaci prskanja hrane na području talasovoda ili u unutrašnjosti. Ako ne očistite ostatke hrane, može doći do bezopasnog iskrenja ili pojave dima u unutrašnjosti mikrotalasne rerne, a može doći i do promene boje šupljine.

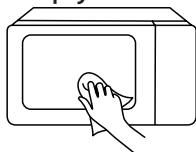

 Neodržavanje pećnice u čistom stanju može dovesti do propadanja površine što može negativno uticati na vek trajanja uređaja i može dovesti do opasne situacije.

 Koristite samo temperaturnu sondu preporučenu za ovu pećnicu. (za pećnice koje imaju mogućnost korišćenja sonde sa senzorom temperature.)

 Mikrotalasna pećnica mora da radi sa otvorenim ukrasnim vratima. (Za pećnice sa ukrasnim vratima.)

 Ovaj uređaj namenjen je za upotrebu u domaćinstvu i sličnim primenama kao što su:

1. kuhinje za osoblje u prodavnicama, kancelarijama i drugim radnim okruženjima;
2. od strane klijenata u hotelima, motelima i drugim okruženjima stambenog tipa;
3. seoske kuće;
4. ugostiteljski objekti koji pružaju noćenje sa doručkom.

VAŽNA BEZBEDNOSNA UPUTSTVA

 Mikrotalasna pećnica je namenjena za zagrevanje hrane i pića. Isušivanje hrane, sušenje odeće, zagrevanje grejnih jastučića, papuča, sunđera, vlažnih krpa i sličnog može dovesti do rizika od povreda, paljenja ili požara.

 Uređaj treba da stoji samostalno.

 Zadnja površina uređaja treba da bude postavljena uz zid.

 Temperatura dostupnih površina može biti visoka kada aparat radi.

 **UPOZORENJE:** Kada uređaj radi u kombinovanom režimu,

deca bi trebalo da koriste pećnicu samo pod nadzorom odrasle osobe zbog visokih temperatura.

 Jaja u ljusci i cela tvrdo kuvana jaja ne treba zagrevati u mikrotalasnoj pećnici jer mogu eksplodirati čak i nakon što se mikrotalasno zagrevanje završi.

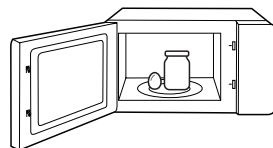



 Uređaj se ne sme postavljati iza ukrasnih vrata kako bi se izbeglo pregrevanje. (Ovo se ne odnosi na uređaje sa ukrasnim vratima.)

VAŽNA BEZBEDNOSNA UPUTSTVA

 Mikrotalasna rečna se ne sme stavljati u kuhinjski element osim ako nije testirana za to.

 Metalne posude za hranu i napitke nisu dozvoljene tokom kuvanja u mikrotalasnoj pećnici.

 Uređaj se ne sme čistiti parnim čistačem.

 Nije predviđeno da se aparatima upravlja pomoću spoljnog tajmera ili posebnog sistema daljinskog upravljanja.

PAŽLJIVO PROČITAJTE I SAČUVAJTE
ZA BUDUĆU UPOTREBU

DA BI SE SMANJIO RIZIK OD POVREDA OSOBA KOJE UZEMLJUJU INSTALACIJU

Ovaj aparat mora da bude uzemljen. U slučaju kratkog spoja, uzemljenje smanjuje rizik od strujnog udara putem odvodne žice za električnu struju.

Ovaj aparat je opremljen strujnim kablom i utikačem sa kontaktom za uzemljenje. Utikač mora da se priključi u utičnicu koja je pravilno instalirana i uzemljena.

UPOZORENJE - Nepravilna upotreba uzemljenja može da dovede do rizika od strujnog udara. Konsultujte se sa kvalifikovanim električarem ili serviserom ako u potpunosti ne razumete uputstva za uzemljenje ili ako niste sigurni da li je aparat pravilno uzemljen.

Ako je potrebno da se koristi produžni kabl, koristite isključivo produžni kabl sa tri žice.



OPASNOST

Opasnost od strujnog udara:

Dodirivanje nekih unutrašnjih komponenti može da dovede do ozbiljne fizičke povrede ili smrti.

Nemojte rastavljati ovaj aparata.

DA BI SE SMANJIO RIZIK OD POVREDA OSOBA KOJE UZEMLJUJU INSTALACIJU



**UPOZO-
RENJE**

Opasnost od strujnog udara:

Neispravno uzemljenje može da dovde do strujnog udara. Nemojte uključivati aparat u utičnicu dok nije pravilno instaliran i uzemljen.

1. Obezbeđen je kratak kabl za napajanje kako bi se smanjili rizici koji nastaju usled uplitanja ili spoticanja o duži kabl.
2. Ako se koristi dugačak kabl ili produžni kabl:
 - (1). Nominalna snaga strujnog kabla ili produžnog kabla mora biti jednaka ili veća od nominalne snage aparata.
 - (2). Produžni kabl mora da bude trožični kabl za uzemljenje.
 - (3). Duži kabl treba da se sprovede tako da ne visi preko radne površine ili stola gde deca mogu da ga povuku ili neko može slučajno da se saplete o njega.

ČIŠĆENJE

Obavezno isključite aparat iz napajanja.

1. Nakon upotrebe očistite unutrašnjost rerne blago vlažnom krpom.
2. Dodatke očistite na uobičajen način u vodi sa sapunicom.
3. Kada su prljavi, okvir vrata, zaptivku i okolni delovi moraju se pažljivo očistiti vlažnom krpom.
4. Ne koristite gruba, abrazivna sredstva za čišćenje i oštre metalne strugače za čišćenje stakla na vratima pećnice, jer mogu da ogrebu površinu, što može da izazove razbijanje stakla.
5. Savet za čišćenje--- Za lakše čišćenje zidova unutrašnjosti koje kuvana hrana može da dodirne: Stavite pola limuna u posudu, dodajte 300 ml vode i zagrevajte na 100% snage mikrotalasa na 10 minuta. Obrišite rernu mekom, suvom krpom.

POSUĐE



Opasnost od fizičke povrede:
Servisiranje ili popravljavanje koje uključuje uklanjanje poklopca koji štiti od izlaganja mikrotalasnoj energiji, opasno je za svakog osim za stručno lice. Pogledajte uputstva o „ **Materijali koje možete da koristite u mikrotalasnoj rerni** “ili „ **Materijali koji se ne mogu koristiti u mikrotalasnoj rerni** “

Postoji određeno nemetalno posuđe koje nije bezbedno za upotrebu u mikrotalasnoj rerni. Ako niste sigurni, možete testirati tu posudu prateći postupak u nastavku.

Test posuđa:



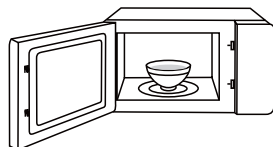



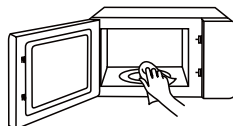









1. Napunite posudu bezbednu za upotrebu u mikrotalasnoj rerni 1 šoljicom hladne vode (250 ml), zajedno sa posudom koju proveravate.
2. Kuvajte na maksimalnoj snazi 1 minut.
3. Pažljivo opipajte posudu. Ako je prazna posuda topla, nemojte je koristiti za kuvanje u mikrotalasnoj rerni.
4. Ne prekoračujte 1 minut kuvanja.



ODRŽAVAJTE UNUTRAŠNJOST I
PODRUČJE TALASOVODA ČISTIM



MATERIJALI KOJE MOŽETE DA KORISTITE U MIKROTALASNOJ RERNI

POSUĐE	NAPOMENE	
 Posuda koja služi da se u njoj zapeče jelo	Pratite uputstva proizvođača. Dno posude za pečenje mora da bude najmanje 5 mm iznad rotirajućeg tanjira. Nepravilna upotreba može dovesti do pucanja rotirajućeg tanjira.	
 Pribor za jelo	Isključivo onaj koji je pogodan za upotrebu u mikrotalasnim rernama. Pratite uputstva proizvođača. Nemojte koristiti naprslo ili okrnjeno posuđe.	
 Staklene tegle	Uvek uklonite poklopac. Koristite za zagrevanje hrane dok ne bude topla. Većina staklenih tegli nije otporna na toplotu i mogu da puknu.	
 Stakleno posuđe	Koristite isključivo vatrostalno stakleno posuđe. Na posudama nikako ne sme biti metalnih rubova. Nemojte koristiti naprslo ili okrnjeno posuđe.	
 Kese za kuvanje u rerni	Pratite uputstva proizvođača. Ne zatvarajte metalnom vezicom. Napravite proreze kako bi para mogla da izlazi.	
 Papirni tanjiri i šolje	Koristite samo za kratkotrajno kuvanje/zagrevanje. Ne ostavljajte rernu bez nadzora tokom kuvanja.	
 Papirni ubrusi	Koristite za prekrivanje hrane za podgrevanje i upijanje masnoće. Koristite uz nadzor isključivo za kratkotrajno kuvanje.	
 Papir za kolače	Koristite kao poklopac kako biste sprečili prskanje ili kao omot za kuvanje u pari.	

MATERIJALI KOJE MOŽETE DA KORISTITE U MIKROTALASNOJ RERNI

POSUĐE

NAPOMENE



Plastika

Isključivo onaj koji je pogodan za upotrebu u mikrotalasnim rernama. Pratite uputstva proizvođača. Treba da bude označeno sa „Microwave Safe“. Neke plastične posude omekšaju dok se hrana u njima podgreva. „Kese za kuvanje“ i čvrsto zatvorene plastične kese treba da se prorežu, probuše ili ostave otvorenim prema uputstvu na pakovanju.



Plastična folija

Isključivo onaj koji je pogodan za upotrebu u mikrotalasnim rernama. Koristite za prekrivanje hrane tokom kuvanja radi zadržavanja vlage. Plastična folija ne bi trebalo da dodiruje hranu.

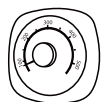

Termometri

Isključivo onaj koji je pogodan za upotrebu u mikrotalasnim rernama (termometri za meso i kolače).

















Voštani papir

Koristite kao poklopac kako biste sprečili prskanje i zadržali vlagu.

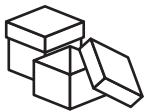

MATERIJALI KOJI SE NE MOGU KORISTITI U MIKROTALASNOJ RERNI

POSUDE	NAPOMENE	
 Aluminijumska posuda	Može da izazove varničenje. Prebacite hranu u posudu bezbednu za mikrotalasnu rernu.	
 Posude za hranu sa metalnom drškom	Može da izazove varničenje. Prebacite hranu u posudu bezbednu za mikrotalasnu rernu.	
 Metalne posude ili posude sa metalnom ivicom	Metal štiti hranu od mikrotalasne energije. Metalne ivice mogu da izazovu varničenje.	
 Metalne vezice	Mogu da izazovu varničenje i vatru unutar rerne.	
 Papirnate kese	Može da izazove vatru unutar rerne.	
 Stiropor	Stiropor može da se otopi ili kontaminira tečnost unutar rerne kada je izložen visokoj temperaturi.	
 Drvo	Drvo će se osušiti kada se koristi u mikrotalasnoj rerni i može da se rascepi ili naprsne.	

PODEŠAVANJE PROIZVODA

POSTAVLJANJE PEĆNICE

(U slučaju bilo kakvih razlika između uređaja i slika u ovom priručniku, proizvod će imati prednost.)

NAZIVI DELOVA I PRIBORA PEĆNICE

Izvadite pećnicu i sve materijale iz ambalaže i unutrašnjosti rerne.

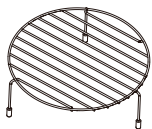

Viša rešetka za roštilj

Rešetka za roštilj (ne može se koristiti sa mikrotalasnom funkcijom i mora da se postavi na staklenu tacnu)

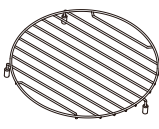

Donja rešetka za roštilj

Rešetka za roštilj (ne može se koristiti sa mikrotalasnom funkcijom i mora da se postavi na staklenu tacnu)

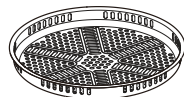

Posuda za pečenje (ne može se koristiti zajedno sa mikrotalasnom funkcijom i može se postaviti na rešetku za roštilj)



Staklena tacna

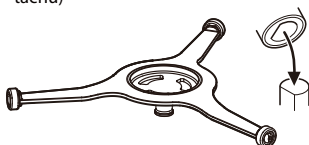

Sklop prstena obrtnog postolja



Uputstvo za upotrebu

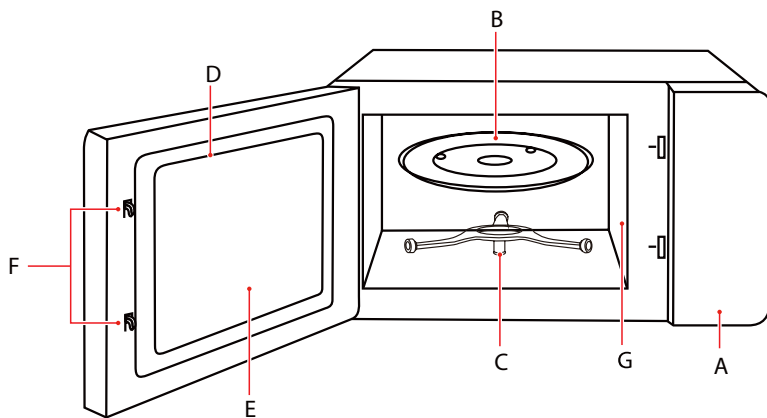

A) Kontrolna tabla

B) Staklena tacna

C) Sklop prstena obrtnog postolja

D) Sklop vrata

E) Prozor za posmatranje

F) Sistem sigurnosne brave

G) Poklopac talasovoda

POSTAVLJANJE PEĆNICE

INSTALACIJA OBRTOG POSTOLJA

Očistite odeljka za kuvanje i postavite obrtno postolje na mesto.

Pri montaži novog uređaja, uverite se da su sva ambalaža i trake za transport uklonjene sa osovine obrtnog postolja.

Pre upotrebe uređaja za pripremu hrane po prvi put, moraćete da pravilno postavite obrtno postolje. Morate očistiti odeljak za kuvanje i pribor. Možete ih uputiti i na odeljak za čišćenje.

Kako postaviti obrtno postolje na svoje mesto:

1. Postavite sklop prstena obrtnog postolja ② u udubljenje u odeljku za kuvanje.
2. Postavite staklenu tacnu ① na sklopove prstena obrtnog postolja ②.

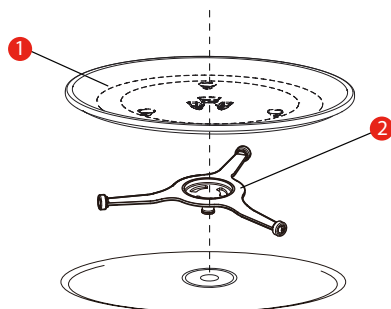

- 1) Staklena tacna
- 2) Sklop prstena obrtnog postolja

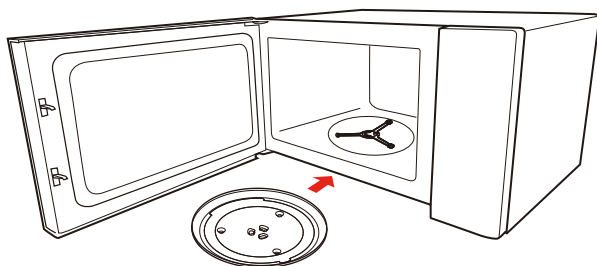

NAPOMENA

- Nikada ne koristite uređaj bez obrtnog postolja. Osigurajte da pravilno naleže. Obrtno postolje se može okretati u smeru kazaljke na satu ili suprotno.
- Nikada ne postavljajte staklenu tacnu naopako. Staklena tacna nikada ne bi trebalo da bude blokirana.
- I staklena tacna i sklop prstena obrtnog postolja moraju se uvek koristiti tokom kuvanja.
- Sva hrana i posude sa hranom uvek se stavljaju na staklenu tacnu za kuvanje.
- Nikada ne ograničavajte kretanje obrtnog postolja.
- Ako staklena tacna ili sklop prstena obrtnog postolja napuknu ili se polome, kontaktirajte najbliži ovlašćeni servisni centar.

INSTALACIJA NA RADNU POVRŠINU

Uklonite svu ambalažu i pribor. Pregledajte pećnicu da li ima oštećenja kao što su ulubljenja ili slomljena vrata. Nemojte instalirati pećnicu ako je oštećena.

Kućište: Uklonite svu zaštitnu foliju sa površine kućišta mikrotalasne pećnice. Nemojte uklanjati poklopac talasovoda koji je pričvršćen za unutrašnjost pećnice kako biste zaštitili magnetron.

INSTALACIJA

1. Izaberite ravnu površinu koja ima dovoljno slobodnog prostora za ulazne i/ili izlazne otvore.

a. Minimalna visina ugradnje je 85 cm.

b. Zadnja površina aparata se postavlja uz zid. Ostavite minimalni slobodni prostor od 30 cm iznad rene. Potreban je minimalni slobodan prostor od 20 cm između pećnice i bilo kojih susjednih zidova.

c. Ne skidajte nogare sa dna pećnice.

d. Blokiranje ulaznih i/ili izlaznih otvora može oštetiti pećnicu.

e. Postavite pećnicu što dalje od radija i TV-a. Rad mikrotalasne pećnice može uzrokovati smetnje vašem radio ili TV prijemu.

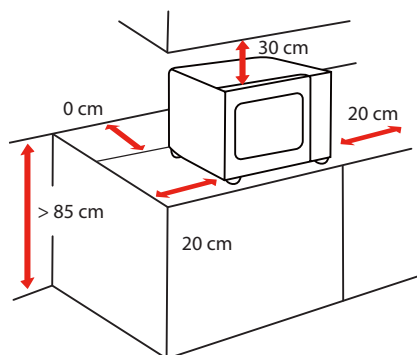

2. Uključite pećnicu u standardnu kućnu utičnicu. Uverite se da su napon i frekvencija isti kao napon i frekvencija na nazivnoj oznaci.



NAPOMENA

• Ne postavljajte pećnicu iznad ploče za kuvanje ili drugog uređaja koji proizvodi toplotu.

Ako se pećnica postavi u blizini ili iznad izvora toplote, pećnica se može oštetiti, a garancija će bila nevažeća.

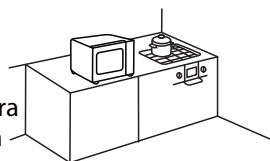

Dostupna površina može biti
vruća tokom rada

UPUTSTVO ZA KORIŠĆENJE

PRE PRVE UPOTREBE

Pećnica može da proizvede neprijatne mirise kada se prvi put koristi, i to je normalno.

U ovom odeljku ćete saznati šta treba da uradite pre prve upotrebe mikrotalasne rerne za pripremu hrane. Prethodno pročitajte odeljak pod nazivom „**BEZBEDNOST PROIZVODA**“.

Da biste mogli da koristite svoj novi aparat, morate pravilno da postavite obrtno postolje. Takođe morate da očistite odeljak za kuvanje i pribor.



NAPOMENA

- Nikada ne koristite uređaj bez obrtnog postolja.
- Osigurajte da pravilno naleže. Obrtno postolje se može okretati u smeru kazaljki na satu ili suprotno.

RAD

KONTROLNA TABLA I FUNKCIJE

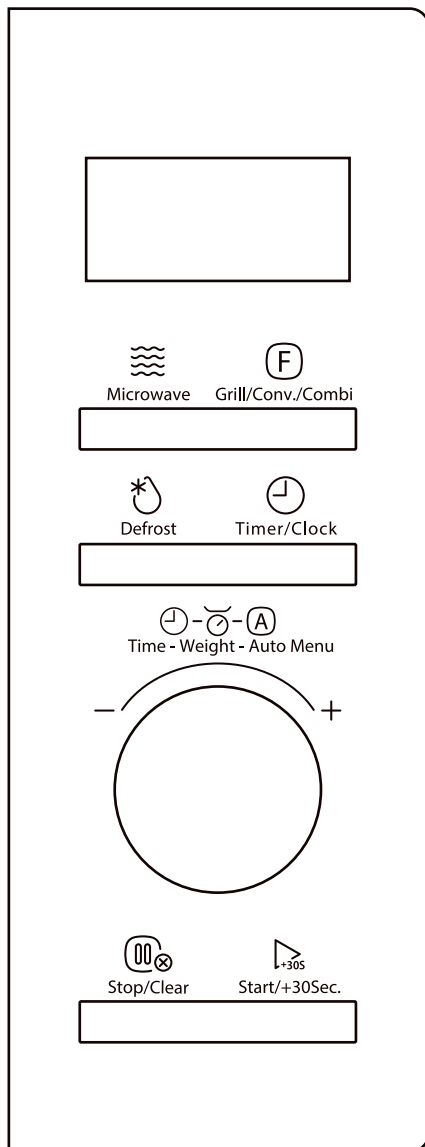

1. NIVOI SNAGE

Dostupno je pet nivoa snage.

SNAGE	NIVO	PRIKAZ
1	100%	P100
2	80%	P80
3	50%	P50
4	30%	P30
5	10%	P10

2. PODEŠAVANJE SATA

Kada je mikrotalasna pećnica priključena u utičnicu, prikazaće se „0:00“.

- a** Pritisnite  dva puta, prikazaće se 00:00.



- b** Okrenite dugme da biste podesili broj sati, a uneta vrednost treba da bude u opsegu 0–23.

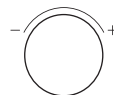

- c** Pritisnite  ili  da biste potvrdili vrednosti sati.



- d** Okrenite dugme da biste podesili minute, a uneta vrednost treba da bude u opsegu 0–59

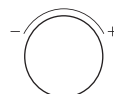

e Pritisnite  Start/+30Sec. ili  Timer/Clock da biste potvrdili.



- Kada je pećnica uključena, ako sat nije podešen, ona neće raditi.
- Tokom podešavanja sata, ako se ne izvede nijedna operacija u roku od 5 minuta ili direktno pritisnete , prikaz će se automatski vratiti na prethodno podešavanje sata.

3. KUHINJSKI TAJMER

Kada je mikrotalasna pećnica priključena u utičnicu, prikazaće se „0:00“.

a Pritisnite  Timer/Clock jednom



b Okrenite dugme da biste podesili vreme, trebalo bi da bude između 0:05-95:00.

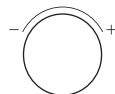









c Pritisnite  Start/+30Sec. da biste započeli sa odbrojavanjem





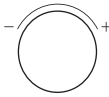

- Podešavanje kuhinjskog tajmera se razlikuje od podešavanja sata; to je jednostavno tajmer.
- Tokom funkcionisanja kuhinjskog tajmera, nijedna funkcija kuvanja ne može da se podesi.

4. KUVANJE U MIKROTALASNOJ PEĆNICI

Kada je mikrotalasna pećnica priključena u utičnicu, prikazaće se „0:00“.

- a** ili
- Pritisnite  više puta da biste izabrali nivo snage.
- ili
- Pritisnite  jednom, a zatim okrenite dugme da biste podesili nivo snage.
- b** Pritisnite  da biste potvrdili nivo snage.
- c** Okrenite dugme da biste podesili vreme, maksimalna vrednost vremena je „95:00“.
- d** Pritisnite  da biste započeli kuvanje.
- 
- 
- 
- 
- 

5. ROŠTILJ ILI KOMBINOVANO

- a** ili
- Pritisnite  više puta da biste izabrali režim.
- ili
- Pritisnite  jednom, a zatim okrenite dugme da biste izabrali režim.
- Redom će se prikazati „G-1, C-1...C-4, 150°C, 160°C.....240°C“. („G-1“ je roštilj, „C-1~C-4“ je kombinovano).
- 
- 

b Pritisnite  Start/+30Sec. da biste potvrdili režim.



c Okrenite dugme da biste podesili vreme, maksimalna vrednost vremena je „95:00“.

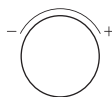

d Pritisnite  Start/+30Sec. da biste započeli kuvanje.



 **NAPOMENA**

- Kada prođe polovina vremena, zvučni signal će se oglasiti da vas podsetiti da okrenete hranu. Ako ne izvršite tu radnju, pećnica će nastaviti da radi.

6. KONVEKCIJA SA PRETHODNIM ZAGREVANJEM

a Pritisnite  Grill/Conv./Combi više puta da biste izabrali temperaturu konvekcije.



ili

a Pritisnite  Grill/Conv./Combi jednom, a zatim okrenite dugme da biste izabrali temperaturu konvekcije. Dostupne su temperature 150°C, 160°C.....240°C.



b Pritisnite  Start/+30Sec. dva puta da biste započeli prethodno zagrevanje.



Kada se prethodno zagrevanje završi, temperatura će treperiti, otvorite vrata i stavite hranu u pećnicu.

- c** Okrenite dugme da biste podesili vreme, maksimalna vrednost vremena je „95:00“.

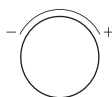

- d** Pritisnite  Start/+30Sec. da biste započeli kuvanje.



7. KONVEKCIJA BEZ PRETHODNOG ZAGREVANJA

- f** Pritisnite  Grill/Conv./Combi više puta da biste izabrali temperaturu konvekcije.



a ili

- f** Pritisnite  Grill/Conv./Combi jednom, a zatim okrenite dugme da biste izabrali temperaturu konvekcije. Dostupne su temperature 150°C, 160°C.....240°C.



- b** Pritisnite  Start/+30Sec. da biste potvrdili temperaturu.



- c** Okrenite dugme da biste podesili vreme, maksimalna vrednost vremena je „95:00“.

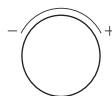



- d** Pritisnite  Start/+30Sec. da biste započeli kuvanje.

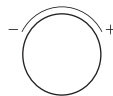

8. MENI AIRFRY

- a** U režimu čekanja, okrenite dugme udesno da biste ušli u funkciju menija. Okrećite dugme više puta da biste izabrali tip menija H-1.



- b** Pritisnite  Start/+30Sec. da biste potvrdili tip menija



- c** Okrenite dugme da biste izabrali podmeni.

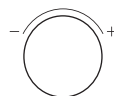

- d** Pritisnite  Start/+30Sec. da biste započeli kuvanje.



TABELA MENIJA AIRFRY

PRIKAZ	MENI	TEŽINA
H-1	Smrznuti pomfrit	300 g
H-2	Kroketi od smrznutog krompira	350 g
H-3	Smrznuta lignja	250 g
H-4	Zamrznuti kolutići od luka	250 g
H-5	Smrznuti pileći medaljoni	350 g
H-6	Odresci	400 g
H-7	Škampi	250 g
H-8	Povrće	200 g
H-9	Proletne rolice	300 g

Napomena: Težina menija kuvanja na vruć vazduh (airfry) se ne može podesiti.

9. AUTOMATSKI MENI I MENI ZA HRSKAVI ROŠTILJ

- a** U režimu čekanja, okrenite dugme udesno da biste ušli u funkciju menija. Okrećite dugme više puta da biste izabrali automatski meni (prikazuje se A-1) ili meni za hrskavi roštilj (prikazuje se C-1). Na primer, izaberite C-1.

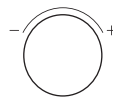

- b** Pritisnite  Start/+30Sec. da biste potvrdili.



- c** Okrenite dugme da biste izabrali podmeni, dostupni su C-1~C-4.

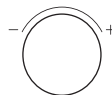

- d** Pritisnite  Start/+30Sec. da biste potvrdili. Okrenite dugme da biste izabrali težinu. Težina C-3 i C-4 se ne mogu podesiti.



- e** Pritisnite  Start/+30Sec. da biste potvrdili.



GRAFIKON MENIJA ZA HRSKAVI ROŠTILJ

PRIKAZ	MENI	TEŽINA
C-1	Cordon bleu	300 g
		600 g
		900 g
C-2	lazanje	200 g
		300 g
		400 g
		500 g
C-3	hleb	100 g
C-4	pita/tart	8 (oko 350 g)

TABELA AUTOMATSKOG MENIJA

MENI	PRIKAZ	TEŽINA/ KOLIČINA	NIVO SNAGE
A-1 AUTOMATSKO PODGREVANJE	150 g	150 g	P100
	250 g	250 g	
	350 g	350 g	
	450 g	450 g	
	600 g	600 g	
A-2 KROMPIR	1	1 (oko 230 g)	P100
	2	2	
	3	3	
A-3 MESO	150 g	150 g	P80
	300 g	300 g	
	450 g	450 g	
	600 g	600 g	
A-4 POVRĆE	150 g	150 g	P100
	350 g	350 g	
	500 g	500 g	
A-5 RIBA	150 g	150 g	P80
	250 g	250 g	
	350 g	350 g	
	450 g	450 g	
	650 g	650 g	
A-6 TESTENINA	50 g (sa hladnom vodom 450 g)	50 g	P80
	100 g (sa hladnom vodom 800 g)	100 g	
	150 g (sa hladnom vodom 1200 g)	150 g	
A-7 SUPA	200 g	200 g	P100
	400 g	400 g	
	600 g	600 g	
A-8 TORTA	475 g	475 g	CONVEC.160°C (Sa prethodnim zagrevanjem na 160°C)
A-9 PICA	100 g	100 g	C-4
	200 g	200 g	
	300 g	300 g	
A10 PILETINA	500 g	500 g	C-4
	750 g	750 g	
	1000 g	1000 g	
	1200 g	1200 g	

10. ODMRZAVANJE PO TEŽINI

- a** Pritisnite  Defrost jednom, prikazaće se „dEF1“.



- b** Okrenite dugme da biste podesili težinu hrane, treba da bude unutar „100 g-2000 g“.

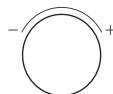

- c** Pritisnite  Start/+30Sec. da biste započeli odmrzavanje.



NAPOMENA

- Zvučni signal će se oglasiti da vas podseti da okrenete hranu tokom odmrzavanja.

11. VREME ODMRZAVANJA

- a** Pritisnite  Defrost dva puta, prikazaće se „dEF2“.

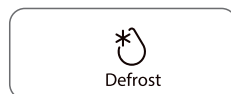

- b** Okrenite dugme da biste podesili vreme. Maksimalna vrednost vremena je „95:00“.

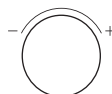

- c** Pritisnite  Start/+30Sec. da biste započeli odmrzavanje.



Start/+30Sec.



NAPOMENA

- Zvučni signal će se oglasiti da okrenete hranu kada prođe polovina vremena.
- Podrazumevani nivo snage je P30, ne može se promeniti.

12. VIŠEFAZNO KUVANJE

- a** Pritisnite  Defrost dva puta, prikazaće se „dEF2“.

Defrost

- b** Okrenite dugme da biste podesili vreme, maksimalna vrednost vremena je „95:00“.



- c** Pritisnite  Grill/Conv./Combi da biste izabrali režim kuvanja.



Grill/Conv./Combi

- d** Pritisnite  Start/+30Sec. da biste potvrdili.

Start/+30Sec.

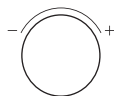
- e** Okrenite dugme da biste podesili vreme, maksimalna vrednost vremena je „95:00“.



- f** Pritisnite  Start/+30Sec. da biste započeli kuvanje.



- U višefaznom kuvanju mogu se podesiti dve faze kuvanja.
- Ako podesite funkciju odmrzavanja, ona će raditi automatski u prvoj fazi.
- Kuhinjski tajmer, automatski meni, brzo kuvanje i prethodno zagrevanje se ne mogu podesiti kao jedna od faza.

13. BRZO KUVANJE

- a** Okrenite dugme ulevo jednom da biste direktno izabrali režim kuvanja sa 100% nivoa snage na 5 sekundi.

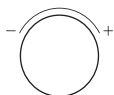

- b** Okrenite dugme da biste podesili vreme. Maksimalna vrednost vremena je „95:00“.

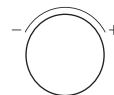

- c** Pritisnite  Start/+30Sec. da biste započeli kuvanje.



- a** Pritisnite  Start/+30Sec. jednom da biste direktno izabrali režim kuvanja sa 100% nivoa snage na 30 sekundi.



14. FUNKCIJA ZAKLJUČAVANJA

- a** Da biste zaključali mikrotalasnu pećnicu tako da njome ne mogu da upravljaju deca ili drugi neželjeni korisnici, pritisnite na podlogu  na 3 sekunde i prikazaće se ikona zaključane pećnice.



- b** Da biste otključali, pritisnite na podlogu  na 3 sekunde.



15. FUNKCIJA UPITA

- a** Dok se kuva u pećnici, pritisnite  Timer/Clock, na ekranu će se prikazati vreme kuvanja u trajanju od tri sekunde.



ČIŠĆENJE

Uz dobru negu i čišćenje, vaš aparat će zadržati svoj izgled i ostati u potpunosti funkcionalan još dugo vremena. Ovdje ćemo objasniti kako treba pravilno da održavate i čistite svoj aparat.



- Ogrebano staklo na vratima aparata može da dovede do pojave pukotine. Nemojte koristiti strugač za staklo, oštra ili abrazivna sredstva za čišćenje ili deterdžente.
- Površina aparata može se oštetiti ako nije pravilno očišćena. Energija mikrotalasa može da izađe. Redovno čistite aparat i odmah uklonite ostatke hrane.
- Ne potapajte aparat u vodu niti ga čistite pod mlazom vode.

Sredstvo za čišćenje

Kako se različite površine ne bi oštetile korišćenjem pogrešnog sredstva za čišćenje, pridržavajte se informacija u nastavku. Temeljno operite nove sunđeraste krpe pre upotrebe.

Nemojte koristiti:



Gruba ili abrazivna sredstva za čišćenje



Metalne strugače ili strugače za staklo za čišćenje panela vrata



Metalni strugači ili strugači za staklo za čišćenje zaptivke vrata



Tvrđi jastučići za ribanje ili sunđeri



Sredstva za čišćenje sa visokim sadržajem alkohola

PREDNJA STRANA APARATA

Vruća voda sa sapunicom:

Očistite krpom za posuđe, a zatim osušite mekom krpom. Nemojte koristiti metalne strugače ili strugače za staklo za čišćenje.

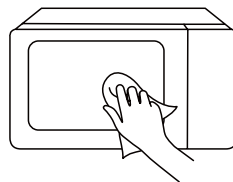

ČIŠĆENJE

PREDNJI PANEL APARATA

Vruća voda sa sapunicom:

Očistite krpom za posuđe, a zatim osušite mekom krpom. Odmah uklonite prskanja i mrlje od kamenca, masti, skroba i albumina. Može doći do pojave korozije ispod ovih mrlja ili prskanja. Za čišćenje nemojte koristiti sredstva za čišćenje stakla ili metalne strugače ili strugače za staklo.

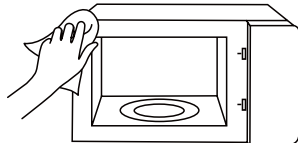

UNUTRAŠNJOST APARATA

Vruća voda sa sapunicom ili rastvor sa sirćetom:

Očistite krpom za posuđe, a zatim osušite mekom krpom. Nemojte koristiti sprej za rernu ili bilo koja druga agresivna sredstva za čišćenje rerne ili abrazivne materijale. Jastučići za ribanje, grubi sunđeri i sredstva za čišćenje tiganja takođe nisu pogodni. Ovi predmeti grebu površinu. Ostavite da se unutrašnje površine potpuno osuše.

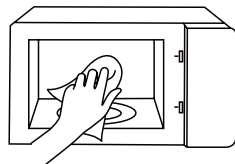

UDUBLJENJE U ODELJKU ZA KUVANJE

Vlažna krpa:

Voda ne sme da ulazi u aparat kroz pogon rotirajućeg tanjira. Osušite pogon rotirajućeg tanjira krpom.

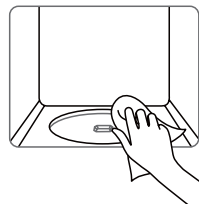

ROTIRAJUĆI TANJIR I ROTIRAJUĆI PRSTEN

Vruća voda sa sapunicom:

Prilikom vraćanja rotirajućeg tanjira u svoje udubljenje, ona mora pravilno da se pričvrsti.



PANEL VRATA

Sredstvo za čišćenje stakla:

Očistite krpom za posuđe. Nemojte koristiti strugače za staklo.

ODRŽAVANJE REŠAVANJE PROBLEMA

Potražite problem u grafikonu u nastavku i isprobajte rešenja za svaki problem.
Ako mikrotalasna rerna i dalje ne radi ispravno, obratite se najbližem ovlašćenom servisu.

PROBLEM	MOGUĆI UZROK	MOGUĆE REŠENJE
Rerna neće da se upali	<ul style="list-style-type: none">a. Električni kabl za rernu nije uključen.b. Vrata su otvorena.c. Podešena je pogrešna radna funkcija.	<ul style="list-style-type: none">a. Priključite u utičnicu.b. Zatvorite vrata i pokušajte ponovo.c. Proverite uputstva
Varničenje ili iskrenje	<ul style="list-style-type: none">a. Korišćeni su materijali koje treba izbegavati u mikrotalasnoj rerni.b. Rerna je uključena da radi dok je bila prazna.c. Prolivena hrana je ostala u unutrašnjosti.	<ul style="list-style-type: none">a. Koristite samo posuđe bezbedno za mikrotalasnu rernu.b. Nemojte uključivati rernu da radi kada je prazna.c. Očistite šupljinu mekom vlažnom krpom.
Neravnomerno kuvana hrana	<ul style="list-style-type: none">a. Korišćeni su materijali koje treba izbegavati u mikrotalasnoj rerni.b. Hrana nije potpuno odmrznuta.c. Vreme kuvanja, nivo snage nisu odgovarajući.d. Hrana se ne okreće niti meša.	<ul style="list-style-type: none">a. Koristite samo posuđe bezbedno za mikrotalasnu rernu.b. Potpuno odmrznite hranu.c. Koristite ispravno vreme kuvanja, nivo snage.d. Okrenite ili promešajte hranu.
Prekuvana hrana	Vreme kuvanja, nivo snage nisu odgovarajući.	Koristite ispravno vreme kuvanja, nivo snage.
Nedovoljno kuvana hrana	<ul style="list-style-type: none">a. Korišćeni su materijali koje treba izbegavati u mikrotalasnoj rerni.b. Hrana nije potpuno odmrznuta.c. Ventilacioni otvori rerne su blokirani.d. Vreme kuvanja, nivo snage nisu odgovarajući.	<ul style="list-style-type: none">a. Koristite samo posuđe bezbedno za mikrotalasnu rernu.b. Potpuno odmrznite hranu.c. Proverite da li otvori za ventilaciju rerne nisu blokirani.d. Koristite ispravno vreme trajanja kuvanja, nivo snage
Nepravilno odmrzavanje	<ul style="list-style-type: none">a. Korišćeni su materijali koje treba izbegavati u mikrotalasnoj rerni.b. Vreme kuvanja, nivo snage nisu odgovarajući.c. Hrana se ne okreće niti meša.	<ul style="list-style-type: none">a. Koristite samo posuđe bezbedno za mikrotalasnu rernu.b. Koristite ispravno vreme kuvanja, nivo snage.c. Okrenite ili promešajte hranu.



Prema Direktivi o otpadnoj električnoj i elektronskoj opremi (WEEE), WEEE treba odvojeno prikupljati i obrađivati. Ako u bilo kom trenutku u budućnosti budete morali da odložite ovaj proizvod, nemojte ga odlagati sa kućnim otpadom. Pošaljite ovaj proizvod na mesta za sakupljanje WEEE, gde je to dostupno.

#DetailsMatter

ИНСТРУКЦИИ ЗА УПОТРЕБА

МИКРОВЪЛНОВА ФУРНА

MW3 - AC26SF (WH)

Моля, прегледайте това ръководство с инструкции, преди да започнете работа.

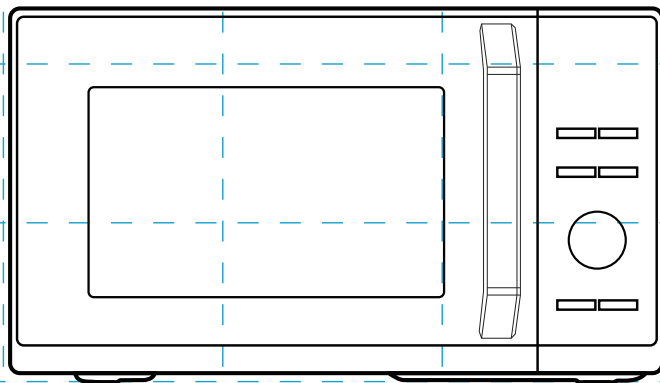

TOSHIBA

СЪДЪРЖАНИЕ

БЕЗОПАСНОСТ НА ПРОДУКТА

Предпазни мерки за избягване на възможно излагане на прекомерна микровълнова енергия	BG-01
Важни указания за безопасност	BG-03
Заземителна инсталация	BG-08
Почистване	BG-10
Съдове и прибори	BG-11
Материали, които можете да използвате в микровълновата фурна	BG-12
Материали, които не трябва да се използват в микровълнова фурна.....	BG-14

НАСТРОЙКА НА ПРОДУКТА

Настройване на вашата фурна	BG-15
-----------------------------------	-------

ИНСТРУКЦИЯ ЗА УПОТРЕБА

Преди да използвате за първи път	BG-18
Работа	BG-19
1. Нива на мощност.....	BG-20
2. Настройка на часовника.....	BG-20
3. Кухненски таймер.....	BG-21
4. Микровълново готвене	BG-22
5. Грил или комбинирано	BG-22
6. Конвекция с подгряване	BG-23
7. Конвекция без подгряване	BG-24
8. Меню пържене с горещ въздух.....	BG-25
9. Автоматично меню и меню хрупкава скара	BG-26
10. Тегло за размразяване.....	BG-28
11. Време за размразяване	BG-28
12. Готвене на няколко етапа.....	BG-29

13. Бързо готвене	BG-30
14. Функция заключване	BG-31
15. Функция за проверка	BG-31

ПОЧИСТВАНЕ И ПОДДРЪЖКА

Почистване.....	BG-32
Отстраняване на неизправности	BG-34



ЗАБЕЛЕЖКА

ПРЕДИ ДА ИЗПОЛЗВАТЕ ТОЗИ ПРОДУКТ,
ПРОЧЕТЕТЕ, РАЗБЕРЕТЕ И СЛЕДВАЙТЕ ТЕЗИ
ИНСТРУКЦИИ.
НЕ ЗАБРАВЯЙТЕ ДА ЗАПАЗИТЕ ТОЗИ НАРЪЧНИК
ЗА БЪДЕЩИ СПРАВКИ.

БЕЗОПАСНОСТ НА ПРОДУКТА

ПРЕДПАЗНИ МЕРКИ ЗА ИЗБЯГВАНЕ НА ВЪЗМОЖНО ИЗЛАГАНЕ НА ПРЕКОМЕРНА МИКРОВЪЛНОВА ЕНЕРГИЯ МИКРОВЪЛНОВА ЕНЕРГИЯ

(a). Не се опитвайте да работите с тази фурна с отворена врата, тъй като това може да доведе до вредно излагане на микровълнова енергия. Важно е да не се чупят или подправят предпазните блокировки.

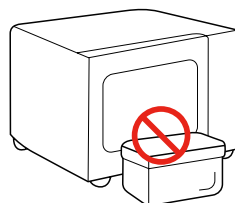

(b). Не поставяйте никакви предмети между предната страна на фурната и вратата и не позволявайте замърсяване или остатъци от почистващ препарат да се натрупат върху уплътнителните повърхности.

(c). **ПРЕДУПРЕЖДЕНИЕ:** При повреда във вратата или нейните уплътнения, фурната не трябва да се използва докато не бъдат ремонтирани от компетентно лице.

ДОПЪЛНЕНИЕ

Ако уредът не се поддържа в добро, чисто състояние, повърхността му може да се повреди и да повлияе на живота на уреда, както и да доведе до опасни ситуации.

ХАРАКТЕРИСТИКИ

МОДЕЛ	MW3 - AC26SF (WH)
НОМИНАЛНО НАПРЕЖЕНИЕ/ЧЕСТОТА	230-240 V~ 50 Hz
НОМИНАЛНА ВХОДНА МОЩНОСТ (МИКРОВЪЛНИ)	1450 W
НОМИНАЛНА ИЗХОДНА МОЩНОСТ (МИКРОВЪЛНОВА)	900 W
НОМИНАЛНА ВХОДНА МОЩНОСТ (ГРИЛ)	1000 W
НОМИНАЛНА ВХОДНА МОЩНОСТ(КОНВЕКЦИЯ)	2100 W



ЗАБЕЛЕЖКА

Всички снимки в това ръководство са само с илюстративна цел; те може да се различават от закупеното оборудване, моля, вижте действителния продукт.

ВАЖНИ УКАЗАНИЯ ЗА БЕЗОПАСНОСТ



ПРЕДУПРЕЖДЕНИЕ

За да намалите риска от пожар, токов удар, нараняване на хора или излагане на прекомерна енергия от микровълновата фурна, когато използвате вашия уред, следвайте основните предпазни мерки, включително следното:



Прочетете и следвайте конкретните мерки:
„ПРЕДПАЗНИ МЕРКИ ЗА ИЗБЯГВАНЕ НА ВЪЗМОЖНО ИЗЛАГАНЕ НА ПРЕКОМЕРНА МИКРОВЪЛНОВА ЕНЕРГИЯ“.



Този уред може да се използва от деца над 8 години и лица с намалени физически, сензорни или умствени способности или от такива, които нямат знания и опит, ако са под наблюдение или са им дадени инструкции относно използването на уреда по безопасен начин и разбират съществуващите опасности. Децата не трябва да играят с уреда.



поддръжката не трябва да се извършват от деца без наблюдение.



Пазете уреда и неговия кабел далеч от деца, които са по-малки от 8 години.



Ако захранващият кабел бъде повреден, той трябва да бъде сменен от производителя, негов сервизен агент или от лица с подобна квалификация, за да бъде избегната евентуална опасност.



ПРЕДУПРЕЖДЕНИЕ:
Уверете се, че уредът е изключен, преди да смените лампата, за да избегнете опасността от токов удар.

ВАЖНИ УКАЗАНИЯ ЗА БЕЗОПАСНОСТ



ПРЕДУПРЕЖДЕНИЕ:

Опасно е за всеки, освен компетентните лица, да извършва сервиз или ремонт, който включва отстраняване на капака, предоставящ защита срещу излагане на микровълнова енергия.



ПРЕДУПРЕЖДЕНИЕ:

Течностите и другите храни не трябва да се подгръват в запечатани контейнери, тъй като е възможно да експлодират.



Когато подгръвате храна в пластмасови или хартиени контейнери, наблюдавайте фурната поради риск от запалване.

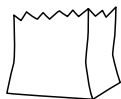

Използвайте само домакински съдове и прибори, които са подходящи за използване в микровълнови фурни.



Ако излиза дим, изключете уреда, извадете щепсела и дръжте вратата затворена, за да задушите пламъците.



Микровълновото нагряване на напитки може да доведе до закъсняло бурно кипене и следователно е необходимо да сте внимателни при боравене с контейнера.





Съдържанието на бибероните и бурканчетата с бебешки храни трябва да се разбърква или разклаща, а температурата да се проверява преди консумация, за да се избегнат изгаряния.

ВАЖНИ УКАЗАНИЯ ЗА БЕЗОПАСНОСТ

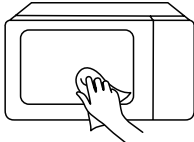
 Фурната трябва да се почиства редовно, а остатъците от храна да се отстраняват. Моля, поддържайте зоната на вълновода чиста. Използвайте мека влажна кърпа, за да я почистите, когато има остатъци от пръски храна върху вълноводната област или затвореното отделение. Непочистените остатъци от храна може да причинят безобидни искри или дим в микровълновата фурна, може да се появи и промяна в цвета на затвореното отделение.



 Неподдържането на фурната в чисто състояние може да доведе до влошаване на състоянието на повърхностите и да повлияе неблагоприятно върху експлоатационния живот на уреда и евентуално да доведе до опасна ситуация.

 Използвайте само температурен сензор, препоръчан за тази фурна. (за фурни, снабдени с възможност за използване на температурна сензорна сонда.)

 Микровълновата фурна трябва да работи с отворена декоративна врата. (за фурни с декоративна врата.)

 Този уред е предназначен да се използва в домакинства и други подобни, като:

1. кухни за персонала в магазини, офиси и други работни среди;
2. от клиенти в хотели, мотели и други жилищни сгради;
3. селски къщи;
4. в заведения, предлагащи легло и закуска.

ВАЖНИ УКАЗАНИЯ ЗА БЕЗОПАСНОСТ

 Микровълновата фурна е предназначена за подгръване на храни и напитки. Изсушаването на храни или дрехи и подгръването на затоплящи подложки, чехли, гъби, влажни дрехи и други подобни, може да доведе до риск от нараняване, запалване или пожар.

 Уредът е предназначен да се използва самостоятелно.

 Задната повърхност на уредите трябва да бъде поставена срещу стена.

 Температурата на достъпните повърхности може да бъде висока по време на работа на уреда.

 **ПРЕДУПРЕЖДЕНИЕ:** Когато уредът работи в комбиниран режим, децата могат да



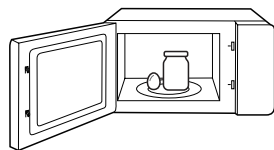

използват фурната само под наблюдение на възрастни поради генерираната висока температура.

 Яйцата с черупки не трябва да се подгръват в микровълнови фурни, тъй като могат да експлодират, дори след приключване на нагръването с микровълни.



 Уредът не трябва да се монтира зад декоративна врата, за да се избегне прегряване. (Това не е приложимо за уреди с декоративна врата.)

ВАЖНИ УКАЗАНИЯ ЗА БЕЗОПАСНОСТ

-  Микровълновата фурна не трябва да се поставя в шкаф, освен ако не е тествана в шкаф.
-  По време на готвене в микровълновата фурна не се допуска използването на метални съдове за храна и напитки.
-  Уредът не трябва да се почиства с парочистачка.
-  Уредите не са предназначени да се управляват с помощта на външен таймер или отделна система за дистанционно управление.

ПРОЧЕТЕТЕ ВНИМАТЕЛНО И
ЗАПАЗЕТЕ ЗА БЪДЕЩИ СПРАВКИ

ЗАЗЕМЯВАНЕ НА ИНСТАЛАЦИЯТА С ЦЕЛ НАМАЛЯВАНЕ НА РИСКА ОТ НАРАНЯВАНЕ

Уредът трябва да бъде заземен. В случай на късо съединение заземяването намалява риска от токов удар, осигурявайки безопасен проводник за утечка на тока.

Този уред разполага със заземителен кабел и щепсел. Щепселът следва да бъде включен в контакт, който е надлежно монтиран и заземен.

ПРЕДУПРЕЖДЕНИЕ – Неправилното заземяване може да доведе до опасност от токов удар. В случай че изпитвате съмнения дали уредът е заземен надлежно или не сте разбрали указанията напълно, моля посъветвайте се с квалифициран електротехник. Ако се налага да използвате удължител, е необходимо същият да бъде трижилен.



ОПАСНОСТ

Опасност от токов удар:

При докосване на вътрешните компоненти могат да възникнат сериозни наранявания или смърт. Не разглобявайте този уред.

ЗАЗЕМЯВАНЕ НА ИНСТАЛАЦИЯТА С ЦЕЛ НАМАЛЯВАНЕ НА РИСКА ОТ НАРАНЯВАНЕ



**ПРЕДУПРЕ-
ЖДЕНИЕ**

Опасност от токов удар:

Неправилното заземяване може да причини токов удар. Не включвайте в електрически контакт преди уредът да бъде надлежно монтиран и заземен.

1. Предоставен е къс захранващ кабел, с цел намаляване възможността от заплитане или настъпване.
2. При употреба на дълъг захранващ кабел е необходимо:
 - (1). Електрическите характеристики, посочени върху маркировката на кабела или удължителя трябва да бъдат поне равни или по-големи тези на табелката на уреда.
 - (2). Удължителният кабел трябва да бъде трижилен със заземяване.
 - (3). По-дългият кабел трябва да бъде разположен по такъв начин, че да не виси над плота или масата, където може да бъде непреднамерено дръпнат или съборен.

ПОЧИСТВАНЕ

Уверете се, че уредът е изключен от електрическата мрежа.

1. След употреба почистете вътрешната част на фурната с леко навлажнена кърпа.
2. Почистете аксесоарите по общоприетия начин със сапунена вода.
3. Рамката на вратата, уплътненията и съседните части трябва да бъдат почиствани внимателно с навлажнена кърпа.
4. Не използвайте абразивни препарати или остри метални стъргалки за почистване на стъклото на вратата, тъй като повърхността му може да бъде надраскана и впоследствие спукана.
5. Съвет: За по-лесно почистване на вътрешните повърхности: Поставете половин лимон в купа, добавете 300 ml вода и загрейте на 100% микровълнова мощност за 10 минути. Избършете фурната с мека и суха кърпа.

СЪДОВЕ



ВНИМАНИЕ

Опасност от нараняване:

Изпълняването на каквито и да било ремонтни дейности, включващи свалянето на предпазния капак за микровълни от лице, което не е компетентно за последните е опасно. Вж.

указанията в **"Материали, които могат да бъдат използвани при микровълново готвене"** или **"Материали, които не могат да бъдат използвани при микровълново готвене"**

Възможно е да има определени съдове, които не са от метал, но въпреки това са опасни за използване при микровълново готвене. В случай че изпитвате съмнения, можете да изпитате въпросния съд, като изпълните указанията по-долу.

Изпитване на съдове:

1. Напълнете съд, подходящ за микровълнова фурна, с ок. 250 ml студена вода. Поставете го във фурната заедно със съда, който искате да изпитате.
2. Включете фурната на максимална мощност за 1 минута.
3. Внимателно докоснете съда. Ако празният съд е топъл, не го използвайте за микровълново готвене.
4. Не превишавайте времетраене от 1 минута.

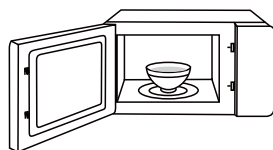

ЗАБЕЛЕЖКА

ПОДДЪРЖАЙТЕ ВЪТРЕШНИТЕ ПОВЪРХНОСТИ И ВЪЛНОВОДА ВИНАГИ ЧИСТИ

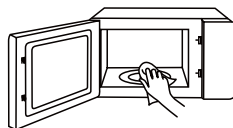

МАТЕРИАЛИ, КОИТО МОГАТ ДА БЪДАТ ИЗПОЛЗВАНИ ПРИ МИКРОВЪЛНОВО ГОТВЕНЕ

СЪДОВЕ

ЗАБЕЛЕЖКИ



Гювече

Спазвайте указанията на производителя. Дъното на съда за запичане трябва да бъде на поне 5 mm над въртящата чиния. При неправилна употреба, въртящата чиния може да се счупи.



Домакински съдове

Единствено такива, които са подходящи за микровълнова фурна. Спазвайте указанията на производителя. Не използвайте надраскани или напукани съдове.



Съклени буркани

Винаги сваляйте капака. Използвайте единствено за леко затопляне на храна. Повечето съклени буркани не са топлоустойчиви и е възможно да се счупят.



Съклени съдове

Можете да използвате единствено топлоустойчиви съклени съдове, подходящи за фурна. Уверете се, че нямат метален кант. Не използвайте надраскани или напукани съдове.



Торбички за готвене на фурна

Спазвайте указанията на производителя. Не затваряйте с метални закопчалки. Направете прорези, така че парата да може да излиза.



Картонени чинии и чаши

Използвайте единствено при готвене с кратко времетраене или затопляне на храна. По време на готвене не оставяйте фурната без наблюдение.



Хартиени кърпи

Служи за покриване на храната при затопляне и поглъщане на мазнина. Да се използва винаги под наблюдение, единствено при готвене с кратко времетраене.



Пергаментова хартия

Може да бъде използвано като покривало за предотвратяване на пръски или обвивка за задушаване на храната.



МАТЕРИАЛИ, КОИТО МОГАТ ДА БЪДАТ ИЗПОЛЗВАНИ ПРИ МИКРОВЪЛНОВО ГОТВЕНЕ

СЪДОВЕ

ЗАБЕЛЕЖКИ



Пластмаса

Единствено такива, които са подходящи за микровълнова фурна. Спазвайте указанията на производителя. Необходимо е да има етикет, указващ пригодност за употреба в микровълнова фурна. Някои съдове от пластмаса омекват, когато храната в тях се нагоречи. Готварските торби и плътно затворените полиетиленови торбички трябва да бъдат разрязани, пробити или вентилирани, съгласно указанията на опаковката.



Полиетиленово фолио

Единствено такива, които са подходящи за микровълнова фурна. Покрийте храната, за да задържите влагата в нея. Внимавайте полиетиленово фолио да не се докосва до храната.



Термометри

Единствено такива, които са подходящи за микровълнова фурна (термометри за месо и сладкиши)



Восъчна хартия

Покрийте храната, за да предотвратите пръски по стените и да задържите влагата в нея.



МАТЕРИАЛИ, КОИТО НЕ МОГАТ ДА БЪДАТ ИЗПОЛЗВАНИ ПРИ МИКРОВЪЛНОВО ГОТВЕНЕ

СЪДОВЕ

ЗАБЕЛЕЖКИ



Алуминиева тава

Може да причини образуване на дъга. Прехвърлете храната в съд, подходящ за микровълнова фурна.



Картонена опаковка за храна с метална дръжка

Може да причини образуване на дъга. Прехвърлете храната в съд, подходящ за микровълнова фурна.



Съдове от метал или с метален кант

Металът предпазва храната от микровълновата енергия. Металните кантове могат да причинят образуване на дъга.

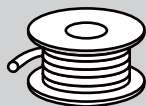

Метални закопчалки

Могат да причинят образуване на дъга или пожар.



Хартиени пликове

Могат да се запалят във фурната.



Пореста пластмаса

При излагане на висока температура порестата пластмаса може да се разтопи или да замърси храната, поставена в нея.



Дърво

Ако бъде използвано в микровълнова фурна, дървото може да се напука или разцепи.



НАСТРОЙКА НА ПРОДУКТА

НАСТРОЙВАНЕ НА ВАШАТА ФУРНА

(В случай на разлики между уреда и снимките в това ръководство, продуктът има предимство.)

ИМЕНА НА ЧАСТИТЕ И АКСЕСОАРИТЕ НА ФУРНАТА

Извадете фурната и всички материали от кашона и затвореното отделение на фурната.

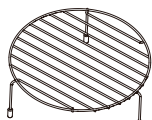

Високагрил решетка

Решетка за скара (не може да се използва в микровълнова фурна и трябва да се постави върху стъкления поднос)

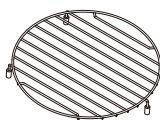

Ниска скара за грил

Решетка за скара (не може да се използва в микровълнова фурна и трябва да се постави върху стъкления поднос)

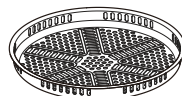

Тава за печене (Не може да се използва заедно с функцията за микровълнова фурна и може да се постави на скарата за грил)



Стъклен поднос

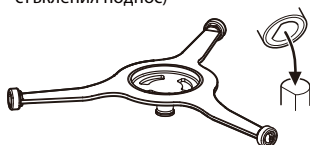

Монтаж на въртящия се пръстен



Инструкции за употреба

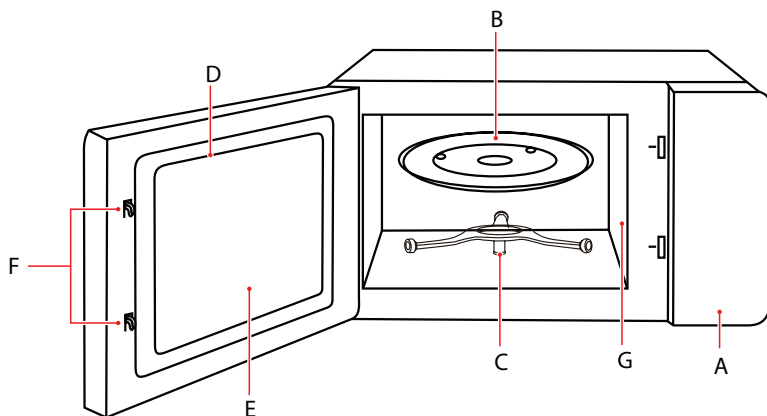

A) Панел за управление

B) Стъклен поднос

C) Монтаж на въртящия се пръстен

D) Монтаж на вратата

E) Прозорец за наблюдение

F) Система за безопасно заключване

G) Капак на вълновода

НАСТРОЙВАНЕ НА ВАШАТА ФУРНА

МОНТАЖ НА ВЪРТЯЩАТА СЕ ПОДЛОЖКА

Почистете отделението за готвене и поставете въртящата се подложка.

При нови инсталации се уверете, че всички опаковъчни и транспортни ленти са премахнати от вала на въртящата се подложка.

Преди да използвате уреда за приготвяне на храна за първи път, ще трябва да поставите правилно въртящата се подложка. Трябва да почистите отделението за готвене и аксесоарите. Можете също да ги насочите към раздела за почистване.

Как да поставите въртящата се подложка на място:

1. Поставете въртящия се пръстен ② във вдлъбнатината в отделението за готвене.
2. Поставете стъклената подложка ① на въртящия се пръстен ②.

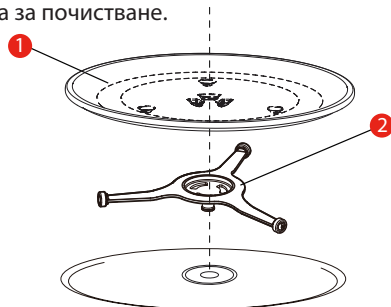

1) Стъклен поднос

2) Монтаж на въртящия се пръстен

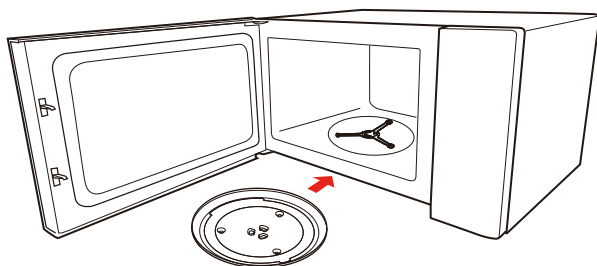

ЗАБЕЛЕЖКА

- Никога не използвайте уреда без въртяща се подложка. Уверете се, че е поставена правилно. Въртящата се подложка може да се върти по часовниковата стрелка или обратно.
- Никога не поставяйте стъклената подложка обратно. Стъклената подложка никога не трябва да бъде ограничавана.
- Стъклената подложка и въртящия се пръстен трябва винаги да се използват по време на готвене.
- Всички хранителни продукти и контейнери с продукти трябва винаги да се поставят върху стъклената подложка.
- Никога не ограничавайте движението на въртящата се подложка.
- Ако стъклената подложка или въртящия се пръстен се напукат или счупят, се свържете с най-близкия упълномощен сервизен център.

ИНСТАЛИРАНЕ ВЪРХУ ПЛОТ

Отстранете всички опаковъчни материали и приспособления. Проверете фурната за повреди, като вдлъбнатини или счупена врата. Не включвайте фурната, ако е повредена.
Шкаф: Отстранете защитното фолио от повърхността на шкафа за микровълновата фурна. Не сваляйте капака на вълновода, прикрепен към затвореното отделение на фурната за предпазване на магнетрона.

МОНТАЖ

- Изберете хоризонтална повърхност, която осигурява достатъчно пространство за фурната и отворите за входящ и изходящ въздух.
 - Минималната височина за монтаж е 85 см.
 - Задната повърхност на уреда трябва да бъде поставена срещу стена. Оставете минимално разстояние от 30 см над фурната. Изисква се минимално разстояние от 20 см между фурната и всички съседни стени.
 - Не отстранявайте краката от долната страна на фурната.
 - Ако отворите за входящ и изходящ въздух са блокирани, фурната може да се повреди.
 - Разположете фурната възможно най-далеч от радио и телевизионни приемници. Когато микровълновата фурна работи, може да предизвика смущения в радио и телевизионния сигнал.

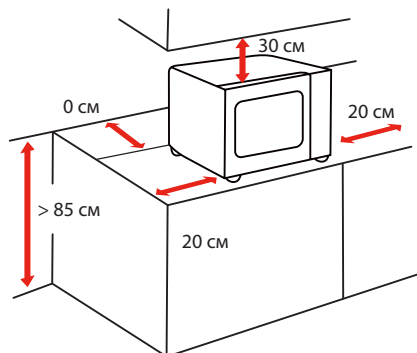

- Включете фурната в стандартен домакински контакт. Уверете се, че напрежението и честотата съвпадат с посочените на табелата на уреда.



ЗАБЕЛЕЖКА

- Не монтирайте фурната над котлони или други генериращи топлина уреди. Ако бъде монтирана в близост до или над източник на топлина, фурната може да се повреди, което ще анулира гаранцията.

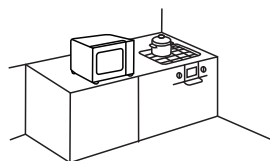

Възможно е достъпните повърхности да се нагреят по време на работа

ИНСТРУКЦИЯ ЗА УПОТРЕБА

ПРЕДИ ДА ИЗПОЛЗВАТЕ ЗА ПЪРВИ ПЪТ

Нормално е фурната да произвежда неприятни миризми, когато се използва за първи път.

Този раздел ви казва какво трябва да направите, преди да използвате микровълновата фурна, за да пригответе храна за първи път. Прочетете предварително раздела, озаглавен „**ЕЗОПАСНОСТ НА ПРОДУКТА**“.

Преди да можете да използвате новия си уред, ще трябва да поставите подложката правилно на мястото . Трябва да почистите отделението за готвене и аксесоарите.



ЗАБЕЛЕЖКА

- Никога не използвайте уреда без въртяща се подложка.
- Уверете се, че е правилно включен. Подложката може да се върти по посока на часовниковата стрелка или обратно на часовниковата стрелка.

РАБОТА

КОНТРОЛЕН ПАНЕЛ И ФУНКЦИИ

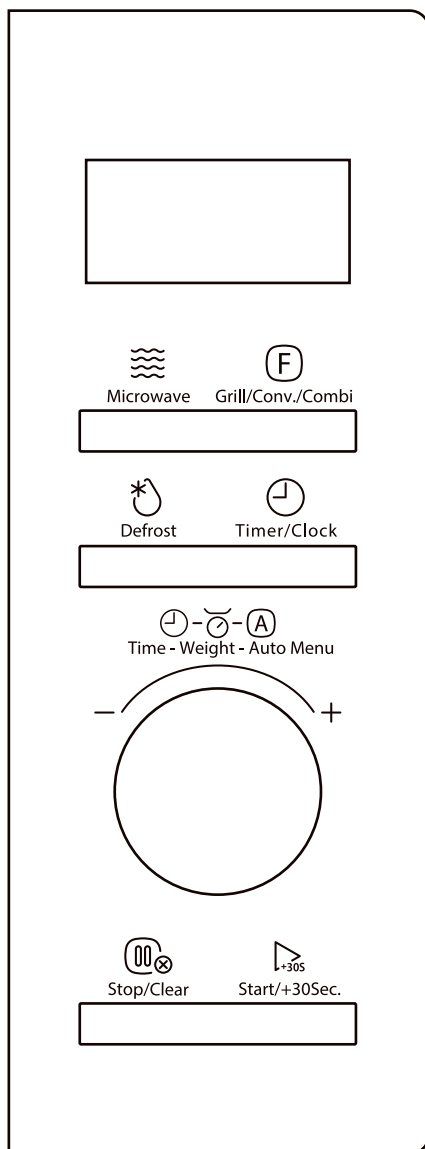



1. НИВА НА МОЩНОСТ



Има 5 нива на мощност.

НИВО	МОЩНОСТ	ДИСПЛЕЙ
1	100%	P100
2	80%	P80
3	50%	P50
4	30%	P30
5	10%	P10

2. НАСТРОЙКА НА ЧАСОВНИКА

Когато микровълновата фурна е включена в контакт, ще се покаже „0:00“.

- a**  Натиснете **Timer/Clock** два пъти, показва се 00:00.
- b** Завъртете копчето, за да настроите часа, въведеното число трябва да бъде в диапазона 0-23.
- c**   Натиснете **Start/+30Sec.** или **Timer/Clock**, за да потвърдите стойностите на часовете.
- d** Завъртете копчето, за да зададете минутите, въведеното число трябва да бъде в диапазона 0-59.

e Натиснете  или,  за да потвърдите.



ЗАБЕЛЕЖКА

- Когато фурната е включена, ако часовникът не е настроен, тя няма да работи.
- В процеса на настройка на часовника, ако не се извършва никаква операция в рамките на 5 минути или натиснете  директно, дисплеят автоматично ще се върне към предишната настройка на часовника.

3. КУХНЕНСКИ ТАЙМЕР

Когато микровълновата фурна е включена в контакт, ще се покаже „0:00“.

a Натиснете  веднъж



b Завъртете копчето, за да зададете часа, той трябва да бъде в рамките на 0:05-95:00.

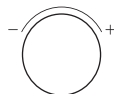

c Натиснете , за да стартирате таймера.





ЗАБЕЛЕЖКА

- Настройката на кухненския таймер е различна от настройката на часовника; това е просто таймер.
- По време на функцията Кухненски таймер не може да бъде зададена функция за готвене.

4. МИКРОВОЛНОВО ГОТВЕНЕ

Когато микровълновата фурна е включена в контакт, ще се покаже „0:00“.

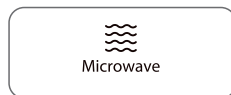
Натиснете  Microwave повече пъти, за да изберете нивото на мощност.



a или

Натиснете  Microwave веднъж и завъртете бутона, за да зададете нивото на мощност.



b Натиснете  Start/+30Sec. , за да потвърдите нивото на мощност.



c Завъртете копчето, за да зададете часа, максималната стойност на времето е „95:00“.



d Натиснете  Start/+30Sec. , за да стартирате готвене.



5. ГРИЛ ИЛИ КОМБИНИРАНО

Натиснете  Grill/Conv./Combi повече пъти, за да изберете режима.



a или

Натиснете  Grill/Conv./Combi веднъж и след това завъртете копчето, за да изберете режима.





По ред ще се покажат „G-1, C-1...C-4, 150°C, 160°C.....240°C“. (G-1 е грил, C-1~C-4 са комбинация).

b Натиснете  Start/+30Sec., за да потвърдите режима.

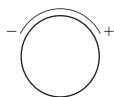

c Завъртете копчето, за да зададете часа, максималната стойност на времето е „95:00“.



d Натиснете  Start/+30Sec., за да стартирате готвене.



ЗАБЕЛЕЖКА

• Във функция грил, когато измине половината от зададеното време, се включва звуков сигнал, който напомня да обърнете хранителния продукт. Ако не извършите тази операция, фурната ще продължи да работи.

6. КОНВЕКЦИЯ С ПОДГРЯВАНЕ

a Натиснете  Grill/Conv./Combi още пъти, за да изберете температурата на конвекция.



или

Натиснете  Grill/Conv./Combi веднъж и след това завъртете копчето, за да изберете температурата на конвекция. Налични са 150°C, 160°C240°C.



b Натиснете  Start/+30Sec., за да стартирате подгряване. Когато подгряването приключи, температурата ще премигне, отворете вратата и поставете храната във фурната.



c Завъртете копчето, за да зададете часа, максималната стойност на времето е „95:00“.

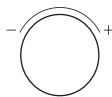

d Натиснете  Start/+30Sec. , за да стартирате готвене.



7. КОНВЕКЦИЯ БЕЗ ПОДГРЯВАНЕ

f Натиснете  още пъти, за да изберете температурата на конвекция.



a или

f Натиснете  веднъж и след това завъртете копчето, за да изберете температурата на конвекция. Налични са 150°C, 160°C240°C.



b Натиснете  Start/+30Sec. , за да потвърдите температурата.



c Завъртете копчето, за да зададете часа, максималната стойност на времето е „95:00“.

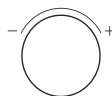



d Натиснете  Start/+30Sec. , за да стартирате готвене.

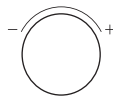

8. МЕНЮ ПЪРЖЕНЕ С ГОРЕЩ ВЪЗДУХ

- a** В състояние на изчакване завъртете бутона надясно, за да влезете във функцията на менюто.
Завъртете бутона многократно, за да изберете тип меню Н-1.



- b** Натиснете  Start/+30Sec. , за да потвърдите типа на менюто



- c** Завъртете въртящия бутон, за да изберете подменю.

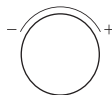

- d** Натиснете  Start/+30Sec. , за да стартирате готвене.



ТАБЛИЦА НА МЕНЮТО ПЪРЖЕНЕ С ГОРЕЩ ВЪЗДУХ

ДИСПЛЕЙ	МЕНЮ	ТЕГЛО
Н-1	Замразени пържени картофи	300 г
Н-2	Крокети от замразени картофи	350 г
Н-3	Замразени калмари	250 г
Н-4	Замразени лучени кръгчета	250 г
Н-5	Замразени пилешки хапки	350 г
Н-6	Шницел	400 г
Н-7	Скариди	250 г
Н-8	Зеленчуци	200 г
Н-9	Пролетни рулца	300 г

Забележка: Теглото на менюто за пържене с горещ въздух не може да бъде зададено.

9. АВТОМАТИЧНО МЕНЮ И МЕНЮ ХРУПКАВА СКАРА

- a** В състояние на изчакване завъртете бутона надясно, за да влезете във функцията на менюто.

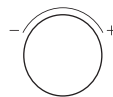

Завъртете бутона многократно, за да изберете меню Auto (дисплей A-1) или меню Crispy Grill (дисплей C-1). Например, изберете C-1.

- b** Натиснете  за потвърждение.



- c** Завъртете бутона, за да изберете подменюто, налични са C-1~C-4.



- d** Натиснете  за потвърждение.
Завъртете въртящия бутон, за да зададете теглото



Теглото на C-3 и C-4 не може да бъде зададено.

- e** Натиснете  за потвърждение.



ТАБЛИЦА НА МЕНЮТО ЗА ХРУПКАВА СКАРА

ДИСПЛЕЙ	МЕНЮ	ТЕГЛО
C-1	Кордон бльо	300 г
		600 г
		900 г
C-2	лазаня	200 г
		300 г
		400 г
		500 г
C-3	хляб	100 г
C-4	пай/тарт	8 (около 350 г)

ТАБЛИЦА С АВТОМАТИЧНО МЕНЮ

МЕНЮ	ДИСПЛЕЙ	ТЕГЛО/ КОЛИЧЕСТВО	НИВО НА МОЩНОСТ
A-1 АВТОМАТИЧНО ПРЕТОПЛЯНЕ	150 г	150 г	P100
	250 г	250 г	
	350 г	350 г	
	450 г	450 г	
	600 г	600 г	
A-2 КАРТОФИ	1	1 (230 г)	P100
	2	2	
	3	3	
A-3 МЕСО	150 г	150 г	P80
	300 г	300 г	
	450 г	450 г	
	600 г	600 г	
A-4 ЗЕЛЕНЧУЦИ	150 г	150 г	P100
	350 г	350 г	
	500 г	500 г	
A-5 РИБА	150 г	150 г	P80
	250 г	250 г	
	350 г	350 г	
	450 г	450 г	
	650 г	650 г	
A-6 МАКАРОНЕНИ ИЗДЕЛИЯ	50 г (със студена вода 450 г)	50 г	P80
	100 г (със студена вода 800 г)	100 г	
	150 г (със студена вода 1200 г)	150 г	
A-7 СУПА	200 г	200 г	P100
	400 г	400 г	
	600 г	600 г	
A-8 ТОРТА	475 г	475 г	CONVEC.160°C (С подгръване 160°C)
A-9 ПИЦА	100 г	100 г	C-4
	200 г	200 г	
	300 г	300 г	
A10 ПИЛЕ	500 г	500 г	C-4
	750 г	750 г	
	1000 г	1000 г	
	1200 г	1200 г	

10. ТЕГЛО ЗА РАЗМРАЗЯВАНЕ

- a** Натиснете  Defrost веднъж, ще се покаже „dEF1“.



- b** Завъртете копчето, за да зададете теглото на храната, то трябва да бъде в рамките на „100 г - 2000 г“.

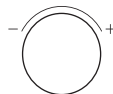

- c** Натиснете  Start/+30Sec., за да стартирате размразяване.



ЗАБЕЛЕЖКА

- По време на размразяването ще се чуе двукратен звуков сигнал, който напомня да обърнете хранителния продукт.

11. ВРЕМЕ ЗА РАЗМРАЗЯВАНЕ

- a** Натиснете  Defrost два пъти, ще се покаже „dEF2“.

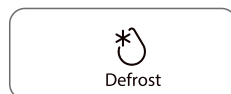

- b** Завъртете въртящия бутон, за да зададете времето, максималната стойност за време е 95:00.

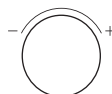

- c** Натиснете  Start/+30Sec., за да стартирате размразяване.



ЗАБЕЛЕЖКА

- Когато половината време изтече, ще се чуе двукратен звуков сигнал, за да ви напомни да обърнете храната.
- Нивото на мощност по подразбиране е P30, не може да се променя.

12. ГОТВЕНЕ НА НЯКОЛКО ЕТАПА

- a** Натиснете  Defrost два пъти, ще се покаже „dEF2“.



- b** Завъртете копчето, за да зададете часа, максималната стойност на времето е „95:00“.



- c** Натиснете  Grill/Conv./Combi, за да изберете режима на готвене.



- d** Натиснете  Start/+30Sec. за потвърждение.



- e** Завъртете копчето, за да зададете часа, максималната стойност на времето е „95:00“.

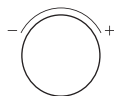

- f** Натиснете  Start/+30Sec. , за да стартирате готвене.



ЗАБЕЛЕЖКА

- В режим за готвене на етапи могат да бъдат зададени два етапа.
- Ако зададете функция за размразяване, тя автоматично се превръща в първи етап на готвене.
- При готвене на няколко етапа не може да бъде зададен таймер, автоматично меню, скоростно готвене и претопляне.

13. БЪРЗО ГОТВЕНЕ

- a** Завъртете копчето наляво веднъж, за да изберете режима на готвене със 100% ниво на мощност за 5 секунди директно.

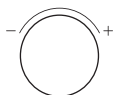

- b** Завъртете въртящия бутон, за да зададете времето, максималната стойност за време е 95:00.

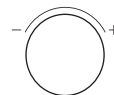

- c** Натиснете  Start/+30Sec. , за да стартирате готвене.



- a** Натиснете  Start/+30Sec. веднъж, за да готвите със 100% ниво на мощност 30 секунди директно.



14. ФУНКЦИЯ ЗАКЛЮЧВАНЕ

- a** За да заключите микровълновата фурна, така че да не може да се използва от деца или други непреднамерени потребители, натиснете подложката  за 3 секунди, ще се покаже заключената икона.



- b** За да отключите, натиснете подложката  за 3 секунди.



15. ФУНКЦИЯ ЗА ПРОВЕРКА

- a** Когато фурната готви, натиснете  Timer/Clock, текущото време ще се появи за три секунди на дисплея.



ПОЧИСТВАНЕ И ПРОФИЛАКТИКА

ПОЧИСТВАНЕ

При полагане на необходимите грижи и надлежно почистване, този уред ще запази добрия си външен вид и ще остане напълно функционален за дълго. По-долу ще Ви обясним как да правите това.



ПРЕДУПРЕЖДЕНИЕ

- Евентуално надраскване на стъклото на вратата може да се превърне в пукнатина. При почистване не използвайте стъргалки или други остри предмети, както и агресивни препарати с абразивно действие.
- При неправилно почистване покритието на уреда може да бъде повредено. Това би довело до изпускане на микровълново лъчение. Почиствайте уреда редовно и премахвайте незабавно всякакъв вид разсипана храна.
- Не потапяйте уреда във вода и не го почиствайте с водна струя.

Препарати за почистване

За да избегнете амортизиране на повърхностите вследствие използването на неподходящи препарати, моля запознайте се с информацията по-долу. Измивайте добре новите домакински гъби или кърпи, преди да ги използвате.

Не използвайте:



Агресивни почистващи препарати с абразивно действие



Стъргалки за метал или стъкло, за почистване на панелите на вратата

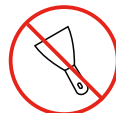

Стъргалки за метал или стъкло, за почистване на уплътненията на вратата



Домакинска тел и твърди кухненски гъби



Почистващи препарати с високо съдържание на алкохол

ПРЕДНА ЧАСТ

Гореща сапунена вода:

Почистете като избършете първо с влажна, а след това с мека суха кърпа. При почистване не използвайте стъргалки.

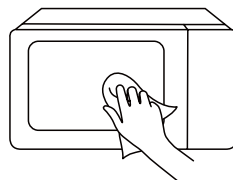

ПРЕДНА ПЛОЧА

Гореща сапунена вода:

Почистете като избършете първо с влажна, а след това с мека суха кърпа.

Отстранявайте незабавно пръски и петна от варовик, мазнина, нишесте и албумин. Тяхното натрупване може да доведе до образуване на корозия. При почистване не използвайте препарати за почистване на стъкло или стъргалки.

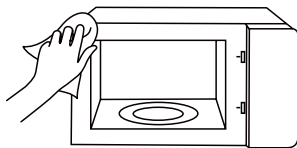

ВЪТРЕШНОСТ

Гореща сапунена вода или оцетов разтвор:

Почистете като избършете първо с влажна, а след това с мека суха кърпа. Не използвайте препарати за почистване на фурна или други агресивни субстанции с абразивно действие. Освен това, тампони за почистване от метал, груби домакински гъбички и домакинска тел също са неподходящи за почистване на фурната. Те биха надраскали повърхността. Изчакайте, докато вътрешните повърхности изсъхнат напълно.

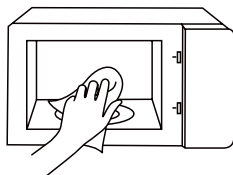

ГНЕЗДО ЗА РАЗПОЛАГАНЕ НА ВЪРТЯЩАТА ЧИНИЯ

Навлажнена кърпа:

Не допускате проникването на вода в уреда посредством задвижващия механизъм на въртящата чиния. Подсушавайте задвижващия механизъм с кърпа.

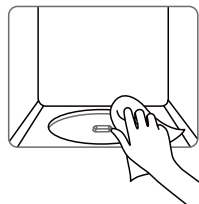

ВЪРТЯЩА ЧИНИЯ И ВОДЕЩА РОЛКА

Гореща сапунена вода:

При поставяне на въртящата чиния се уверете, че е захваната надлежно в гнездото.

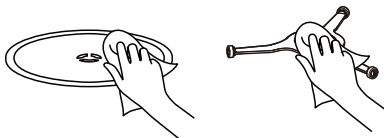

ВРАТА

Препарат за стъкло:

Почиствайте с кърпа за съдове. Не използвайте стъргалки за стъкло.

ОТСТРАНЯВАНЕ НА НЕИЗПРАВНОСТИ

Опитайте решенията за всеки проблем, след като използвате таблицата по-долу, за да проверите проблема си. Свържете се с най-близкия оторизиран сервиз, ако микровълновата фурна все още не функционира правилно.

ПРОБЛЕМ	ВЕРОЯТНА ПРИЧИНА	ВЪЗМОЖНО РЕШЕНИЕ
Фурната не се стартира	<ul style="list-style-type: none">a. Електрическият кабел на фурната не е включен в контакта.b. Вратата е отворена.v. Избрана е неправилна операция.	<ul style="list-style-type: none">a. Свържете към контакта.b. Заклучете вратата и опитайте още веднъж.v. Проверете указанията
Зарязване или искрене	<ul style="list-style-type: none">a. Използвани са предмети, които не трябва да се използват в микровълнова фурна.b. Фурната е използвана, когато е празна.v. Храната, която се е разляла, остава в кухнята.	<ul style="list-style-type: none">a. Използвайте само съдове за готвене, които са безопасни за микровълнова фурна.b. Никога не използвайте фурна, която е празна.v. Почистете кухнята с влажна кърпа.
Неравномерно сготвени храни	<ul style="list-style-type: none">a. Използвани са предмети, които не трябва да се използват в микровълнова фурна.b. Храната не се е размразила напълно.v. Нивото на мощност е недостатъчно за времето за готвене.г. Ястието не е обърнато или разбъркано.	<ul style="list-style-type: none">a. Използвайте само съдове за готвене, подходящи за микровълнова фурнаb. Размразявайте напълно храната.v. Използвайте подходящата мощност и време за готвене.г. Разбърквайте или обръщайте храната.
Прекалено сготвени храни	Времето за готвене и нивото на мощност са недостатъчни.	Използвайте подходящата мощност и време за готвене.
Недостатъчно сготвени храни	<ul style="list-style-type: none">a. Използвани са предмети, които не трябва да се използват в микровълнова фурна.b. Храната не се е размразила напълно.v. Вентилационните отвори във фурната са ограничени.г. Времето за готвене и нивото на мощност са неподходящи.	<ul style="list-style-type: none">a. Използвайте само съдове за готвене, които са подходящи за микровълнова фурна.b. Размразете напълно храната.v. Проверете дали вентилационните отвори на фурната не са блокирани.г. Използвайте правилното време за готвене и ниво на мощност.
Неправилно размразяване	<ul style="list-style-type: none">a. Използвани са предмети, които не трябва да се използват в микровълнова фурна.b. Неподходящо ниво на мощност и време за готвене.v. Не е извършено обръщане или почистване на храната.	<ul style="list-style-type: none">a. Използвайте само съдове за готвене, подходящи за микровълнова фурна.b. използвайте препоръчаното време за готвене и ниво на мощност.v. Разбъркайте или обърнете храната.



Съгласно Директивата за отпадъците от електрическо и електронно оборудване (ОЕЕО), ОЕЕО трябва да се събират и изхвърлят отделно. Ако в бъдеще ви се наложи да изхвърлите този продукт, моля, не го изхвърляйте заедно с битовите си отпадъци. Моля, занесете този продукт в пункт за събиране на ОЕЕО, където има такъв.

#DetailsMatter

KORISNIČKI PRIRUČNIK

MIKROVALNA PEĆNICA

MW3-AC26SF(WH)

Prije uporabe pročitajte ovaj priručnik s uputama.

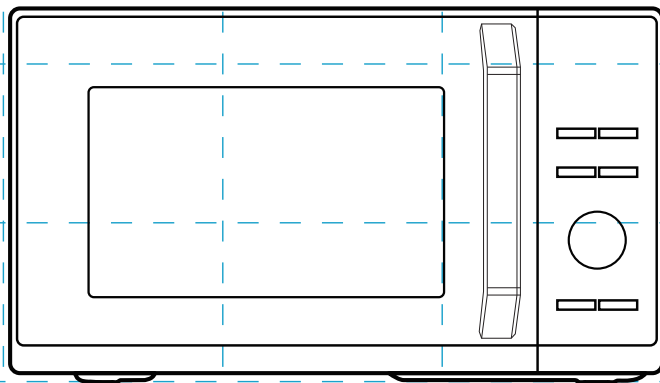

TOSHIBA

SADRŽAJ

SIGURNOST PROIZVODA

Mjere opreza za izbjegavanje mogućeg izlaganja prekomjernoj mikrovalnoj energiji	HR-01
Važne sigurnosne upute	HR-03
Ugradnja uzemljenja	HR-08
Čišćenje.....	HR-10
Posuđe.....	HR-11
Materijali koje smijete rabiti u mikrovalnoj pećnici.....	HR-12
Materijali koje ne smijete rabiti u mikrovalnoj pećnici.....	HR-14

POSTAVLJANJE PROIZVODA

Postavljanje pećnice	HR-15
----------------------------	-------

UPUTE ZA UPORABU

Prije prve uporabe.....	HR-18
Rukovanje	HR-19
1. Razine snage.....	HR-20
2. Postavljanje sata	HR-20
3. Kuhinjski mjerač vremena	HR-21
4. Kuhanje u mikrovalnoj pećnici	HR-22
5. Roštilj ili kombinirani način rada.....	HR-22
6. Konvekcija s prethodnim zagrijavanjem.....	HR-23
7. Konvekcija bez prethodnog zagrijavanja	HR-24
8. Izbornik prženja na vrući zrak.....	HR-25
9. Automatski izbornik i izbornik hrskavog roštilja	HR-26
10. Odmrzavanje prema težini	HR-28
11. Odmrzavanje prema vremenu	HR-28
12. Višefazno kuhanje.....	HR-29

13. Brzo kuhanje	HR-30
14. Funkcija zaključavanja.....	HR-31
15. Funkcija upita	HR-31

ČIŠĆENJE I ODRŽAVANJE

Čišćenje.....	HR-32
Rješavanje problema	HR-34



NAPOMENA

PRIJE UPORABE OVOG PROIZVODA PROČITAJTE, SHVATITE I SLIJEDITE OVE UPUTE. SVAKAKO SPREMITE OVAJ PRIRUČNIK ZA BUDUĆU UPORABU.

SIGURNOST PROIZVODA

MJERE OPREZA ZA IZBJEGAVANJE MOGUĆEG IZLAGANJA PREKOMJERNOJ MIKROVALNOJ ENERGIJI

- (a). Ne pokušavajte se služiti pećnicom s otvorenim vratima jer to može dovesti do štetnog izlaganja mikrovalnoj energiji. Važno je da ne slomite sigurnosne blokade i da ih neovlašteno ne mijenjate.
- (b). Ne stavljajte nikakve predmete između prednje vanjske strane pećnice i vrata i ne dopustite da se prljavština ili ostaci sredstva za čišćenje nakupe na brtvenim površinama.
- (c). **UPOZORENJE:** Ako su vrata ili brtve vrata oštećeni, pećnicu ne smijete rabiti dok je ne popravi ovlaštena osoba.

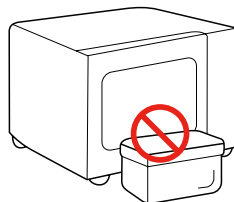

DODATAK

Ako se uređaj ne održava čistim, njegova bi se površina mogla oštetiti i to bi moglo utjecati na životni vijek uređaja te dovesti do opasne situacije.

SPECIFIKACIJE

MODEL	MW3-AC26SF(WH)
NAZIVNI NAPON/FREKVENCIJA	230 – 240 V ~ 50 Hz
NAZIVNA ULAZNA SNAGA (MIKROVALNA)	1450 W
NAZIVNA IZLAZNA SNAGA (MIKROVALNA)	900 W
NAZIVNA ULAZNA SNAGA (ROŠTILJ)	1000 W
NAZIVNA ULAZNA SNAGA (KONVEKCIJA)	2100 W



NAPOMENA

Sve slike u ovom priručniku služe samo u ilustrativne svrhe i mogu se malo razlikovati od kupljene opreme; pogledajte stvarni proizvod.

VAŽNE SIGURNOSNE UPUTE



UPOZORENJE

Kako bi se smanjio rizik od požara, strujnog udara, tjelesnih ozljeda ili izlaganja prekomjernoj mikrovalnoj energiji pri uporabi uređaja, pridržavajte se osnovnih mjera opreza, što uključuje sljedeće:



Pročitajte i slijedite:
**"MJERE OPREZA ZA
IZBJEGAVANJE
MOGUĆEG IZLAGANJA
PREKOMJERNOJ
MIKROVALNOJ
ENERGIJI".**



Ovim se uređajem smiju služiti djeca starija od 8 godina i osobe sa smanjenim tjelesnim, osjetilnim ili mentalnim sposobnostima ili manjkom iskustva i znanja uz nadzor ili upute o sigurnoj upotrebi uređaja te ako razumiju potencijalne opasnosti. Djeca se ne smiju igrati s uređajem.



Djeca ne smiju održavati uređaj bez nadzora.



Držite uređaj i njegov kabel izvan dohvata djece mlađe od 8 godina.





Ako je kabel za napajanje oštećen, radi izbjegavanja opasnosti mora ga zamijeniti proizvođač, njegov servisni zastupnik ili slično kvalificirana osoba.



UPOZORENJE: Uređaj isključite prije zamjene lampe kako biste izbjegli mogućnost električnog udara.

VAŽNE SIGURNOSNE UPUTE

 **UPOZORENJE:** Opasno je da bilo tko osim ovlaštene osobe obavlja servis ili popravak koji uključuje uklanjanje poklopca koji štiti od izlaganja mikrovalnoj energiji.

 **UPOZORENJE:** Tekućine i drugu hranu ne smijete grijati u zatvorenim spremnicima jer bi mogli eksplodirati.

 Pri zagrijavanju hrane u plastičnim i papirnatim posudama pazite na pećnicu zbog mogućeg zapaljenja.

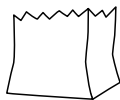

 Služite se isključivo posuđem koje je prikladno za uporabu u mikrovalnim pećnicama.

 Ako se pojavi dim, isključite ili iskopčajte uređaj iz utičnice i ostavite vrata zatvorenima kako biste ugušili plamen.

 Zagrijavanje napitaka u mikrovalnoj pećnici može dovesti do odgođenog eruptivnog vrenja, stoga treba biti oprezan pri rukovanju spremnikom.

 Sadržaj bočica za djecu i staklenki s dječjom hranom treba promiješati ili protresti, a prije uporabe morate provjeriti temperaturu kako biste izbjegli opekline.

VAŽNE SIGURNOSNE UPUTE

-  Pećnicu treba redovito čistiti i ukloniti sve ostatke hrane. Pobrinite se da područje valovoda bude čisto. Ostatke prskanja hrane na valovodu i u unutrašnjosti pećnice očistite mekom vlažnom krpom. Ako ne očistite ostatke hrane, može doći do neškodljivog iskrenja ili dima u unutrašnjosti mikrovalne pećnice, a može doći i do promjene njezine boje.

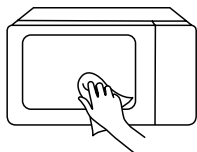

-  Neodržavanje pećnice u čistom stanju moglo bi dovesti do propadanja površine, a to bi moglo negativno utjecati na vijek trajanja uređaja i moguće dovesti do opasne situacije.

-  Služite se isključivo temperaturnom sondom preporučenom za ovu pećnicu. (Za pećnice opremljene uređajem za primjenu sonde za osjet temperature.)

-  Mikrovalna pećnica mora se rabiti s otvorenim dekorativnim vratima. (Za pećnice s dekorativnim vratima.)

-  Ovaj uređaj namijenjen je uporabi u kućanstvu i sličnim primjenama, kao što su:
1. prostori kuhinja za osoblje u trgovinama, uredima i drugim radnim okruženjima;
 2. za klijente u hotelima, motelima i drugim objektima rezidencijalnog tipa;
 3. seoske kuće;
 4. ugostiteljski objekti koji nude noćenje i doručak.

VAŽNE SIGURNOSNE UPUTE

 Mikrovalna pećnica namijenjena je zagrijavanju hrane i napitaka. Sušenje hrane ili odjeće te zagrijavanje jastučića za grijanje, papuča, spužvi, vlažnih krpa i slično može dovesti do opasnosti od ozljeda, zapaljenja ili požara.

 Uređaj je dizajniran kao samostojeći.

 Stražnju površinu uređaja postavite uza zid.

 Dok uređaj radi, temperatura dostupnih površina može biti visoka.

 **UPOZORENJE:** Kada uređaj radi u kombiniranom načinu

rada, djeca bi se trebala služiti pećnicom samo pod nadzorom odrasle osobe zbog stvorenih temperatura.

 Jaja u ljusci i cijela tvrdokuhana jaja ne smiju se zagrijavati u mikrovalnoj pećnici jer bi mogla eksplodirati, čak i nakon završetka zagrijavanja u mikrovalnoj pećnici.

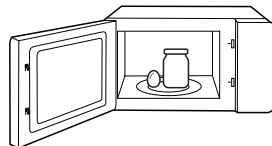



 Uređaj ne smijete postaviti iza dekorativnih vrata kako biste izbjegli pregrijavanje. (Ovo se ne odnosi na uređaje s dekorativnim vratima.)

VAŽNE SIGURNOSNE UPUTE

 Mikrovalnu pećnicu ne smijete postavljati u ormarić, osim ako nije testirana u ormariću.

 Metalni spremnici za hranu nisu dozvoljeni tijekom kuhanja u mikrovalnoj pećnici.

 Uređaj ne smijete čistiti parnim čitačem.

 Uređaj nije namijenjen za upravljanje s pomoću vanjskog mjerača vremena ili zasebnog sustava daljinskog upravljanja.

**PAŽLJIVO PROČITAJTE I SAČUVAJTE
ZA BUDUĆU UPORABU**

UPUTE ZA UZEMLJENJE RADI SMANJENJA RIZIKA OD FIZIČKIH OZLJEDA

Ovaj aparat mora biti uzemljen. U slučaju kratkog spoja, uzemljenje smanjuje rizik od strujnog udara tako što odvodi električnu struju.

Ovaj aparat je opremljen kabelom koji ima provodnik uzemljenja s uzemljenim utikačem. Utikač se mora prikopčati u utičnicu koja je pravilno ugrađena i uzemljena.

UPOZORENJE - Nepravilno korištenje uzemljenja može dovesti do rizika od strujnog udara. Ako upute za uzemljenje ne razumijete u potpunosti ili ste u nedoumici da li je aparat pravilno uzemljen, posavjetujte se s kvalificiranim električarom ili serviserom.

Ako morate koristiti produžni kabel, koristite isključivo 3-žilni produžni kabel.



OPASNOST

Opasnost od električne utičnice:
Dodirivanje nekih unutarnjih komponenti
može izazvati ozbiljne fizičke ozljede ili smrt.
Nemojte rasklapati ovaj aparat.

UPUTE ZA UZEMLJENJE RADI SMANJENJA RIZIKA OD FIZIČKIH OZLJEDA



UPOZORENJE

Opasnost od električne utičnice:

Neppravilno korištenje uzemljenja može dovesti do strujnog udara. Nemojte prikopčavati aparat u utičnicu dok ne bude pravilno postavljen i uzemljen.

1. Priložen je kratak kabel za napajanje kako bi se smanjili rizici koji proističu iz zapetljavanja ili spoticanja o dulji kabel.
2. Ako se koristi dugačak ili produžni kabel:
 - (1). Naznačena električna snaga seta kabela ili produžnog kabela mora biti barem jednaka električnoj snazi aparata.
 - (2). Produžni kabel mora biti 3-žilni uzemljeni kabel.
 - (3). Dulji kabel se mora postaviti tako da ne pada preko radne ploče ili ploče stola gdje ga djeca mogu povući ili se slučajno spotaknuti o njega.

ČIŠĆENJE

Povedite računa da aparat iskopčate s napajanja.

1. Očistite unutarnjost pećnice nakon uporabe blago navlaženom krpom.
2. Očistite dodatke na uobičajen način sapunicom.
3. Okvir vrata, brtva i okolni dijelovi moraju se pažljivo očistiti mekom krpom kad se zaprljaju.
4. Nemojte koristiti jaka abrazivna sredstva za čišćenje ili oštre metalne strugače za čišćenje stakla na vratima pećnice jer oni mogu izgubiti površinu, što može dovesti do lomljenja stakla.
5. Savjet za čišćenje---Radi lakšeg čišćenja zidova unutarnjosti koje može dodirnuti hrana koja se kuha: Stavite polovicu limuna u činiju, dodajte 300 ml vode i zagrijavajte je na 100% mikrovalne snage 10 minuta. Obrišite pećnicu čistom, suhom krpom.

POSUĐE



OPREZ

Opasnost od fizičke ozljede:

Opasno je da bilo tko osim stručne osobe obavlja bilo kakvo servisiranje ili popravke koji obuhvaćaju uklanjanje poklopca koji štiti od izlaganja mikrovalnoj energiji. Pogledajte upute pod naslovom „**Materijali koji se mogu koristiti u mikrovalnoj pećnici**“ ili „**Materijali koji se ne mogu koristiti u mikrovalnoj pećnici**“

Određeno nemetalno posuđe može biti nesigurno za korištenje u mikrovalnoj pećnici. Ako ste u nedoumici, možete ispitati posudu o kojoj je riječ slijedeći postupak opisan u nastavku.

Test posude:

1. Napunite posudu sigurnu za uporabu u mikrovalnoj 1 šoljom vode (250 ml) pored posude o kojoj je riječ.
2. Kuhajte na maksimalnoj snazi 1 min.
3. Pažljivo napunite posudu. Ako je prazna posuda topla, nemojte je koristiti za kuhanje u mikrovalnoj pećnici.
4. Nemojte kuhati dulje od 1 min.

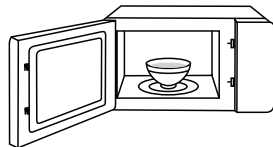





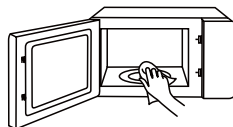











NAPOMENA

ODRŽAVATE UNUTARNJOST
I OBLAST USMJERIVAČA
VALOVA ČISTIM



MATERIJALI KOJI SE MOGU KORISTITI U MIKROVALNOJ PEĆNICI

POSUĐE	NAPOMENE	
 Posuda za pečenje	Slijedite upute proizvođača. Dno posude za pečenje mora biti najmanje 5 mm iznad okretne ploče. Nepravilno korištenje može dovesti do lomljenja okretne ploče.	
 Posuđe za jelo	Samo siguran za uporabu u mikrovalnoj pećnici. Slijedite upute proizvođača. Ne koristiti naprslo ili okružano posuđe.	
 Staklenke	Uvijek skloniti poklopac. Koristiti samo za zagrijavanje hrane samo dok ne bude topla. Većina staklenki nije otporna na toplinu i mogu se polomiti.	
 Stakleno posuđe	Samo staklene posude za pečenje otporne na toplinu. Voditi računa da posuda bude bez metalnog premaza. Ne koristiti naprslo ili okružano posuđe.	
 Kese za kuhanje u pećnici	Slijedite upute proizvođača. Ne zatvarati metalnom vezicom. Napraviti proreze kako bi para mogla izaći.	
 Papirni tanjuri i čaše	Koristiti samo za kratkotrajno kuhanje/zagrijavanje. Ne ostavljajte pećnicu bez nadzora tijekom kuhanja.	
 Papirni ubrusi	Koristiti za pokrivanje hrane kod podgrijavanja i za upijanje masnoće. Koristiti uz nadzor samo za kratkotrajno kuhanje.	
 Pergament papir	Koristiti za pokrivanje kako bi se spriječilo prskanje ili umotati kod kuhanja na pari.	

MATERIJALI KOJI SE MOGU KORISTITI U MIKROVALNOJ PEĆNICI

POSUDE

NAPOMENE



Plastika

Samo siguran za uporabu u mikrovalnoj pećnici. Slijediti upute proizvođača. Treba imati oznaku „Sigurno za mikrovalnu“. Neke plastične posude se razmekšaju kad se hrana u njima zagrije. „Kese za kuhanje“ i hermetički zatvorene plastične kese moraju se preseći, probušiti ili se na njima treba napraviti otvor prema uputama za odgovarajuću ambalažu.



Plastična folija

Samo siguran za uporabu u mikrovalnoj pećnici. Koristiti za pokrivanje hrane tijekom kuhanja kako bi se zadržala vlaga. Pazite da plastična folija ne dodiruje hranu.

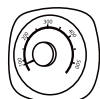

Termometri

Samo sigurni za uporabu u mikrovalnoj pećnici (termometri za meso i slatkiše).



Voštani papir

Koristiti kao poklopac radi sprječavanja prskanja i zadržavanje vlage.



MATERIJALI KOJI SE NE MOGU KORISTITI U MIKROVALNOJ PEĆNICI

POSUDE

NAPOMENE



Aluminijska posuda

Može izazvati iskrenje. Prebacite hranu u posudu sigurnu za korištenje u mikrovalnoj pećnici.



Kartonska posuda za hranu s metalnom drškom

Može izazvati iskrenje. Prebacite hranu u posudu sigurnu za korištenje u mikrovalnoj pećnici.



Posuđe od metala ili s metalnim premazom

Metalni štiti hranu od mikrovalne energije. Metalni premaz može izazvati iskrenje.



Metalne uvrnute vezice

Može izazvati iskrenje i požar u pećnici.



Papirne vrećice

Može izazvati požar u pećnici.



Plastična pjena

Plastična pjena se može istopiti ili onečistiti tekućinu u unutarnjosti kad se izloži visokoj temperaturi.



Drvo

Drvo će se osušiti kad se koristi u mikrovalnoj pećnici i može se podijeliti ili naprsnuti.



POSTAVLJANJE PROIZVODA

POSTAVLJANJE PEĆNICE

(U slučaju bilo kakvih razlika između uređaja i slika u ovom priručniku, proizvod ima prednost.)

NAZIVI DIJELOVA MIKROVALNE PEĆNICE I PRIBORA

Pećnicu i sve materijale izvadite iz kutije. Također izvadite sve iz unutrašnjosti pećnice.

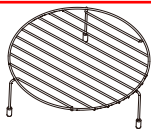

Visoka rešetka za roštilj

Rešetka za roštilj (ne može se rabiti s funkcijom mikrovalne pećnice i mora se staviti na stakleni pladanj)

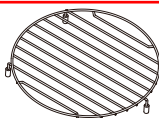

Niska rešetka za roštilj

Rešetka za roštilj (ne može se rabiti s funkcijom mikrovalne pećnice i mora se staviti na stakleni pladanj)

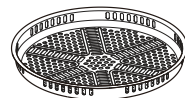

Lim za pečenje (ne može se rabiti s funkcijom mikrovalne pećnice i može se staviti na rešetku za roštilj)



Stakleni pladanj

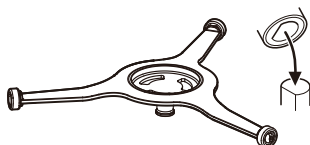

Sklop prstena okretne platforme



Korisnički priručnik

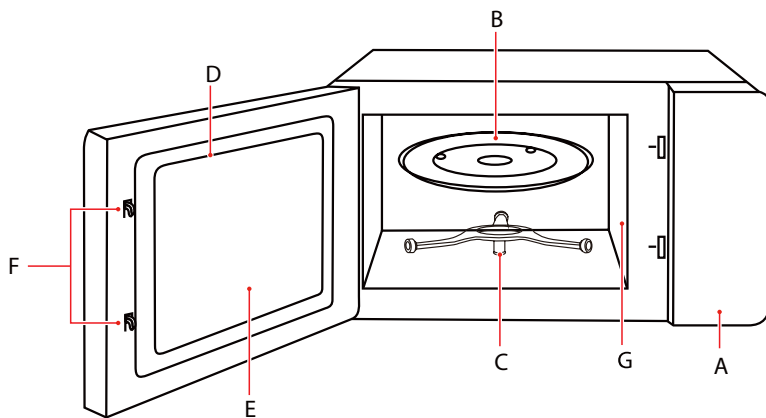

A) Upravljačka ploča

B) Stakleni pladanj

C) Sklop prstena okretne platforme

D) Sklop vrata

E) Okno za promatranje

F) Sigurnosni sustav za zaključavanje

G) Pokrov valovoda

POSTAVLJANJE PEĆNICE

POSTAVLJANJE OKRETNE PLATFORME

Očistite unutrašnjost pećnice i postavite okretnu platformu na njezino mjesto.

Za nove instalacije, provjerite jesu li sve ambalažne i transportne trake uklonjene s osovine okretne platforme.

Prije prve uporabe uređaja za pripremu hrane morat ćete pravilno postaviti okretnu platformu. Morate očistiti unutrašnjost pećnice i pribor. Možete pogledati i odjeljak o čišćenju.

Kako postaviti okretnu platformu:

1. Postavite prsten okretne platforme ② u udubljenje unutar pećnice.
2. Postavite stakleni pladanj ① na prsten okretne platforme ②.

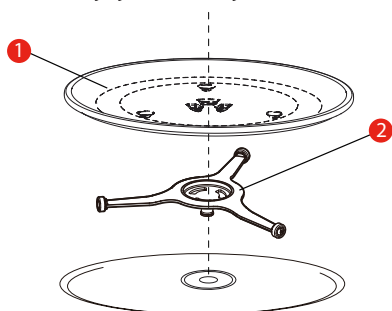

- 1) Stakleni pladanj
- 2) Sklop prstena okretne platforme

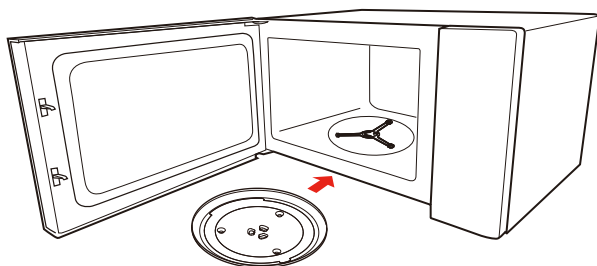

NAPOMENA

- Nikada nemojte rabiti uređaj bez okretne platforme. Uvjerite se da je ispravno učvršćena. Okretna platforma može se okretati u smjeru kazaljke na satu ili u suprotnom smjeru.
- Nikada ne stavljajte stakleni pladanj naopako. Stakleni pladanj nikada se ne smije ograničavati u kretanju.
- Tijekom kuhanja uvijek se moraju koristiti i stakleni pladanj i sklop prstena okretne platforme.
- Sva hrana i spremnici hrane uvijek se stavljaju na stakleni pladanj za kuhanje.
- Nikada nemojte ograničavati kretanje okretne platforme.
- Ako stakleni pladanj ili sklop prstena okretne platforme pukne ili se slomi, obratite se najbližem ovlaštenom servisu.

POSTAVLJANJE NA RADNU POVRŠINU

Uklonite svu ambalažu i pribor. Provjerite ima li pećnica bilo kakva oštećenja kao što su udubljenja ili slomljena vrata. Nemojte postavljati pećnicu ako je oštećena.

Kućište: Uklonite svu zaštitnu foliju s površine kućišta mikrovalne pećnice. Nemojte uklanjati svjetlosmeđi poklopac od tinjca koji je pričvršćen na unutrašnjost pećnice radi zaštite magnetrona.

POSTAVLJANJE

1. Odaberite ravnu površinu koja osigurava dovoljno otvorenog prostora za ulazne i/ili izlazne otvore.

a. Minimalna visina postavljanja je 85 cm.

b. Stražnja površina uređaja mora biti postavljena uza zid. Ostavite najmanje 30 cm slobodnog prostora iznad pećnice. Između pećnice i susjednih zidova potrebno je ostaviti najmanje 20 cm slobodnog prostora.

c. Ne uklanjajte nožice s dna pećnice.

d. Blokiranje ulaznih i/ili izlaznih otvora može oštetiti pećnicu.

e. Pećnicu postavite što dalje od radija i TV prijamnika. Rad mikrovalne pećnice može uzrokovati smetnje radijskog ili TV prijama.

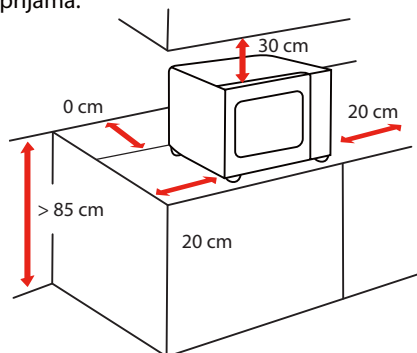

2. Priključite pećnicu na standardnu kućnu električnu utičnicu. Provjerite jesu li napon i frekvencija isti kao napon i frekvencija na natpisnoj pločici.



NAPOMENA

- Pećnicu nemojte postavljati iznad ploče za kuhanje ili drugog uređaja koji proizvodi toplinu. Ako se postavi u blizini ili iznad izvora topline, pećnica bi se mogla oštetiti i jamstvo više neće vrijediti.

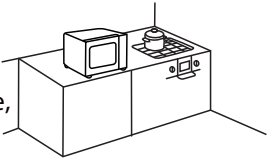



Dostupna površina može se zagrijati tijekom rada.

PRIJE PRVE UPORABE

Normalno je da pećnica pri prvoj uporabi može proizvesti neugodne mirise.

Ovaj odjeljak opisuje sve što trebate učiniti prije prve uporabe mikrovalne pećnice za pripremu hrane. Unaprijed pročitajte odjeljak pod nazivom "**SIGURNOST PROIZVODA**".

Prije uporabe novog uređaja morat ćete pravilno postaviti okretnu platformu. Usto morate očistiti unutrašnjost pećnice i pribor.



NAPOMENA

- Nikada nemojte rabiti uređaj bez okretno platforme.
- Provjerite je li pravilno postavljena. Okretna platforma može se okretati u smjeru kazaljke na satu ili u suprotnom smjeru.

RUKOVANJE

UPRAVLJAČKA PLOČA I ZNAČAJKE

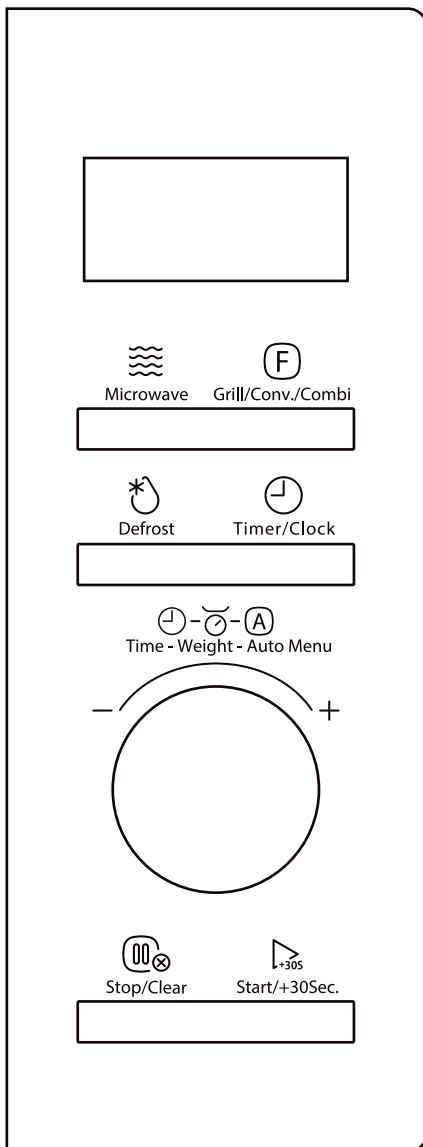

1. RAZINE SNAGE

Dostupno je 5 razina snage.

RAZINA	SNAGA	ZASLON
1	100 %	P100
2	80 %	P80
3	50 %	P50
4	30 %	P30
5	10 %	P10

2. POSTAVLJANJE SATA

Kad se mikrovalna pećnica priključi u utičnicu, prikazat će se "0:00".

- a** Dvaput pritisnite  Timer/Clock i prikazat će se 00:00.



- b** Okrenite gumb za postavljanje sati unutar raspona 0 – 23.



- c** Pritisnite  Start/+30Sec. ili  Timer/Clock za potvrdu vrijednosti sati.

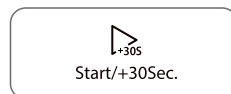

- d** Okrenite gumb za postavljanje brojki minuta unutar raspona 0 – 59.

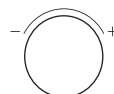

e Pritisnite  Start/+30Sec. ili  Timer/Clock za potvrdu odabira.



- Ako sat nije postavljen, neće raditi dok je pećnica uključena.
- Ako pri postavljanju sata nema nikakvih radnji u roku od 5 minuta ili izravno pritisnete , zaslon će se automatski vratiti na prethodnu postavku sata.

3. KUHINJSKI MJERAČ VREMENA

Kad se mikrovalna pećnica priključi u utičnicu, prikazat će se "0:00".

a Pritisnite  Timer/Clock jednom.



b Okrenite gumb za postavljanje vremena unutar raspona 0:05 – 95:00.



c Pritisnite  Start/+30Sec. za početak odbrojavanja.



- Postavka kuhinjskog mjerača vremena razlikuje se od postavke sata; to je samo brojač vremena.
- Dok je funkcija kuhinjskog mjerača vremena uključena, nije moguće pokrenuti nijednu od funkcija kuhanja.

4. KUHANJE U MIKROVALNOJ PEĆNICI

Kad se mikrovalna pećnica priključi u utičnicu, prikazat će se "0:00".

a ili Pritisnite  Microwave više puta za odabir razine snage.

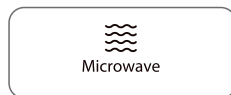

a ili Pritisnite  Microwave jednom, a zatim okrenite gumb kako biste postavili stupanj snage.



b Pritisnite  Start/+30Sec. za potvrdu razine snage.



c Okrenite gumb kako biste postavili vrijeme; maksimalna vrijednost vremena je "95:00".

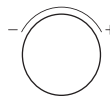

d Pritisnite  Start/+30Sec. kako biste započeli s kuhanjem.



5. ROŠTILJ ILI KOMBINIRANI NAČIN RADA

a ili Pritisnite  Grill/Conv./Combi više puta za odabir načina rada.



a ili Pritisnite  Grill/Conv./Combi jednom, a zatim okrenite gumb za odabir načina rada.





Redom će se prikazivati "G-1, C-1...C-4, 150 °C, 160 °C.....240 °C". ("G-1" je roštilj, "C-1 ~ C-4" kombinirani način rada).

- b** Pritisnite  Start/+30Sec. za potvrdu načina rada.

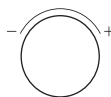

- c** Okrenite gumb kako biste postavili vrijeme; maksimalna vrijednost vremena je "95:00".



- d** Pritisnite  Start/+30Sec. kako biste započeli s kuhanjem.



 **NAPOMENA**

- Nakon što prođe pola vremena, oglasit će se zvučni signal kako bi vas podsjetio da preokrenete hranu tijekom pečenja. Ako to ne učinite, pećnica će nastaviti s radom.

6. KONVEKCIJA S PRETHODNIM ZAGRIJAVANJEM

- a** Pritisnite  Grill/Conv./Combi više puta za odabir temperature konvekcije.



ili

- a** Pritisnite  Grill/Conv./Combi jednom, a zatim okrenite gumb za odabir temperature konvekcije. Dostupne su temperature 150 °C, 160 °C.....240 °C.



- b** Dvapat pritisnite  Start/+30Sec. za početak zagrijavanja. Po završetku zagrijavanja temperatura će zatreptati; otvorite vrata i stavite hranu u pećnicu.



- c** Okrenite gumb kako biste postavili vrijeme; maksimalna vrijednost vremena je "95:00".

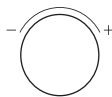

- d** Pritisnite  Start/+30Sec. kako biste započeli s kuhanjem.



7. KONVEKCIJA BEZ PRETHODNOG ZAGRIJAVANJA

- a** Pritisnite  Grill/Conv./Combi više puta za odabir temperature konvekcije.



a ili

- a** Pritisnite  Grill/Conv./Combi jednom, a zatim okrenite gumb za odabir temperature konvekcije. Dostupne su temperature 150 °C, 160 °C..... 240 °C.

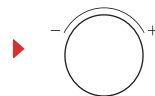

- b** Pritisnite  Start/+30Sec. za potvrdu temperature.



- c** Okrenite gumb kako biste postavili vrijeme; maksimalna vrijednost vremena je "95:00".

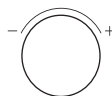



- d** Pritisnite  Start/+30Sec. kako biste započeli s kuhanjem.

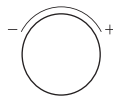

8. IZBORNİK PRŽENJA NA VRUĆI ZRAK

- a** U stanju čekanja okrenite gumb udesno za ulazak u funkciju izbornika.
Opetovano okrećite gumb kako biste odabrali izbornik H-1.



- b** Pritisnite  Start/+30Sec. za potvrdu vrste izbornika.



- c** Okrenite gumb kako biste odabrali podizbornik.

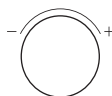

- d** Pritisnite  Start/+30Sec. kako biste započeli s kuhanjem.



TABLICA IZBORNİKA PRŽENJA NA VRUĆI ZRAK

ZASLON	IZBORNİK	TEŽINA
H-1	Zamrznuti pomfrit	300 g
H-2	Smrznuti kroketi od krumpira	350 g
H-3	Smrznute lignje	250 g
H-4	Smrznuti kolutići luka	250 g
H-5	Smrznuti pileći medaljoni	350 g
H-6	Escalope	400 g
H-7	Škampi	250 g
H-8	Povrće	200 g
H-9	Proletne rollice	300 g

Napomena: U izborniku prženja na vrući zrak težina se ne može birati.

9. AUTOMATSKI IZBORNIK I IZBORNIK HRŠKAVOG ROŠTILJA

- a** U stanju čekanja okrenite gumb udesno za ulazak u funkciju izbornika. Opetovano okrećite gumb kako biste odabrali automatski izbornik (zaslon A-1) ili izbornik hrškavog roštilja (zaslon C-1). Na primjer, odaberite C-1.

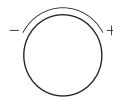

- b** Pritisnite  Start/+30Sec. za potvrdu odabira.



- c** Okrenite gumb kako biste odabrali podizbornik; dostupni su C-1 ~ C-4.

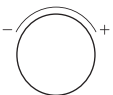

- d** Pritisnite  Start/+30Sec. za potvrdu odabira. Okrenite gumb za odabir težine. Težina za C-3 i C-4 ne može se birati.



- e** Pritisnite  Start/+30Sec. za potvrdu odabira.



TABLICA IZBORNIKA HRŠKAVOG ROŠTILJA

ZASLON	IZBORNIK	TEŽINA
C-1	Cordon bleu	300 g
		600 g
		900 g
C-2	lazanje	200 g
		300 g
		400 g
		500 g
C-3	kruh	100 g
C-4	pita/tart	8 (oko 350 g)

TABLICA AUTOMATSKOG IZBORNIKA

IZBORNIK	ZASLON	TEŽINA/ KOLIČINA	RAZINA SNAGE
A-1 AUTOMATSKO PODGRIJAVANJE	150 g	150 g	P100
	250 g	250 g	
	350 g	350 g	
	450 g	450 g	
	600 g	600 g	
A-2 KRUMPIR	1	1 (oko 230 g)	P100
	2	2	
	3	3	
A-3 MESO	150 g	150 g	P80
	300 g	300 g	
	450 g	450 g	
	600 g	600 g	
A-4 POVRĆE	150 g	150 g	P100
	350 g	350 g	
	500 g	500 g	
A-5 RIBA	150 g	150 g	P80
	250 g	250 g	
	350 g	350 g	
	450 g	450 g	
	650 g	650 g	
A-6 TJESTENINA	50 g (s hladnom vodom 450 g)	50 g	P80
	100 g (s hladnom vodom 800 g)	100 g	
	150 g (s hladnom vodom 1200 g)	150 g	
A-7 JUHA	200 g	200 g	P100
	400 g	400 g	
	600 g	600 g	
A-8 KOLAČ	475 g	475 g	CONVEC.160°C (S prethodnim zagrijavanjem na 160 °C)
A-9 PIZZA	100 g	100 g	C-4
	200 g	200 g	
	300 g	300 g	
A10 PILETINA	500 g	500 g	C-4
	750 g	750 g	
	1000 g	1000 g	
	1200 g	1200 g	

10. ODMRZAVANJE PREMA TEŽINI

- a** Pritisnite  Defrost jednom i prikazat će se "dEF1".



- b** Okrenite gumb kako biste postavili težinu hrane; trebala bi biti unutar raspona 100 – 2000 g.

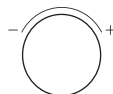

- c** Pritisnite  Start/+30Sec. kako biste započeli s odmrzavanjem.



NAPOMENA

- Zvučni signal dvaput će se oglasiti kako bi vas podsjetio da preokrenete hranu tijekom odmrzavanja.

11. ODMRZAVANJE PREMA VREMENU

- a** Dvaput pritisnite  Defrost i prikazat će se "dEF2".

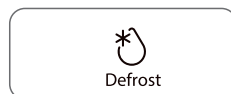

- b** Okrenite gumb kako biste postavili vrijeme. Maksimalna vrijednost vremena je "95:00".

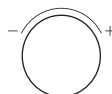

- c** Pritisnite  Start/+30Sec. kako biste započeli s odmrzavanjem.

Start/+30Sec.



NAPOMENA

- Nakon što prođe pola vremena, oglasit će se zvučni signal kako bi vas podsjetio da preokrenete hranu.
- Zadana razina snage je P30 i ne može se mijenjati.

12. VIŠEFAZNO KUHANJE

- a** Dvapat pritisnite  Defrost i prikazat će se "dEF2".



Defrost

- b** Okrenite gumb kako biste postavili vrijeme; maksimalna vrijednost vremena je "95:00".



- c** Pritisnite  Grill/Conv./Combi za odabir načina kuhanja.



Grill/Conv./Combi

- d** Pritisnite  Start/+30Sec. za potvrdu odabira.

Start/+30Sec.

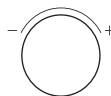
- e** Okrenite gumb kako biste postavili vrijeme; maksimalna vrijednost vremena je "95:00".



- f** Pritisnite  Start/+30Sec. kako biste započeli s kuhanjem.



- U višefaznom kuhanju mogu se postaviti dvije faze kuhanja.
- Ako postavite funkciju odmrzavanja, ona će automatski raditi u prvoj fazi.
- Kuhinjski mjerac vremena, automatski izbornik, brzo kuhanje i prethodno zagrijavanje ne mogu se postaviti kao jedna od faza.

13. BRZO KUHANJE

- a** Okrenite gumb jednom ulijevo za izravan odabir načina kuhanja sa 100 % snage 5 sekundi.



- b** Okrenite gumb kako biste postavili vrijeme. Maksimalna vrijednost vremena je "95:00".



- c** Pritisnite  Start/+30Sec. kako biste započeli s kuhanjem.



- a** Pritisnite  Start/+30Sec. jednom za izravan odabir kuhanja sa 100 % snage 30 sekundi.



14. FUNKCIJA ZAKLJUČAVANJA

- a** Za zaključavanje mikrovalne pećnice tako da njome ne mogu rukovati djeca ili drugi neželjeni korisnici, pritisnite i držite tipku  3 sekunde i prikazat će se ikona zaključavanja.
Stop/Clear



- b** Za otključavanje pritisnite i držite tipku  Stop/Clear 3 sekunde.



15. FUNKCIJA UPITA

- a** Dok pećnica radi, pritisnite  Timer/Clock i trenutno vrijeme prikazivat će se na zaslonu tri sekunde.



ČIŠĆENJE I ODRŽAVANJE

ČIŠĆENJE

Uz dobro održavanje i čišćenje, aparat će sačuvati svoj izgled i ostat će potpuno funkcionalan dugo vremena. Ovdje ćemo vam objasniti kako trebate pravilno održavati i čistiti svoj aparat.



UPOZORENJE

- Izgrebano staklo na vratima aparata može se pretvoriti u naprslinu. Nemojte koristiti stakleni strugač, oštre ili abrazivne alate za čišćenje ili deterdžente.
- Površina aparata se može oštetiti ako se čisti na odgovarajući način. Mikrovalna energija može izaći vani. Redovito čistite aparat i odmah uklonite sve ostatke hrane.
- Nemojte potapati aparat u vodu niti ga čistiti pod mlazom vode.

Sredstvo za čišćenje

Da se različite površine ne bi oštetile korištenjem pogrešnog sredstva za čišćenje, imajte u vidu niže navedene informacije. Temeljno operite spužvaste krpe prije uporabe.

Nemojte koristiti:



Jaka ili agresivna sredstva
za čišćenje



Metalni ili stakleni strugači
za čišćenje panela vrata



Metalni ili stakleni strugači
za čišćenje brtve vrata



Tvrđi jastučići ili
spužve za ribanje



Sredstva za čišćenje sa
visokim sadržajem alkohola

PREDNJA STRANA APARATA

Vruća sapunica:

Čistiti pomoću krpe sa suđe a zatim osušiti mekom krpom.
Ta čišćenje nemojte koristiti metalne ili staklene strugače.

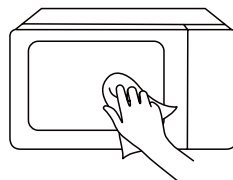

PREDNJA PLOČA APARATA

Vruća sapunica:

Čistiti pomoću krpe sa suđe a zatim osušiti mekom krpom. Odmah uklonite tragove prskanja i naslage krečnjaka, masti, skroba i albumina. Ispod tih naslaga i tragova od prskanja može nastati korozija. Za čišćenje nemojte koristiti sredstva za čišćenje stakla niti metalne ili staklene strugače.

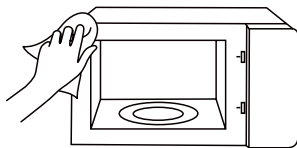

UNUTRAŠNOST APARATA

Vruća sapunica ili rastvor octa:

Čistiti pomoću krpe sa suđe a zatim osušiti mekom krpom. Nemojte koristiti sprej za pećnice ili neka druga agresivna sredstva za čišćenje ili abrazivne materijale. Žice za ribanje, abrazivne spužve i sredstva za čišćenje posuđa također nisu pogodna za uporaba. Ta sredstva grebu površinu. Sačekajte da se unutarnje površine potpuno osuše.

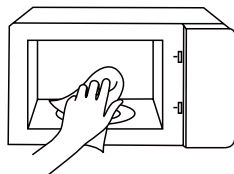

UDUBLJENJE U ODJELJKU ZA KUHANJE

Vlažna krpa:

Ne smije se dopustiti da voda uđe u aparat kroz okretnu ploču. Osušite okretnu ploču krpom.

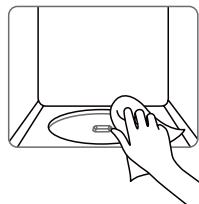

OKRETNNA PLOČA I PRSTEN VALJKA

Vruća sapunica:

Prilikom stavljanja okretnne ploče u udubljenje, ona mora pravilno nalegnuti.



PANEL VRATA

Sredstvo za čišćenje stakla:

Čistiti krpom za suđe. Ne koristiti abrazivna sredstva za staklo.

ODRŽAVANJE

RJEŠAVANJE PROBLEMA

Isprobajte rješenja za svaki problem nakon što upotrijebite donju tablicu da provjerite svoj problem. Obratite se najbližem ovlaštenom servisu ako mikrovalna pećnica i dalje ne radi ispravno.

NEVOLJA	VJEROJATNI UZROK	MOGUĆE RJEŠENJE
Pećnica se ne pokreće	<ol style="list-style-type: none">Električni kabel pećnice nije uključen u utičnicu.Vrata su otvorena.Odabrana je neispravna operacija.	<ol style="list-style-type: none">Spojite u utičnicu.Zaključaj vrata i pokušaj još jednom.Provjerite upute
Zalučenje ili iskrenje	<ol style="list-style-type: none">Korišteni su predmeti koji se ne smiju koristiti u mikrovalnoj pećnici.Pećnica se koristi kada je prazna.Hrana koja se prolila ostaje u šupljini.	<ol style="list-style-type: none">Koristite samo posuđe koje je prikladno za mikrovalnu pećnicu.Nikada nemojte koristiti praznu pećnicu.Istrljajte karijes vlažnim ručnikom.
Neravnomjerno kuhana hrana	<ol style="list-style-type: none">Korišteni su predmeti koji se ne smiju koristiti u mikrovalnoj pećnici.Hrana nije u potpunosti odmrznuta.Razina snage je nedovoljna za vrijeme kuhanja.Obrok se ne okreće niti miješa.	<ol style="list-style-type: none">Koristite samo posuđe prikladno za mikrovalnu pećnicuU potpunosti odmrznite hranu.Koristite odgovarajuću snagu i vrijeme kuhanja.Promiješajte ili okrenite hranu.
Prekuhana hrana	Vrijeme kuhanja i razina snage su nedovoljni.	Koristite odgovarajuću snagu i vrijeme kuhanja.
Nedovoljno kuhana hrana	<ol style="list-style-type: none">Korišteni su predmeti koji se ne smiju koristiti u mikrovalnoj pećnici.Hrana nije u potpunosti odmrznuta.Ventilacijski otvori u pećnici su ograničeni.Vrijeme kuhanja i razina snage su neprikladni.	<ol style="list-style-type: none">Koristite samo posuđe koje je prikladno za mikrovalnu pećnicu.U potpunosti odmrznite hranu.Provjerite da ventilacijski otvori na pećnici nisu blokirani.Koristite odgovarajuće vrijeme kuhanja i razinu snage.
Neppravilno odmrzavanje	<ol style="list-style-type: none">Korišteni su predmeti koji se ne smiju koristiti u mikrovalnoj pećnici.Neodgovarajuća razina snage i vrijeme kuhanja.Bez okretanja ili ribanja hrane.	<ol style="list-style-type: none">Koristite samo posuđe prikladno za mikrovalnu pećnicu.koristite preporučeno vrijeme kuhanja i razinu snage.Bacati ili okretati hranu.



Prema Direktivi o otpadu od električne i elektroničke opreme (WEEE), WEEE treba skupljati i odlagati odvojeno. Ako ubuduće budete trebali odlagati ovaj proizvod, nemojte ga odlagati zajedno s kućnim otpadom. Molimo odnesite ovaj proizvod na sabirno mjesto WEEE gdje je dostupno.

#DetailsMatter

LIETOŠANAS PAMĀCĪBA

MIKROVIĻŅU KRĀSNS

MW3-AC26SF(WH)

Pirms lietošanas, lūdzu, izlasiet šo lietošanas pamācību.

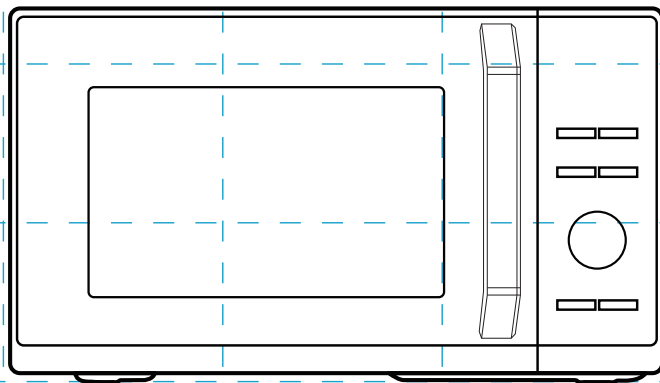

TOSHIBA

SATURS

PRODUKTA DROŠĪBA

Piesardzības pasākumi, lai izvairītos no iespējamās pakļaušanas pārmērīgai mikroviļņu enerģijai	LV-01
Svarīgi drošības norādījumi	LV-03
Zemējuma izveide.....	LV-08
Tīrīšana	LV-10
Trauki	LV-11
Materiāli, kurus drīkst izmantot mikroviļņu krāsnī.....	LV-12
Materiāli, kurus nedrīkst izmantot mikroviļņu krāsnī.....	LV-14

PRODUKTA IESTATĪŠANA

Krāsns iestatīšana	LV-15
--------------------------	-------

LIETOŠANAS INSTRUKCIJA

Pirms pirmās lietošanas reizes.....	LV-18
Lietošana	LV-19
1. Jaudas līmeņi.....	LV-20
2. Pulksteņa iestatīšana	LV-20
3. Virtuves taimeris.....	LV-21
4. Gatavošana mikroviļņu krāsnī.....	LV-22
5. Grils vai kombinācija.....	LV-22
6. Konvekcija ar priekšsildīšanu.....	LV-23
7. Konvekcija bez priekšsildīšanas.....	LV-24
8. Gaisa fritēšanas izvēlne.....	LV-25
9. Automātiskā izvēlne un kraukšķīgā grila izvēlne	LV-26
10. Atkausēšana pēc svara	LV-28
11. Atkausēšana pēc laika.....	LV-28
12. Vairākposmu gatavošana	LV-29

13. Ātra gatavošana.....	LV-30
14. Bloķēšanas funkcija	LV-31
15. Izziņas funkcija	LV-31

TĪRĪŠANA UN APKOPE

Tīrīšana	LV-32
Problēmu novēršana.....	LV-34



PIEZĪME

**PIRMS ŠĪ PRODUKTA LIETOŠANAS IZLASIET,
IZPROTIET UN IEVĒROJIET ŠOS NORĀDĪJUMUS.
NOTEIKTI SAGLABĀJIET ŠO INSTRUKCIJU TURPMĀKAI
UZZIŅAI.**

PRODUKTA DROŠĪBA

PIESARDZĪBAS PASĀKUMI, LAI IZVAIRĪTOS NO IESPĒJAMAS PAKĻAUŠANAS PĀRMĒRĪGAI MIKROVIĻŅU ENERĢIJAI

- (a). Nemēģiniet darbināt šo krāsni ar atvērtām durvīm, jo tas var izraisīt kaitīgu mikroviļņu enerģijas iedarbību. Ir svarīgi nesalauzt un nesabojāt drošības bloķētājus.
- (b). Nenovietojiet nekādus priekšmetus starp krāsni priekšējo virsmu un durvīm un neļaujiet netīrumiem vai tīrīšanas līdzekļa atlikumiem uzkrāties uz blīvējuma virsmām.
- (c). **BRĪDINĀJUMS:** Ja durvis vai durvju blīves ir bojātas, krāsni nedrīkst darbināt, kamēr to nav salabojusi kompetenta persona.

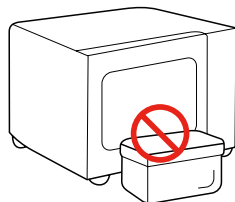

PAPILDINĀJUMS

Ja iekārta netiek uzturēta labā tīrības stāvoklī, tās virsma var tikt bojāta un ietekmēt ierīces kalpošanas laiku un izraisīt bīstamu situāciju.

SPECIFIKĀCIJAS

MODELIS	MW3-AC26SF(WH)
NOMINĀLAIS SPRIEGUMS/FREKVENCE	230-240 V~ 50 Hz
NOMINĀLĀ IEEJAS JAUDA (MIKROVIĻŅU)	1450 W
NOMINĀLĀ IZEJAS JAUDA (MIKROVIĻŅU)	900 W
NOMINĀLĀ IEEJAS JAUDA (GRILS)	1000 W
NOMINĀLĀ IEEJAS JAUDA (KONVEKCIJA)	2100 W



PIEZĪME

Visi attēli šajā rokasgrāmatā ir tikai ilustratīvi; tie var nedaudz atšķirties no iegādātā aprīkojuma, skatiet faktisko produktu.

SVARĪGI DROŠĪBAS NORĀDĪJUMI



BRĪDINĀJUMS

Lai samazinātu ugunsgrēka, elektriskās strāvas trieciena, traumu risku vai pakļaušanu pārmērīgai mikroviļņu krāsns enerģijai ierīces lietošanas laikā, ievērojiet pamata piesardzības pasākumus, tostarp šādus:



Izlasiet un ievērojiet:
"PIESARDZĪBAS PASĀKUMI, LAI IZVAIRĪTOS NO IESPĒJAMAS PAKĻAUŠANAS PĀRMĒRĪGAI MIKROVIĻŅU ENERĢIJAI".



Šo ierīci drīkst izmantot bērni vecumā no 8 gadiem, kā arī personas ar ierobežotām fiziskām, sensorām vai garīgām spējām vai bez pieredzes un zināšanām, ja tie tiek uzraudzīti vai ir saņēmuši norādījumus par ierīces drošu lietošanu un saprot ietvertos riskus. Bērni nedrīkst rotaļāties ar ierīci.



Bērni bez uzraudzības nedrīkst veikt ierīci apkopi.



Glabājiet ierīci un tās vadu bērniem, kas jaunāki par 8 gadiem, nepieejamā vietā.





Ja strāvas vads ir bojāts, tā nomaiņa jāveic ražotājam, servisa speciālistam vai līdzīgi kvalificētai personai, lai izvairītos no riska.



BRĪDINĀJUMS: Pirms lampas nomaiņas pārlicinieties, ka ierīce ir izslēgta, lai izvairītos no elektriskās strāvas trieciena.

SVARĪGI DROŠĪBAS NORĀDĪJUMI

 **BRĪDINĀJUMS:** Ikvienam, kas nav kompetenta persona, ir bīstami veikt apkopes vai remonta darbības, tostarp noņemt vāku, kas aizsargā pret mikroviļņu enerģijas iedarbību.

 **BRĪDINĀJUMS:** Šķidrumus un citus pārtikas produktus nedrīkst karsēt noslēgtos traukos, jo tie var eksplodēt.

 Sildot pārtiku plastmasas vai papīra traukos, uzmaniet krāsnī, jo pastāv aizdegšanās iespēja.

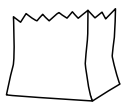

 Izmantojiet tikai tādus traukus, kas ir piemēroti lietošanai mikroviļņu krāsnīs.

 Ja izdalās dūmi, izslēdziet vai atvienojiet ierīci un turiet durvis aizvērtas, lai apslāpētu liesmas.

 Dzērienu karsēšana mikroviļņu krāsnī var izraisīt aizkavētu uzliesmojumu, tāpēc, rīkojoties ar trauku, jābūt uzmanīgiem.

 Lai izvairītos no apdegumiem, barošanas pudelišu un zīdaiņu pārtikas burciņu saturs pirms lietošanas jāsamaisa vai jāsakrata un jāpārbauda temperatūra.

SVARĪGI DROŠĪBAS NORĀDĪJUMI

 Krāsns ir regulāri jātīra un jānoņem pārtikas nogulsnes. Lūdzu, uzturiet viļņvada zonu tīru. Izmantojiet mīkstu, mitru drānu, lai to notīrītu, ja viļņvada zonā vai krāsns iekšpusē ir pārtikas šļakatu paliekas. Pārtikas atlieku netīrīšana var izraisīt nekaitīgu dzirksteļošanu vai nelielus dūmus mikroviļņu krāsns iekšpusē, kā arī var rasties krāsas izmaiņas.

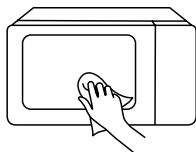

 Krāsns neuzturēšana tīrā stāvoklī var izraisīt virsmas nolietojanos, kas var negatīvi ietekmēt ierīces kalpošanas laiku un izraisīt bīstamu situāciju.

 Izmantojiet tikai šai krāsnij ieteikto temperatūras zondi. (Krāsnīm, kas aprīkotas ar iespēju izmantot temperatūras zondi.)

 Mikroviļņu krāsns jādarbina ar atvērtām dekoratīvajām durvīm. (Krāsnīm ar dekoratīvām durvīm.)

 Šī ierīce ir paredzēta lietošanai mājāsaimniecībā un līdzīgos lietojumos, piemēram:

1. personāla virtuves zonās veikalos, birojos un citās darba vidēs;
2. klientiem viesnīcās, moteļos un citās dzīvojamās vidēs;
3. lauku mājās;
4. gultasvietas un brokastu tipa vidē.

SVARĪGI DROŠĪBAS NORĀDĪJUMI

 Mikroviļņu krāsns ir paredzēta ēdienu un dzērienu sildīšanai. Pārtikas vai apģērba žāvēšana un sildīšanas paliktņu, čību, sūkļu, mitru drānu un tamlīdzīgu materiālu karsēšana var radīt traumu un aizdegšanās risku.

 Ierīci ir paredzēts lietot brīvi stāvošu.

 Ierīces aizmugures virsma jānovieto pie sienas.

 Ierīces darbības laikā pieejamo virsmu temperatūra var būt augsta.

 **BRĪDINĀJUMS:** Ja ierīce darbojas kombinētajā režīmā, bērni drīkst

izmantot krāsni tikai pieaugušo uzraudzībā, ņemot vērā radīto temperatūru.

 Oļas čaumalās un veselas cieti vārītas oļas nedrīkst karsēt mikroviļņu krāsnī, jo tās var eksplodēt pat pēc tam, kad sildīšana mikroviļņu krāsnī ir beigusies.

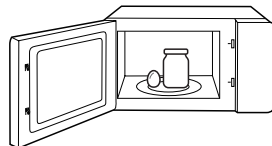



 Ierīci nedrīkst uzstādīt aiz dekoratīvām durvīm, lai izvairītos no pārkaršanas. (Tas neattiecas uz ierīcēm ar dekoratīvām durvīm.)

SVARĪGI DROŠĪBAS NORĀDĪJUMI

 Mikroviļņu krāsni nedrīkst ievietot skapī, ja tā nav pārbaudīta skapī.

 Gatavošanas laikā mikroviļņu krāsnī nav atļauts ievietot metāla traukus ēdieniem un dzērieniem.

 Ierīci nedrīkst tīrīt ar tvaika tīrītāju.

 Ierīci nav paredzēts darbināt ar ārēju taimeri vai atsevišķu tālvadības sistēmu.

RŪPĪGI IZLASIET UN SAGLABĀJIET
TURPMĀKAI UZZIŅAI

LAI SAMAZINĀTU TRAUMU RISKU PERSONĀM, SAZEMĒJIET IEKĀRTU

Šai ierīcei jābūt iezemētai. Elektriskā īssavienojuma gadījumā zemējums samazina elektriskās strāvas trieciena risku, nodrošinot elektriskās strāvas novadišanas vadu.

Šī ierīce ir aprīkota ar kabeli ar zemējuma vadu un zemējuma kontaktdakšu. Kontaktdakšai jābūt pievienotai kontaktligzdai, kas ir pareizi uzstādīta un iezemēta.

BRĪDINĀJUMS — nepareiza zemējuma izmantošana var izraisīt elektriskās strāvas trieciena risku. Konsultējieties ar kvalificētu elektriķi vai servisa speciālistu, ja zemējuma norādījumi nav pilnībā izprasti vai ja rodas šaubas par to, vai ierīce ir pareizi iezemēta. Ja nepieciešams izmantot pagarinātāju, izmantojiet tikai 3 vadu pagarinātāju.



BĪSTAMI

Elektriskās strāvas trieciena risks:
Pieskaroties dažām iekšējām sastāvdaļām, var gūt nopietnus miesas bojājumus vai letālus ievainojumus. Neizjauciet šo ierīci.

LAI SAMAZINĀTU TRAUMU RISKU PERSONĀM, SAZEMĒJIET IEKĀRTU



BRĪDINĀJUMS

Elektriskās strāvas triecienu risks:

Nepareiza zemējuma izmantošana var izraisīt elektriskās strāvas triecienu. Nepievienojiet ierīci kontaktligzdai, kamēr ierīce nav pareizi uzstādīta un iezemēta.

1. Īss barošanas vads ir nodrošināts, lai samazinātu risku, kas var rasties, sapinoties garākā vadā vai pakļūpot aiz tā.
2. Ja tiek izmantots garš vads vai pagarinātājs:
 - (1). Marķētajai vadu komplekta vai pagarinātāja elektriskajai vērtībai ir jābūt vismaz tikpat lielai kā ierīces elektriskajai nominālajai vērtībai.
 - (2). Pagarinātājam ir jābūt zemējuma tipa 3 vadu kabelim.
 - (3). Garākais vads ir jāizkārto tā, lai tas nepārklājas pāri galda virsmai vai galda virsmai, kur bērni to var pavilkēt vai nejauši pakļūpt.

TĪRĪŠANA

Noteikti atvienojiet ierīci no strāvas padeves.

1. Pēc lietošanas iztīriet cepeškrāsns kameru ar nedaudz mitru drānu.
2. Piederumus tīriet parastajā veidā ziepjūdenī.
3. Durvju rāmis un blīve un blakus esošās daļas rūpīgi jānotīra ar mitru drānu, ja tās ir netīras.
4. Cepeškrāsns durvju stikla tīrīšanai neizmantojiet spēcīgus abrazīvus tīrīšanas līdzekļus vai asus metāla skrāpjus, jo tie var saskrāpēt virsmu, kā rezultātā stikls var saplīst.
5. Tīrīšanas padoms --- Lai vieglāk notīrītu kameras sienas, kurām var pieskarties pagatavotais ēdiens: levietojiet pusi citrona bļodā, pievienojiet 300 ml ūdens un 10 minūtes karsējiet ar 100% mikroviļņu jaudu. Noslaukiet cepeškrāsns tīru, izmantojot mīkstu, sausu drānu.

GALDA PIEDERUMI



UZMANĪBU

Personas savainojumu risks:
Ikvienam, kas nav kompetenta persona, ir bīstami veikt apkopes vai remonta darbības, kas ietver vāka noņemšanu, kas aizsargā pret mikroviļņu enerģijas iedarbību. Skatiet norādījumus sadaļā **“Materiāli, ko var izmantot mikroviļņu krāsnī”** vai **“Materiāli, ko nevar izmantot mikroviļņu krāsnī”**

Var būt daži nemetāliski trauki, kurus nav droši izmantot mikroviļņu krāsnī. Ja rodas šaubas, varat pārbaudīt attiecīgo trauku, veicot tālāk norādītās darbības.

Trauku pārbaude:

1. Piepildiet mikroviļņu krāsnī drošā traukā ar 1 glāzi auksta ūdens (250 ml) kopā ar attiecīgo trauku.
2. Gatavojiet ar maksimālo jaudu 1 min.
3. Uzmanīgi aptaustiet trauku. Ja tukšais trauks ir silts, neizmantojiet to gatavošanai mikroviļņu krāsnī.
4. Nepārsniedziet 1 minūti gatavošanas laiku.

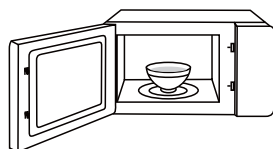

PIEZĪME

UZTURIET KAMERU UN
VIĻŅOTO ZONU TĪRU

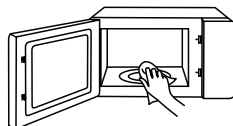

MATERIĀLI, KO VAR IZMANTOT MIKROVIĻŅU KRĀSNĪ

GALDA PIEDERUMI

PIEZĪMES



Brūnīšanas trauks

Izpildiet ražotāja norādījumus. Apbrūnīšanas trauka apakšai jābūt vismaz 5 mm virs grozāmās pamatnes. Nepareiza lietošana var izraisīt grozāmās pamatnes salūšanu.



Ēdienu trauki

Drošs tikai mikroviļņu krāsnī. Izpildiet ražotāja norādījumus. Neizmantojiet saplaisājušus vai iedrupušus traukus.



Stikla burkas

Vienmēr noņemiet vāku. Izmantojiet tikai, lai uzsildītu ēdienu, līdz tas ir silts. Lielākā daļa stikla burku nav karstumizturīgas un var saplīst.



Stikla trauki

Tikai karstumizturīgi cepeškrāsns stikla trauki. Pārlicinieties, vai nav metāla apdares. Neizmantojiet saplaisājušus vai iedrupušus traukus.



Cepeškrāsns gatavošanas maisiņi

Izpildiet ražotāja norādījumus. Neaizveriet ar metāla noslēgu. Izveidojiet iegriezumus, lai tvaiks varētu izplūst.



Papīra šķīvji un krūzes

Izmantojiet tikai īslaicīgai gatavošanai/sildīšanai. Gatavošanas laikā neatstājiet cepeškrāsni bez uzraudzības.



Papīra dvieļi

Izmantojiet, lai pārklātu pārtiku, lai uzsildītu un absorbētu taukus. Izmantojiet uzraudzībā tikai īslaicīgai gatavošanai.



Pergamenta papīra

Izmantojiet kā pārsegu, lai novērstu izšakstīšanos, vai aptinumu sautēšanai.



MATERIĀLI, KO VAR IZMANTOT MIKROVIĻŅU KRĀSNĪ

GALDA PIEDERUMI

PIEZĪMES



Plastmasa

Drošs tikai mikroviļņu krāsnī. Izpildiet ražotāja norādījumus. Jābūt marķētam "Drošs mikroviļņu krāsnī". Daži plastmasas trauki kļūst mīksti, ja iekšā esošais ēdiens kļūst karsts. "Vārīšanas maisi" un cieši noslēgti plastmasas maisiņi ir jāsgriež, jācaurdur vai jāvēdina, kā norādīts uz iepakojuma.



Plastmasas iesaiņojums

Drošs tikai mikroviļņu krāsnī. Izmantojiet, lai pārklātu ēdienu gatavošanas laikā, lai saglabātu mitrumu. Neļaujiet plastmasas iesaiņojumam pieskarties pārtikai.

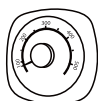

Termometri

Drošs tikai mikroviļņu krāsnī (gaļas un konfekšu termometri).



Vaska papīrs

Izmantojiet kā pārsegu, lai novērstu izšakstīšanos un saglabātu mitrumu.



MATERIĀLI, KO NEVAR IZMANTOT MIKROVIĻŅU KRĀSNĪ

GALDA PIEDERUMI

PIEZĪMES

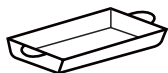

Alumīnija paplāte

Var izraisīt loka veidošanos. Ievietojiet pārtiku mikroviļņu krāsnī drošā traukā.



Pārtikas kastīte ar metāla rokturi

Var izraisīt loka veidošanos. Ievietojiet pārtiku mikroviļņu krāsnī drošā traukā.



Metāla vai metāla apdares trauki

Metāls ekranē pārtiku no mikroviļņu enerģijas. Metāla apdare var izraisīt loka veidošanos.



Metāla savilces

Var izraisīt loku un var izraisīt aizdegšanos cepeškrāsnī.



Papīra maisiņi

Var izraisīt aizdegšanos cepeškrāsnī.



Plastmasas putas

Plastmasas putas var izkausēt vai piesārņot iekšpusē esošo šķidrumu, pakļaujot to augstai temperatūrai.



Koksne

Koksne izžūs, kad to izmantos mikroviļņu krāsnī, un var plīst vai saplaisāt.



PRODUKTA IESTATĪŠANA

KRĀSNS IESTATĪŠANA

(Ja ir atšķirības starp ierīci un šajā rokasgrāmatā redzamajiem attēliem, noteicošais ir izstrādājums.)

MIKROVIĻŅU KRĀSNS DAĻU UN PIEDERUMU NOSAUKUMI

Izņemiet krāsni un visus materiālus no kartona kastes un krāsns iekšpusē.

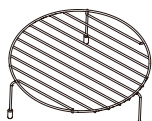

Augšējais grila plaukts

Grila plaukts (nedrīkst izmantot ar mikroviļņu funkciju un jānovieto uz stikla paplātes)

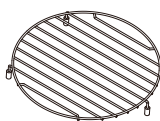

Apakšējais grila plaukts

Grila plaukts (nedrīkst izmantot ar mikroviļņu funkciju un jānovieto uz stikla paplātes)

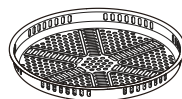

Cepšanas paplāte (nedrīkst izmantot kopā ar mikroviļņu krāsns funkciju, un to var novietot uz grila plaukta)



Stikla paplāte

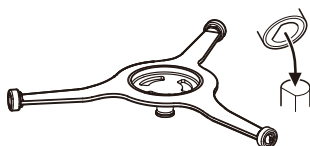

Rotējošās pamatnes riņķis



Lietošanas pamācība

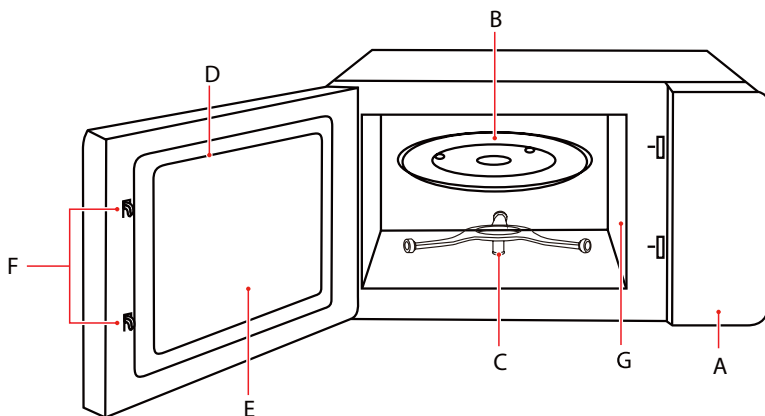

A) Vadības panelis

B) Stikla paplāte

C) Rotējošās pamatnes riņķis

D) Durvis

E) Novērošanas logs

F) Drošības bloķēšanas sistēma

G) Viļņvada pārsegis

KRĀSNS IESTATĪŠANA

ROTĒJOŠĀS PAMATNES UZSTĀDĪŠANA

Notīriet gatavošanas nodalījumu un novietojiet rotējošo pamatni.

Izmantojot jaunu ierīci, pārliecinieties, ka no rotējošās pamatnes vārpstas ir noņemts viss iepakojums un transportēšanas lente.

Pirms ierīces pirmās izmantošanas ēdiena gatavošanai pareizi jānovieto rotējošā pamatne. Jums ir jānotīra gatavošanas nodalījums un piederumi. Skatiet sadaļu par tīrīšanu.

Kā uzstādīt rotējošo pamatni:

1. Ievietojiet rotējošās pamatnes riņķi ② padziļinājumā gatavošanas nodalījumā.
2. Novietojiet stikla paplāti ① uz rotējošās pamatnes riņķa ②.

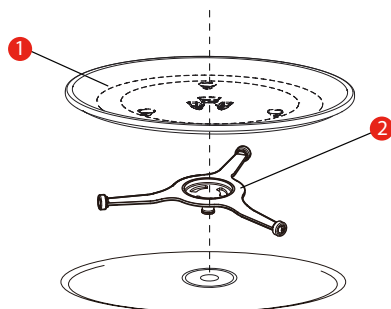

- 1) Stikla paplāte
- 2) Rotējošās pamatnes riņķis

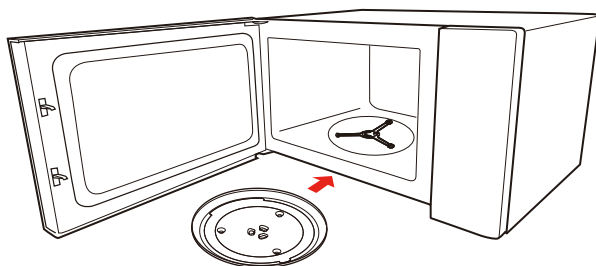

PIEZĪME

- Nekad nelietojiet ierīci bez rotējošās pamatnes. Pārliecinieties, ka tā ir pareizi nofiksēta. Rotējošā pamatne var griezties pulksteņrādītāju kustības virzienā vai pretēji pulksteņrādītāju kustības virzienam.
- Nekad nenovietojiet stikla paplāti otrādi. Stikla paplāti nekad nedrīkst ierobežot.
- Gatavošanas laikā vienmēr ir jāizmanto gan stikla paplāte, gan rotējošās pamatnes riņķis.
- Visi ēdieni un ēdiena trauki pirms gatavošanas vienmēr ir jānovieto uz stikla paplātes.
- Nekad neierobežojiet rotējošās pamatnes kustību.
- Ja stikla paplāte vai rotējošais riņķis saplīst, sazinieties ar tuvāko pilnvaroto servisa centru.

UZSTĀDĪŠANA UZ LETES

Noņemiet visus iepakojuma materiālus un piederumus. Pārbaudiet, vai krāsnij nav bojājumu, piemēram, iespiedumu vai salauztu durvju. Neuzstādiet, ja krāsns ir bojāta.

Korpuss: Noņemiet aizsargplēvi no mikroviļņu krāsns korpusa virsmas. Nenoņemiet viļņvada pārsegu, kas ir piestiprināts krāsns iekšienē, lai aizsargātu magnetronu.

UZSTĀDĪŠANA

1. Izvēlieties līdzenu virsmu, kas nodrošina pietiekami daudz brīvas vietas ieplūdes un/vai izplūdes atverēm.

a. Minimālais uzstādīšanas augstums ir 85 cm.

b. Ierīces aizmugurējo virsmu novietojiet pret sienu. Atstājiet vismaz 30 cm atstarpi virs krāsns.

Minimālais attālums starp krāsns un blakus esošajām sienām ir 20 cm.

c. Nenoņemiet kājas no krāsns apakšas.

d. Ieplūdes un/vai izplūdes atveru bloķēšana var sabojāt krāsns.

e. Novietojiet krāsns pēc iespējas tālāk no radio un televizora. Mikroviļņu krāsns darbība var radīt radio vai TV uztveršanas traucējumus.

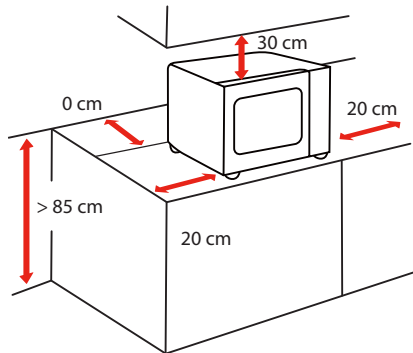

2. Pievienojiet mikroviļņu krāsns standarta kontaktligzdai. Pārlicinieties, ka spriegums un frekvence ir tādi paši kā spriegums un frekvence, kas norādīti uz parametru uzlīmes.



PIEZĪME

• Neuzstādiet krāsns virs plīts virsmas vai citas siltumu radošas ierīces.

Ja krāsns tiek uzstādīta tuvu siltuma avotam vai virs tā, tā var tikt bojāta un garantija anulēta.

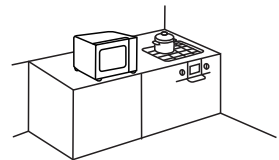

Pieejamā virsma darbības laikā var būt karsta.

LIETOŠANAS INSTRUKCIJA

PIRMS PIRMĀS LIETOŠANAS REIZES

Lietojot krāsni pirmo reizi, tā var radīt nepatīkamas smakas.

Šajā sadaļā ir aprakstīts, kas jums jā dara pirms mikroviļņu krāsns pirmās izmantošanas, lai pagatavotu ēdienu. Pirms tam izlasiet sadaļu "**PRODUKTA DROŠĪBA**".

Pirms jaunās ierīces lietošanas jums pareizi jānovieto rotējošā pamatne. Notīriet arī gatavošanas nodalījumu un piederumus.



PIEZĪME

- Nekad nelietojiet ierīci bez rotējošās pamatnes.
- Pārlicinieties, ka tā ir pareizi nofiksēta. Rotējošā pamatne var griezties pulksteņrādītāju kustības virzienā vai pretēji pulksteņrādītāju kustības virzienam.

LIETOŠANA

VADĪBAS PANELIS UN FUNKCIJAS

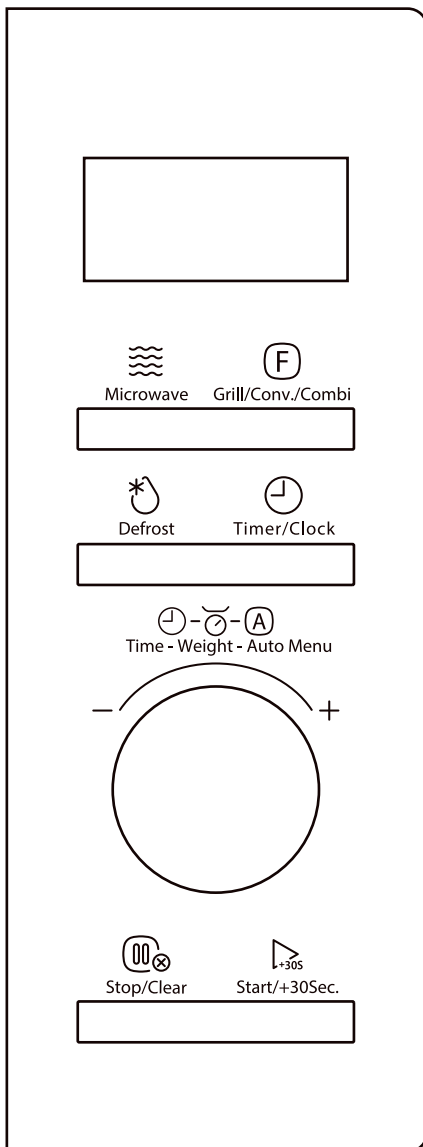



1. JAUDAS LĪMEŅI



Ir pieejami pieci jaudas līmeņi.

LĪMENIS	JAUDAS	DISPLEJS
1	100%	P100
2	80%	P80
3	50%	P50
4	30%	P30
5	10%	P10

2. PULKSTEŅA IESTATĪŠANA

Kad mikroviļņu krāsns ir pieslēgta kontaktligzdai, parādīsies "0:00".

- a**  Divreiz nospiežot **Timer/Clock**, parādās 00:00.
- b** Pagrieziet pogu, lai iestatītu stundas, ievadītajam laikam jābūt 0-23.
- c**   Nospiediet **Start/+30Sec.** vai **Timer/Clock**, lai apstiprinātu stundu skaitļus.
- d** Pagrieziet pogu, lai iestatītu minūtes, ievadītajam laikam jābūt 0-59.

e Nospiediet  Start/+30Sec. vai , lai apstiprinātu.



- Kad krāsns ir ieslēgta, ja pulkstenis nav iestatīts, tas nedarbosies.
- Pulksteņa iestatīšanas procesā, ja 5 minūšu laikā netiek veikta neviena darbība vai nospiests , displejs automātiski atgriezīsies pie iepriekšējā pulksteņa iestatījuma.

3. VIRTUVES TAIMERIS

Kad mikroviļņu krāsns ir pieslēgta kontaktligzdai, parādīsies "0:00".

a Nospiediet  Timer/Clock vienreiz



b Pagrieziet pogu, lai iestatītu laiku, tam jābūt no 0:05 līdz 95:00.



c Nospiediet  Start/+30Sec. , lai sāktu atpakaļskaitīšanu



- Virtuves taimera iestatījums atšķiras no pulksteņa iestatījuma; tas ir vienkārši taimeris.
- Virtuves taimera funkcijas laikā nevar iestatīt gatavošanas funkciju.

4. GATAVOŠANA MIKROVIĻŅU KRĀSNĪ

Kad mikroviļņu krāsnis ir pieslēgta kontaktligzdai, parādīsies "0:00".

Nospiediet  vairākas reizes, lai izvēlētos jaudas līmeni.

a vai

Nospiediet  vienreiz un pēc tam pagrieziet pogu, lai iestatītu jaudas līmeni

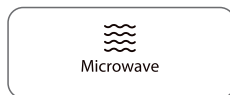

b Nospiediet  , lai apstiprinātu jaudas līmeni.



c Pagrieziet pogu, lai iestatītu laiku, maksimālā laika vērtība ir "95:00".



d Nospiediet  , lai sāktu gatavošanu.



5. GRILS VAI KOMBINĀCIJA

Nospiediet  vairākas reizes, lai izvēlētos režīmu.

a vai

Nospiediet  vienreiz un pēc tam pagrieziet pogu, lai izvēlētos režīmu.

"G-1, C-1...C-4, 150 ° C, 160 ° C.....240 ° C" parādīsies secībā. ("G-1" ir grils, "C-1~C-4" ir kombinācija).



b Nospiediet  Start/+30Sec. , lai apstiprinātu režīmu.



c Pagrieziet pogu, lai iestatītu laiku, maksimālā laika vērtība ir "95:00".

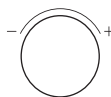

d Nospiediet  Start/+30Sec. , lai sāktu gatavošanu.



PIEZĪME

• Kad puse no laika ir pagājusi, atskan zummers, lai atgādinātu, ka grila funkcijas laikā ēdiens ir jāapgriež. Ja darbības netiek veiktas, krāsns turpinās darboties.

6. KONVEKCIJA AR PRIEKŠSILDĪŠANU

a Nospiediet  Grill/Conv./Combi vairākas reizes, lai izvēlētos konvekcijas temperatūru.



a vai
Nospiediet  Grill/Conv./Combi vienreiz un pēc tam pagrieziet pogu, lai izvēlētos konvekcijas temperatūru.
150°C, 160°C.....240°C ir pieejami.



b Nospiediet  Start/+30Sec. divreiz, lai sāktu priekšsildīšanu. Kad priekšsildīšana ir pabeigta, temperatūra mirgo, atveriet durvis un ievietojiet ēdienu krāsni.



c Pagrieziet pogu, lai iestatītu laiku, maksimālā laika vērtība ir "95:00".

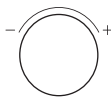

d Nospiediet  Start/+30Sec. , lai sāktu gatavošanu.



7. KONVEKCIJA BEZ PRIEKŠILDĪŠANAS

f Nospiediet  Grill/Conv./Combi vairākas reizes, lai izvēlētos konvekcijas temperatūru.



a vai

f Nospiediet  Grill/Conv./Combi vienreiz un pēc tam pagrieziet pogu, lai izvēlētos konvekcijas temperatūru.
150°C, 160°C.....240°C ir pieejami.



b Nospiediet  Start/+30Sec. , lai apstiprinātu temperatūru.



c Pagrieziet pogu, lai iestatītu laiku, maksimālā laika vērtība ir "95:00".

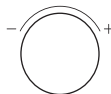



d Nospiediet  Start/+30Sec. , lai sāktu gatavošanu.

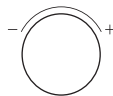

8. GAISA FRITĒŠANAS IZVĒLNE

- a** Gaidīšanas stāvoklī pagrieziet pogu pa labi, lai aktivizētu izvēlnes funkciju.
Atkārtoti pagrieziet pogu, lai izvēlētos izvēlni H-1.



- b** Nospiediet  Start/+30Sec., lai apstiprinātu izvēlnes veidu



- c** Pagrieziet pogu, lai izvēlētos apakšizvēlni.

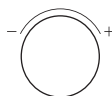

- d** Nospiediet  Start/+30Sec., lai sāktu gatavošanu.



GAISA FRITĒŠANAS IZVĒLNES SHĒMA

DISPLEJS	IZVĒLNE	SVARS
H-1	Saldēti frī kartupeļi	300 g
H-2	Saldētas kartupeļu kroketes	350 g
H-3	Saldēti kalmāri	250 g
H-4	Saldēti sīpolu gredzeni	250 g
H-5	Saldēti vistas nageti	350 g
H-6	Eskalops	400 g
H-7	Garneles	250 g
H-8	Dārzeni	200 g
H-9	Pavasara rulliši	300 g

Piezīme: Gaisa fritēšanas izvēlnē svaru nevar iestatīt.

9. AUTOMĀTISKĀ IZVĒLNE UN KRAUKŠĶĪGĀ GRILA IZVĒLNE

- a** Gaidīšanas stāvoklī pagrieziet pogu pa labi, lai aktivizētu izvēlnes funkciju. Atkārtoti pagrieziet pogu, lai izvēlētos automātisko izvēlni (displejs A-1) vai kraukšķīgā grila izvēlni (displejs C-1). Piemēram, izvēlieties C-1.

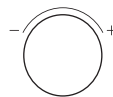

- b** Nospiediet  Start/+30Sec., lai apstiprinātu.



- c** Pagrieziet pogu, lai izvēlētos apakšizvēlni, C-1~C-4 ir pieejami.

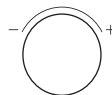

- d** Nospiediet  Start/+30Sec., lai apstiprinātu. Pagrieziet pogu, lai izvēlētos svaru C-3 un C-4 svaru nevar iestatīt.



- e** Nospiediet  Start/+30Sec., lai apstiprinātu.



KRAUKŠĶĪGĀ GRILA IZVĒLNES SHĒMA

DISPLEJS	IZVĒLNE	SVARS
C-1	Cordon bleu	300 g
		600 g
		900 g
C-2	lazanja	200 g
		300 g
		400 g
		500 g
C-3	maize	100 g
C-4	pīrāgs/kūka	8 (aptuveni 350 g)

AUTOMĀTISKĀS IZVĒLNES SHĒMA

IZVĒLNE	DISPLEJS	SVARS/ DAUDZUMS	JAUDAS LĪMENIS
A-1 AUTOMĀTISKA UZSILDĪŠANA	150 g	150 g	P100
	250 g	250 g	
	350 g	350 g	
	450 g	450 g	
	600 g	600 g	
A-2 KARTUPEĻI	1	1 (apmēram 230 g)	P100
	2	2	
	3	3	
A-3 GAĻA	150 g	150 g	P80
	300 g	300 g	
	450 g	450 g	
	600 g	600 g	
A-4 DĀRZEŅI	150 g	150 g	P100
	350 g	350 g	
	500 g	500 g	
A-5 ZIVIS	150 g	150 g	P80
	250 g	250 g	
	350 g	350 g	
	450 g	450 g	
	650 g	650 g	
A-6 MAKĀRONU IZSTRĀDĀJUMI	50 g (ar aukstu ūdeni 450 g)	50 g	P80
	100 g (ar aukstu ūdeni 800 g)	100 g	
	150 g (ar aukstu ūdeni 1200 g)	150 g	
A-7 ZUPA	200 g	200 g	P100
	400 g	400 g	
	600 g	600 g	
A-8 KŪKA	475 g	475 g	CONVEC.160°C (Ar priekšsildīšanu 160°C)
A-9 PICA	100 g	100 g	C-4
	200 g	200 g	
	300 g	300 g	
A10 VISTAS GAĻA	500 g	500 g	C-4
	750 g	750 g	
	1000 g	1000 g	
	1200 g	1200 g	

10. ATKAUSĒŠANA PĒC SVARA

- a** Nospiediet  Defrost vienreiz, parādīsies "dEF1".



- b** Pagrieziet pogu, lai iestatītu ēdiena svaru, tam jābūt "100 g-2000 g" robežās.

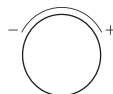

- c** Nospiediet  Start/+30Sec., lai sāktu atkausēšanu.



PIEZĪME

- Zummers atskanēs divreiz, lai atgādinātu jums apgriezt ēdienu atkausēšanas laikā.

11. ATKAUSĒŠANA PĒC LAIKA

- a** Nospiediet  Defrost divreiz, parādīsies "dEF2".

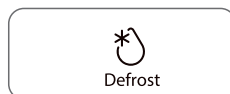

- b** Pagrieziet pogu, lai iestatītu laiku, maksimālā laika vērtība ir "95:00".

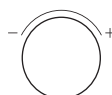

- c** Nospiediet  Start/+30Sec. , lai sāktu atkausēšanu.



- Kad puse laika ir pagājusi, atskan zummers, lai atgādinātu jums apgriezt ēdienu.
- Noklusējuma jaudas līmenis ir P30, to nevar mainīt.

12. VAIRĀKPOSMU GATAVOŠANA

- a** Nospiediet  Defrost divreiz, parādīsies "dEF2".



- b** Pagrieziet pogu, lai iestatītu laiku, maksimālā laika vērtība ir "95:00".



- c** Nospiediet  Grill/Conv./Combi , lai izvēlētos gatavošanas režīmu.



- d** Nospiediet  Start/+30Sec. , lai apstiprinātu.



- e** Pagrieziet pogu, lai iestatītu laiku, maksimālā laika vērtība ir "95:00".

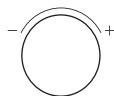

- f** Nospiediet  Start/+30Sec. , lai sāktu gatavošanu.



PIEZĪME

- Vairākpосmu gatavošanā var iestatīt divus gatavošanas posmus.
- Ja iestatāt atkausēšanas funkciju, tā darbosies automātiski pirmajā posmā.
- Virtuves taimeris, automātisko izvēlni, gatavošanas ātrumu un priekšsildīšanu nevar iestatīt kā vienu no vairākpосmu iestatījumiem.

13. ĀTRA GATAVOŠANA

- a** Pagrieziet pogu pa kreisi vienu reizi, lai izvēlētos gatavošanas režīmu ar 100% jaudas līmeni 5 sekundes.

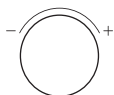

- b** Pagrieziet pogu, lai iestatītu laiku, maksimālā laika vērtība ir "95:00".

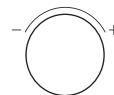

- c** Nospiediet  Start/+30Sec. , lai sāktu gatavošanu.



- a** Nospiediet  Start/+30Sec. vienu reizi, lai gatavotu ar 100% jaudas līmeni 30 sekundes.



14. BLOKĒŠANAS FUNKCIJA

- a** Lai nobloķētu mikroviļņu krāsni tā, lai to nevarētu darbināt bērni vai citi neparedzēti lietotāji, nospiediet un 3 sekundes turiet nospiestu  ; tiks parādīta bloķētā ikona.



- b** Lai atbloķētu, nospiediet  un turiet nospiestu 3 sekundes.



15. IZZIŅAS FUNKCIJA

- a** Kad krāsni notiek gatavošana, nospiediet  Timer/Clock, displejā uz trim sekundēm parādās pašreizējais laiks.



TĪRĪŠANA

Labi kopjot un tīrot, jūsu ierīce saglabās savu izskatu un funkcionētspēju ilgu laiku. Šeit mēs paskaidrosim, kā pareizi kopt un tīrīt ierīci.



BRĪDINĀJUMS

- Ierīces durvju stikla skrāpējums var izveidoties par plaisu. Neizmantojiet stikla skrāpi, asus vai abrazīvus tīrīšanas līdzekļus vai mazgāšanas līdzekļus.
- Ierīces virsma var tikt bojāta, ja tā netiek pareizi tīrīta. Var izplūst mikroviļņu enerģija. Regulāri tīriet ierīci un nekavējoties noņemiet pārtikas paliekas.
- Neiegremdējiet ierīci ūdenī un netīriet to zem ūdens strūkļas.

Tīrīšanas līdzeklis

Lai nodrošinātu, ka dažādas virsmas netiek bojātas, izmantojot nepareizu tīrīšanas līdzekli, ievērojiet tālāk sniegto informāciju. Pirms lietošanas rūpīgi nomazgājiet jaunas sūkļa drānas.

Nelietojiet:



Agresīvi vai abrazīvie
tīrīšanas līdzekļi



Metāla vai stikla skrāpji
durvju paneļu tīrīšanai



Metāla vai stikla skrāpji
durvju blīvējuma tīrīšanai



Cieti beršanas
spilventiņi vai sūkļi



Tīrīšanas līdzekļi ar
augstu spirta saturu

IERĪCES PRIEKŠPUSE

Karsts ziepjūdens:

Notīriet, izmantojot trauku lupatiņu, un pēc tam nosusiniet ar mikstu drāniņu. Tīrīšanai neizmantojiet metāla vai stikla skrāpjus.

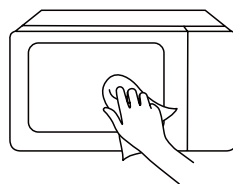

TĪRĪŠANA

IERĪCES PRIEKŠĒJĀ PLĀKSNE

Karsts ziepjūdens:

Notīriet, izmantojot trauku lupatiņu, un pēc tam nosusiniet ar mīkstu drāniņu.

Nekavējoties noņemiet kaļķakmens, tauku, cietes un organisko vielu šķakatas un plankumus. Zem šiem plankumiem vai šķakatām var veidoties korozija. Tīrīšanai neizmantojiet stikla tīrīšanas līdzekļus vai metāla vai stikla skrāpjus.

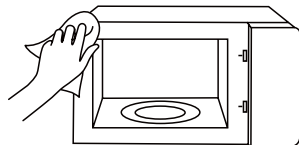

IERĪCES KAMERA

Karsts ziepjūdens vai etiķa šķīdums:

Notīriet, izmantojot trauku lupatiņu, un pēc tam nosusiniet ar mīkstu drāniņu. Neizmantojiet cepeškrāsns aerosolu vai citus agresīvus cepeškrāsns tīrīšanas līdzekļus vai abrazīvus materiālus. Nav piemēroti arī tīrīšanas spilventiņi, raupji sūkļi un pannu tīrīšanas līdzekļi. Šie priekšmeti saskrāpē virsmu. Ļaujiet iekšējām virsmām pilnībā nožūt.

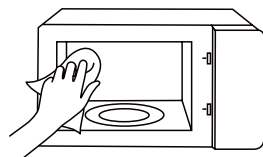

IEDOBE GATAVOŠANAS KAMERĀ

Mitra lupata:

Ūdenim nedrīkst ļaut iekļūst ierīcē caur grozāmās pamatnes piedziņu. Nosusiniet grozāmās pamatnes piedziņu ar drānu.

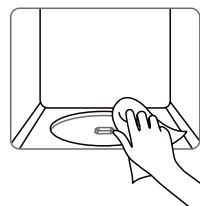

GROZĀMĀ PAMATNE UN GREDZENS

Karsts ziepjūdens:

Grozāmo pamatni padziļinājumā, tai ir pareizi jānofiksējas.



DURVJU PANELIS

Stikla tīrītājs:

Notīriet ar trauku lupatiņu. Neizmantojiet stikla skrāpjus.

APKOPE

PROBLĒMU NOVĒRŠANA

Pārbaudiet savu problēmu, izmantojot tālāk redzamo tabulu, un izmēģiniet katras problēmas risinājumus.

Ja mikroviļņu krāsns joprojām nedarbojas pareizi, sazinieties ar tuvāko pilnvaroto servisa centru.

PROBLĒMAS	IESPĒJAMĀS CĒĻONIS	IESPĒJAMS RISINĀJUMS
Cepeškrāsns nesāk darboties	<ol style="list-style-type: none">Cepeškrāsns elektrības vads nav pievienots.Durvis ir atvērtas.Iestatīta nepareiza darbība.	<ol style="list-style-type: none">Pieslēdziet kontaktligzdai.Aizveriet durvis un mēģiniet vēlreiz.Pārbaudiet instrukcijas
Loks vai dzirksteļošana	<ol style="list-style-type: none">Tika izmantoti materiāli, no kuriem mikroviļņu krāsni jāizvairās.Cepeškrāsns tiek darbināta, kad tā ir tukša.Izšļakstītās pārtikas paliekas kamerā.	<ol style="list-style-type: none">Izmantojiet tikai mikroviļņu krāsni piemērotus virtuves traukus.Nedarbiniet, ja krāsns ir tukša.Notīriet kameru ar mitru dvieli.
Nevienmērīgi pagatavoti ēdieni	<ol style="list-style-type: none">Tika izmantoti materiāli, no kuriem mikroviļņu krāsni jāizvairās.Pārtika nav pilnībā atkausēta.Gatavošanas laiks, jaudas līmenis nav piemērots.Ēdiens netiek apgriezts vai maisīts.	<ol style="list-style-type: none">Izmantojiet tikai mikroviļņu krāsni piemērotus virtuves traukus.Pilnībā atkausējiet pārtiku.Izmantojiet pareizo gatavošanas laiku, jaudas līmeni.Apgrieziet vai samaisiet ēdienu.
Pārgatavoti ēdieni	Gatavošanas laiks, jaudas līmenis nav piemērots.	Izmantojiet pareizo gatavošanas laiku, jaudas līmeni.
Nepietiekami termiski apstrādāti ēdieni	<ol style="list-style-type: none">Tika izmantoti materiāli, no kuriem mikroviļņu krāsni jāizvairās.Pārtika nav pilnībā atkausēta.Krāsns ventilācijas atveres ir ierobežotas.Gatavošanas laiks, jaudas līmenis nav piemērots.	<ol style="list-style-type: none">Izmantojiet tikai mikroviļņu krāsni piemērotus virtuves traukus.Pilnībā atkausējiet pārtiku.Pārbaudiet, vai krāsns ventilācijas atveres nav ierobežotas.Izmantojiet pareizo gatavošanas laiku, jaudas līmeni
Nepareiza atkausēšana	<ol style="list-style-type: none">Tika izmantoti materiāli, no kuriem mikroviļņu krāsni jāizvairās.Gatavošanas laiks, jaudas līmenis nav piemērots.Ēdiens netiek apgriezts vai maisīts.	<ol style="list-style-type: none">Izmantojiet tikai mikroviļņu krāsni piemērotus virtuves traukus.Izmantojiet pareizo gatavošanas laiku, jaudas līmeni.Apgrieziet vai samaisiet ēdienu.



Saskaņā ar elektrisko un elektronisko iekārtu atkritumu (EEIA) direktīvu EEIA jāsavāc un jāapstrādā atsevišķi. Ja nākotnē jums vajadzēs atbrīvoties no šī izstrādājuma, lūdzu, neizmetiet šo izstrādājumu kopā ar sadzīves atkritumiem. Lūdzu, nosūtiet šo produktu uz EEIA savākšanas punktiem, kur tie ir pieejami.

#DetailsMatter